



US00D784741S

(12) **United States Design Patent** (10) **Patent No.:** **US D784,741 S**  
**Mann** (45) **Date of Patent:** **\*\* Apr. 25, 2017**

- (54) **TABLE**
- (71) Applicant: **Kohler Interiors Furniture Company**,  
Hickory, NC (US)
- (72) Inventor: **Kara Mann**, New York, NY (US)
- (73) Assignee: **KOHLER CO.**, Kohler, WI (US)
- (\*\*) Term: **15 Years**
- (21) Appl. No.: **29/542,794**
- (22) Filed: **Oct. 16, 2015**
- (51) **LOC (10) Cl.** ..... **06-04**
- (52) **U.S. Cl.**  
USPC ..... **D6/691**; D6/656.16
- (58) **Field of Classification Search**  
USPC .... D6/691, 692, 656, 656.13, 656.16, 695.3,  
D6/708  
CPC ..... A47B 3/00; A47B 3/0818; A47B 3/087;  
A47B 57/00; A47B 57/06; A47B 7/00;  
A47B 7/06; A47B 13/00; A47B 13/02;  
A47B 13/04  
See application file for complete search history.

D711,171 S *	8/2014	Brielmaier	.....	D6/675
D734,964 S *	7/2015	Ward	.....	D6/656.1
D735,505 S *	8/2015	Baraldi	.....	D6/690
D757,470 S *	5/2016	Pedersen	.....	D6/686
2016/0081468 A1 *	3/2016	Molteni	.....	A47B 9/00 108/147

\* cited by examiner

*Primary Examiner* — Robin V Webster  
*Assistant Examiner* — James Thorn, Sr.  
(74) *Attorney, Agent, or Firm* — Foley & Lardner LLP

(57) **CLAIM**

I claim the ornamental design for a table, as shown and described.

**DESCRIPTION**

FIG. 1 is a top perspective view of an embodiment of the claimed design;  
 FIG. 2 is another top perspective view of the embodiment shown in FIG. 1;  
 FIG. 3 is a top plan view of the embodiment shown in FIG. 1;  
 FIG. 4 is a bottom plan view of the embodiment shown in FIG. 1;  
 FIG. 5 is a first side view of the embodiment shown in FIG. 1;  
 FIG. 6 is a second side view of the embodiment shown in FIG. 1;  
 FIG. 7 is a third side view of the embodiment shown in FIG. 1; and,  
 FIG. 8 is a fourth side view of the embodiment shown in FIG. 1.  
 The ornamental design which is claimed is shown in solid lines in the drawings. The broken lines in the drawings are for illustrative purposes only and form no part of the claimed design.

**1 Claim, 7 Drawing Sheets**

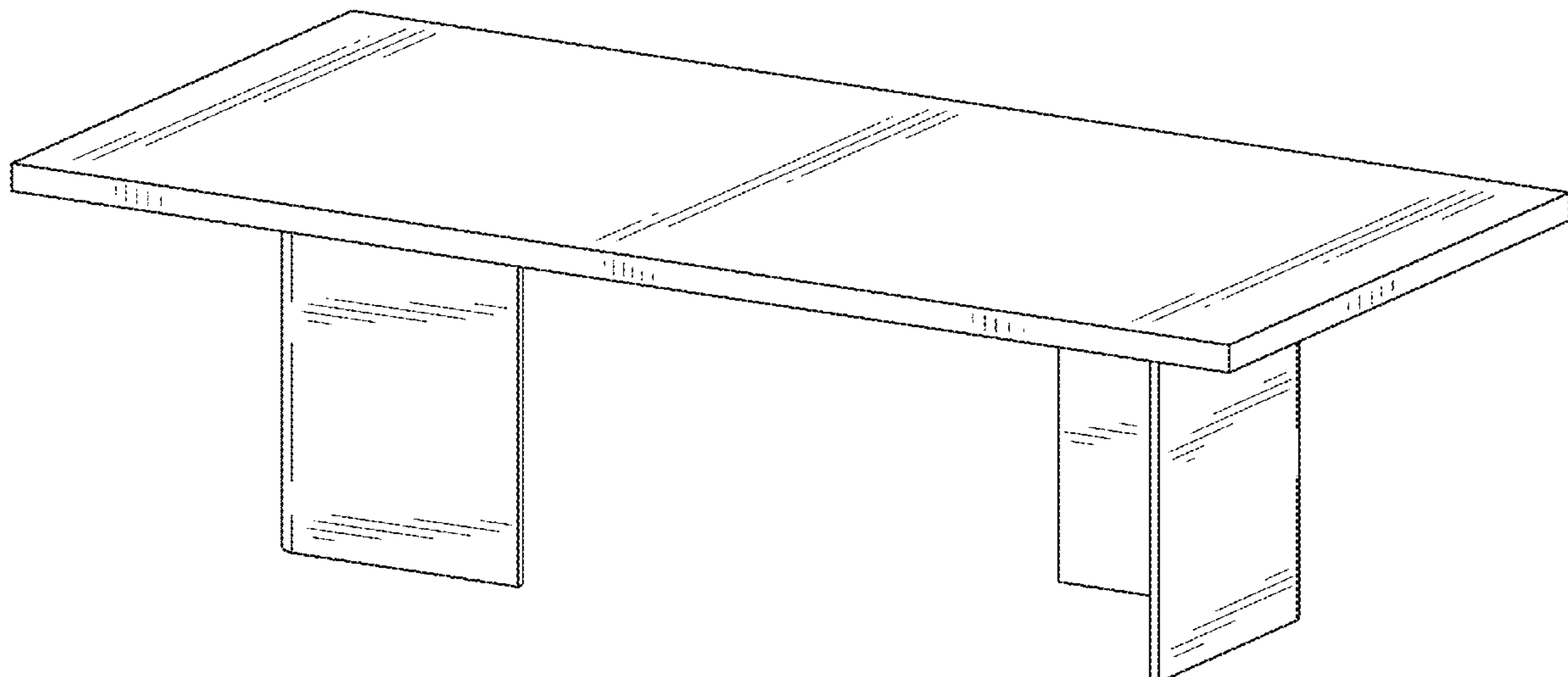

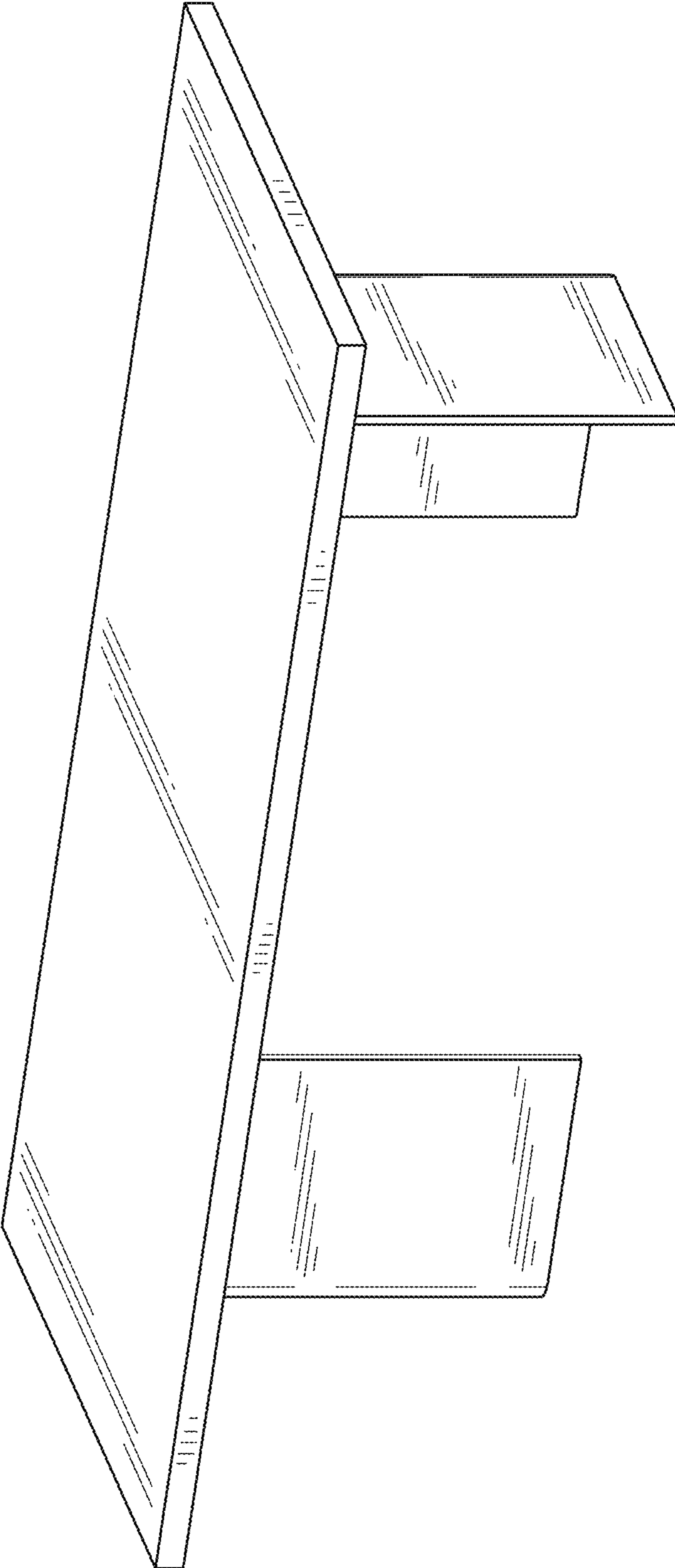

FIG. 1

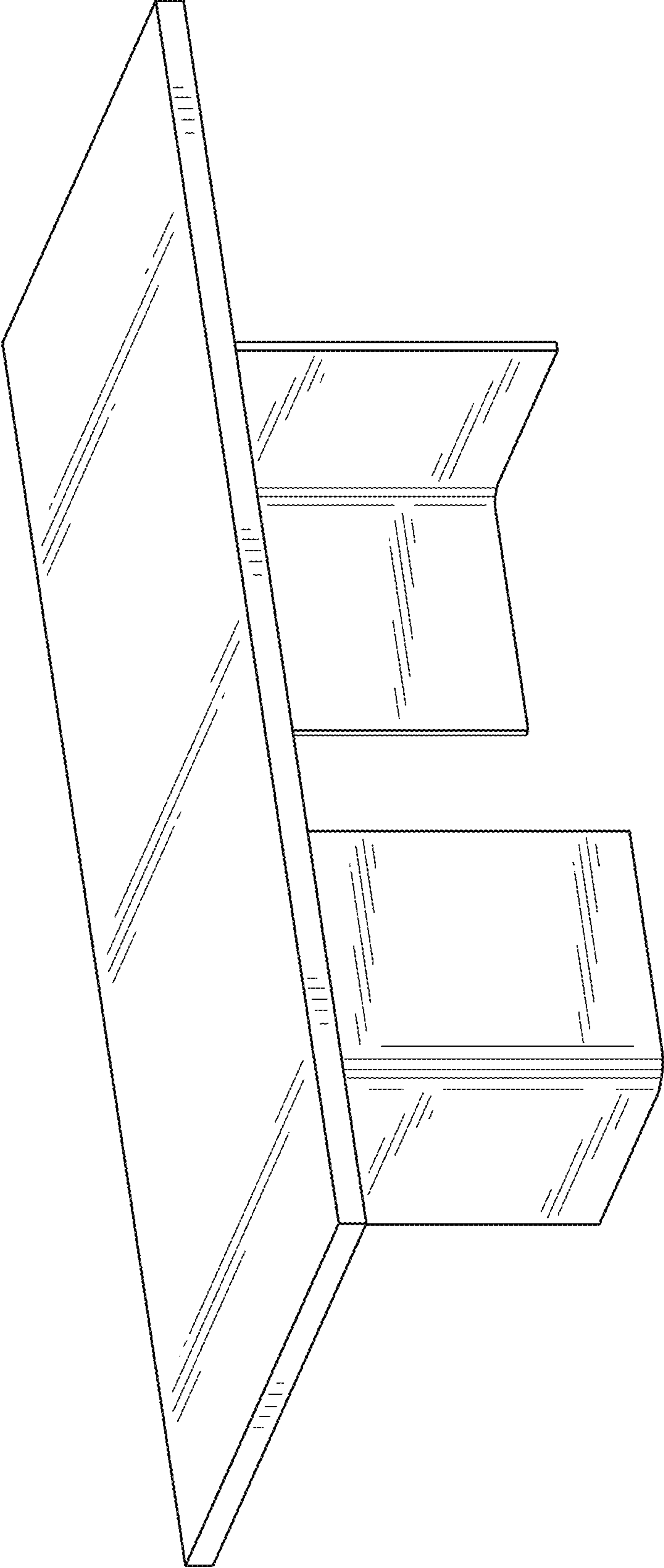

FIG. 2

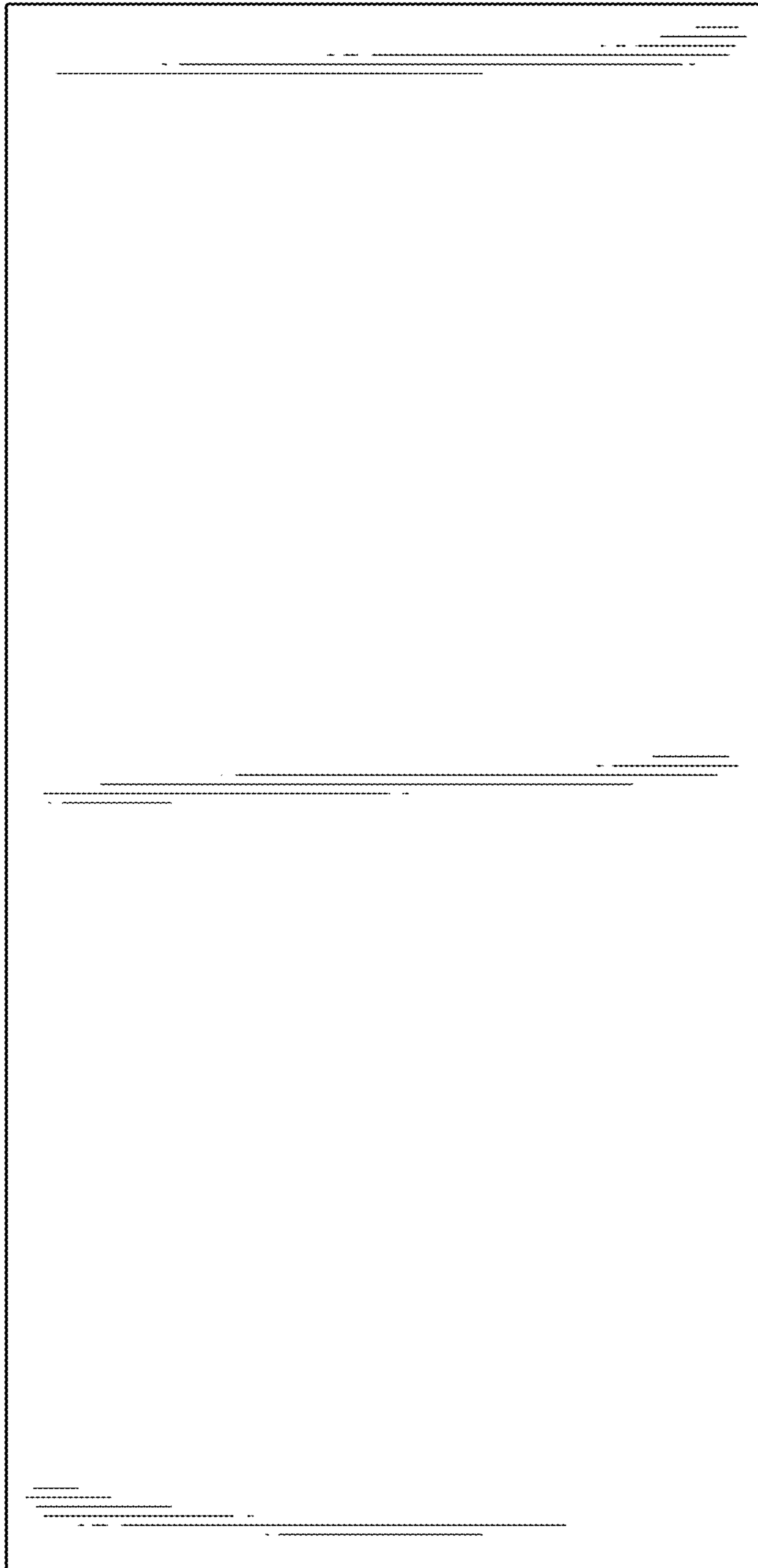

FIG. 3

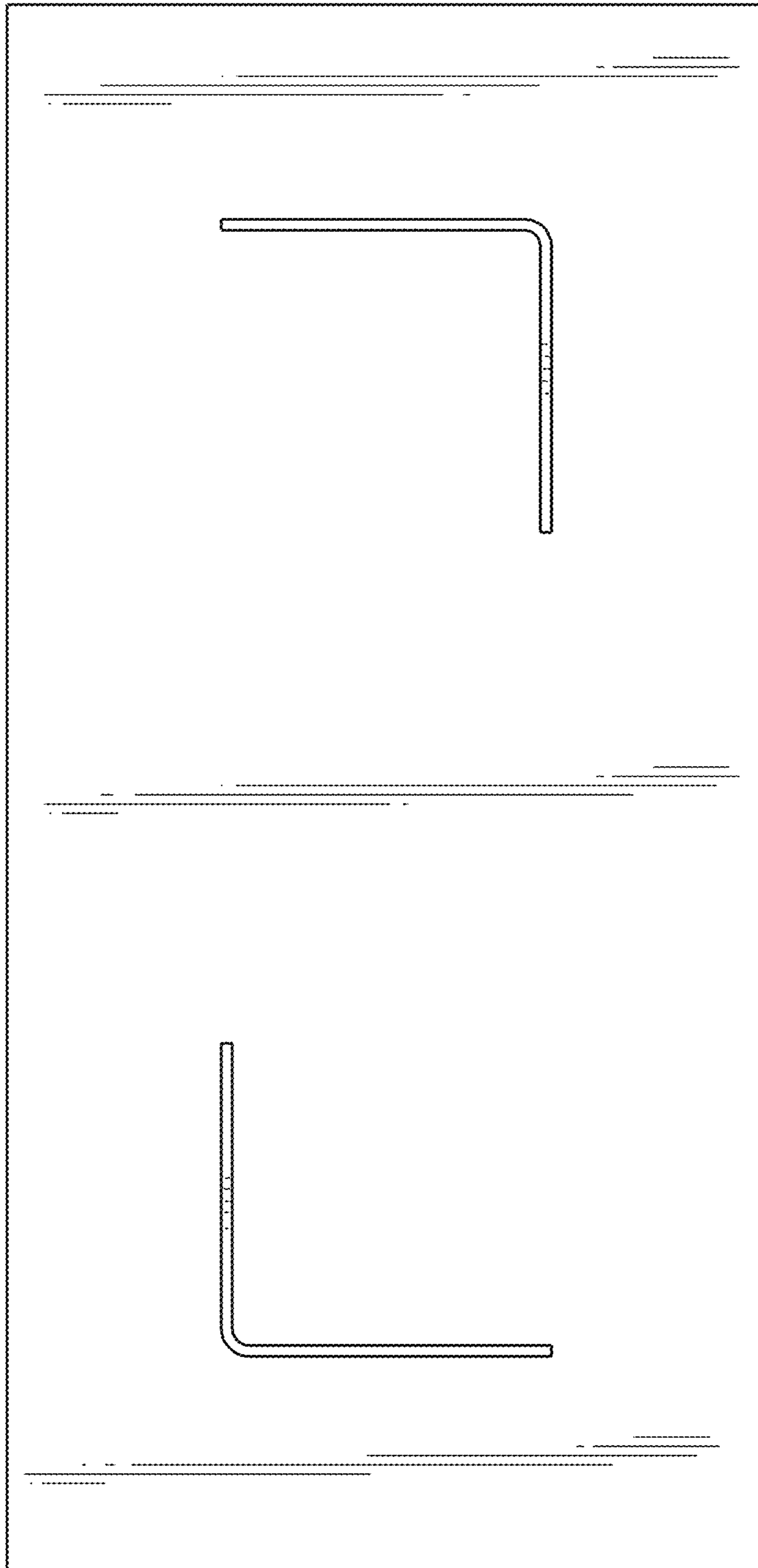

FIG. 4

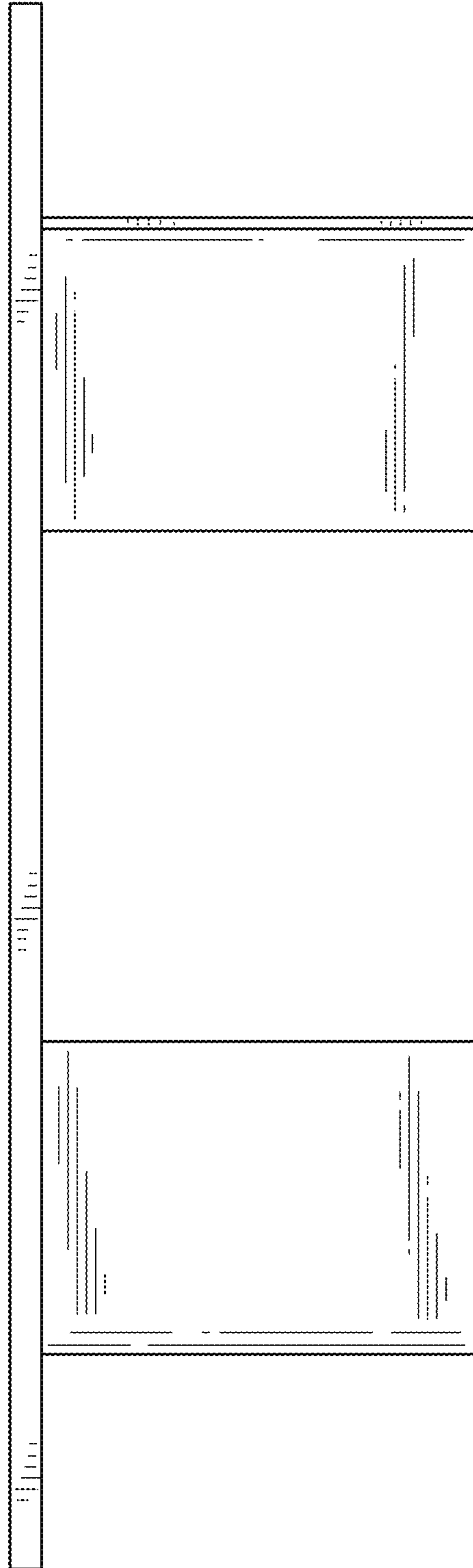

FIG. 5

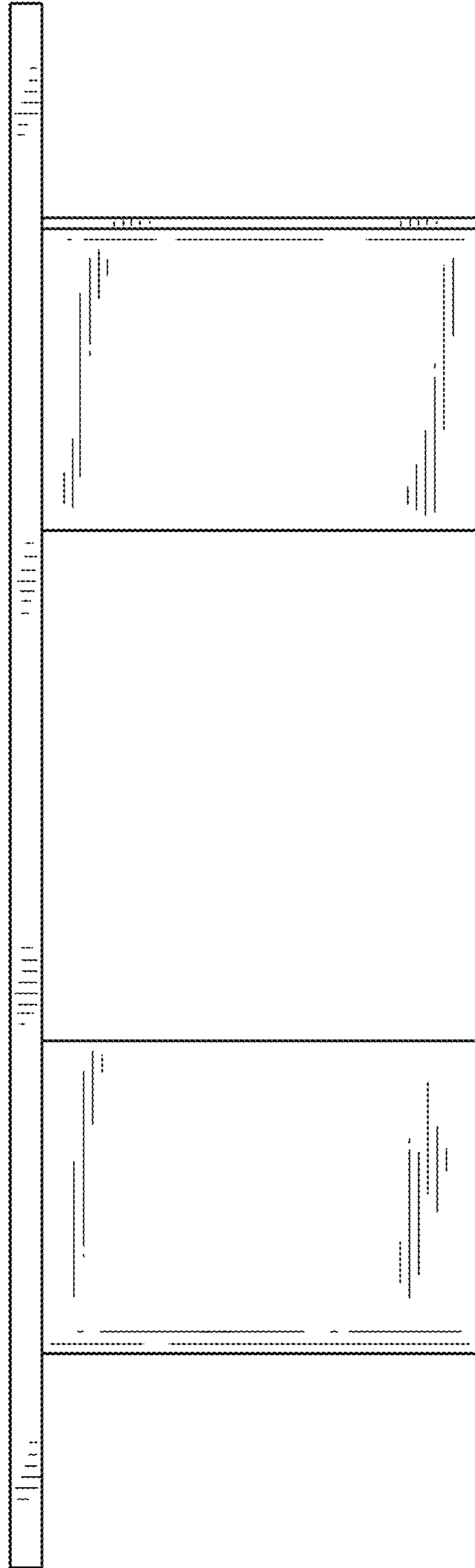

FIG. 6

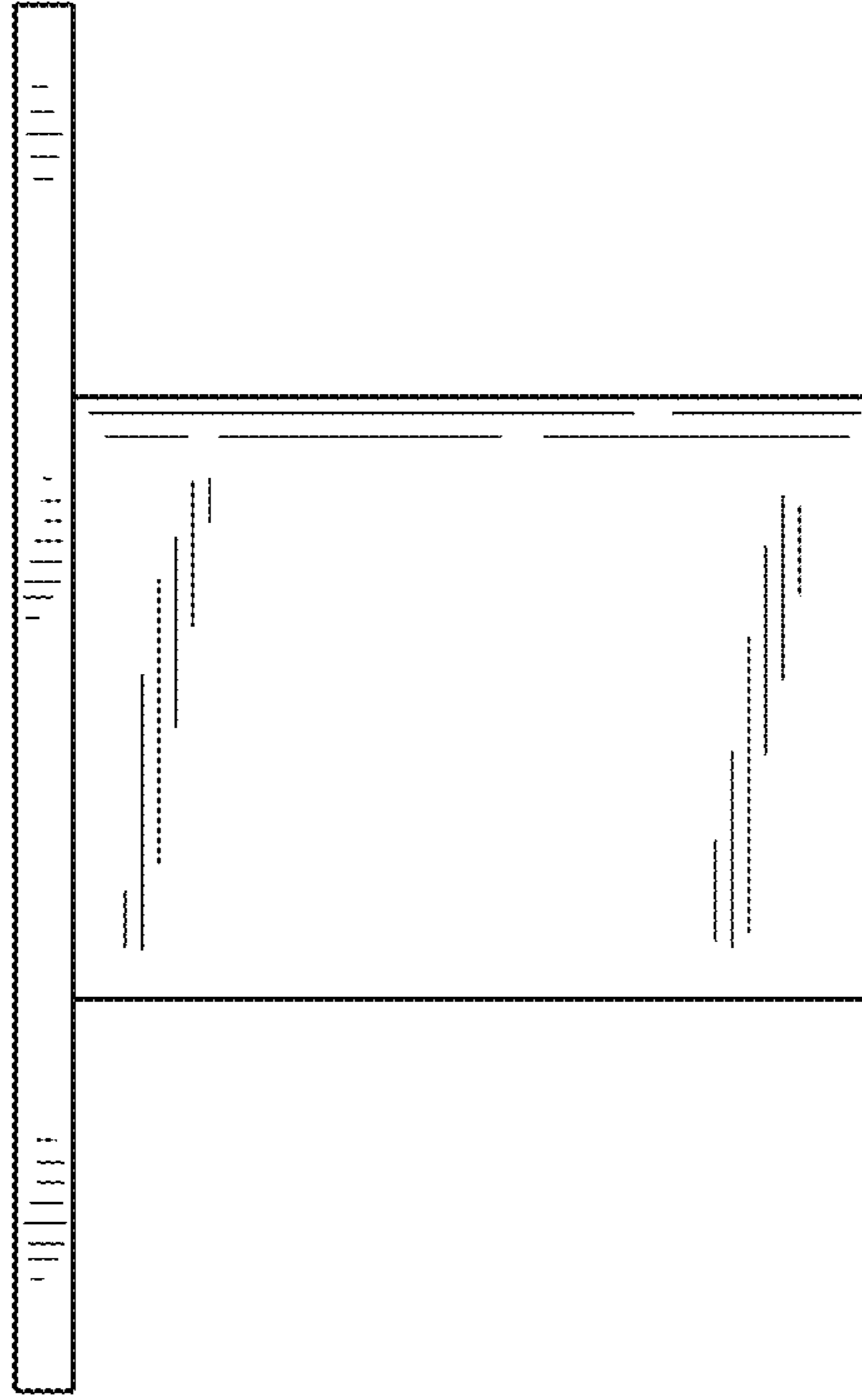

FIG. 7

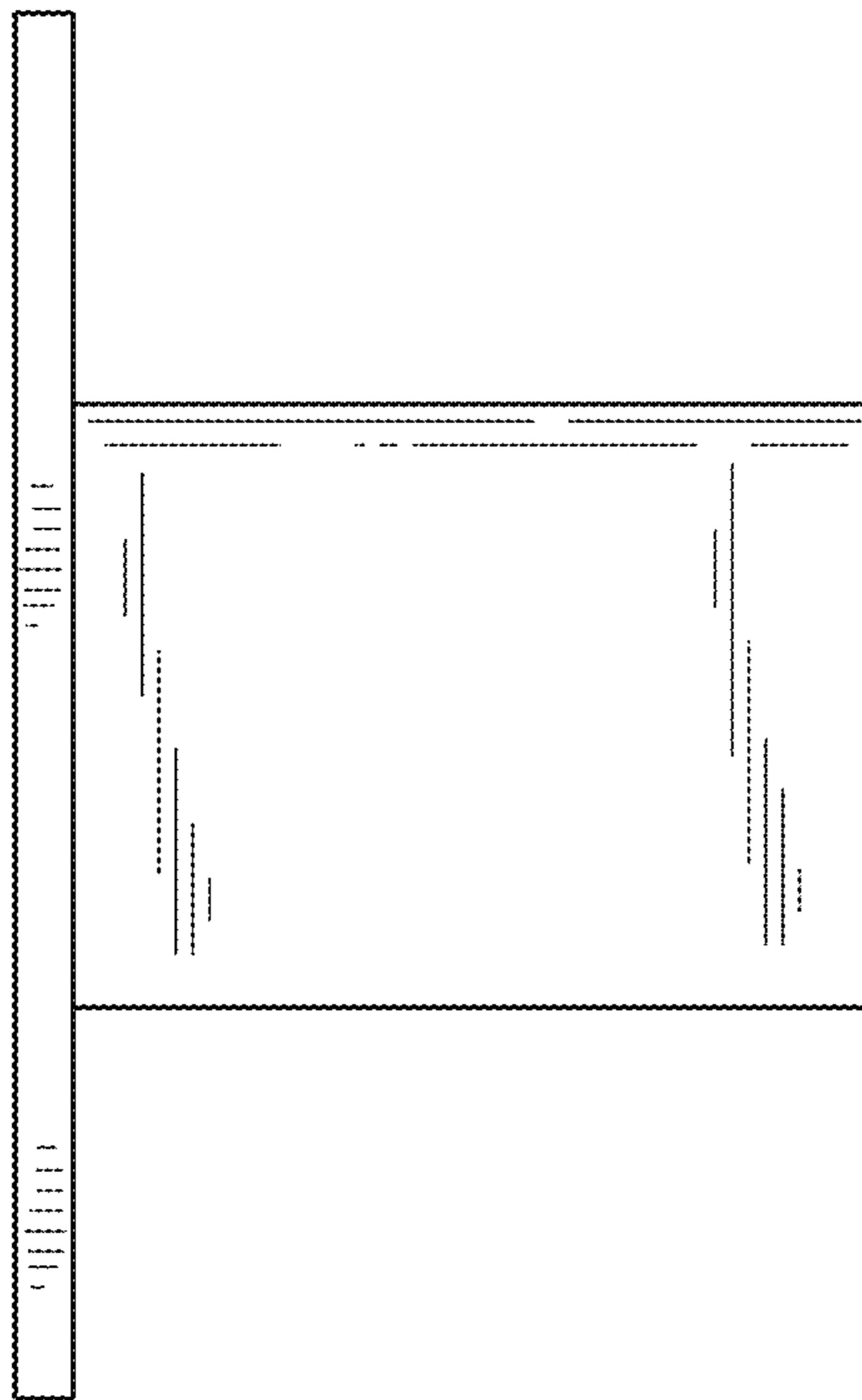

FIG. 8