



US00D784516S

(12) **United States Design Patent**  
**Prentice et al.**

(10) **Patent No.:** **US D784,516 S**  
(45) **Date of Patent:** **\*\* Apr. 18, 2017**

(54) **FACE MASK FRAME**

(71) Applicant: **Fisher & Paykel Healthcare Limited**,  
Auckland (NZ)

(72) Inventors: **Craig Robert Prentice**, Auckland (NZ);  
**Bernard Tsz Lun Ip**, Auckland (NZ);  
**Mark Arvind McLaren**, Auckland  
(NZ); **Kyle Gregory Brown**, Auckland  
(NZ); **Chris Onin Limpin Hipolito**,  
Auckland (NZ); **Mark Richard**  
**Tomlinson**, Auckland (NZ); **Melissa**  
**Catherine Bornholdt**, Auckland (NZ)

(73) Assignee: **FISHER & PAYKEL HEALTHCARE**  
**LIMITED**, Auckland (NZ)

(\*\*) Term: **15 Years**

(21) Appl. No.: **29/540,693**

(22) Filed: **Sep. 25, 2015**

(51) **LOC (10) Cl.** ..... **29-02**

(52) **U.S. Cl.**  
USPC ..... **D24/110.4**

(58) **Field of Classification Search**  
USPC ..... D24/110-110.5, 127, 164  
(Continued)

(56) **References Cited**

**U.S. PATENT DOCUMENTS**

D383,204 S 9/1997 Lomas et al.  
6,631,718 B1 10/2003 Lovell et al.  
(Continued)

**OTHER PUBLICATIONS**

Fisher & Paykel Announces Eson 2 Mask at Investor Day. Sleep  
Review. Oct. 12, 2015. <<http://www.sleepreviewmag.com/2015/10/fisher-paykel-announces-eson-2-mask-investor-day/>>.\*  
(Continued)

*Primary Examiner* — Barbara Fox

*Assistant Examiner* — Lilyana Bekic

(74) *Attorney, Agent, or Firm* — Knobbe, Martens, Olson  
& Bear, LLP

(57) **CLAIM**

The ornamental design for a face mask frame, as shown and  
described.

**DESCRIPTION**

The file of this patent contains at least one drawing/photo-  
graph executed in color. Copies of this patent with color  
drawing(s)/photograph(s) will be provided by the Office  
upon request and payment of the necessary fee.

FIG. 1 is a top, front and side perspective view of a first  
embodiment of a face mask frame embodying our new  
design;

FIG. 2 is a top, rear and side perspective view thereof;

FIG. 3 is a front view thereof;

FIG. 4 is a rear view thereof;

FIG. 5 is a first side view thereof;

FIG. 6 is a second side view thereof;

FIG. 7 is a top view thereof; and

FIG. 8 is a bottom view thereof.

FIG. 9 is a top, front and side perspective view of a second  
embodiment of a face mask frame embodying our new  
design;

FIG. 10 is a top, rear and side perspective view thereof;

FIG. 11 is a front view thereof;

FIG. 12 is a rear view thereof;

FIG. 13 is a first side view thereof;

FIG. 14 is a second side view thereof;

FIG. 15 is a top view thereof; and,

FIG. 16 is a bottom view thereof.

**1 Claim, 16 Drawing Sheets**  
**(8 of 16 Drawing Sheet(s) Filed in Color)**

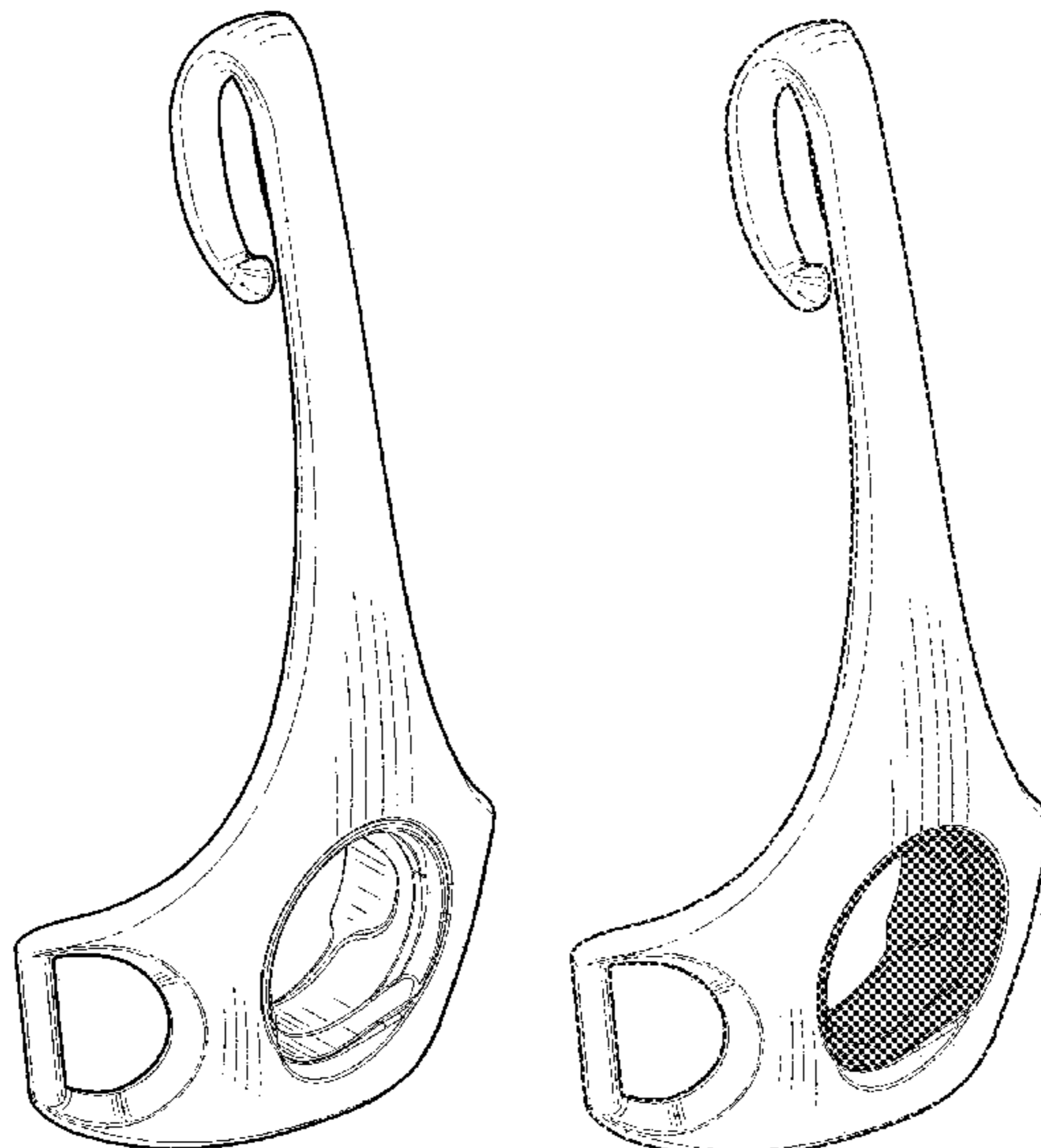

(58) **Field of Classification Search**

CPC ..... A61M 16/0683; A61M 16/0605; A61M 16/0622; A61M 16/06; A61M 16/0616; A61M 16/0661; A61M 16/0633; A61M 16/0644; A61M 16/0816; A61M 16/08; A61M 16/0666; A61M 2210/0618

See application file for complete search history.

(56) **References Cited**

U.S. PATENT DOCUMENTS

6,691,707	B1	2/2004	Gunaratnam et al.
D539,901	S	4/2007	McAuliffe et al.
7,290,546	B2	11/2007	Sprinkle et al.
D556,899	S	12/2007	Veliss et al.
D579,105	S	10/2008	Jones et al.
D597,202	S	7/2009	Reid et al.
7,793,987	B1	9/2010	Busch et al.
D637,283	S	5/2011	Selvarajan et al.
D651,304	S	12/2011	Edwards et al.
D656,231	S	3/2012	Henry et al.
D679,376	S	4/2013	Von Hollen et al.
D679,377	S	4/2013	Von Hollen et al.
D679,378	S	4/2013	Von Hollen et al.
D683,447	S *	5/2013	Olsen ..... D24/110.1
D692,554	S	10/2013	Siew et al.
D693,459	S *	11/2013	Prentice ..... D24/110.1
D695,887	S *	12/2013	Ozolins ..... D24/110.4
D696,767	S	12/2013	Scheiner et al.
D697,203	S	1/2014	Clarke et al.
D706,413	S	6/2014	Veliss et al.
D717,945	S	11/2014	Neff et al.
8,950,404	B2	2/2015	Formica et al.
D740,934	S	10/2015	Formica et al.
D748,242	S	1/2016	Campbell et al.
D751,188	S *	3/2016	Skipper ..... D24/110.4
D753,813	S *	4/2016	Ozolins ..... D24/110.1
D754,328	S	4/2016	Bowsher et al.
2002/0023649	A1	2/2002	Gunaratnam
2002/0026934	A1	3/2002	Lithgow
2003/0196659	A1	10/2003	Gradon et al.
2004/0083534	A1	5/2004	Ruiz
2004/0112377	A1	6/2004	Amarasinghe
2007/0175480	A1	8/2007	Gradon et al.
2008/0192459	A1	8/2008	Kwok et al.
2009/0194111	A1	8/2009	Fu et al.
2010/0000538	A1	1/2010	Edwards et al.
2010/0031963	A1	2/2010	Lee et al.
2010/0059058	A1	3/2010	Kuo
2011/0197341	A1	8/2011	Formica et al.
2012/0204881	A1	8/2012	Davidson et al.
2012/0234326	A1	9/2012	Mazzone et al.

2012/0305001	A1 *	12/2012	Tatkov ..... A61M 16/06 128/205.25
2013/0152937	A1	6/2013	Jablonski et al.
2013/0152938	A1	6/2013	Jablonski et al.
2013/0239972	A1	9/2013	McAuley et al.
2014/0090649	A1	4/2014	Groll et al.
2014/0096774	A1	4/2014	Olsen et al.
2014/0174446	A1 *	6/2014	Prentice ..... A61M 16/06 128/205.25
2014/0261427	A1 *	9/2014	Foote ..... A61M 16/0069 128/204.23
2014/0305433	A1	10/2014	Rothermel
2014/0326246	A1	11/2014	Chodkowski et al.
2015/0000671	A1 *	1/2015	Frerichs ..... A61M 16/0683 128/206.21
2015/0151069	A1	6/2015	Zeijlstra et al.
2015/0174354	A1 *	6/2015	Matula, Jr. .... A61M 16/06 128/202.27
2015/0174355	A1 *	6/2015	Willard ..... A61M 16/0605 128/202.13
2015/0202397	A1 *	7/2015	Pastoor ..... A61M 16/0683 128/205.25
2015/0209540	A1 *	7/2015	Hendriks ..... A61M 16/0683 128/204.21
2015/0306320	A1	10/2015	Markus
2015/0328422	A1 *	11/2015	Chodkowski ..... A61M 16/06 128/206.21
2015/0367092	A1	12/2015	Goff et al.
2016/0008558	A1 *	1/2016	Huddart ..... A61M 16/06 128/205.25
2016/0067442	A1 *	3/2016	Salmon ..... A61M 16/0683 128/205.25
2016/0082218	A1	3/2016	Lau et al.
2016/0121067	A1	5/2016	VanMiddendorp et al.

OTHER PUBLICATIONS

New—Eson 2 Fisher & Paykel Nasal Mask. CPAP Victoria: Snoring & Sleep Apnoea Solutions. [cpapvictoria.com.au](http://cpapvictoria.com.au). Date accessed: May 21, 2016. <<http://cpapvictoria.com.au/new-eson-2-fisher-paykel-nasal-mask.html>>.\*

Fisher & Paykel Eson 2 Nasal Mask. CPAP Direct. [cpapdirect.com.au](http://cpapdirect.com.au). Date accessed: May 21, 2016. <<https://cpapdirect.com.au/wp-content/uploads/2015/12/Eson2-Exploded-Image.jpg>>.\*

Office Action for U.S. Appl. No. 29/540,662 dated May 19, 2016.

Office Action for U.S. Appl. No. 29/540,681 dated May 19, 2016.

Office Action for U.S. Appl. No. 29/540,680 dated Jun. 2, 2016.

Swivel for Fisher Paykel Eson2 Nasal Mask #400FPH241. CPAP Australia. [www.cpapaustralia.com.au](http://www.cpapaustralia.com.au). Date accessed: May 21, 2016. <<https://www.cpapaustralia.com.au/shopping/swivel-for-fisher-paykel-eson2-nasal-mask-400fph241.html>>.

\* cited by examiner

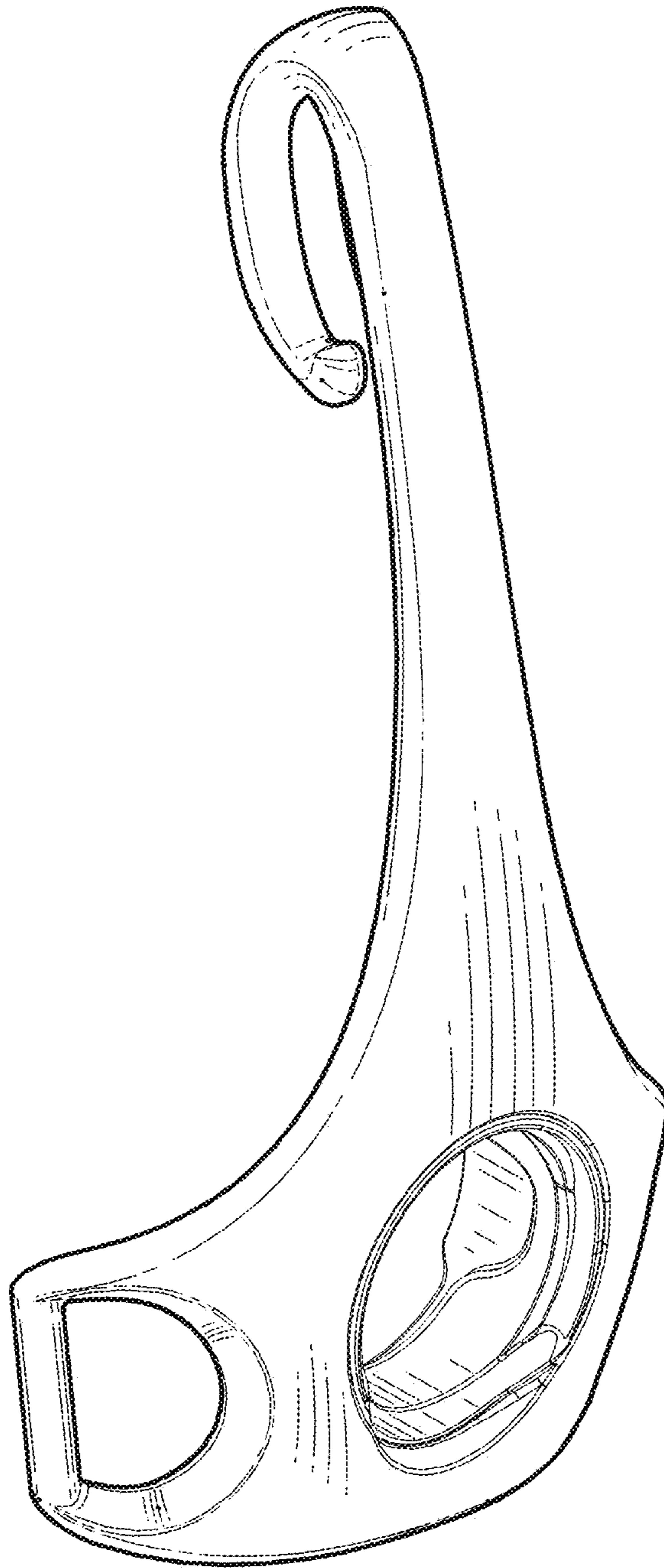

FIG. 1



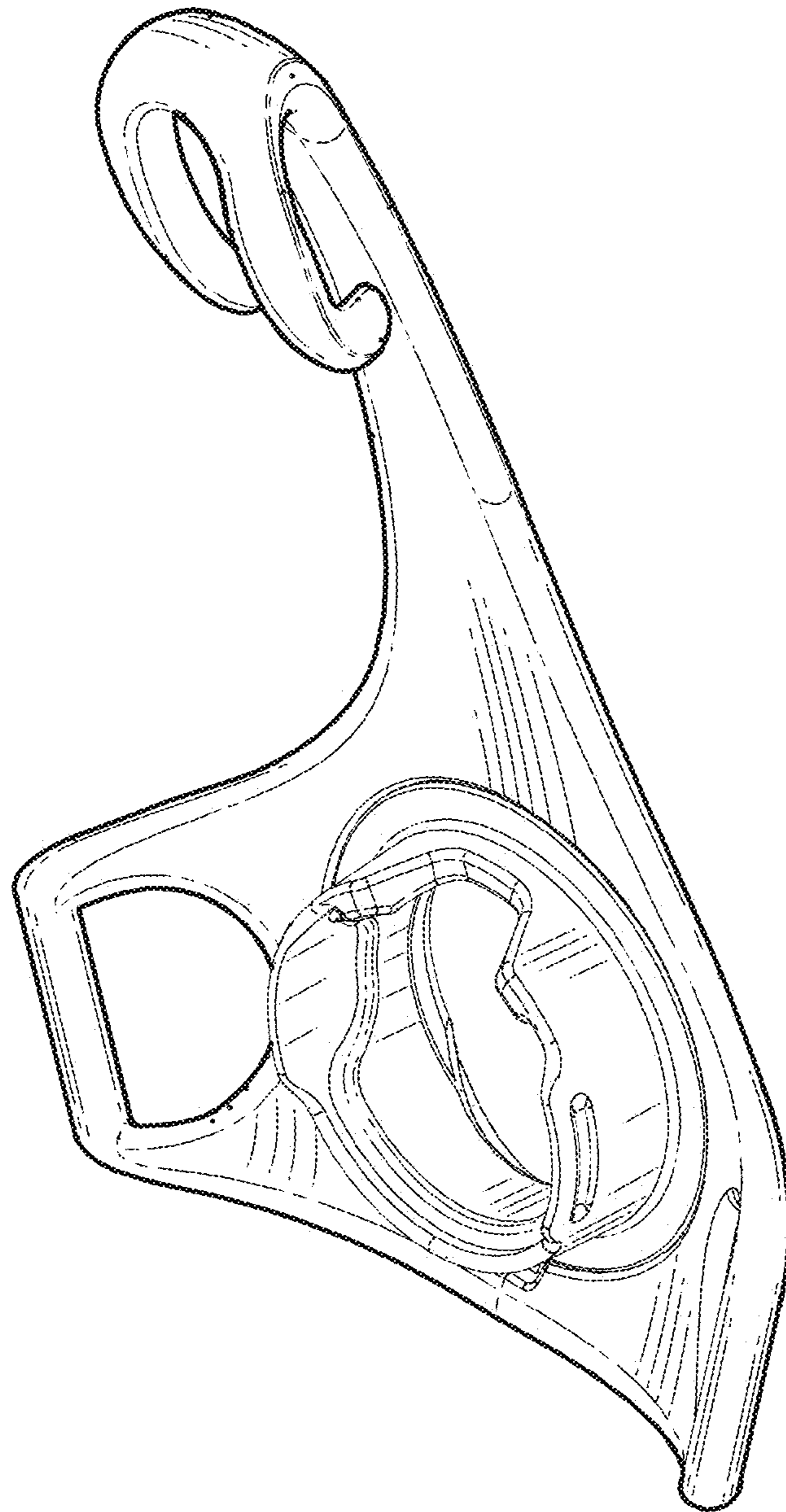

FIG. 2

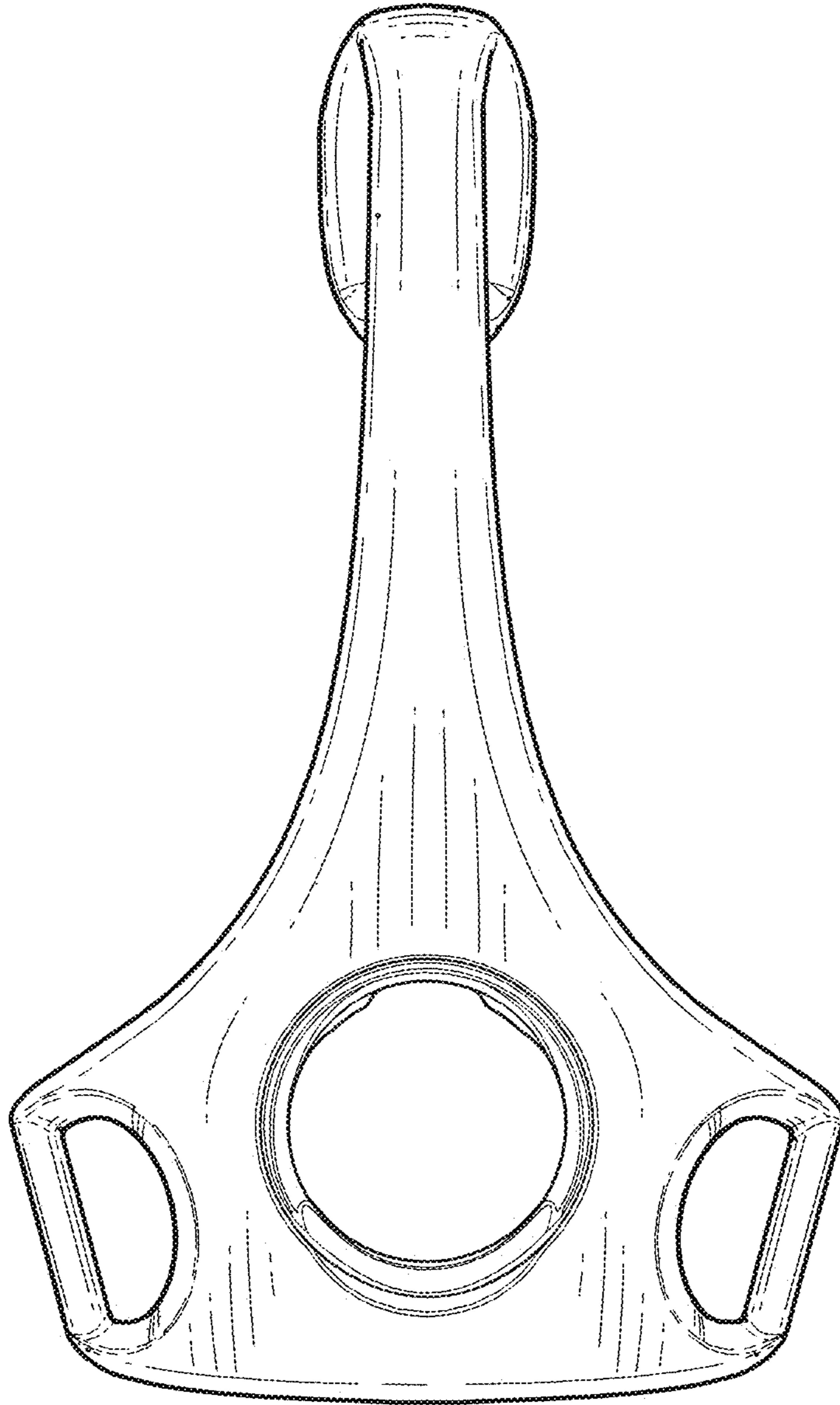

FIG. 3

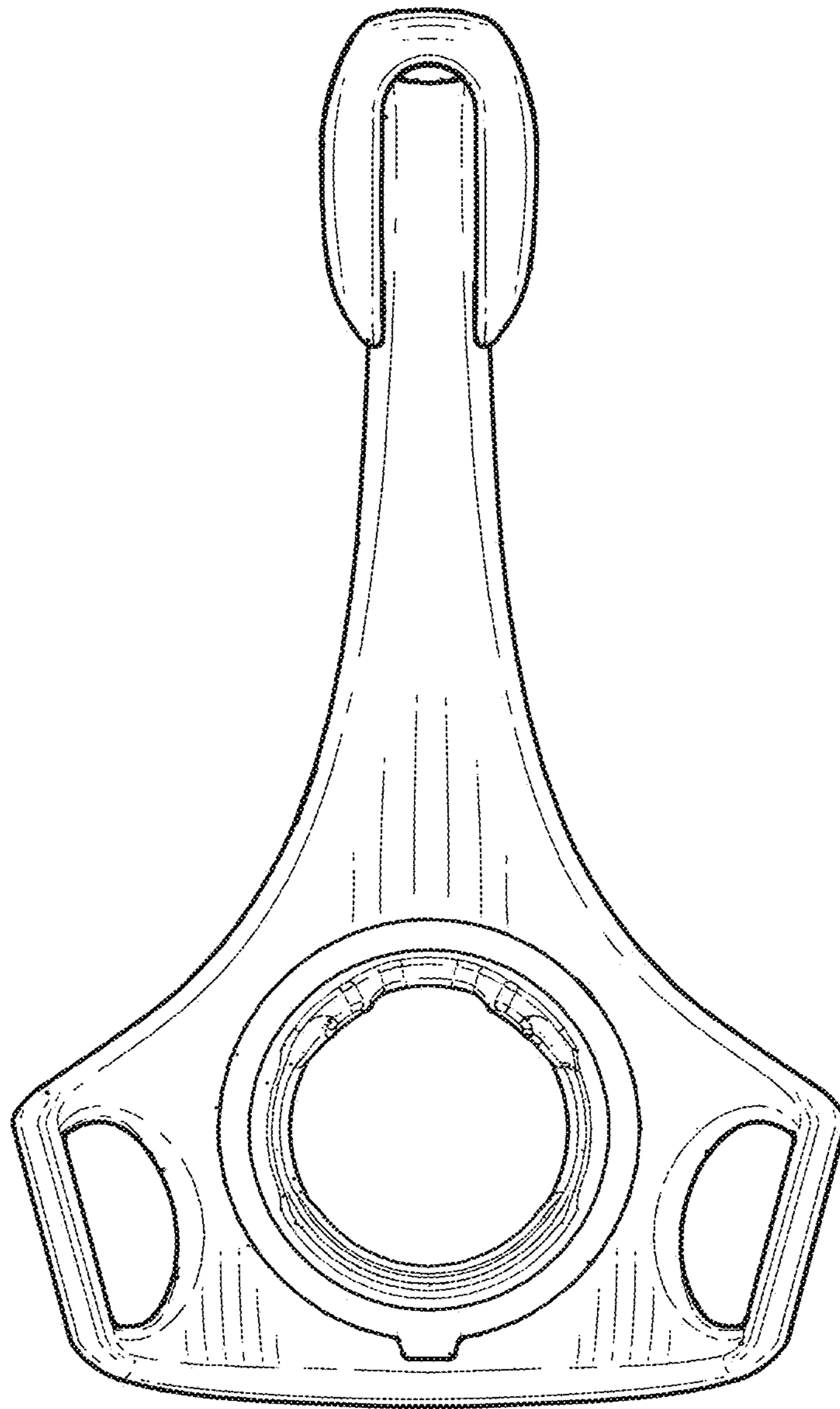

FIG. 4

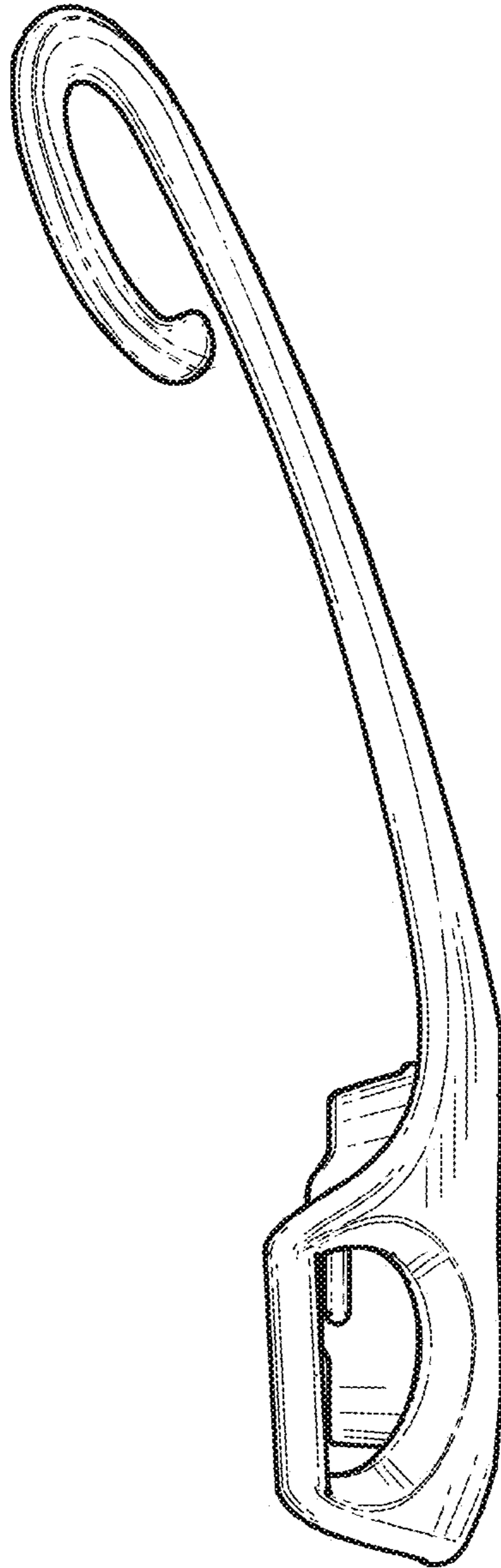

FIG. 5

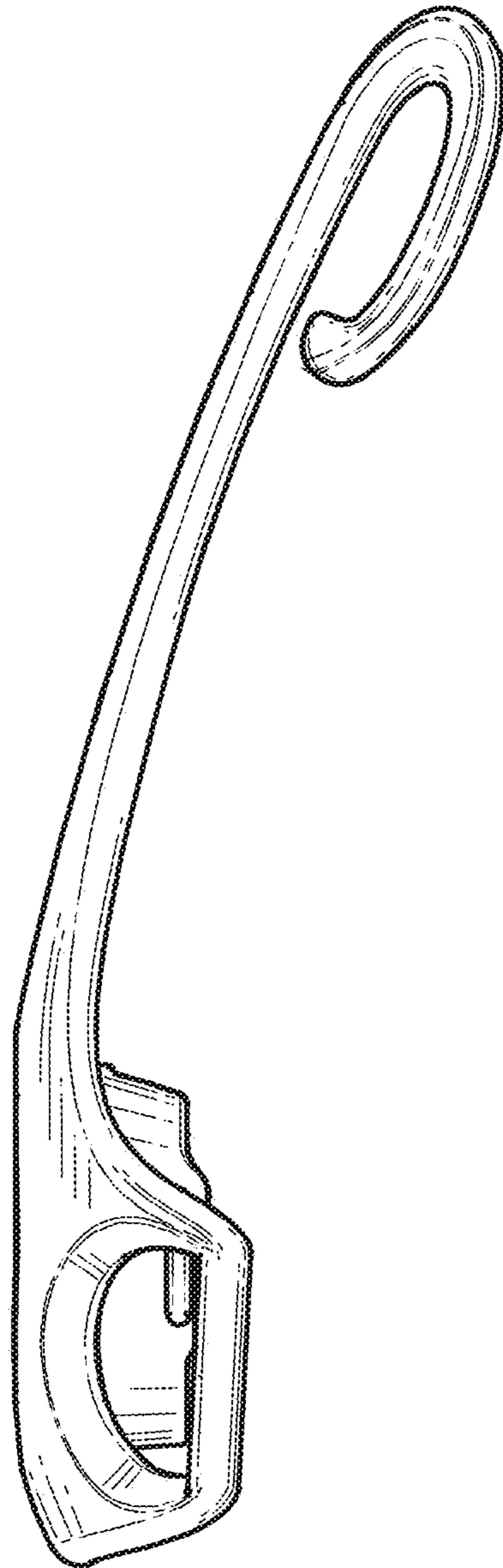

FIG. 6



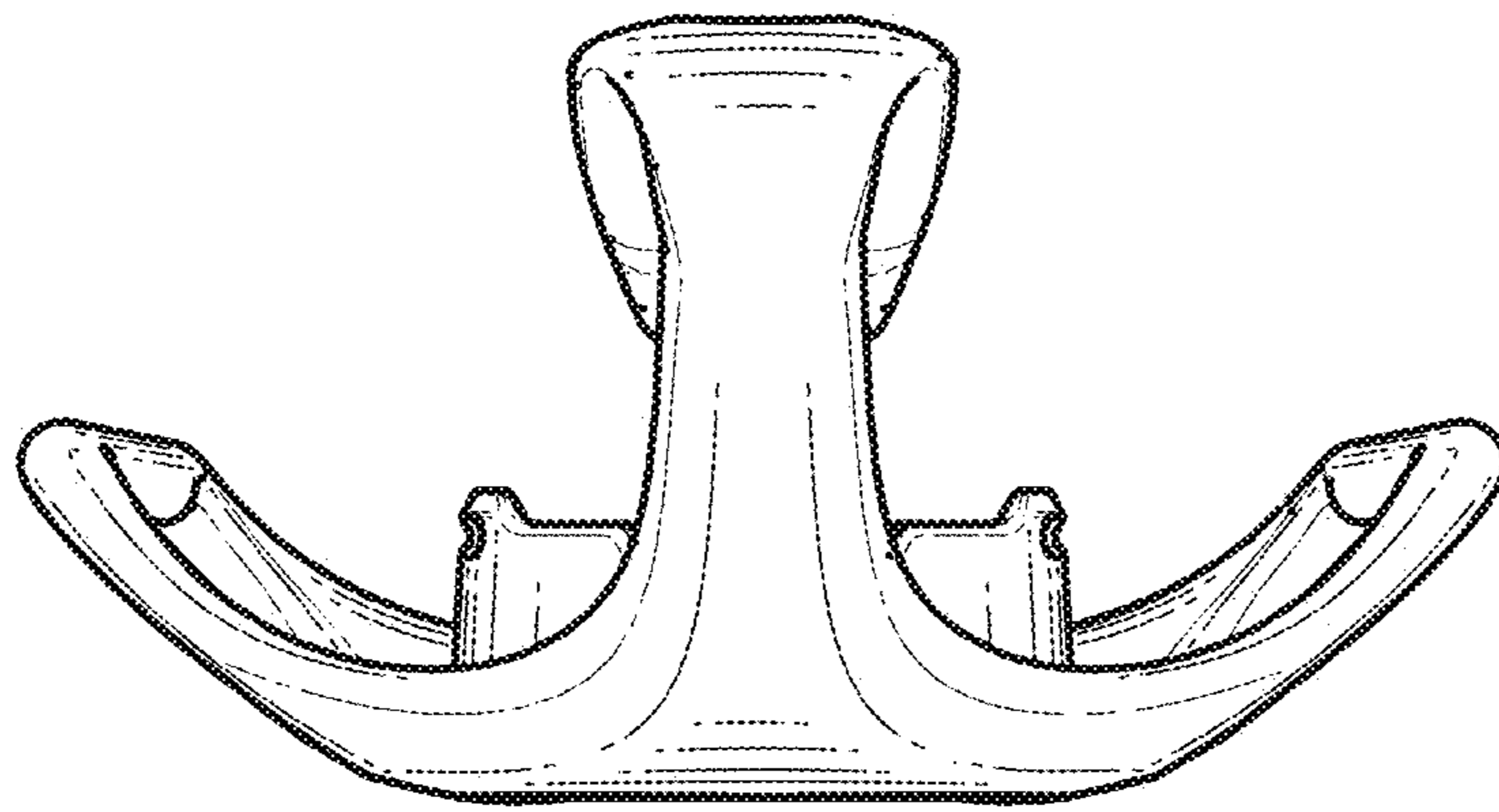

FIG. 7

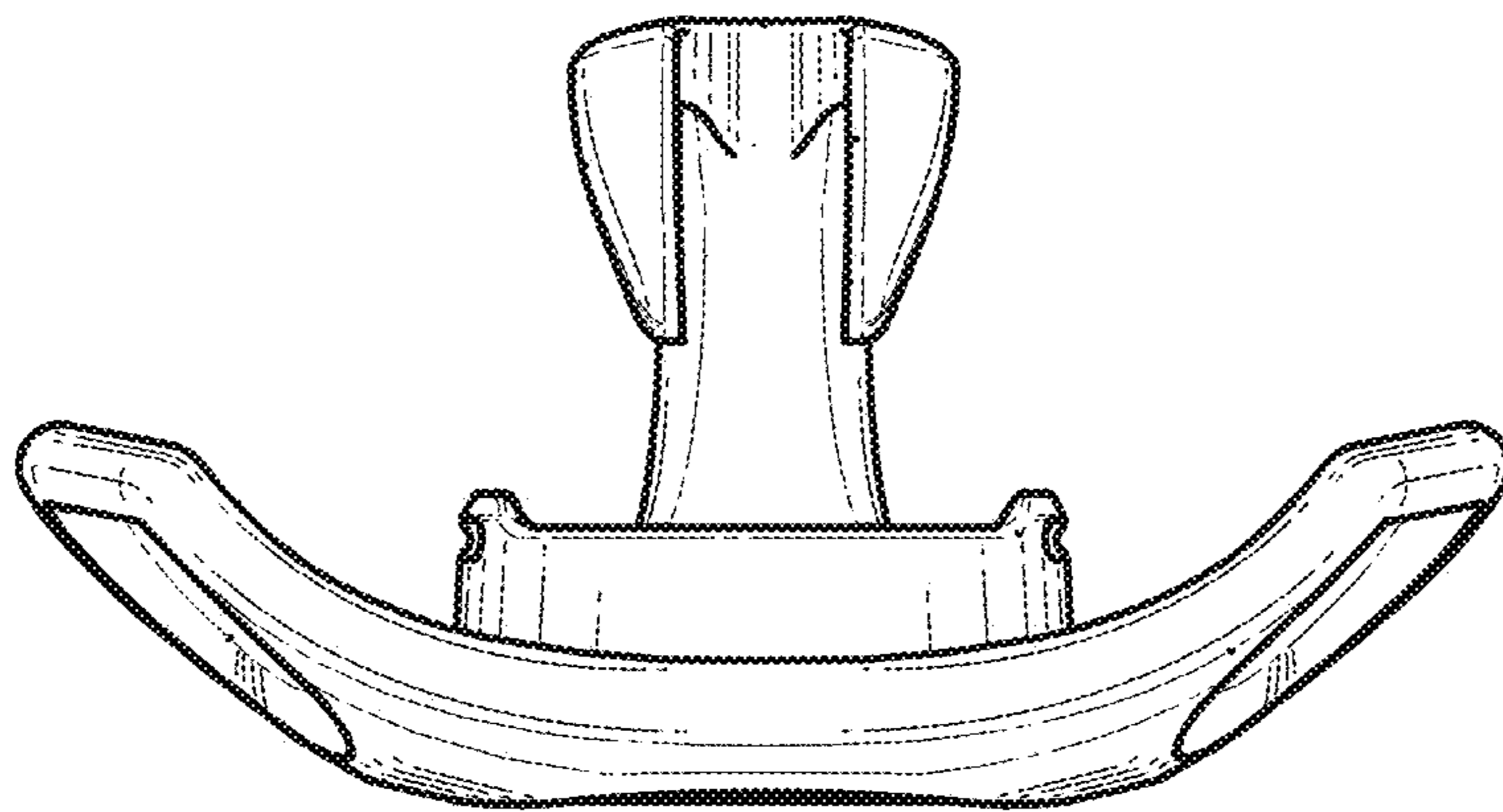

FIG. 8

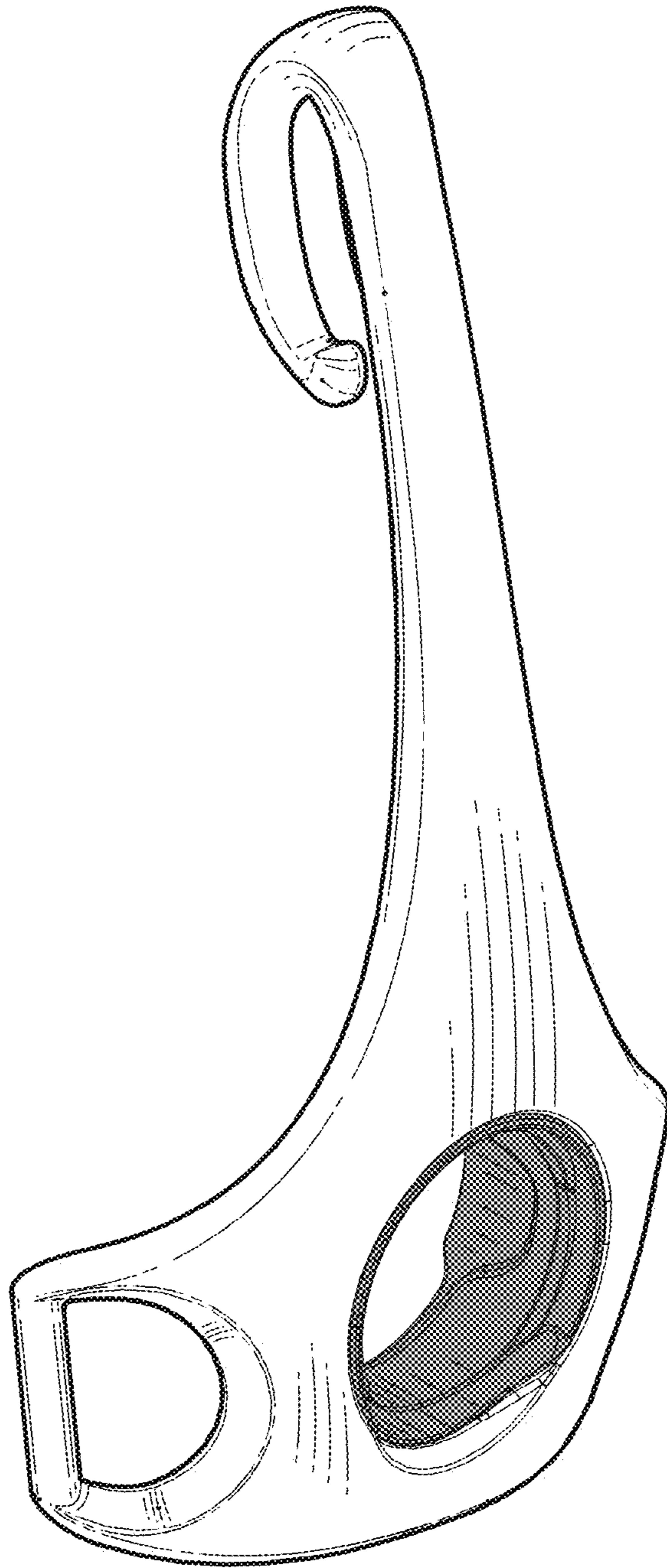

FIG. 9

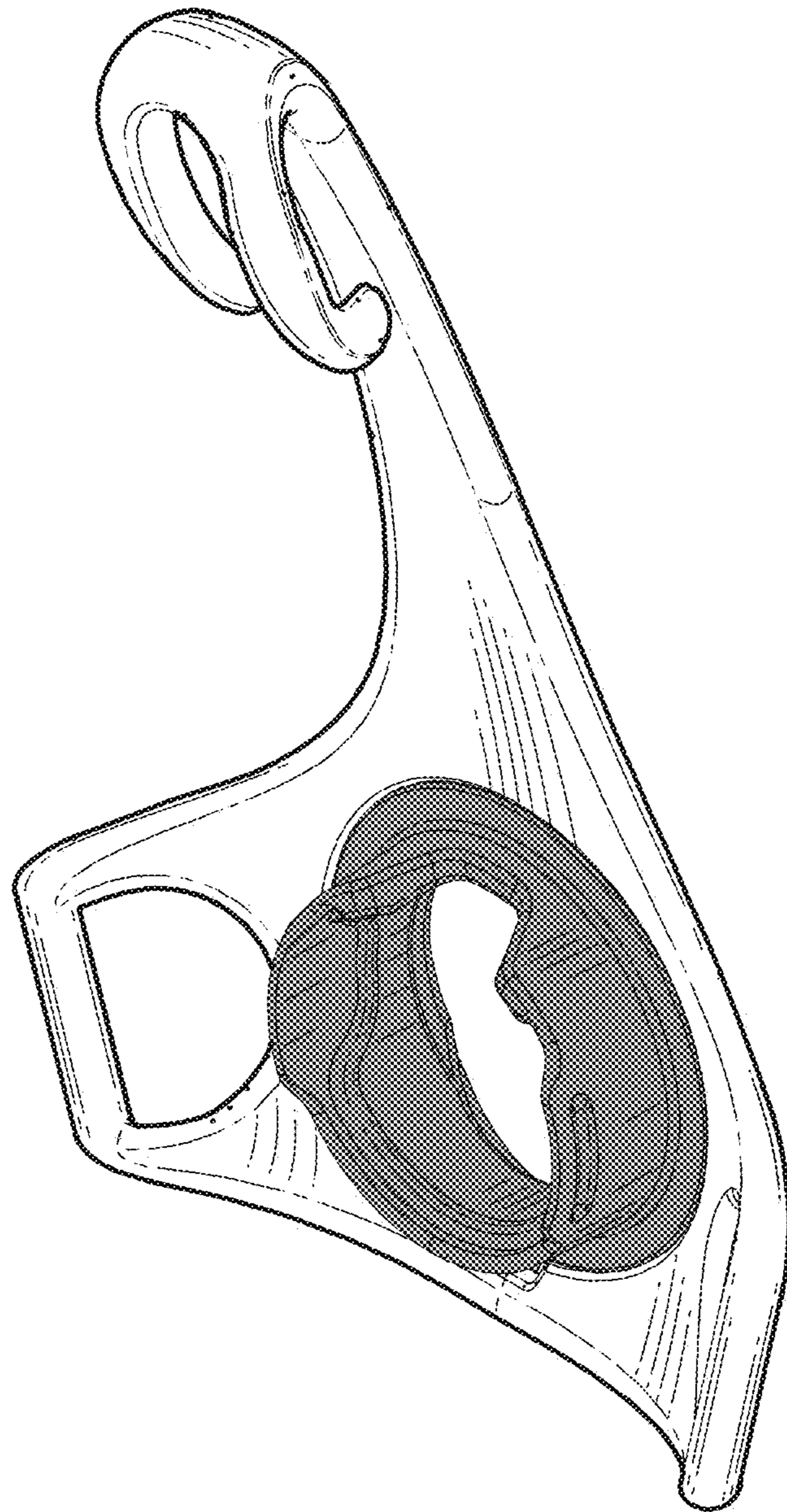

FIG. 10



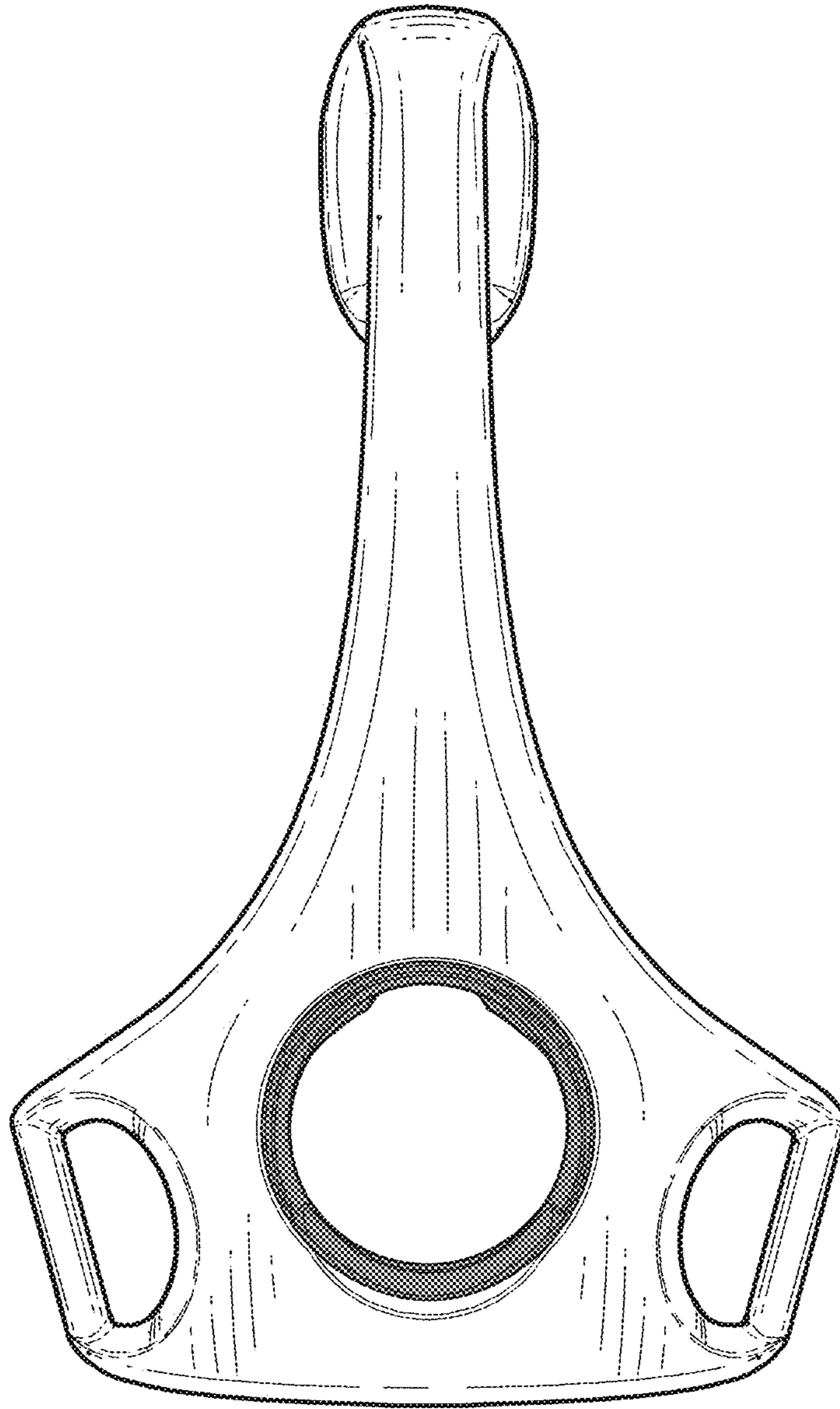

FIG. 11

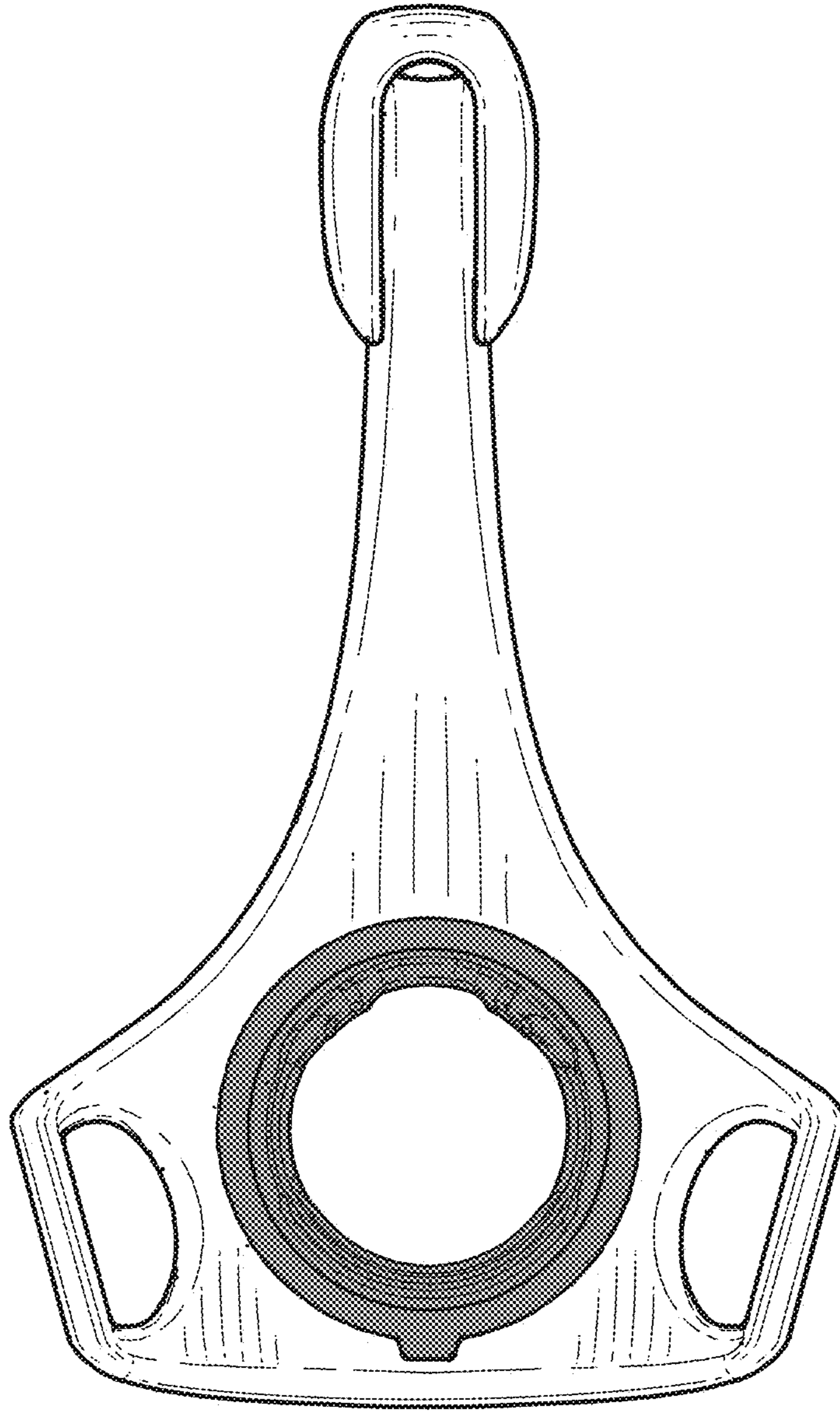

FIG. 12

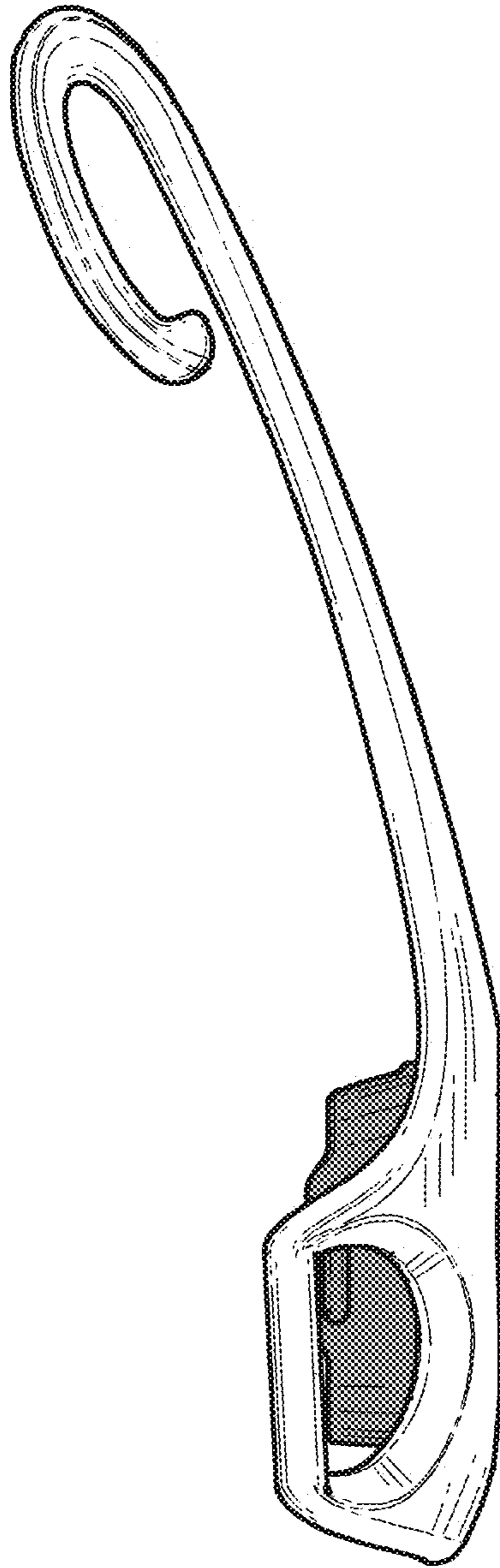

FIG. 13

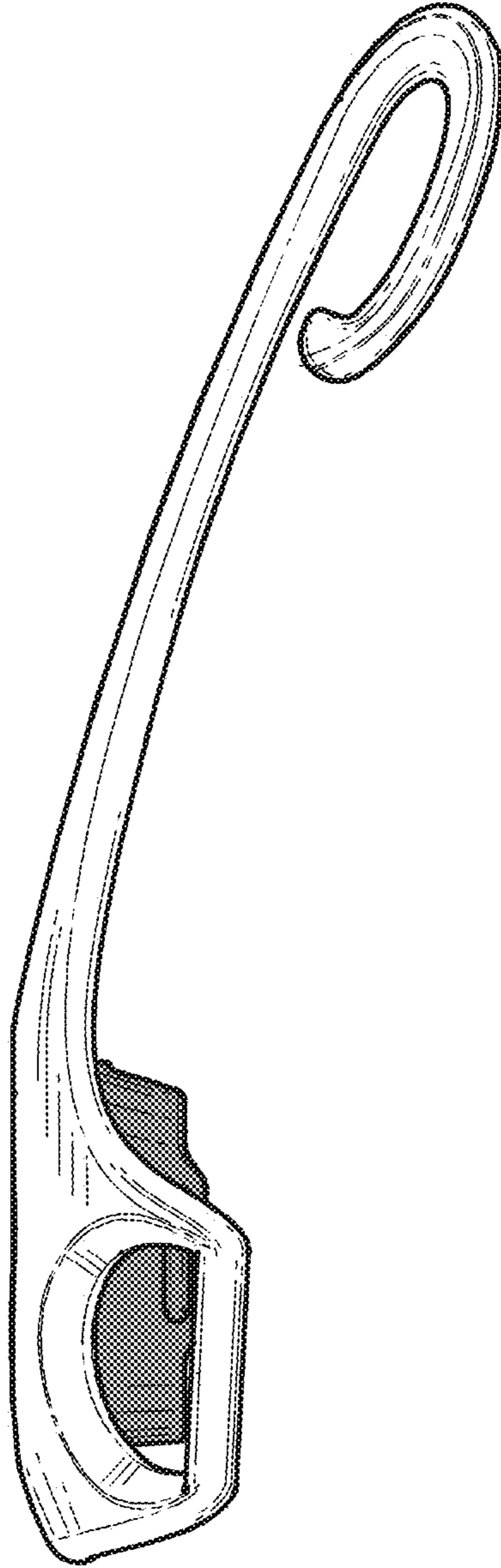

FIG. 14



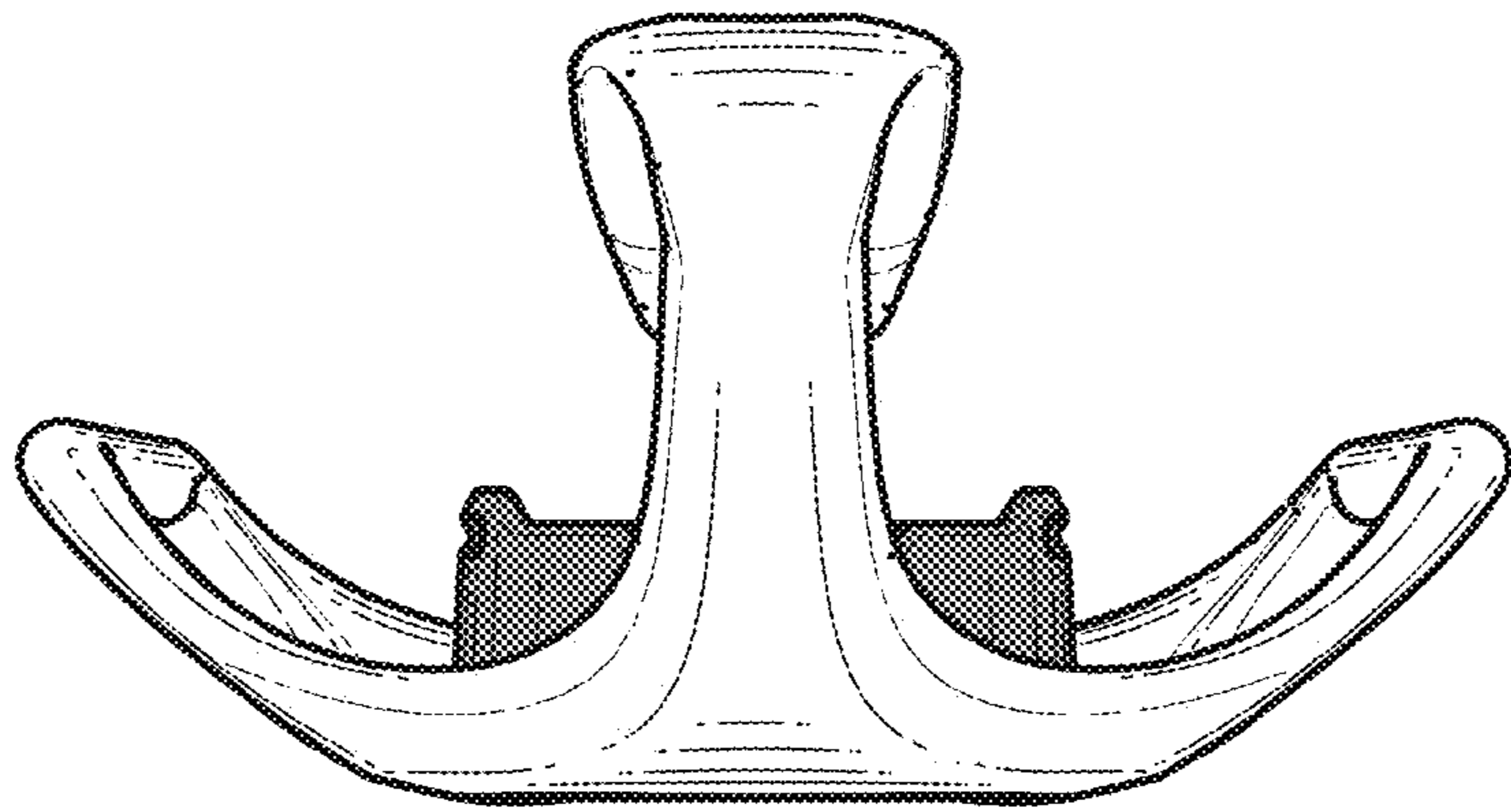

FIG. 15

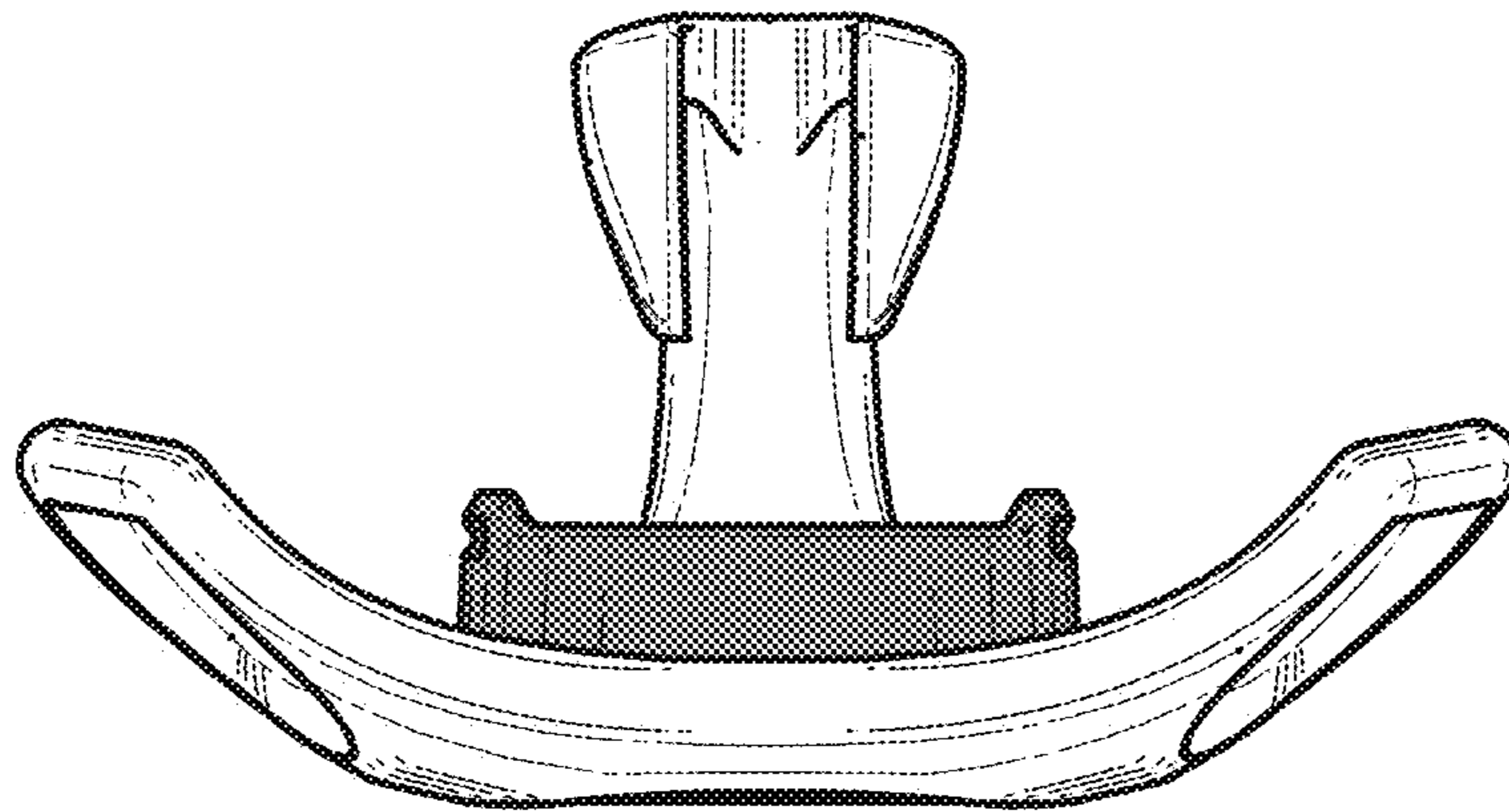

FIG. 16