



US00D784501S

(12) **United States Design Patent**
Pham et al.

(10) **Patent No.:** **US D784,501 S**
(45) **Date of Patent:** **** Apr. 18, 2017**

(54) **SHOWER BASE**

(71) Applicant: **Fleurco Products Inc.**, Ville
Saint-Laurent (CA)

(72) Inventors: **Chi Hai Pham**, Brossard (CA); **Robert
Schachter**, Montreal (CA); **Chifen
Cheng**, Montreal (CA)

(**) Term: **15 Years**

(21) Appl. No.: **29/537,422**

(22) Filed: **Aug. 26, 2015**

(30) **Foreign Application Priority Data**

Mar. 10, 2015 (CA) 161357

(51) **LOC (10) Cl.** **23-02**

(52) **U.S. Cl.**
USPC **D23/304**

(58) **Field of Classification Search**
USPC D23/275, 277, 283, 303-304
CPC A47K 3/022; A47K 3/282; A47K 3/40;
A47K 3/28

See application file for complete search history.

(56) **References Cited**

U.S. PATENT DOCUMENTS

D332,136 S *	12/1992	Salach	D23/283
D648,839 S *	11/2011	Garrels	D23/304
D678,488 S *	3/2013	Schachter	D23/304
D681,178 S *	4/2013	Schachter	D23/304
D692,992 S *	11/2013	Whitinger	A47K 3/405 D23/304

* cited by examiner

Primary Examiner — Robert Delehanty

(74) *Attorney, Agent, or Firm* — Eric L. Lane; Green
Patent Law

(57) **CLAIM**

The ornamental design of a shower base, as shown and
described.

DESCRIPTION

FIG. 1 is a front perspective view showing the design;
FIG. 2 is a rear perspective view thereof;
FIG. 3 is a top view thereof;
FIG. 4 is a side view thereof;
FIG. 5 is a rear view thereof; and,
FIG. 6 is a front view thereof.

1 Claim, 5 Drawing Sheets

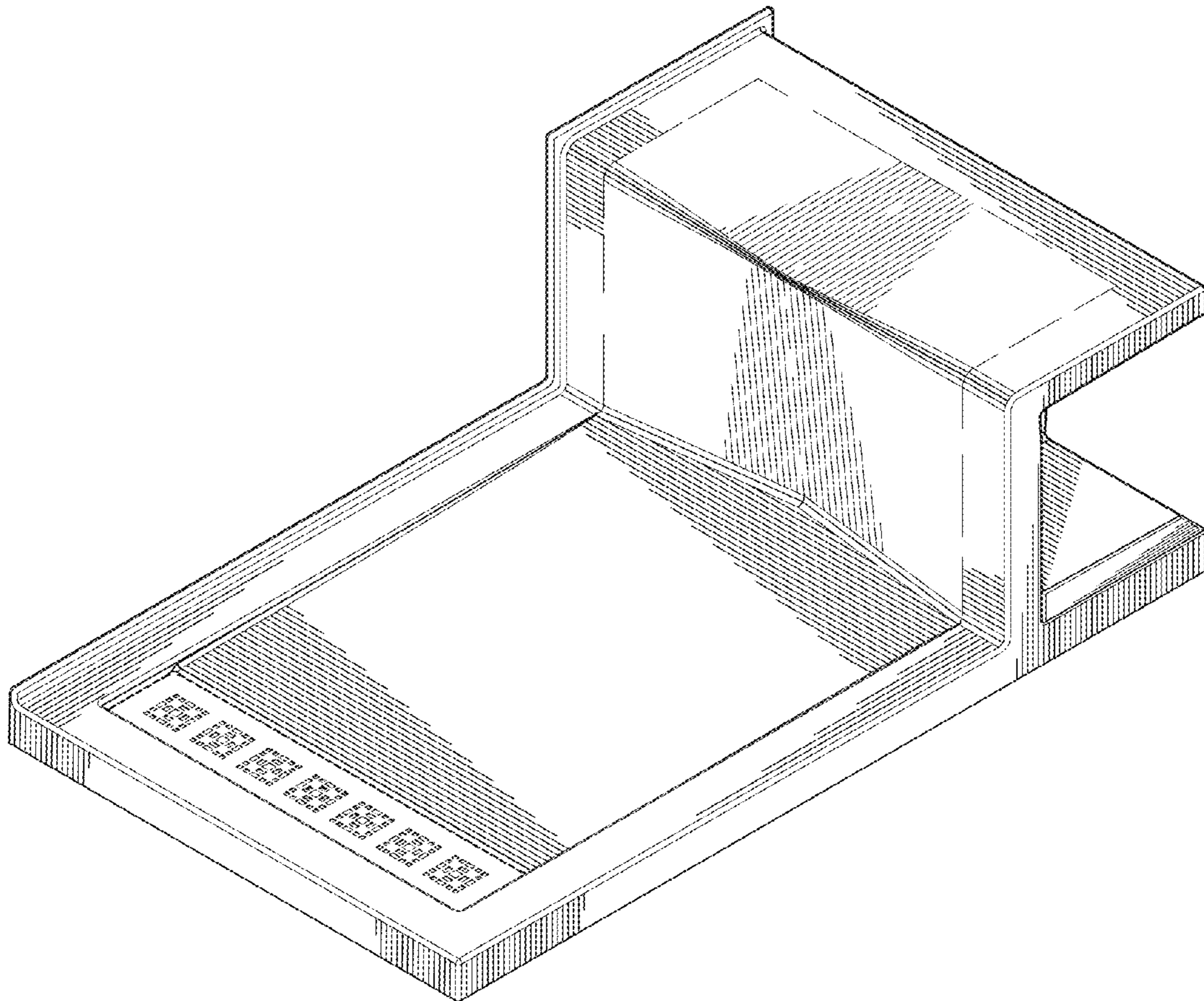

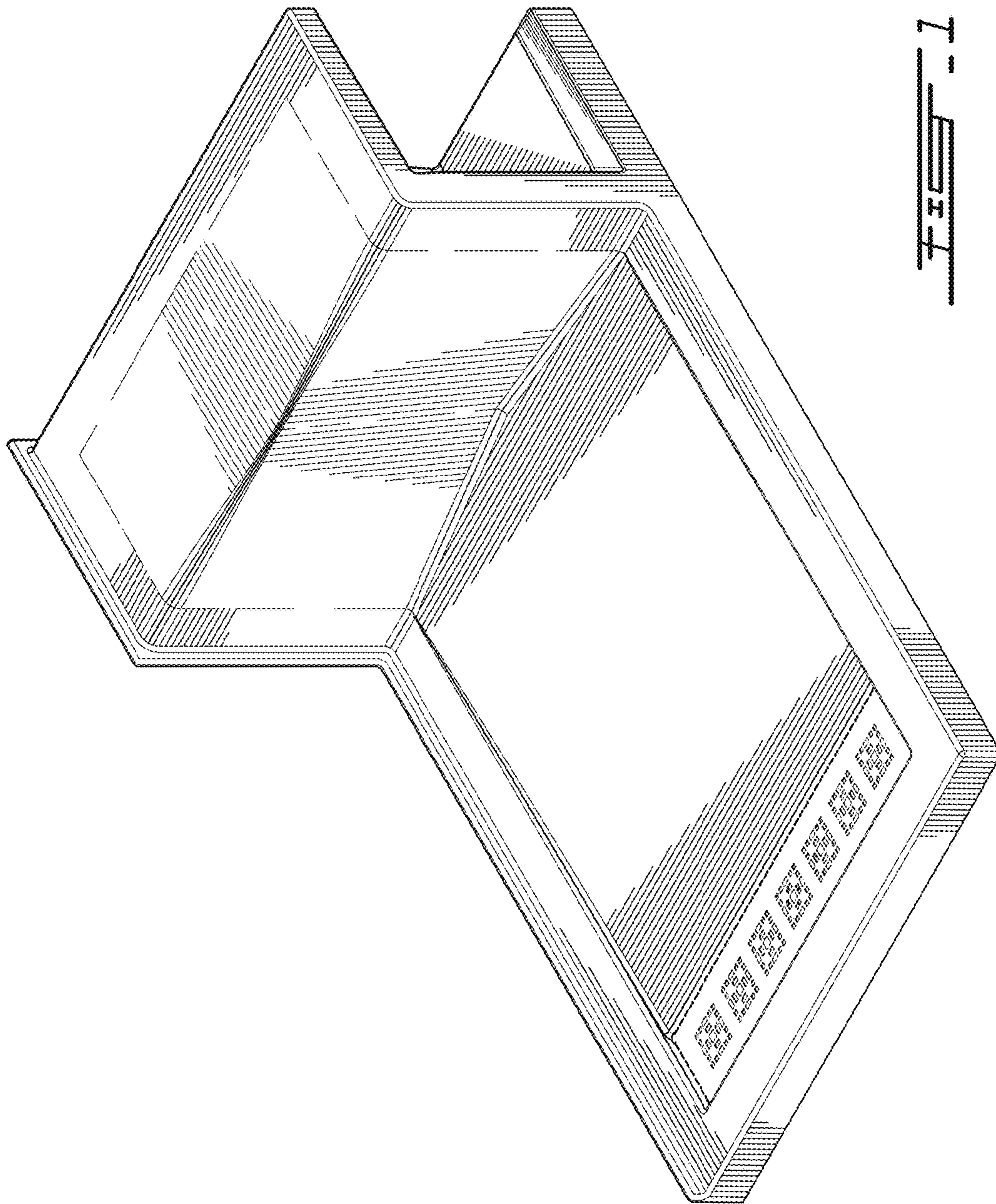

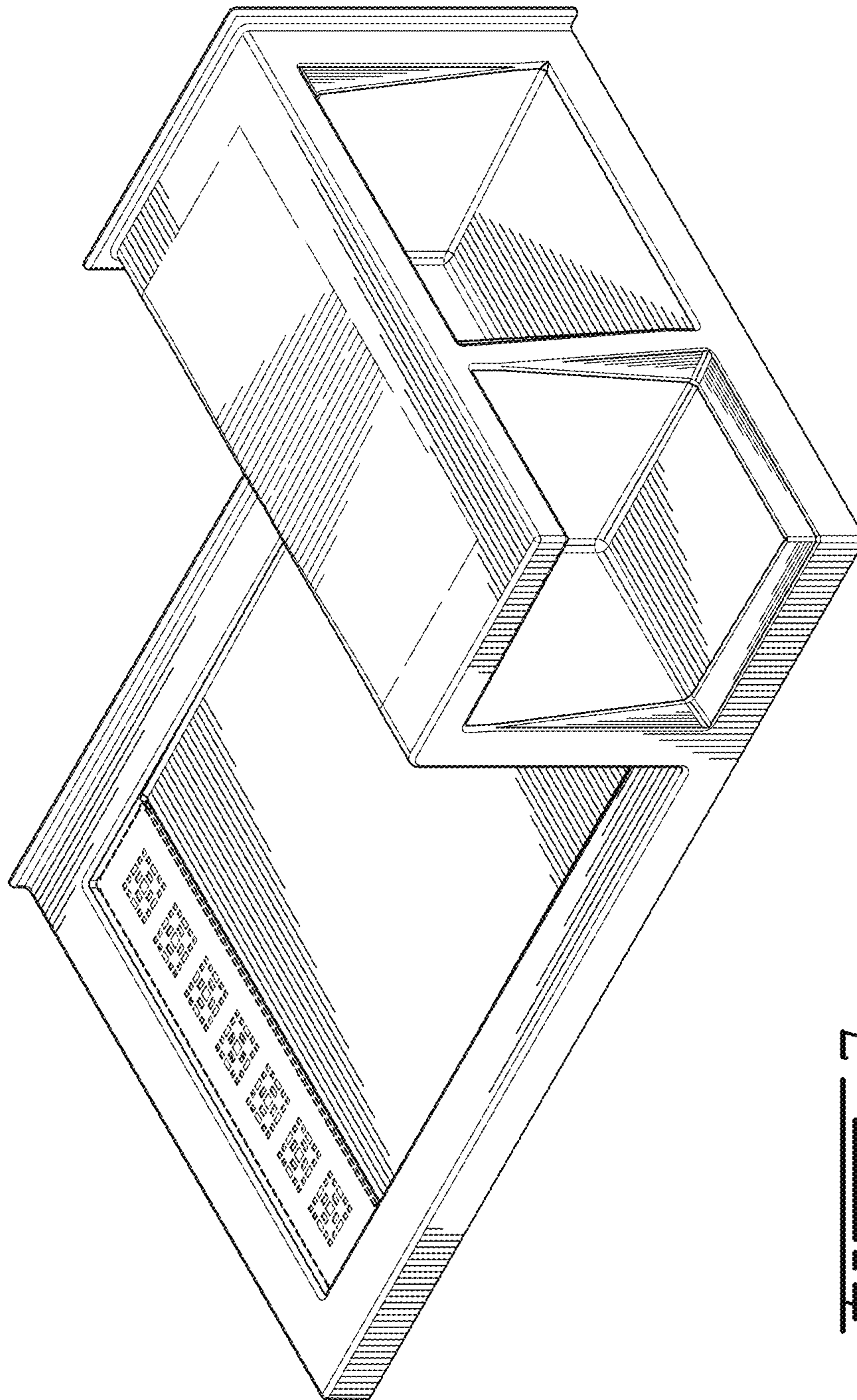

FIG. 2

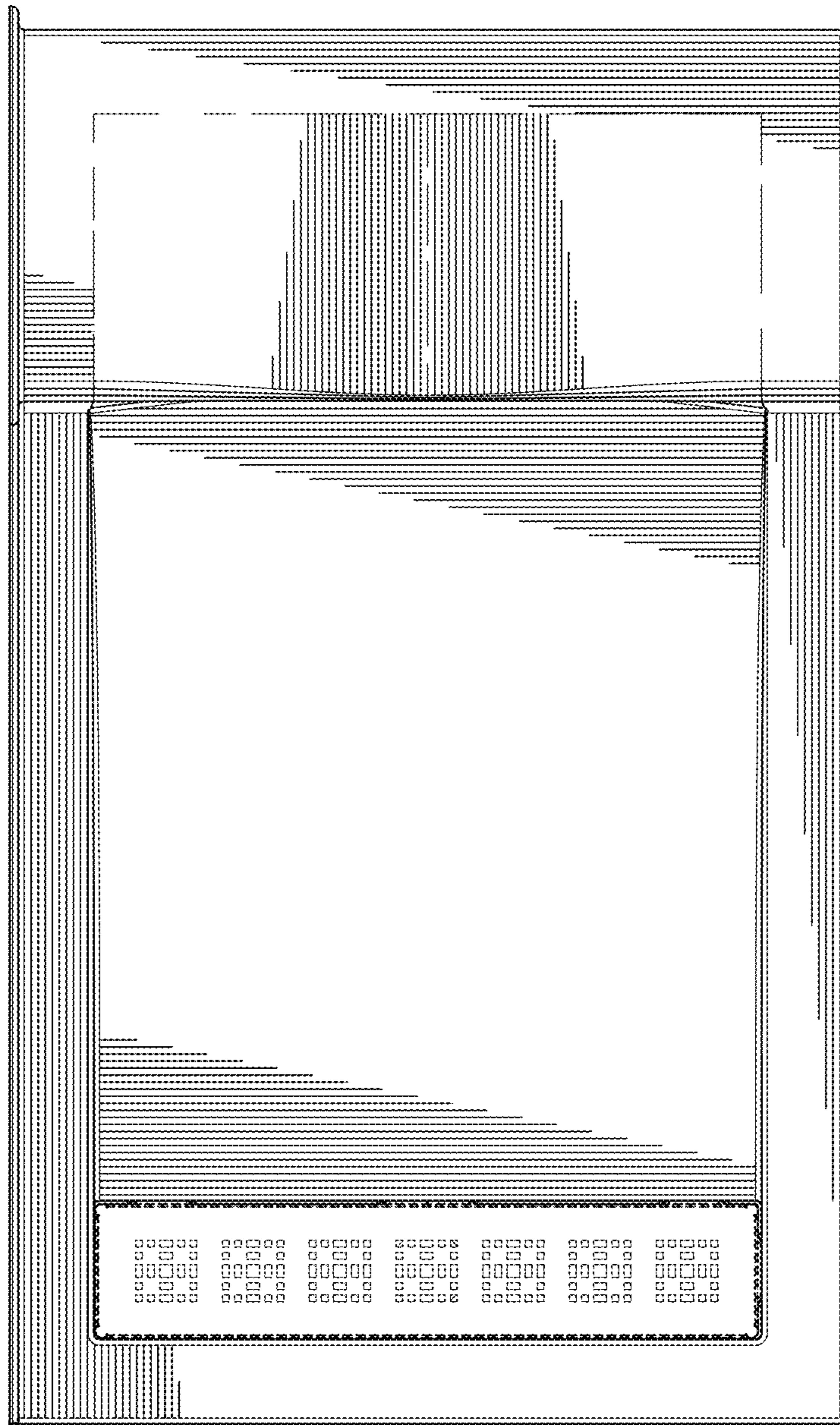

FIG. 3

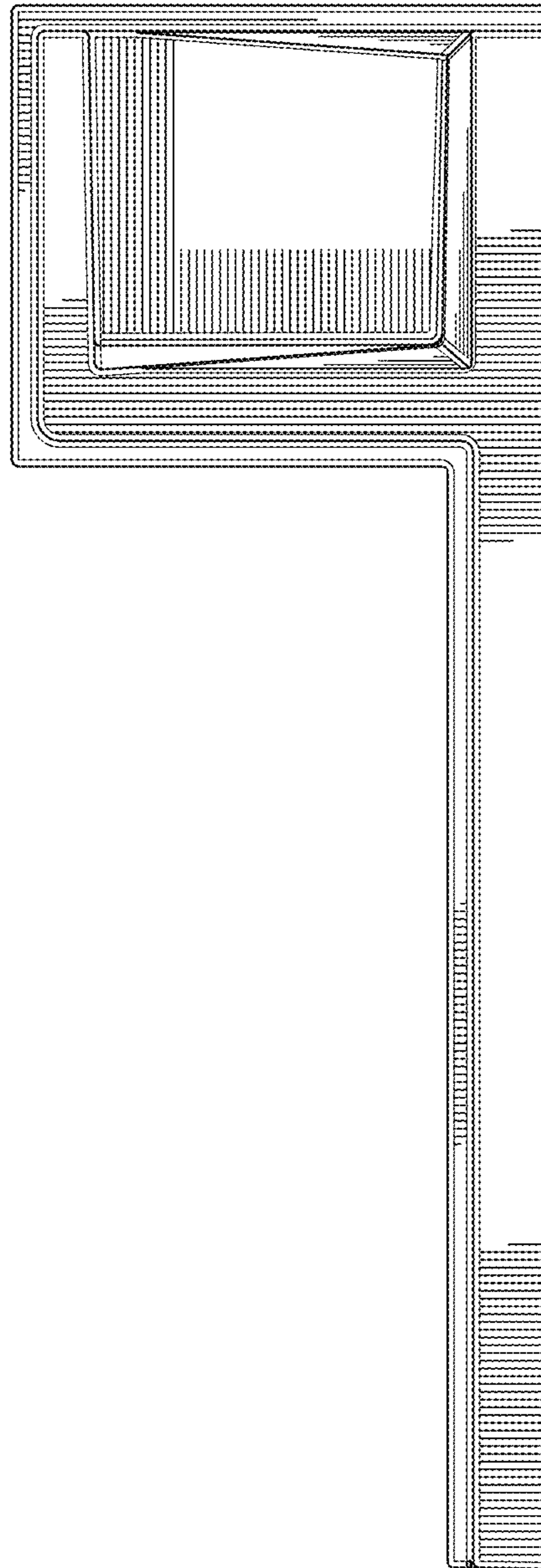

FIG. 4

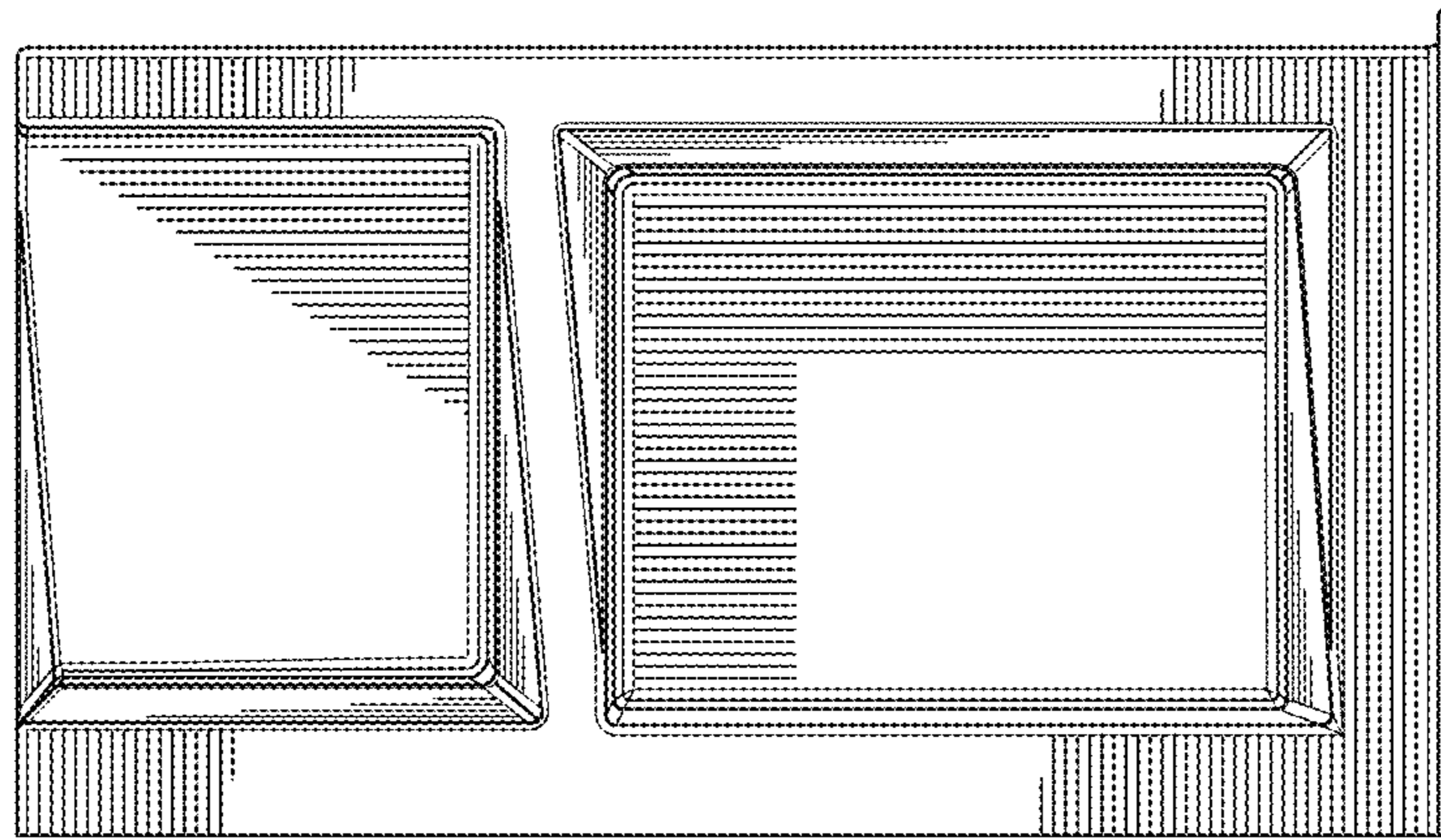

FIG. 5

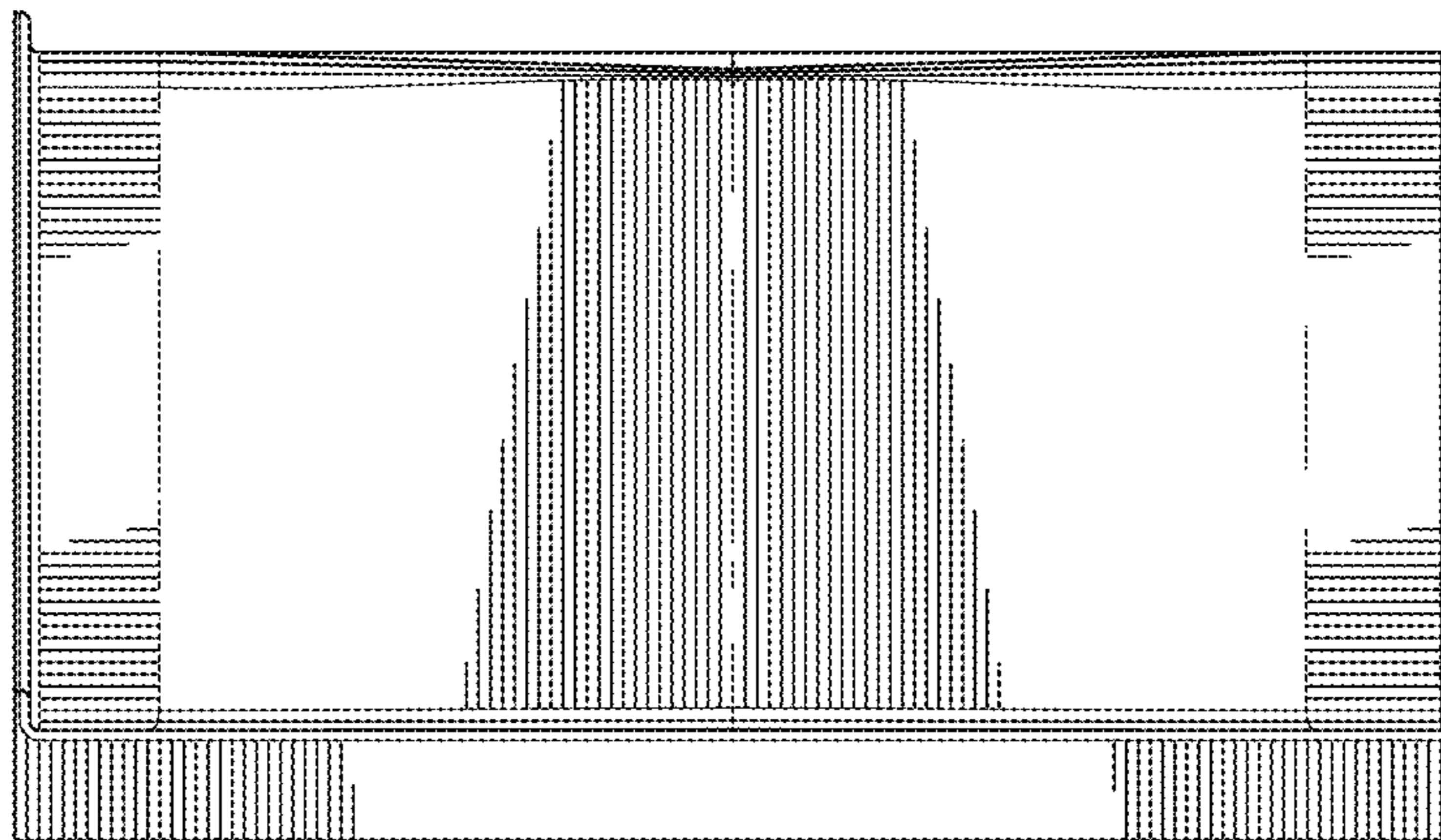

FIG. 6