



US00D784274S

(12) **United States Design Patent**
Gage et al.

(10) **Patent No.:** **US D784,274 S**

(45) **Date of Patent:** **** *Apr. 18, 2017**

(54) **KEYPAD**

(71) Applicant: **Lutron Electronics Co., Inc.**,
Coopersburg, PA (US)

(72) Inventors: **Alexander Wade Gage**, Havertown, PA
(US); **Elliot G. Jacoby**, Glenside, PA
(US); **Jason C. Killo**, Emmaus, PA
(US); **Brad Michael Kreschollek**,
Bethlehem, PA (US); **Noel Mayo**,
Philadelphia, PA (US); **Daniel Curtis**
Raneri, Bethlehem, PA (US)

(73) Assignee: **Lutron Electronics Co., Inc.**,
Coopersburg, PA (US)

(*) Notice: This patent is subject to a terminal dis-
claimer.

(**) Term: **15 Years**

(21) Appl. No.: **29/536,771**

(22) Filed: **Aug. 19, 2015**

(51) **LOC (10) Cl.** **13-03**

(52) **U.S. Cl.**
USPC **D13/171**

(58) **Field of Classification Search**
USPC D13/162, 164, 171, 174
CPC G08C 17/02; H05B 33/0845; H05B 37/02;
H05B 37/0272; H05B 39/02; H05B
39/04; H05B 39/041; H05B 39/08; H05B
39/085

See application file for complete search history.

(56) **References Cited**

U.S. PATENT DOCUMENTS

D309,268 S	7/1990	Wada et al.
D310,340 S	9/1990	Wada et al.
D364,573 S	11/1995	Pearsall
D436,930 S	1/2001	Butler et al.
D453,742 S	2/2002	Butler et al.
D465,460 S	11/2002	Mayo et al.
D563,901 S	3/2008	Mayo et al.

D566,048 S	4/2008	Mace et al.
D566,658 S	4/2008	Mayo et al.
D568,828 S	5/2008	Mayo et al.
D570,299 S	6/2008	Jacoby et al.
D572,202 S	7/2008	Jacoby et al.
D572,208 S	7/2008	Mayo et al.
D572,667 S	7/2008	Mayo et al.
D573,956 S	7/2008	Hollner et al.
7,641,491 B2	1/2010	Altonen et al.
D624,881 S	10/2010	Altonen et al.
D624,882 S	10/2010	Altonen et al.
7,872,429 B2	1/2011	Steiner et al.

(Continued)

OTHER PUBLICATIONS

Lightolier, Specification Sheet for iGen DALI 4-Button Scene
Controller Model No. DA-WS₄SS-7, 2007, 2 pages.
Inncom, GS-700 Family Glass Series Switches Sell Sheet, Nov.
2008, 2 pages.
U.S. Appl. No. 29/502,399, filed Sep. 16, 2014. (Unpublished).
U.S. Appl. No. 29/515,919, filed Jan. 28, 2015. (Unpublished).
U.S. Appl. No. 29/515,921, filed Jan. 28, 2015. (Unpublished).
U.S. Appl. No. 29/447,481, filed Mar. 4, 2013. (Unpublished).
U.S. Appl. No. 29/447,485, filed Mar. 4, 2013. (Unpublished).

(Continued)

Primary Examiner — Selina Sikder
(74) *Attorney, Agent, or Firm* — Saidman DesignLaw
Group, LLC

(57) **CLAIM**

The ornamental design for a keypad, as shown and
described.

DESCRIPTION

FIG. 1 is a front perspective view of a keypad showing our
new design;
FIG. 2 is a front view thereof;
FIG. 3 is a left side view thereof;
FIG. 4 is a right side view thereof;
FIG. 5 is a top view thereof; and,
FIG. 6 is a bottom view thereof.

The dashed broken lines represent structure or features
which form no part of the claimed design; the broken lines
themselves form no part of the claimed design.

1 Claim, 4 Drawing Sheets

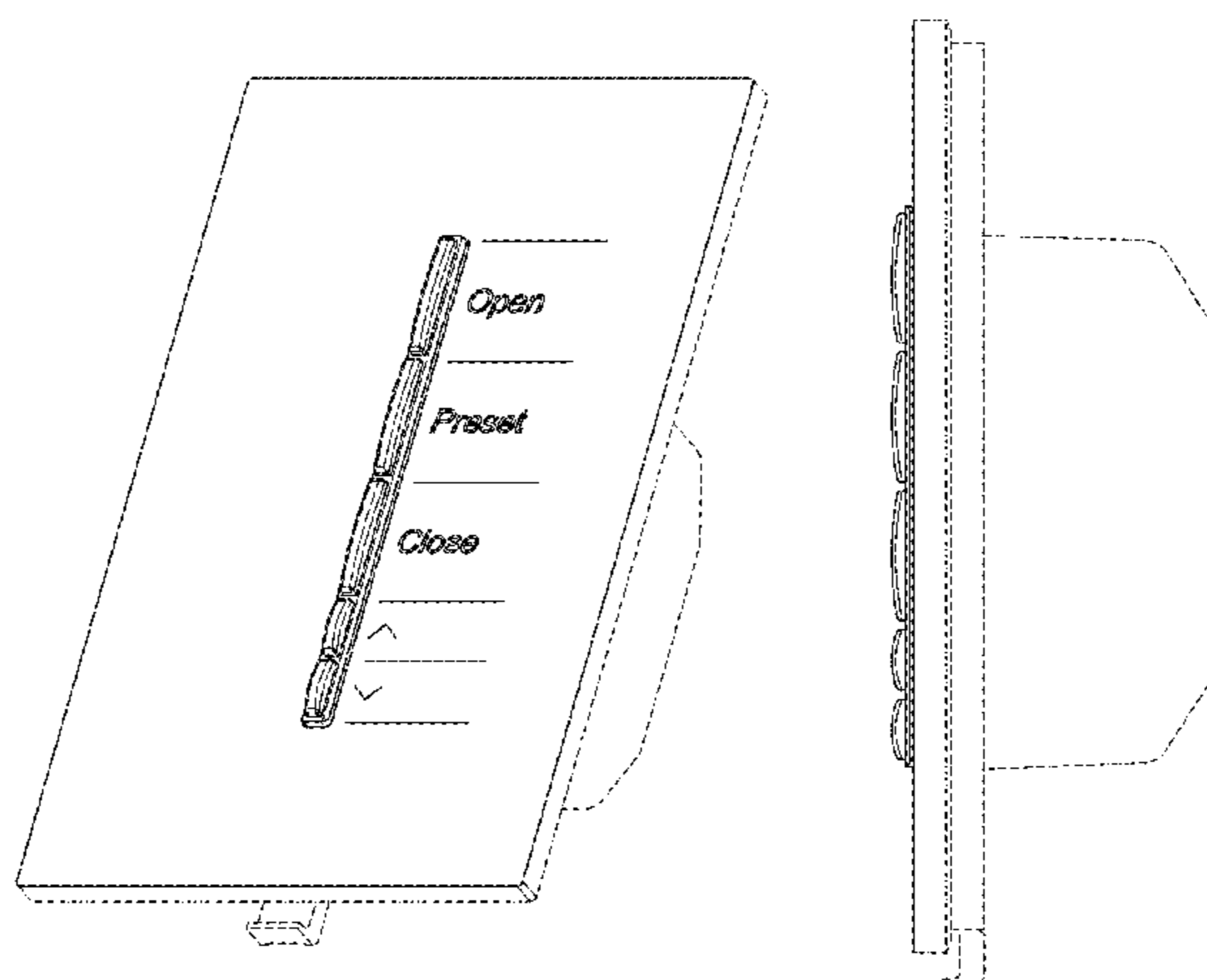

(56)

References Cited

U.S. PATENT DOCUMENTS

D678,850 S * 3/2013 Wisniewski D13/174
D705,179 S * 5/2014 Wisniewski D13/174
9,167,666 B1 * 10/2015 Billheimer H05B 37/02
9,389,769 B1 * 7/2016 O’Keeffe G06F 1/3262
2007/0216318 A1 * 9/2007 Altonen G02B 6/0001
315/209 R
2007/0272532 A1 * 11/2007 Pessina H02G 3/14
200/333
2007/0291010 A1 * 12/2007 Altonen H05B 39/085
345/173
2008/0258644 A1 10/2008 Altonen et al.
2009/0184652 A1 7/2009 Bollinger, Jr. et al.
2016/0035217 A1 * 2/2016 Camden G08C 17/02
340/12.5

OTHER PUBLICATIONS

U.S. Appl. No. 29/536,775, filed Aug. 19, 2015. (Unpublished).
U.S. Appl. No. 29/536,770, filed Aug. 19, 2015. (Unpublished).
U.S. Appl. No. 29/536,772, filed Aug. 19, 2015. (Unpublished).
U.S. Appl. No. 29/536,767, filed Aug. 19, 2015. (Unpublished).
U.S. Appl. No. 29/536,765, filed Aug. 19, 2015. (Unpublished).
U.S. Appl. No. 29/536,768, filed Aug. 19, 2015. (Unpublished).
U.S. Appl. No. 29/536,792, filed Aug. 19, 2015. (Unpublished).
U.S. Appl. No. 29/536,805, filed Aug. 19, 2015. (Unpublished).
U.S. Appl. No. 29/536,796, filed Aug. 19, 2015. (Unpublished).
U.S. Appl. No. 29/536,802, filed Aug. 19, 2015. (Unpublished).
U.S. Appl. No. 29/536,810, filed Aug. 19, 2015. (Unpublished).
U.S. Appl. No. 29/536,808, filed Aug. 19, 2015. (Unpublished).
U.S. Appl. No. 29/536,807, filed Aug. 19, 2015. (Unpublished).

* cited by examiner

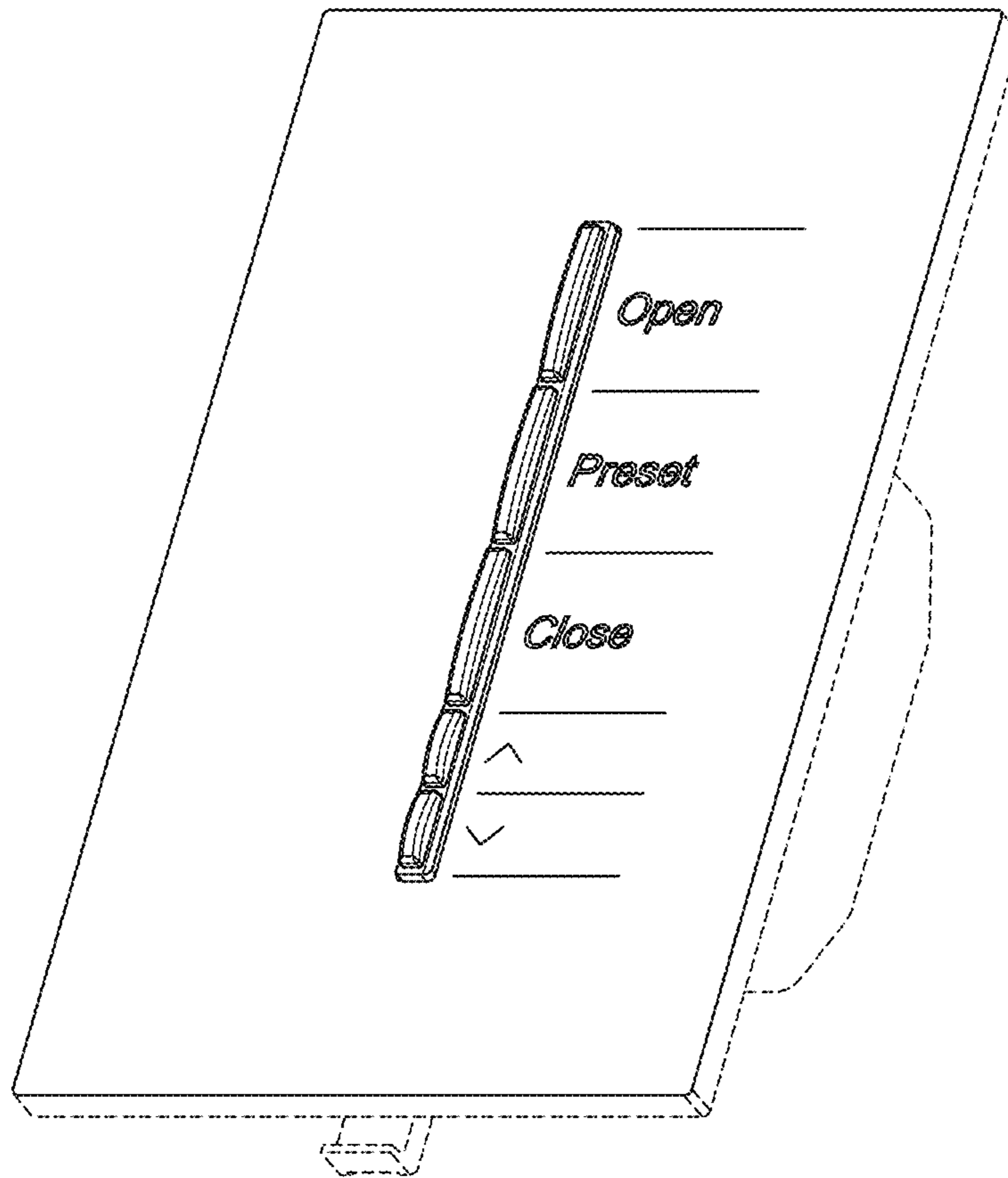

FIG. 1

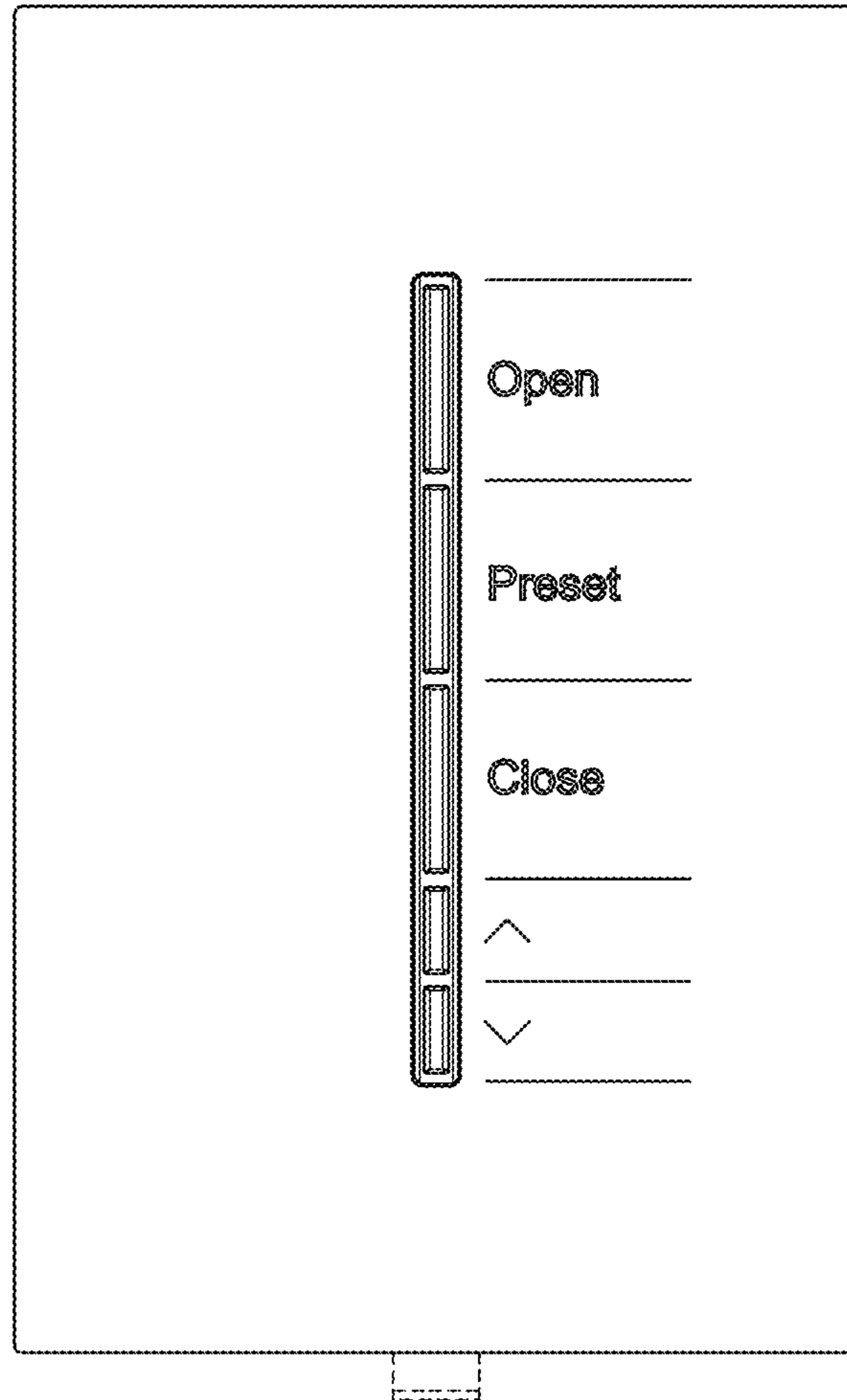

FIG. 2

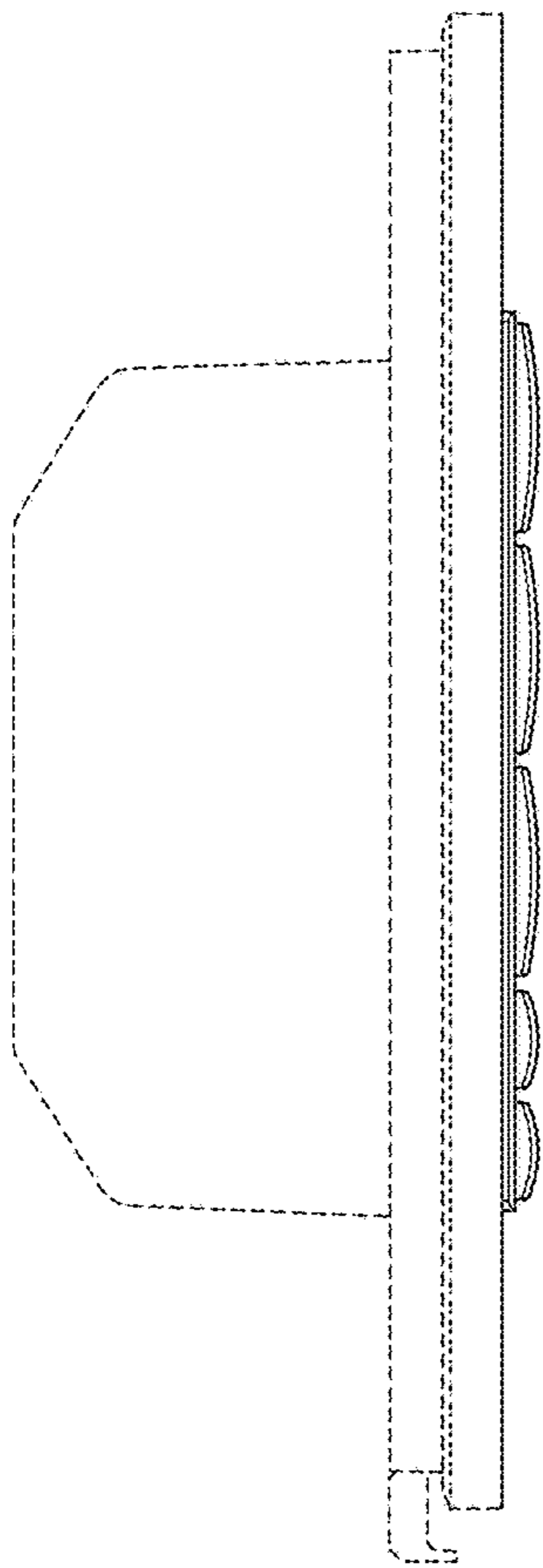

FIG. 3

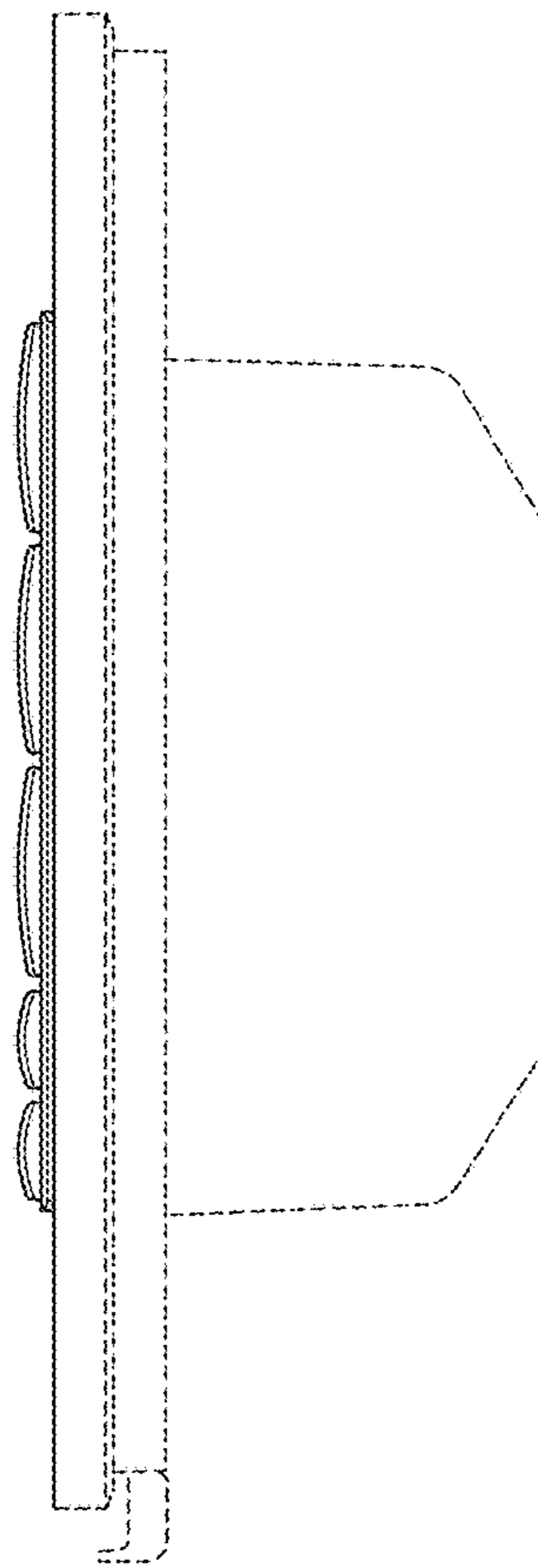

FIG. 4

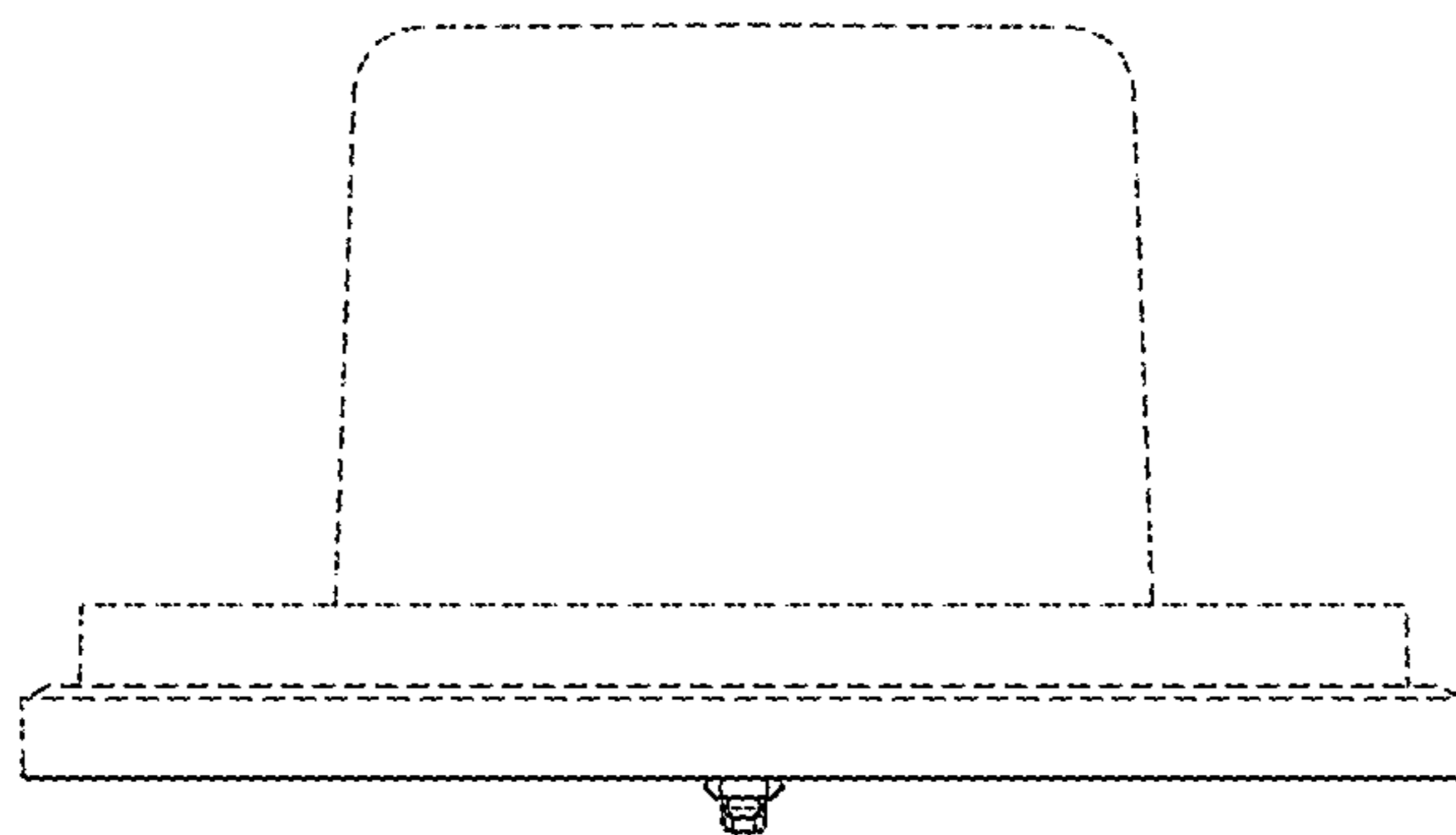

FIG. 5

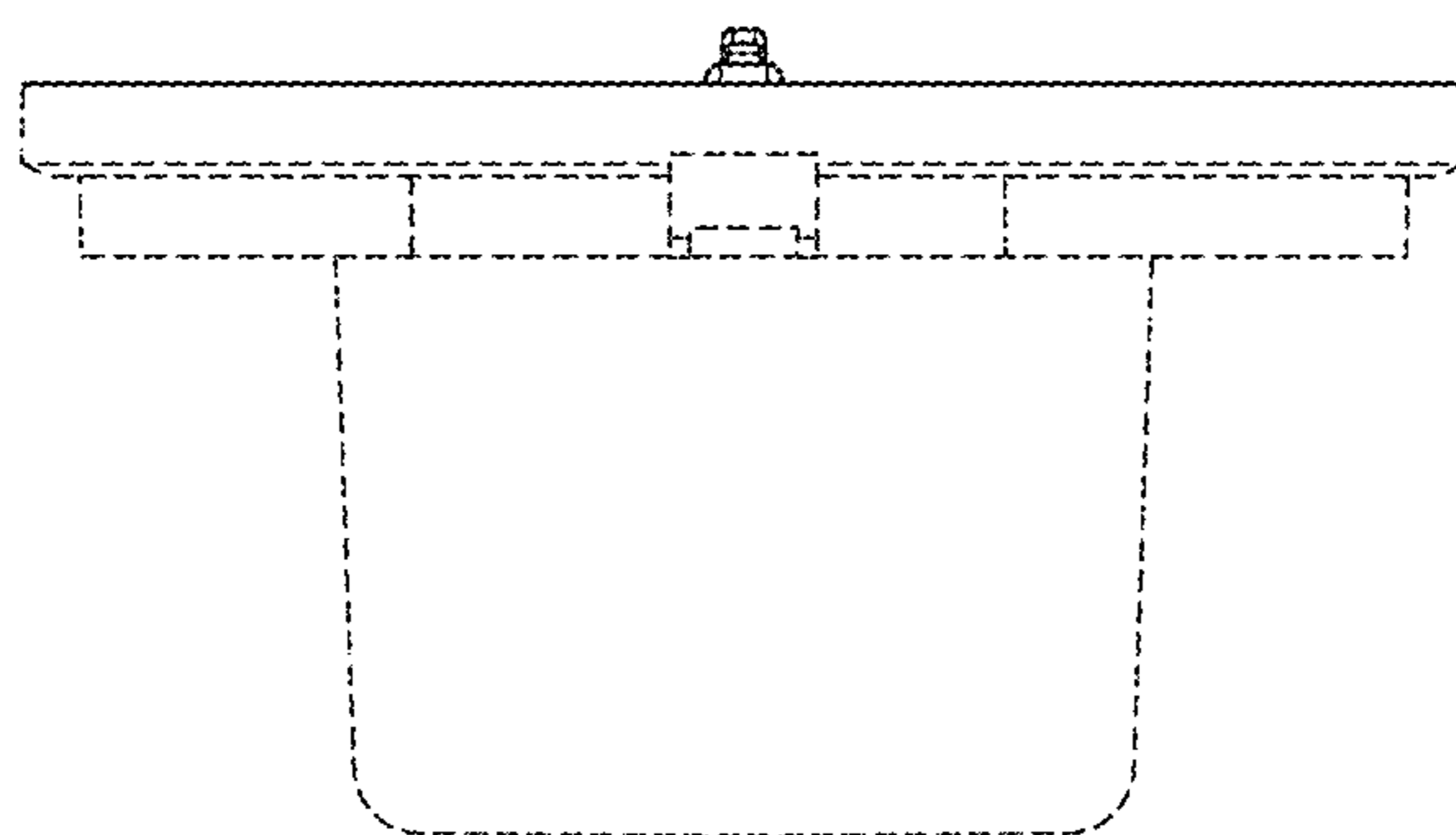

FIG. 6