



US00D784019S

(12) **United States Design Patent** (10) **Patent No.:** **US D784,019 S**
McLaughlin et al. (45) **Date of Patent:** **** Apr. 18, 2017**

(54) **ARTICLE HOLDING TRAY**
(71) Applicants: **Sonya McLaughlin**, Downingtown, PA (US); **Brian McLaughlin**, Downingtown, PA (US)
(72) Inventors: **Sonya McLaughlin**, Downingtown, PA (US); **Brian McLaughlin**, Downingtown, PA (US)
(**) Term: **15 Years**
(21) Appl. No.: **29/554,283**

D422,788 S *	4/2000	Carr	D3/307
D472,711 S *	4/2003	Chen	D3/313
D492,113 S *	6/2004	Bayer	D3/310
D495,139 S *	8/2004	Sullivan	D3/310
D550,459 S *	9/2007	Eskandry	D3/305
D550,962 S *	9/2007	Eskandry	D3/305
7,717,504 B2	5/2010	Centracco		
D633,296 S *	3/2011	Potts	D3/305
D681,984 S *	5/2013	Cramer	D6/513
8,727,435 B2	5/2014	Centracco		
D713,455 S *	9/2014	Chuang	D19/78
D752,345 S *	3/2016	Szucs	D3/305
D768,986 S *	10/2016	Parker	D3/310
D771,944 S *	11/2016	Epicureo	D3/305
2012/0286546 A1	11/2012	Ballard		

* cited by examiner

(22) Filed: **Feb. 10, 2016**
(51) **LOC (10) Cl.** **03-01**
(52) **U.S. Cl.**
USPC **D3/305**
(58) **Field of Classification Search**
USPC D3/273, 276, 286, 298, 299, 302, 303,
D3/304, 305, 307, 308, 309; D7/601,
D7/701; D19/75, 77, 90, 100
CPC A45C 3/001; A45C 2003/002; A45C 5/00;
A45C 5/02; B65D 1/22; B65D 43/162;
B65D 81/02; B65D 81/3813
See application file for complete search history.

Primary Examiner — Kelley Donnelly
(74) *Attorney, Agent, or Firm* — Goldstein Law Offices, P.C.

(57) **CLAIM**

The ornamental design for an article holding tray, as shown and described.

DESCRIPTION

FIG. 1 is a perspective view of article holding tray in full lines.
FIG. 2 is a top plan view of the article holding tray;
FIG. 3 is a bottom plan view thereof.
FIG. 4 is a front elevational view thereof.
FIG. 5 is a rear elevational view thereof.
FIG. 6 is a right side elevational view thereof; and,
FIG. 7 is a left side elevational view thereof.

1 Claim, 4 Drawing Sheets

(56) **References Cited**

U.S. PATENT DOCUMENTS

1,050,205 A	1/1913	Conley
2,526,576 A	10/1950	Nelson
2,540,685 A	2/1951	Mayer
2,766,455 A	10/1956	Klaine
3,597,763 A	8/1971	Bienvenu
4,165,123 A	8/1979	Hutson

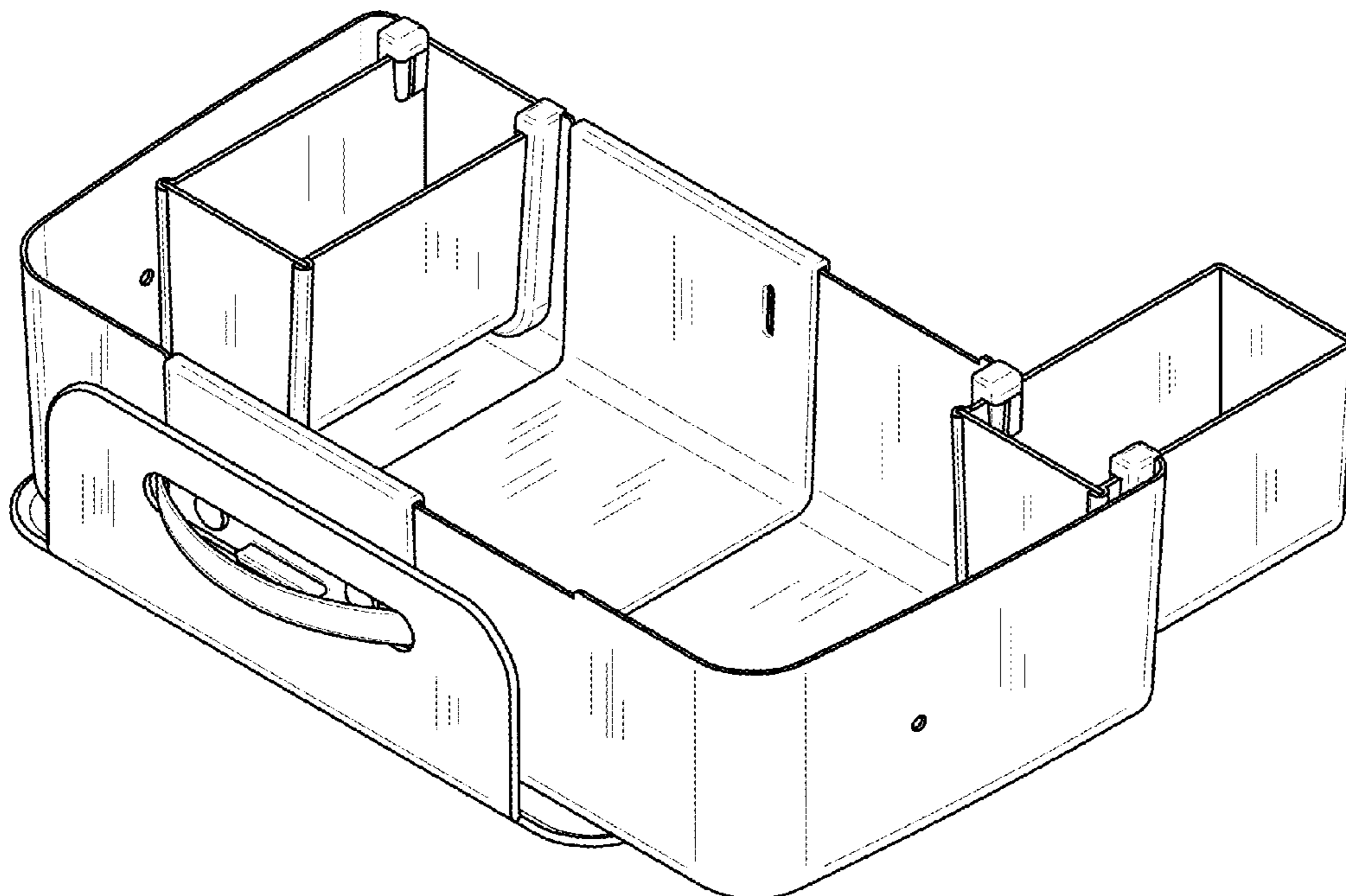

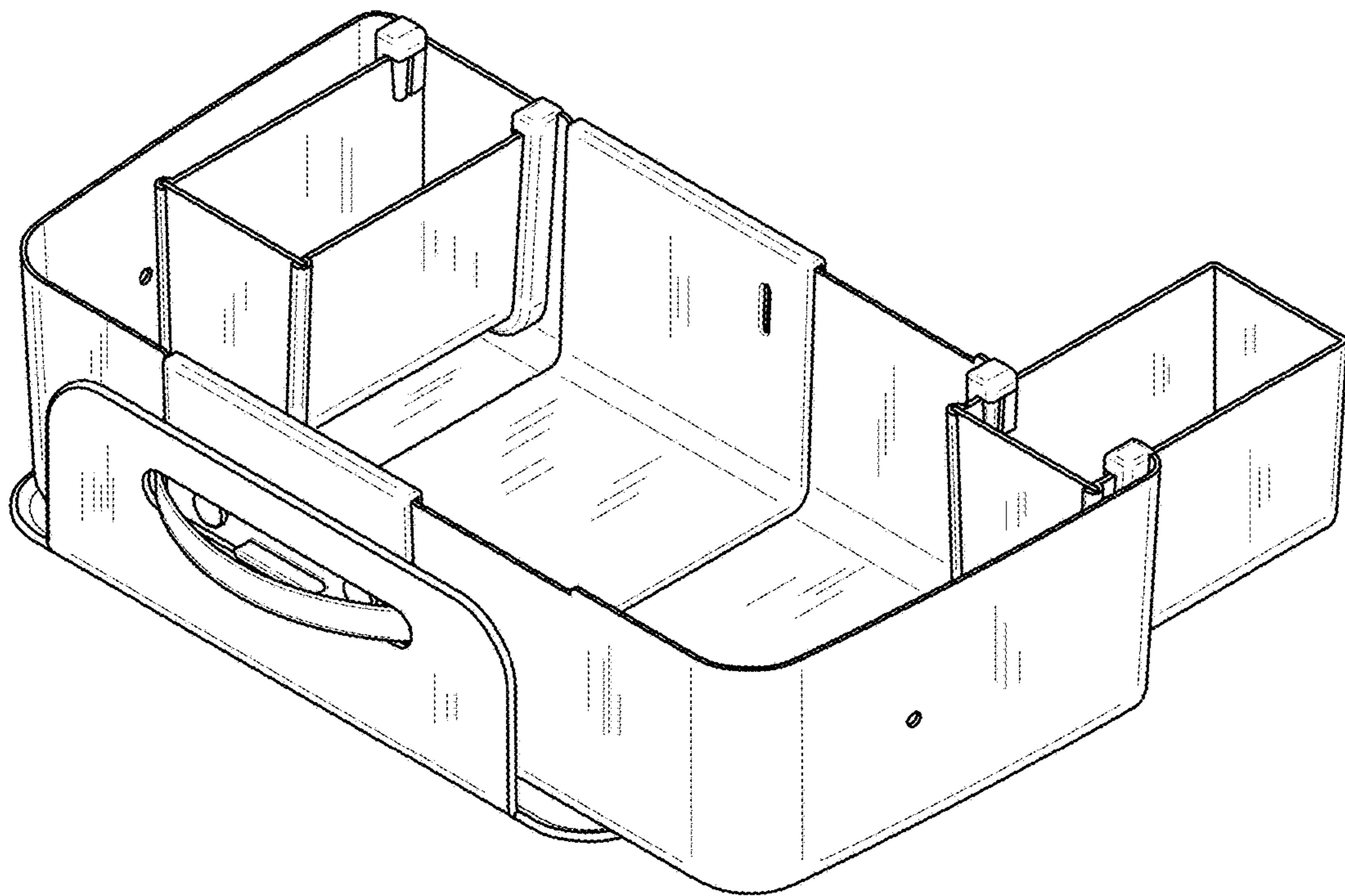

FIG. 1

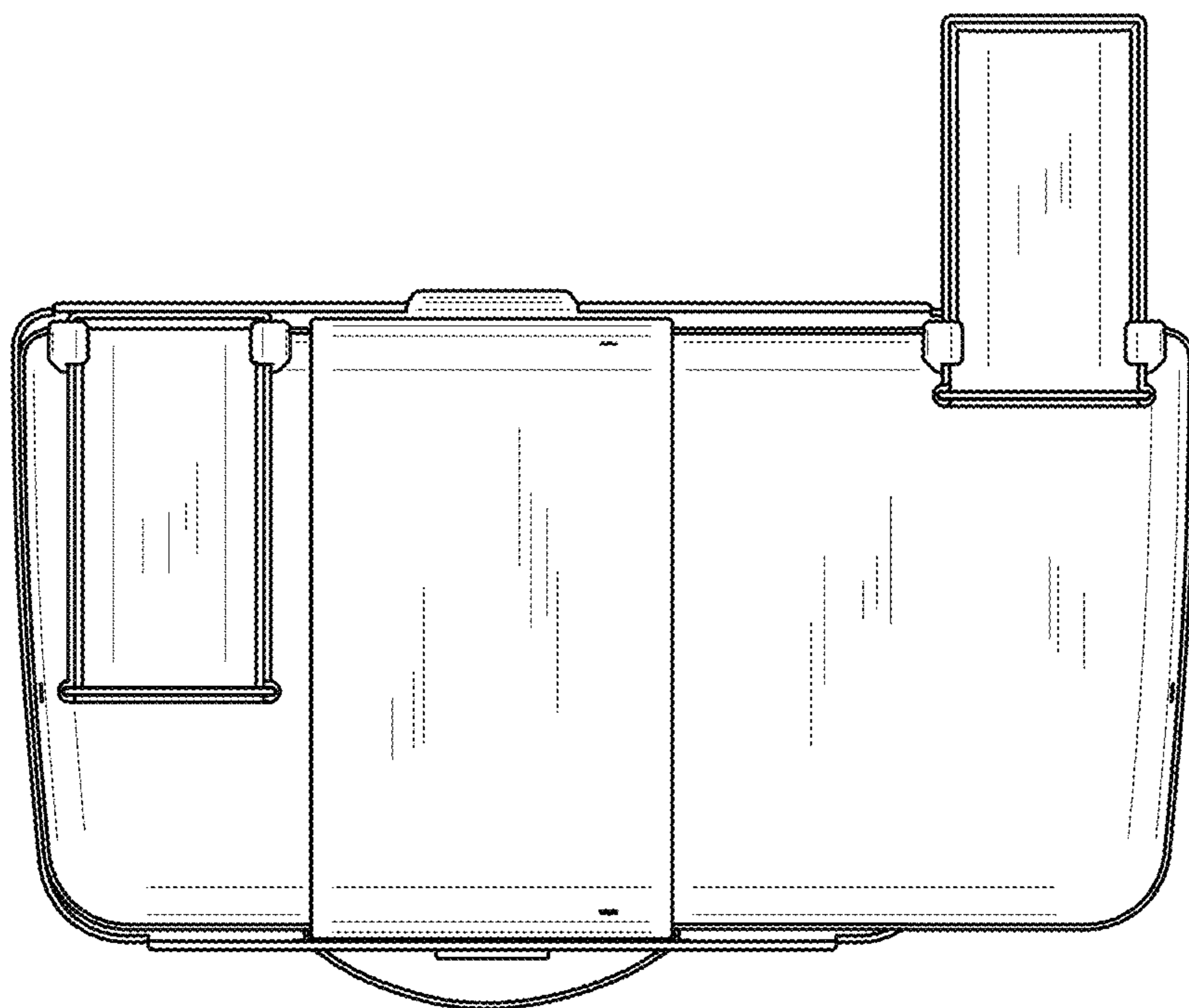

FIG. 2

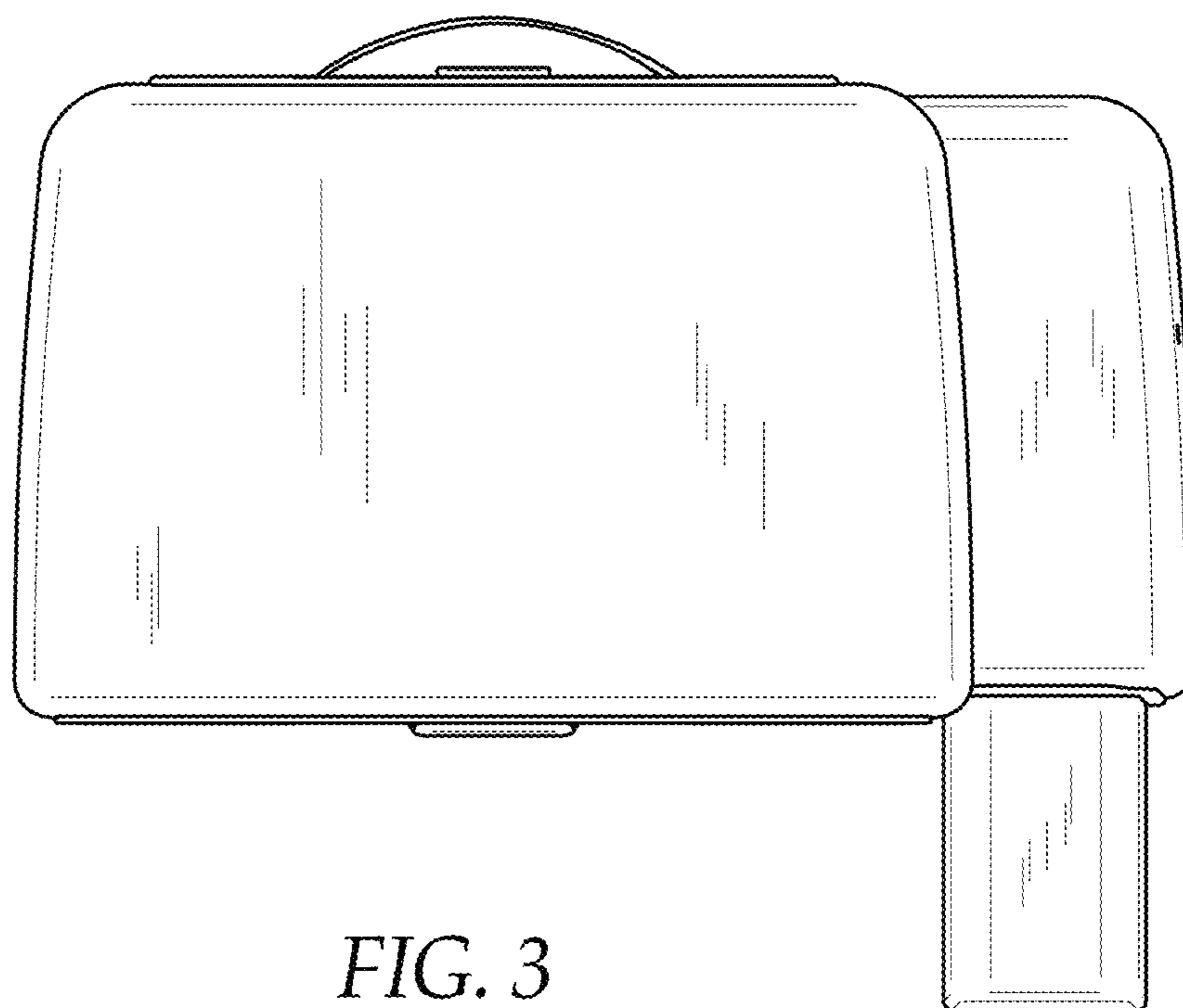

FIG. 3

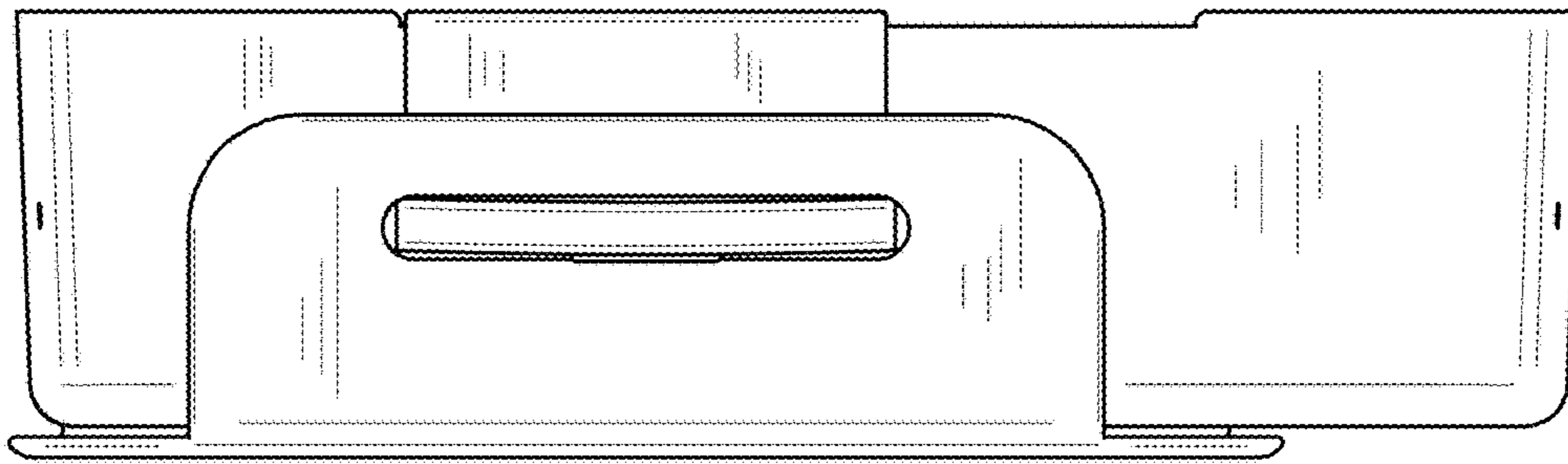

FIG. 4

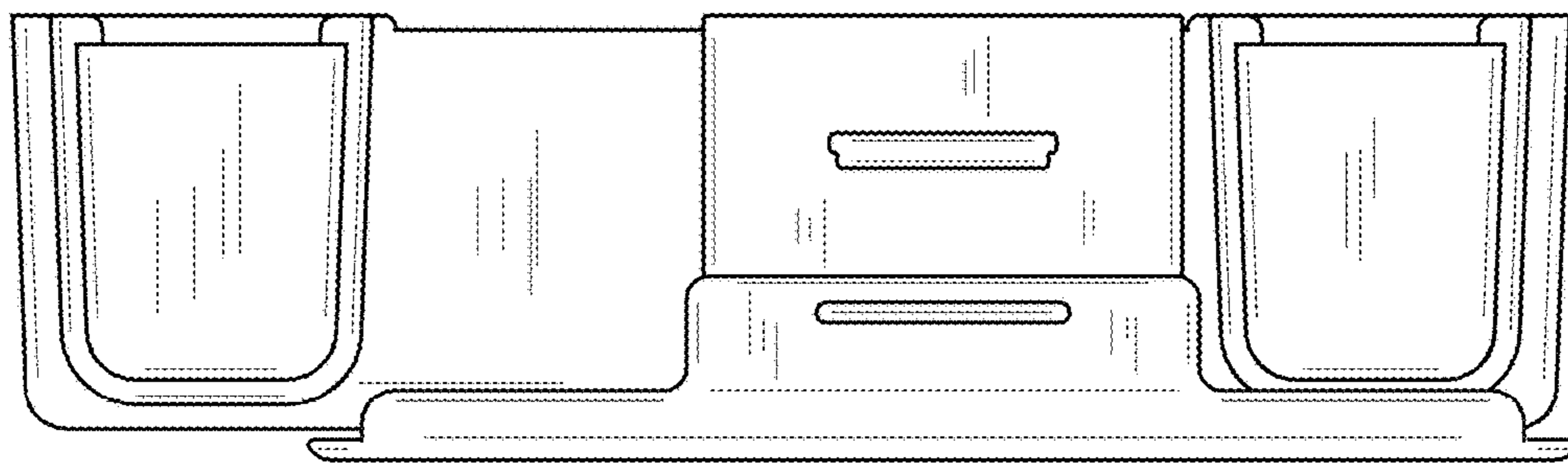

FIG. 5

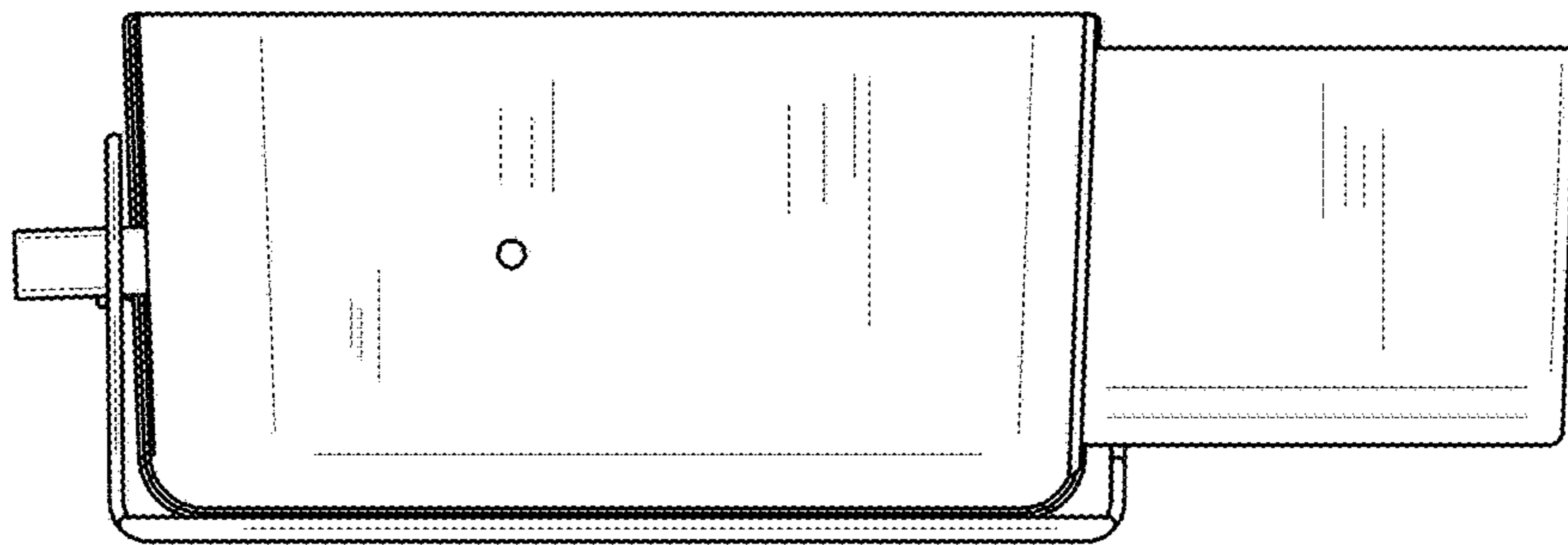

FIG. 6

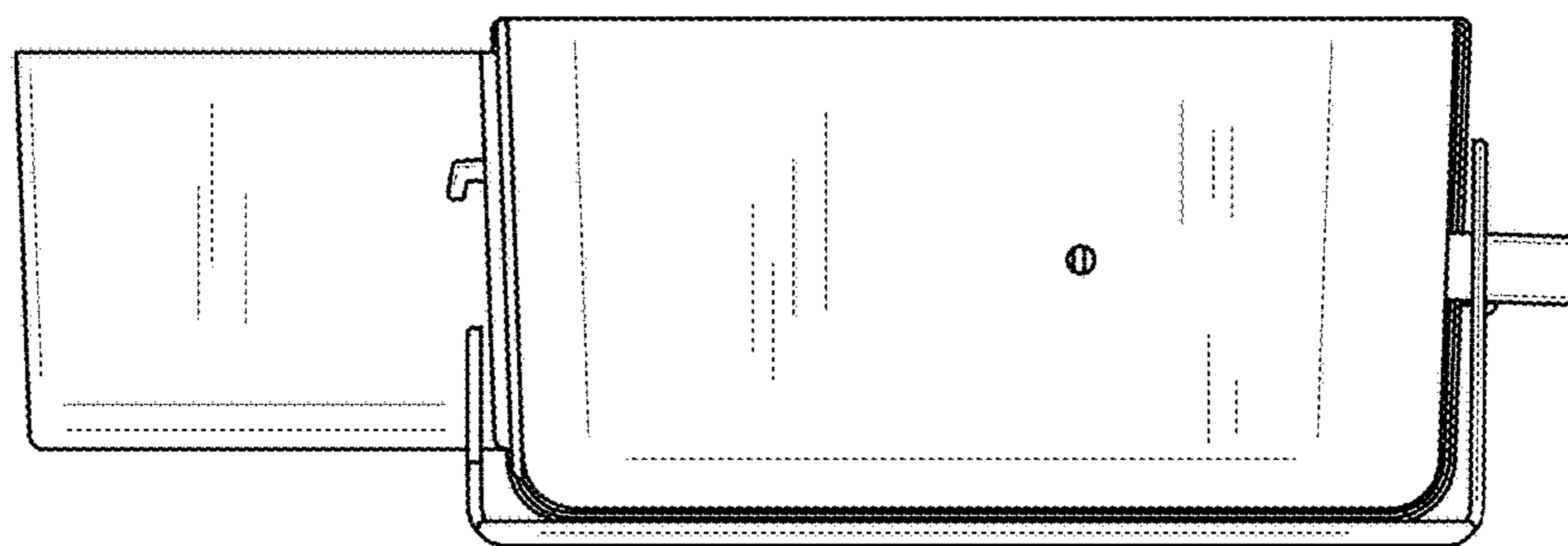

FIG. 7