



US00D783944S

(12) **United States Design Patent**
Lomax

(10) **Patent No.:** **US D783,944 S**
(45) **Date of Patent:** **** Apr. 18, 2017**

- (54) **GARMENT**
- (71) Applicant: **NIKE, Inc.**, Beaverton, OR (US)
- (72) Inventor: **Jessica Lomax**, London (GB)
- (73) Assignee: **NIKE, Inc.**, Beaverton, OR (US)
- (**) Term: **14 Years**
- (21) Appl. No.: **29/525,800**
- (22) Filed: **May 3, 2015**
- (51) **LOC (10) Cl.** **02-02**
- (52) **U.S. Cl.**
USPC **D2/829**
- (58) **Field of Classification Search**
USPC D2/828-831, 839-840; 2/69.5, 70, 84,
2/93, 96-97, 102, 108, 205
CPC .. A41D 13/00; A41D 13/001; A41D 13/0012;
A41D 13/08; A41D 27/10; A41D 27/04;
A41D 27/20; A41D 15/04; A41D 15/007;
A42B 1/048
See application file for complete search history.

D622,932 S	9/2010	Gettler	
D625,078 S	10/2010	Scott-Curran	
D626,725 S	11/2010	Snyder et al.	
D633,692 S	3/2011	Lawrence et al.	
D635,332 S	4/2011	DeRobertis	
D654,659 S	2/2012	Scott-Curran	
D662,284 S	6/2012	Lam	
D665,152 S	8/2012	Morales	
D685,160 S	7/2013	Savage	
D686,391 S	7/2013	Beber et al.	
D695,495 S	12/2013	Astacio et al.	
D698,523 S	* 2/2014	Roberts	D2/829
D701,368 S	3/2014	Borovicka et al.	
D703,922 S	* 5/2014	Roberts	D2/829
D704,924 S	5/2014	Roberts et al.	
D721,467 S	1/2015	Tref	

(Continued)

Primary Examiner — Eric Goodman
Assistant Examiner — Amy Wierenga
(74) *Attorney, Agent, or Firm* — Banner & Witcoff, Ltd.

(57) **CLAIM**

The ornamental design for a garment, as shown and described.

DESCRIPTION

FIG. 1 is a front perspective view of a garment showing my new design in an in-use configuration;
FIG. 2 is a front view thereof;
FIG. 3 is a rear view thereof;
FIG. 4 is a side view thereof;
FIG. 5 is a second side view thereof;
FIG. 6 is a top view thereof; and,
FIG. 7 is a bottom view thereof.
The broken lines depict portions of the article that form no part of the claim. The unshaded regions demarcated by broken lines, represent unclaimed portions of the garment that form no part of the claim.

1 Claim, 6 Drawing Sheets

- (56) **References Cited**
U.S. PATENT DOCUMENTS
- D86,519 S 3/1932 Graber
- D102,656 S 1/1937 Saldin
- 4,149,272 A * 4/1979 Maeshima A41D 3/00
2/102
- D414,913 S * 10/1999 Katz D2/829
- D426,937 S 6/2000 Auster et al.
- 6,298,485 B1 * 10/2001 Heller A41D 3/005
2/126
- D479,902 S * 9/2003 Brown D2/831
- D553,329 S 10/2007 Wager
- D619,783 S 7/2010 Jones et al.
- D619,785 S 7/2010 Jones et al.

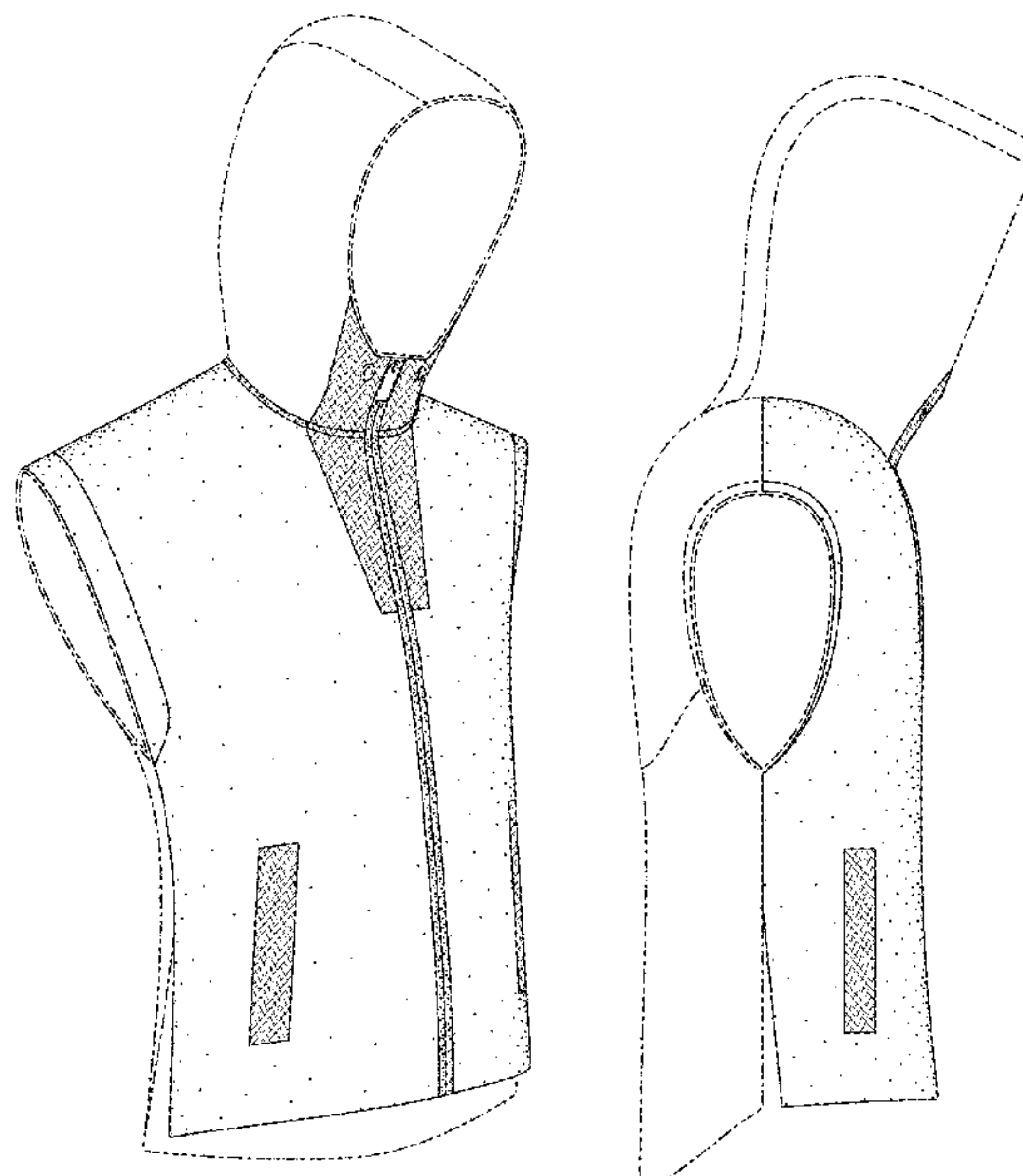

(56)

References Cited

U.S. PATENT DOCUMENTS

D728,199 S	5/2015	Barski	
D744,724 S *	12/2015	Borovicka	D2/828
D746,551 S *	1/2016	Ingram	D2/839
D747,075 S *	1/2016	Ingram	D2/831
D756,602 S *	5/2016	Darmour	D2/828
D758,700 S *	6/2016	Borovicka	D2/831
D762,048 S *	7/2016	Lomax	D2/829
D762,346 S *	8/2016	Lomax	D2/829
D770,730 S *	11/2016	Borovicka	D2/828
D772,533 S *	11/2016	Borovicka	D2/731
D772,534 S *	11/2016	Borovicka	D2/731

* cited by examiner

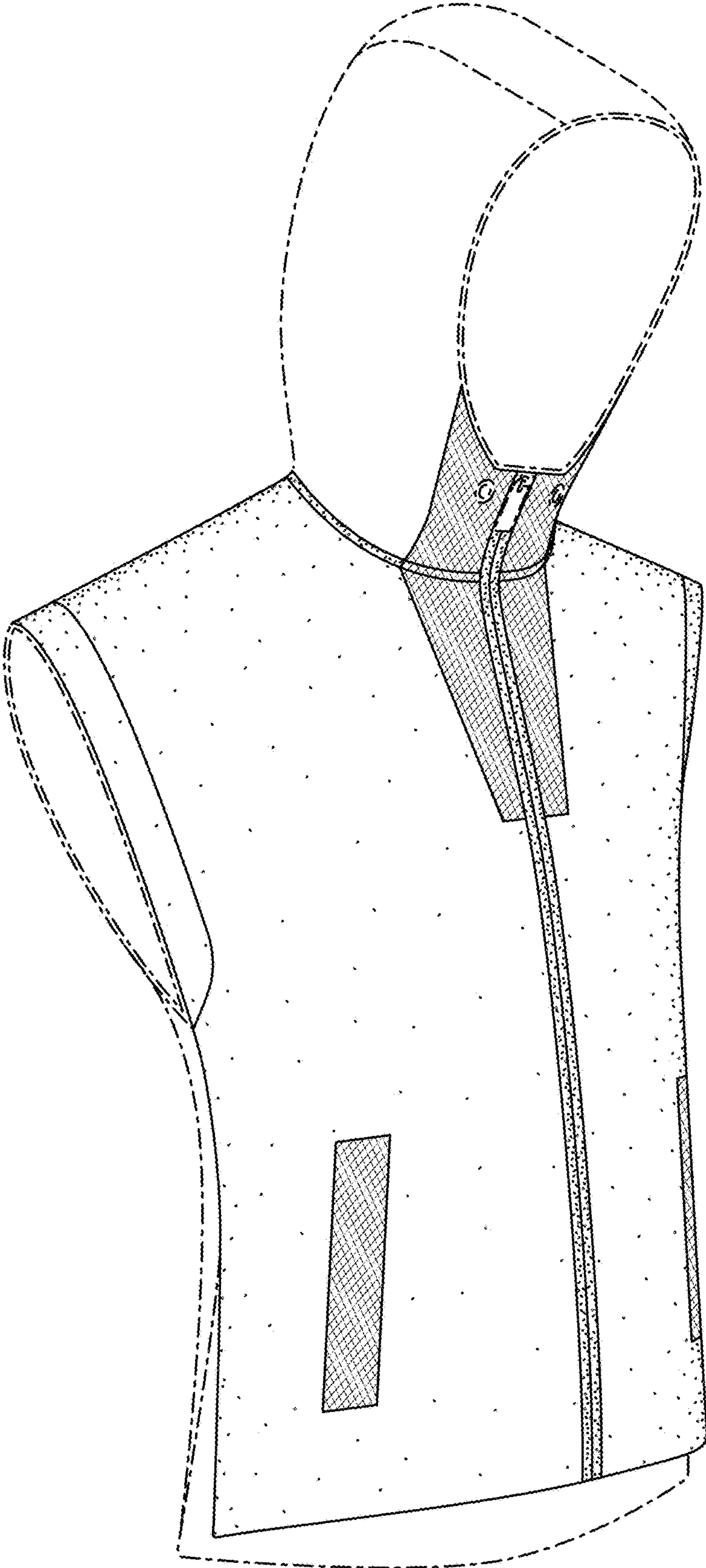

FIG. 1

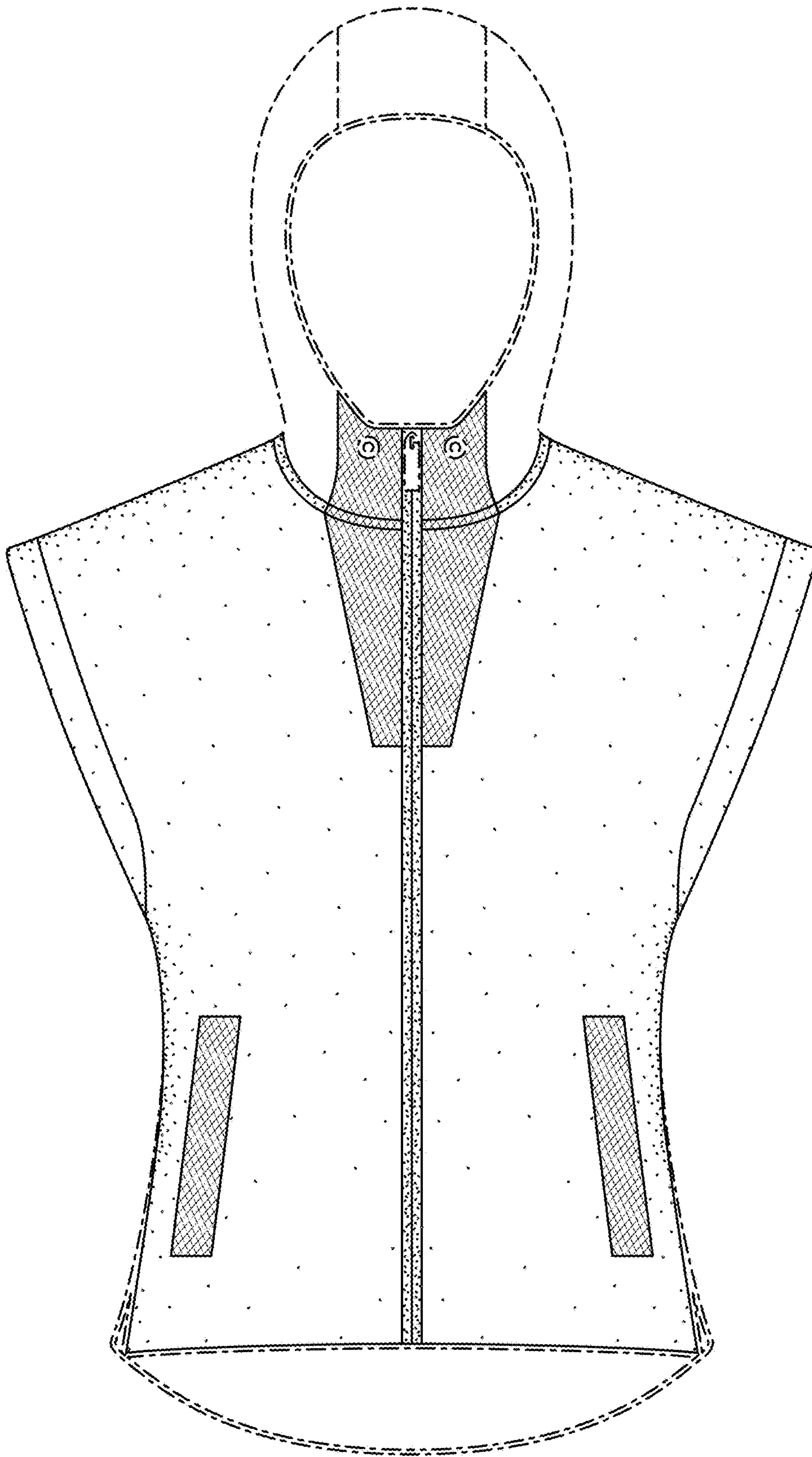

FIG. 2

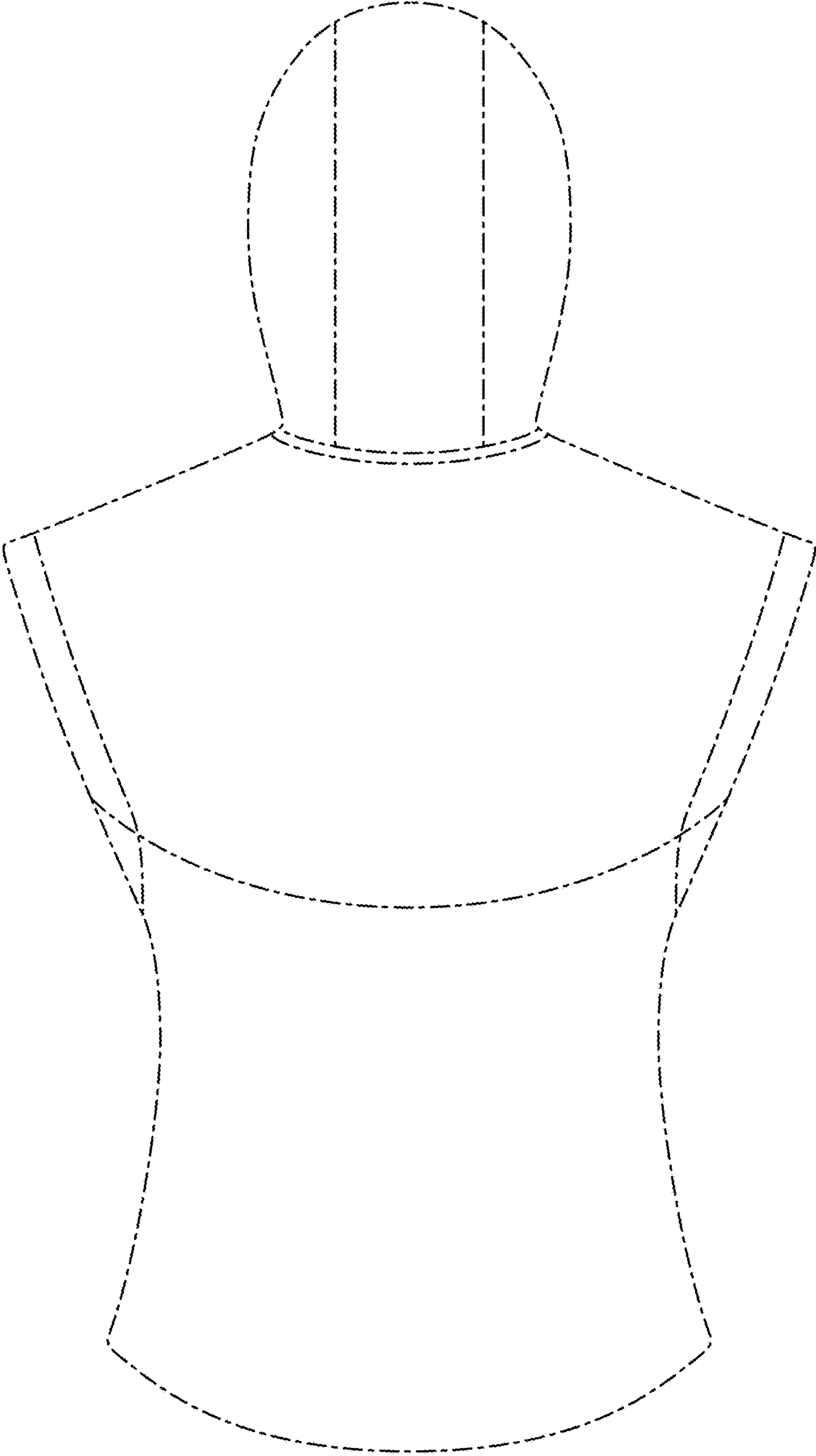

FIG. 3

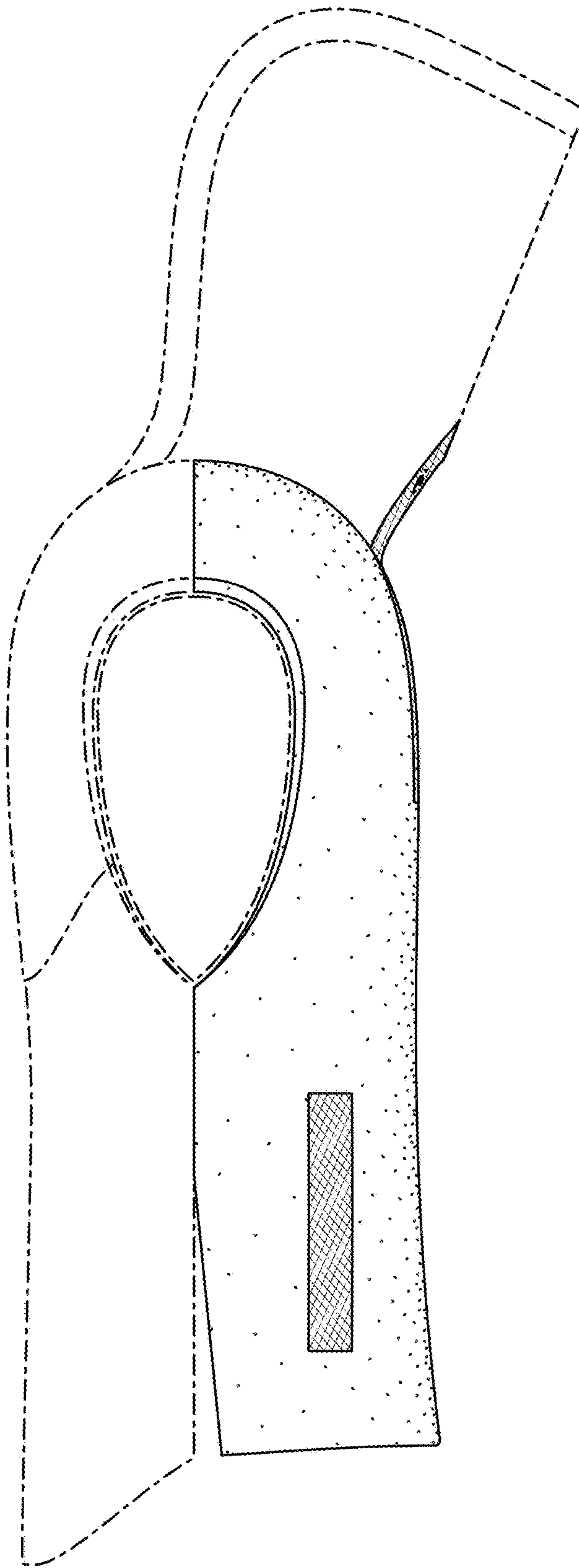

FIG. 4

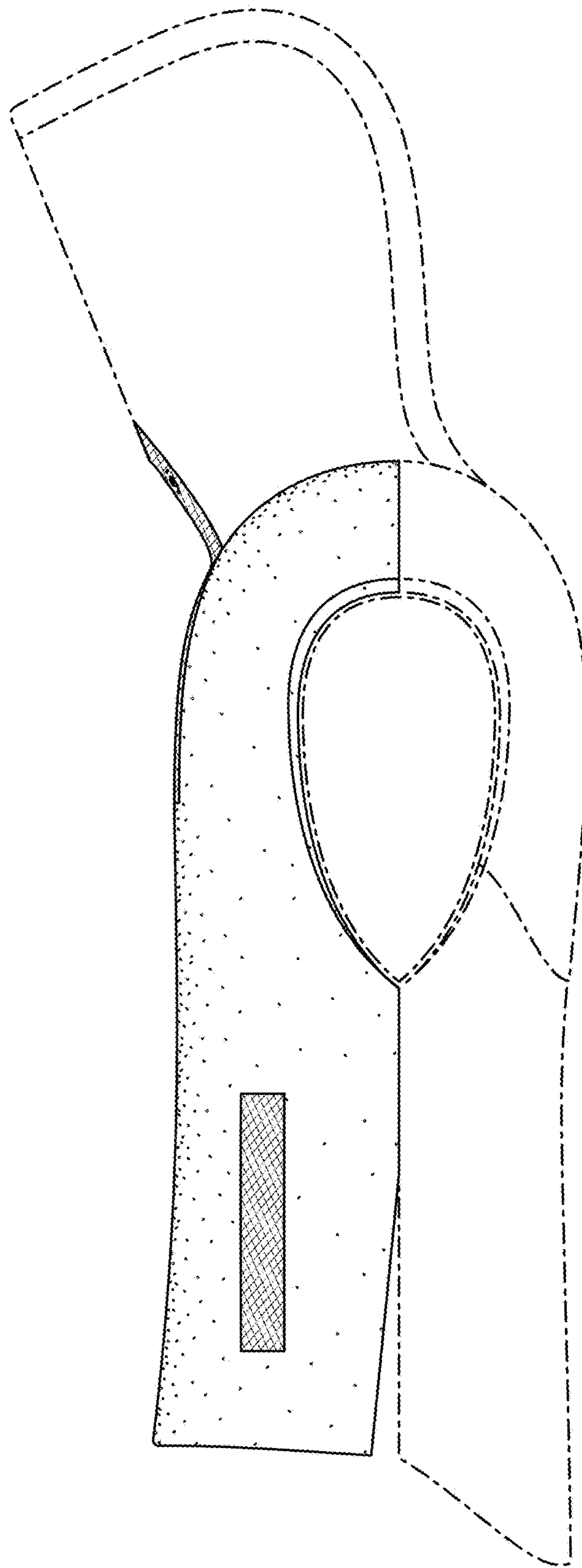

FIG. 5

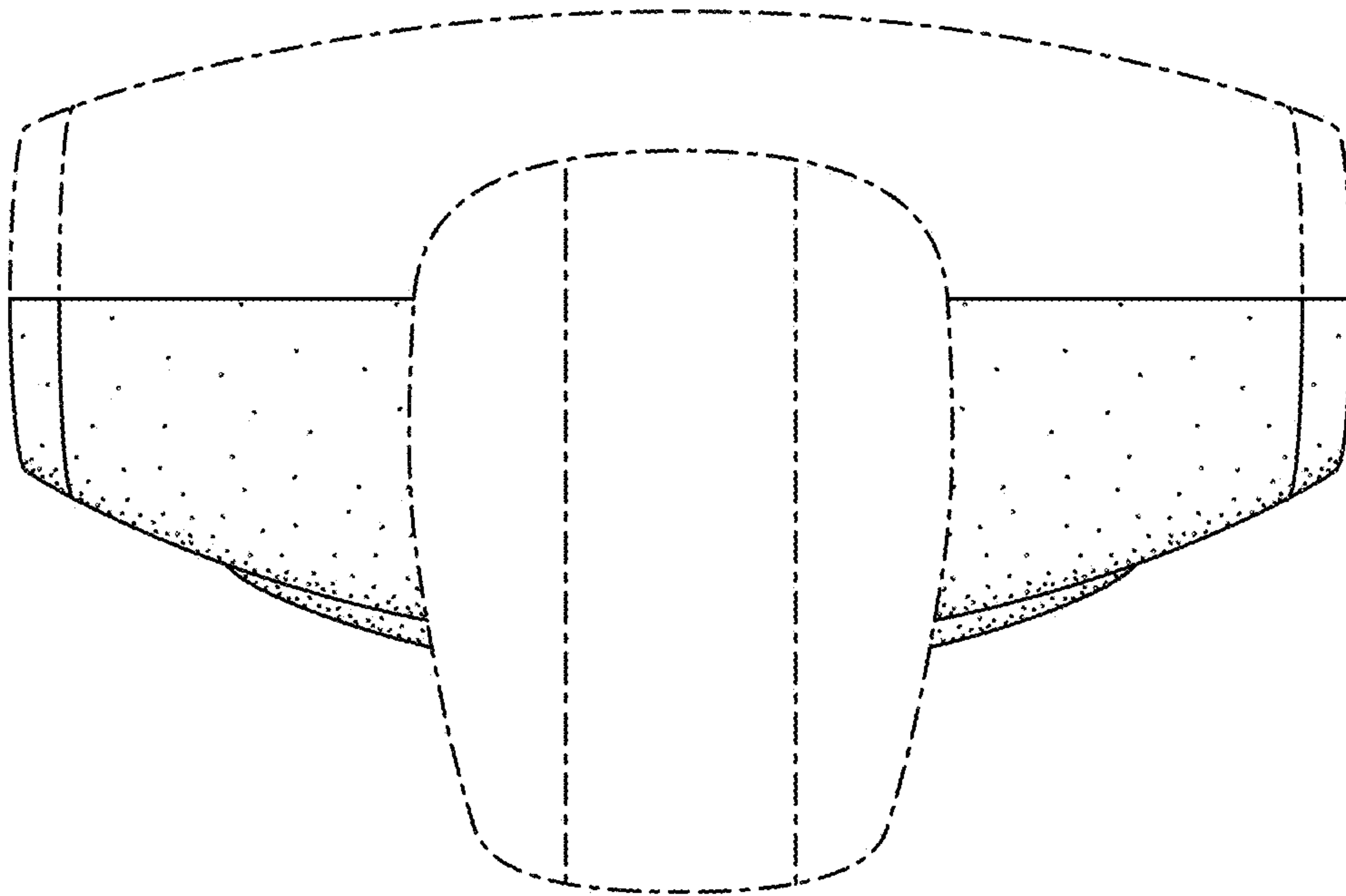

FIG. 6

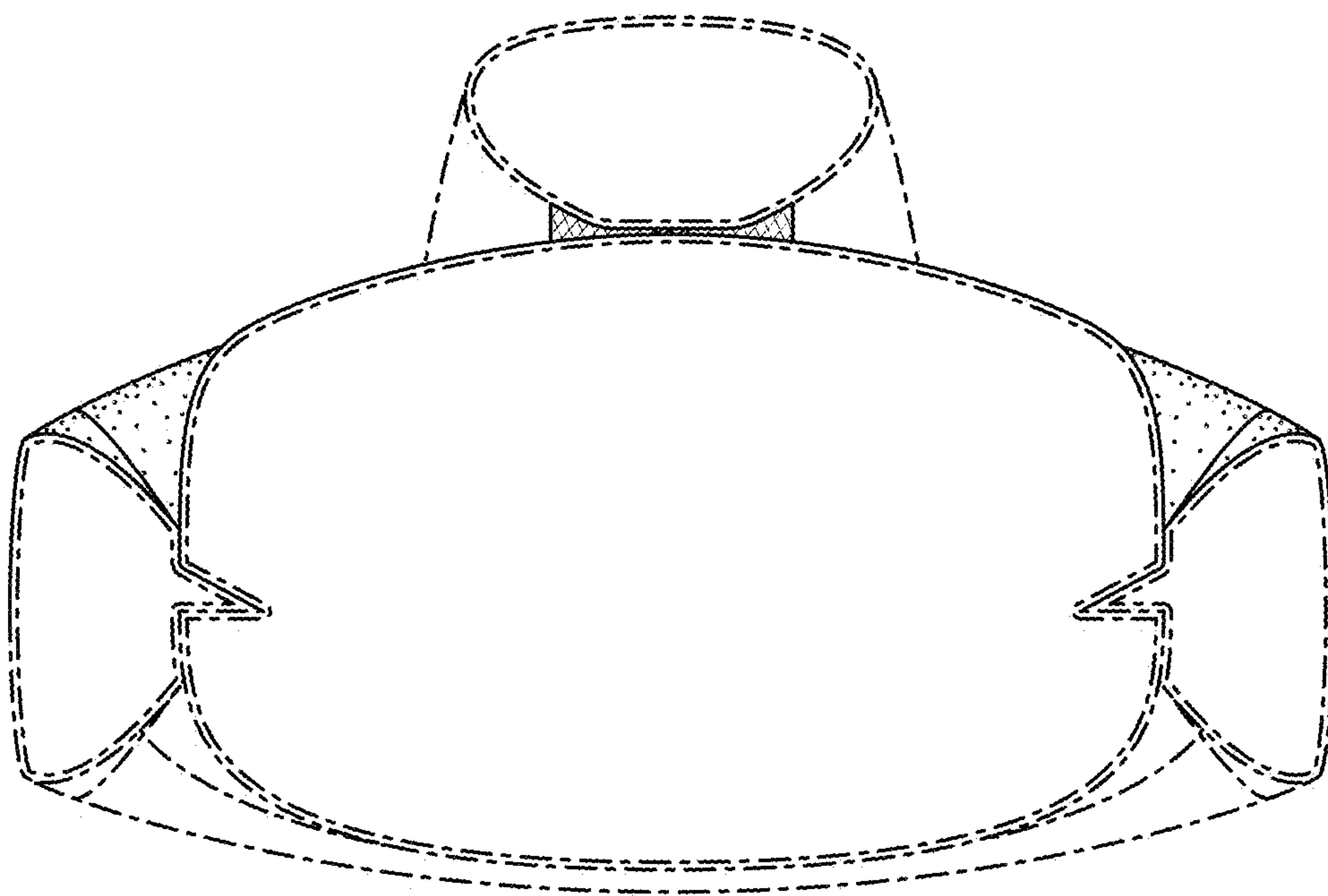

FIG. 7