



US00D783932S

(12) **United States Design Patent**
Cruthers et al.

(10) **Patent No.:** **US D783,932 S**
(45) **Date of Patent:** **** Apr. 18, 2017**

(54) **SHIRT**

(71) Applicant: **NIKE, Inc.**, Beaverton, OR (US)

(72) Inventors: **Sara Cruthers**, Beaverton, OR (US);
David Turner, Beaverton, OR (US);
Jaison Williams, Beaverton, OR (US)

(73) Assignee: **NIKE, Inc.**, Beaverton, OR (US)

(**) Term: **15 Years**

(21) Appl. No.: **29/530,055**

(22) Filed: **Jun. 12, 2015**

(51) **LOC (10) Cl.** **02-02**

(52) **U.S. Cl.**
USPC **D2/731**

(58) **Field of Classification Search**
USPC D2/700, 702–706, 708, 717, 720, 721,
D2/728–732, 735–737, 785, 840; 2/112,
2/113

(Continued)

(56) **References Cited**

U.S. PATENT DOCUMENTS

1,158,938 A 11/1915 Kronthal
1,202,332 A 10/1916 Tschirgi

(Continued)

FOREIGN PATENT DOCUMENTS

EP 0893072 A1 1/1999
GB 1281848 A 7/1972

OTHER PUBLICATIONS

“Dress Shirts Split Yoke vs One Piece Yoke,” Proper Cloth,
propercloth.com, 2015. Available at: [http://propercloth.com/refer-
ence/dress-shirts-split-yoke-vs-one-piece-yoke/](http://propercloth.com/refer-
ence/dress-shirts-split-yoke-vs-one-piece-yoke/).

(Continued)

Primary Examiner — Wan Laymon

Assistant Examiner — Clint A Samuel

(74) *Attorney, Agent, or Firm* — Shook, Hardy & Bacon
L.L.P.

(57) **CLAIM**

The ornamental design for a shirt, as shown and described.

DESCRIPTION

FIG. 1 is a front view of a shirt showing a first embodiment according to the present design;
FIG. 2 is a back view thereof;
FIG. 3 is a right side view thereof;
FIG. 4 is a top-down view thereof;
FIG. 5 is a front view of a shirt showing a second embodiment according to the present design;
FIG. 6 is a back view thereof;
FIG. 7 is a right side view thereof;
FIG. 8 is a top-down view thereof;
FIG. 9 is a front view of a shirt showing a third embodiment according to the present design;
FIG. 10 is a back view thereof;
FIG. 11 is a right side view thereof;
FIG. 12 is a top-down view thereof;
FIG. 13 is a front view of a shirt according to a fourth embodiment according to the present design;
FIG. 14 is a back view thereof;
FIG. 15 is a right side view thereof;
FIG. 16 is a top-down view thereof;
FIG. 17 is a front view of a shirt according to a fifth embodiment according to the present design;
FIG. 18 is a back view thereof;
FIG. 19 is a right side view thereof;
FIG. 20 is a top-down view thereof;
FIG. 21 is a front view of a shirt according to a sixth embodiment according to the present design;
FIG. 22 is a back view thereof;
FIG. 23 is a right side view thereof; and,
FIG. 24 is a top-down view thereof.

The evenly spaced broken lines shown in the drawings are directed to environment, are for informational purposes only, and form no part of the claimed design.

The long and short broken lines are boundary lines, which define the bounds of the claimed design. These boundaries

(Continued)

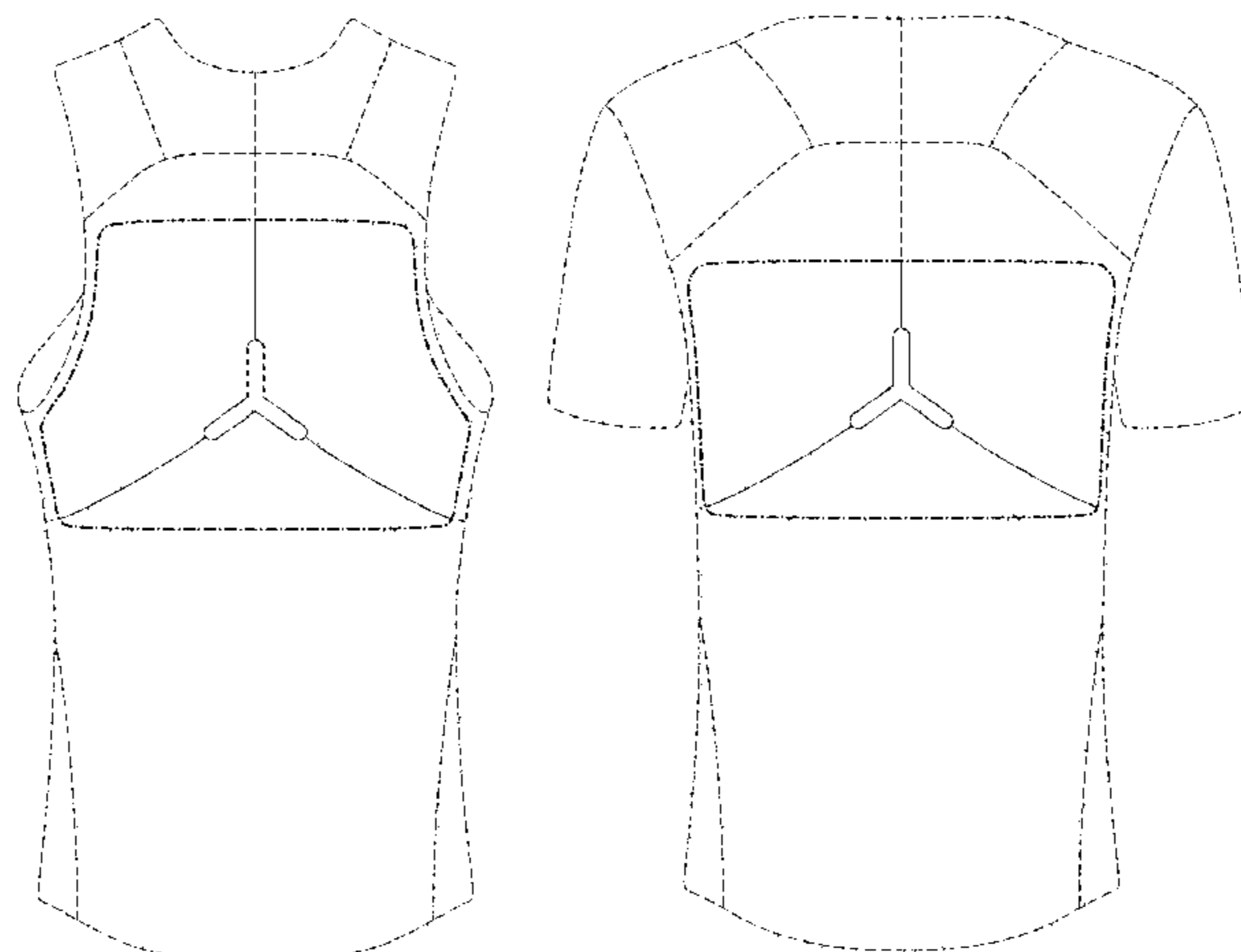

do not exist in reality in the article embodying the design. It is understood that the claimed design extends to these boundaries but does not include the boundaries.

The surface shading on the claimed portion is provided only to indicate the character and/or any contour or curvature of the surfaces. They do not indicate color, texture, markings that actually exist thereon, indicia, graphic representations, surface treatment, or any other ornamentation applied to the article.

1 Claim, 24 Drawing Sheets

(58) **Field of Classification Search**

CPC A41B 1/00; A41B 9/00; A41B 9/06; A41D 7/00

See application file for complete search history.

(56) **References Cited**

U.S. PATENT DOCUMENTS

1,208,193	A	12/1916	Nightingale	
2,126,186	A	8/1938	Friedland	
2,308,339	A *	1/1943	Mendenhall	A41B 9/06 2/113
2,341,797	A	2/1944	Lesser	
3,939,845	A *	2/1976	Guidoni	A41D 7/00 2/67

4,208,742	A	6/1980	Maos	
4,635,301	A	1/1987	Sulser	
5,083,315	A	1/1992	Dillon, Jr.	
5,349,704	A	9/1994	Masters	
5,487,189	A	1/1996	Bell	
6,058,507	A *	5/2000	Klimenko	A41D 7/003 2/67
D457,709	S	5/2002	Davis	
D526,763	S	8/2006	Tanner	
D580,633	S *	11/2008	Cross	D2/840
D619,782	S *	7/2010	Rhodes	D2/717
D620,228	S *	7/2010	Jones	D2/717
D627,134	S *	11/2010	Rhodes	D2/700
D628,771	S *	12/2010	Kanada	D2/717
D655,895	S *	3/2012	Petitt	D2/840
D746,552	S *	1/2016	Brown	D2/717
D770,727	S *	11/2016	Brown	D2/731
2007/0294801	A1	12/2007	Furgerson et al.	
2008/0078009	A1	4/2008	Black et al.	
2010/0186138	A1	7/2010	Hale	
2012/0324618	A1	12/2012	Dieffenbacher	
2015/0040286	A1	2/2015	Schultz et al.	
2015/0320123	A1 *	11/2015	Kosmala	A41D 7/00 2/67

OTHER PUBLICATIONS

Jess, "Reebok clothing review & giveaway," Blonde Ponytail, May 23, 2013. Available at: <http://blondeponytail.com/2013/05/reebok-clothing-review-giveaway/>.

* cited by examiner

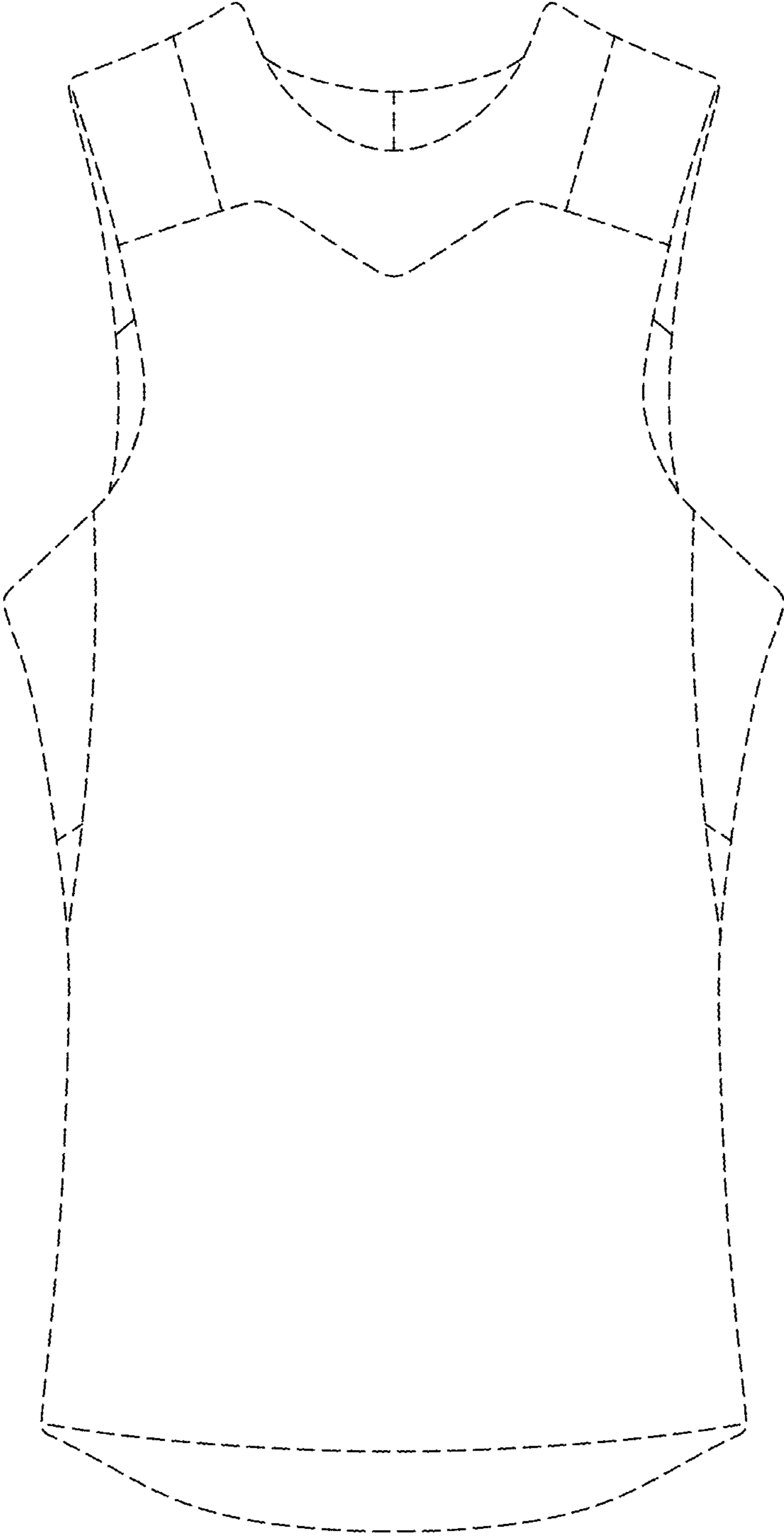

FIG. 1

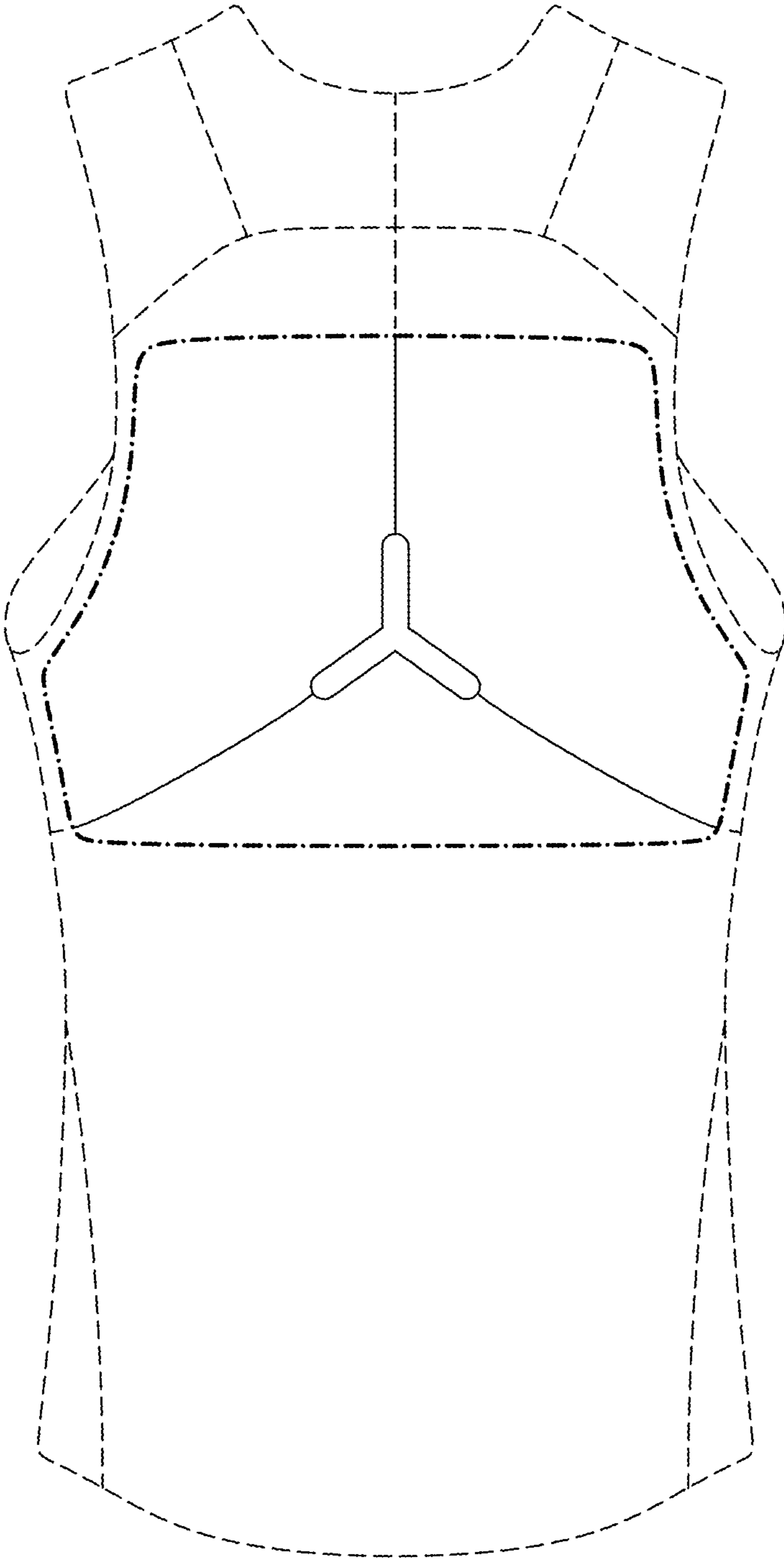

FIG. 2

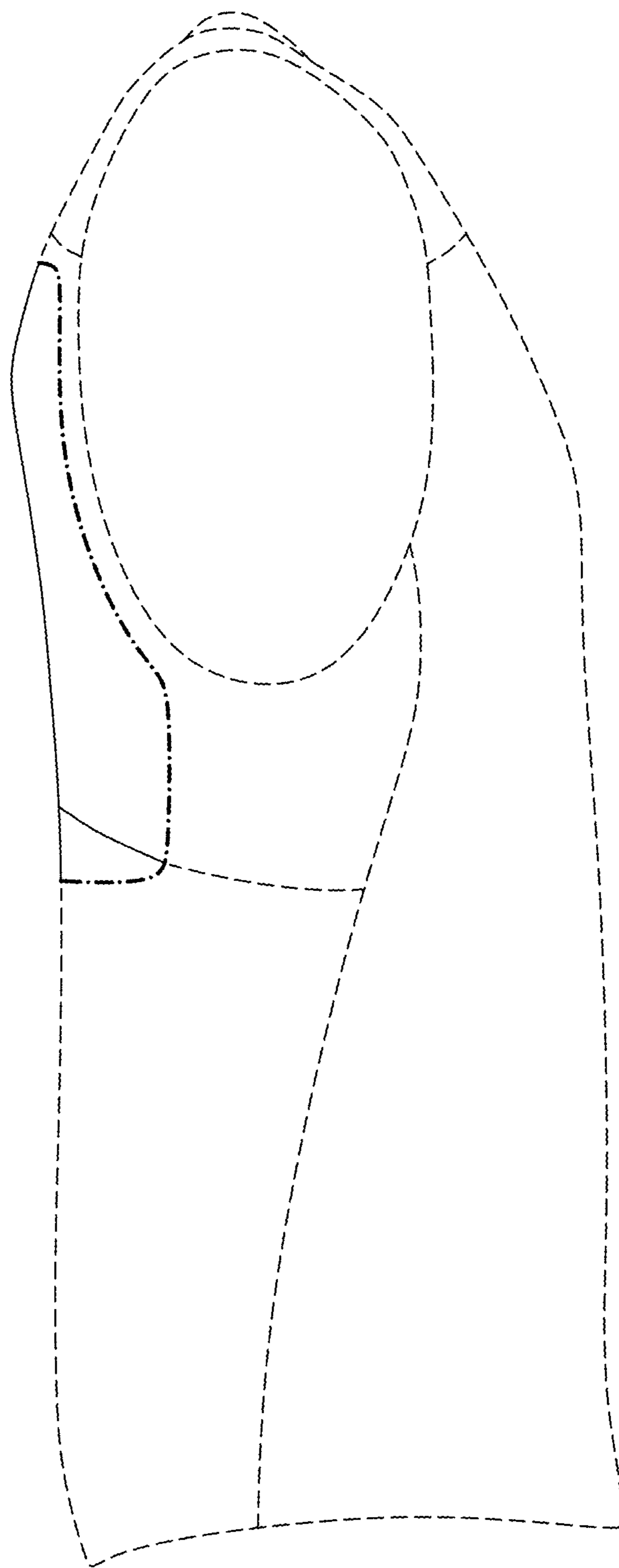
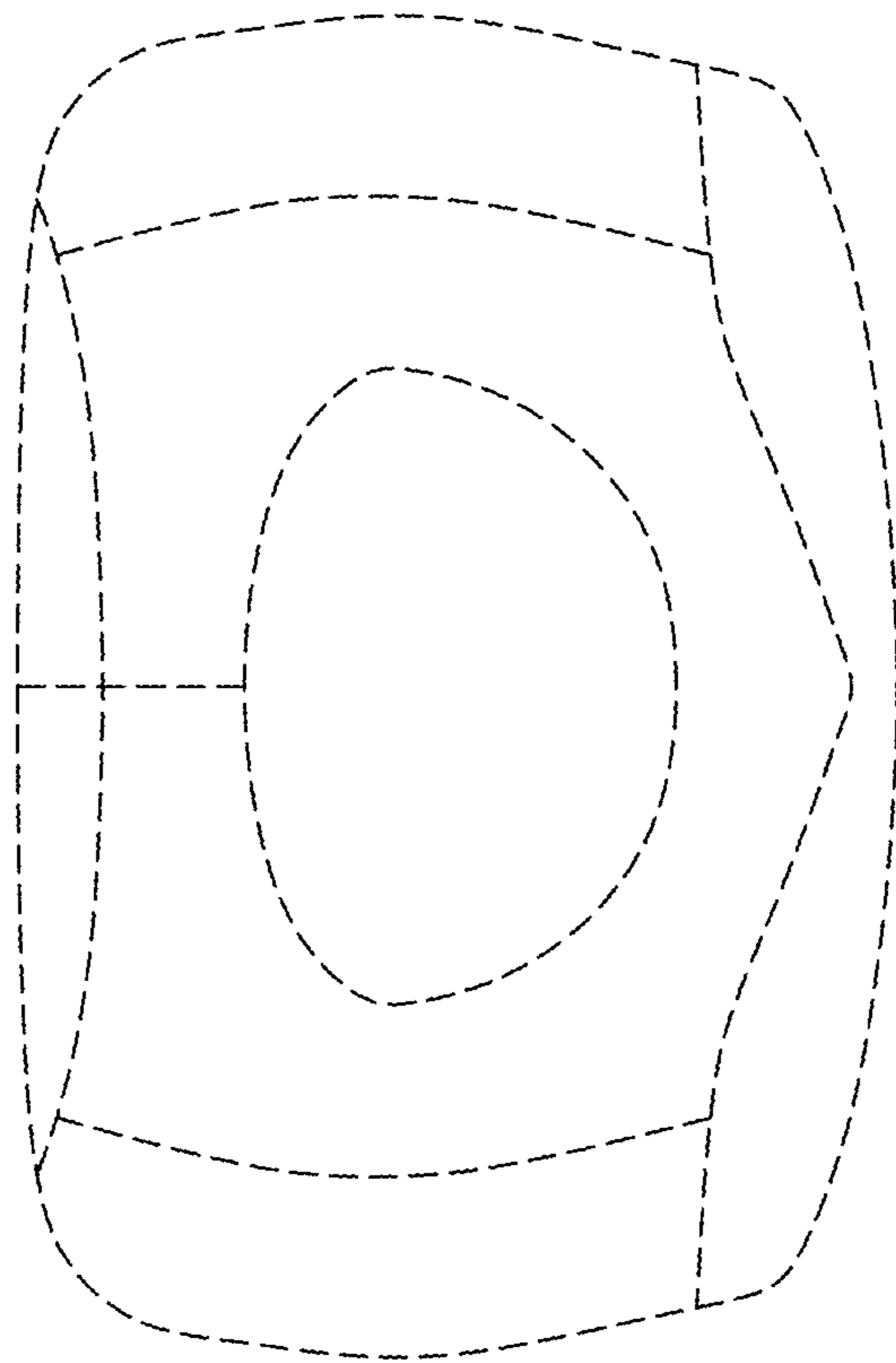

FIG. 3

FIG. 4



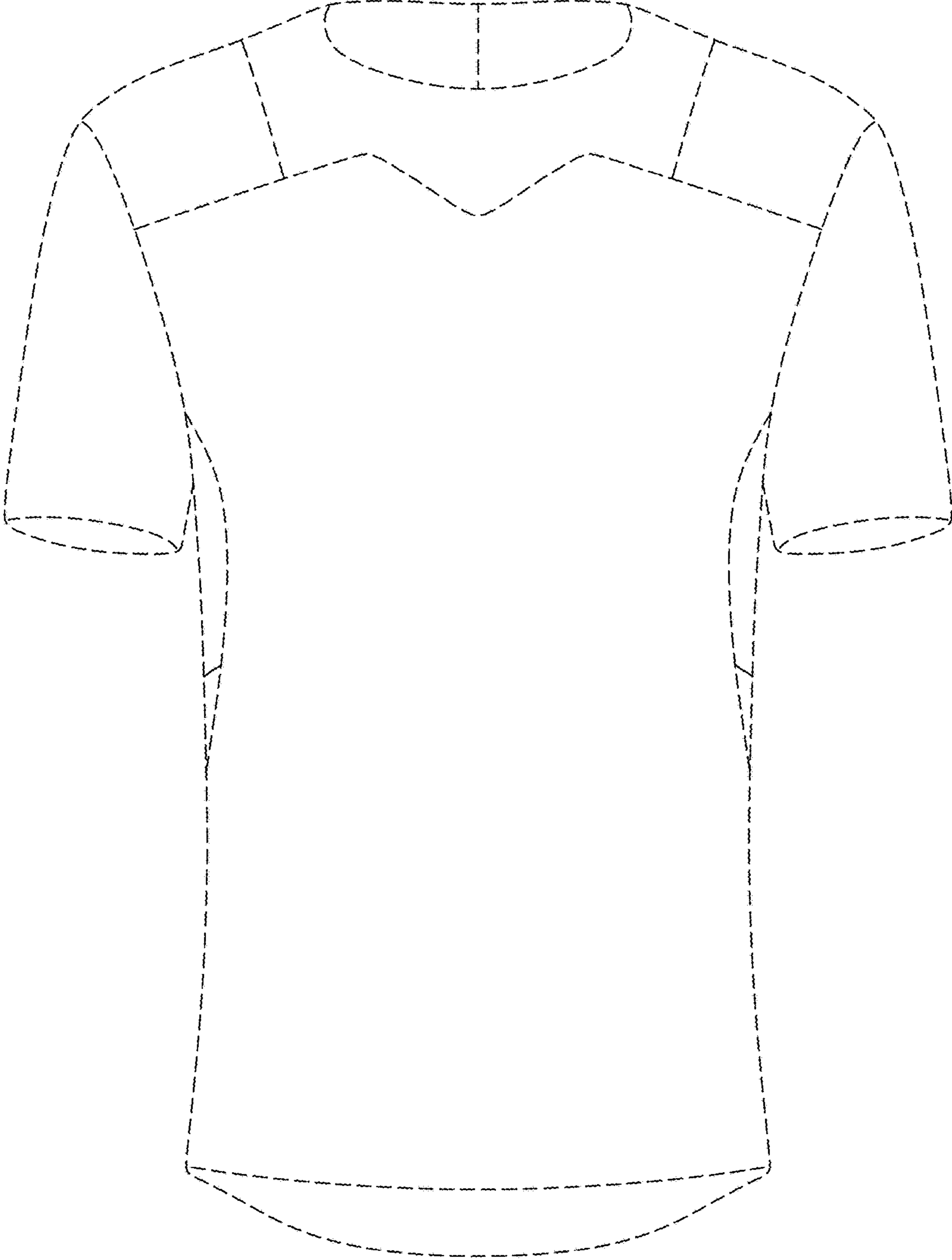

FIG. 5

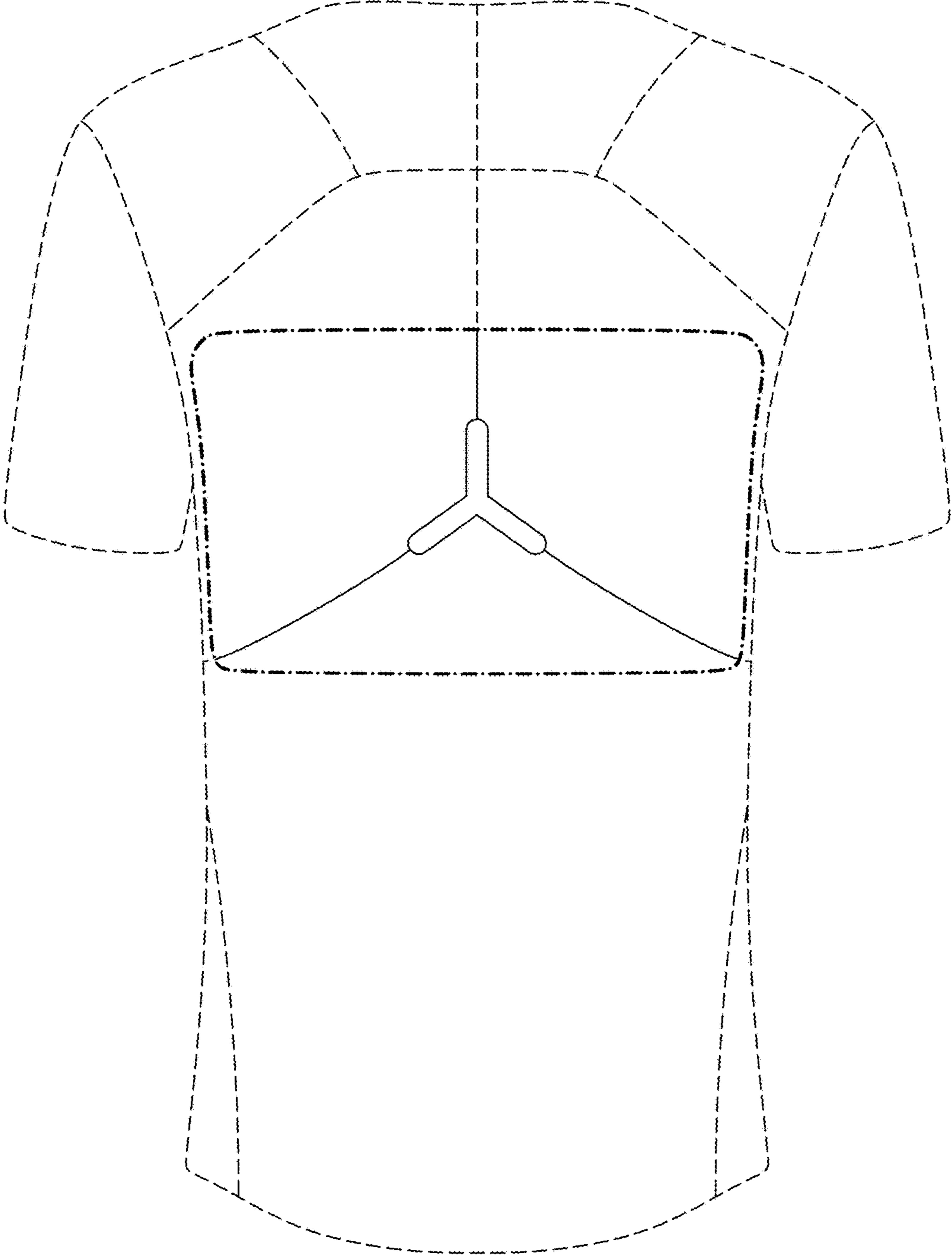

FIG. 6

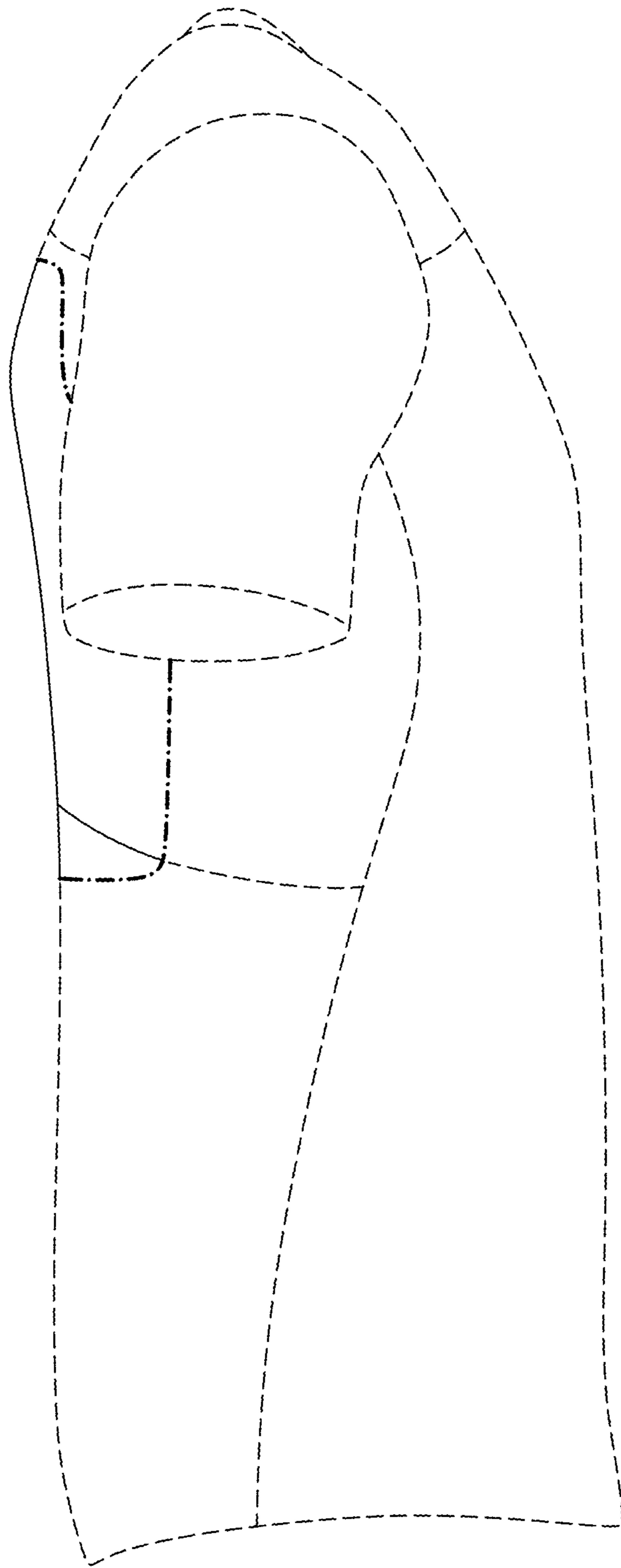
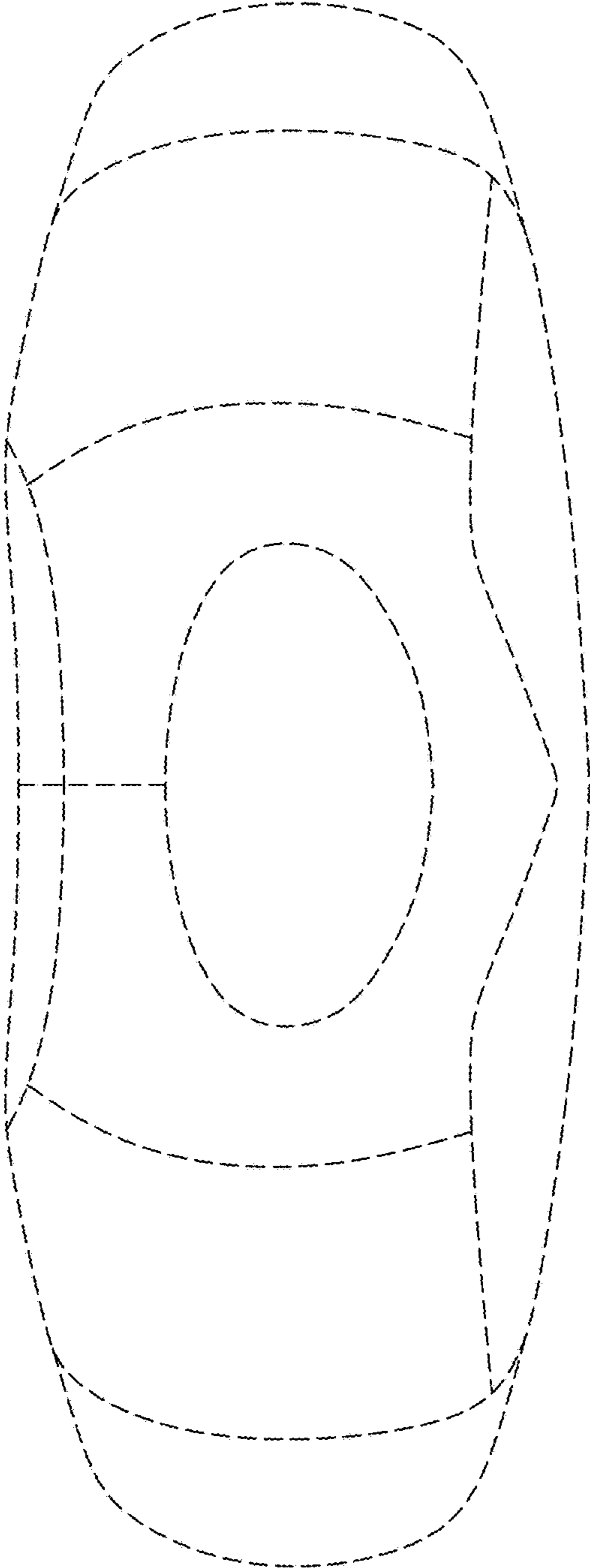

FIG. 7

FIG. 8



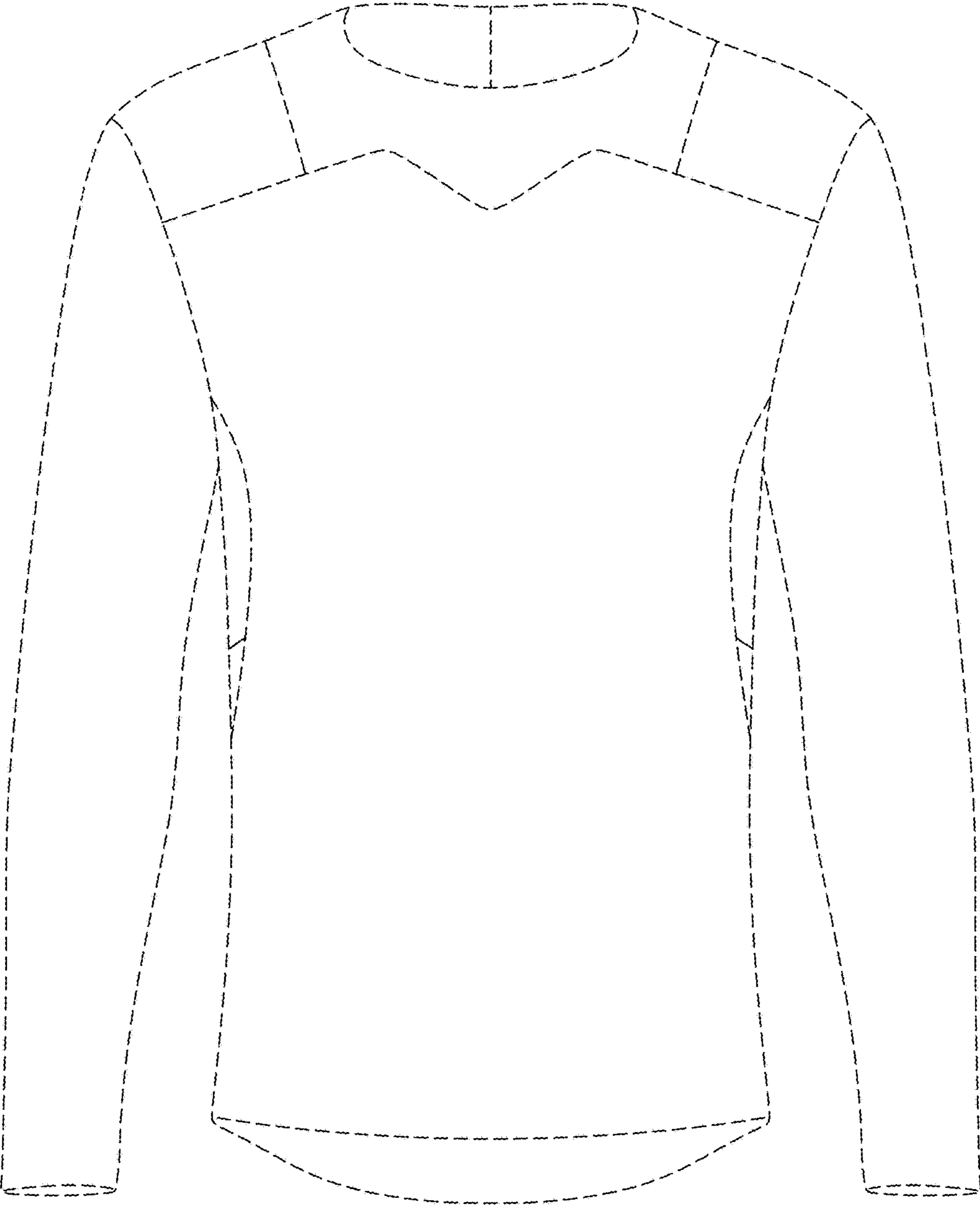

FIG. 9

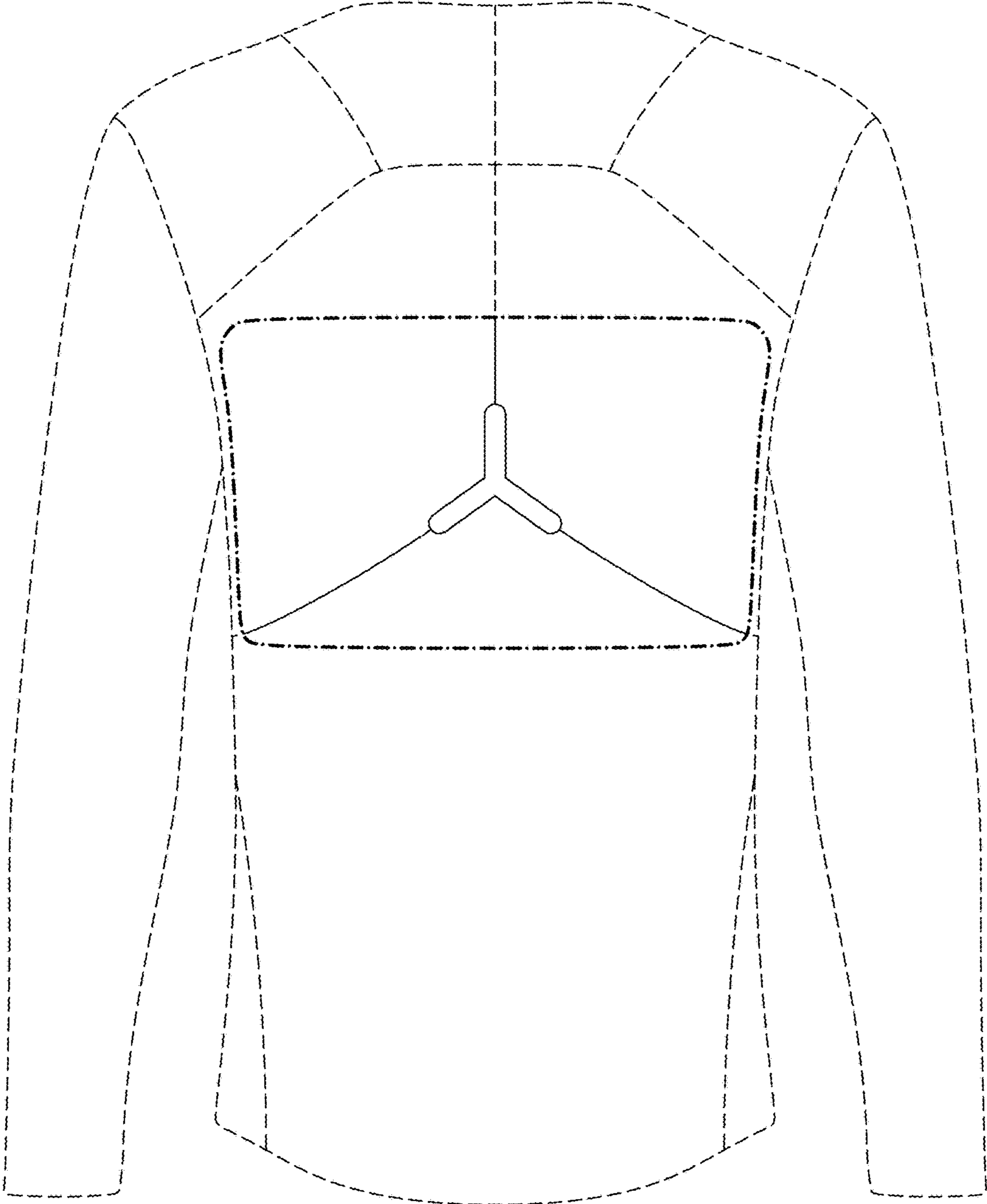

FIG. 10

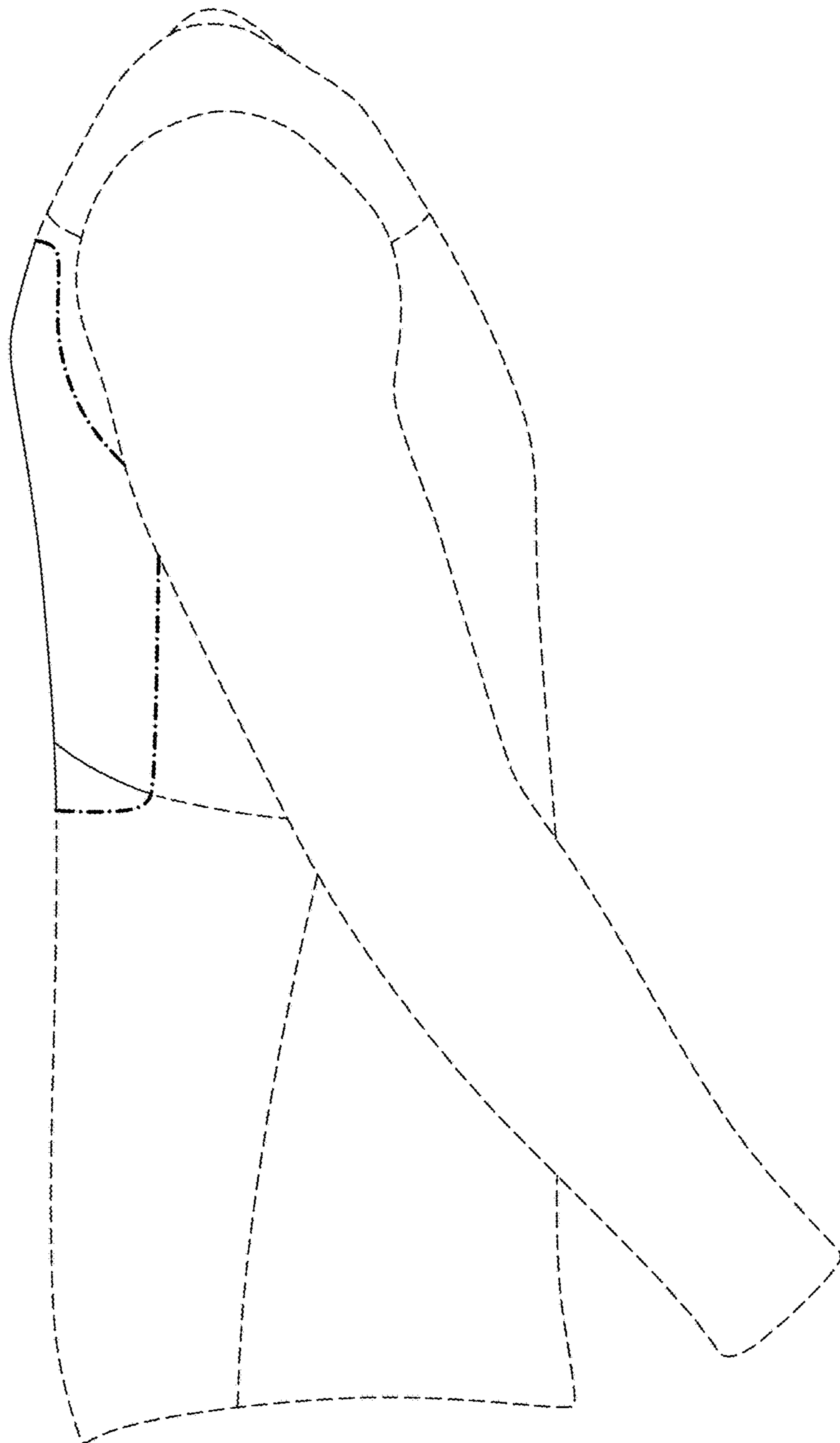
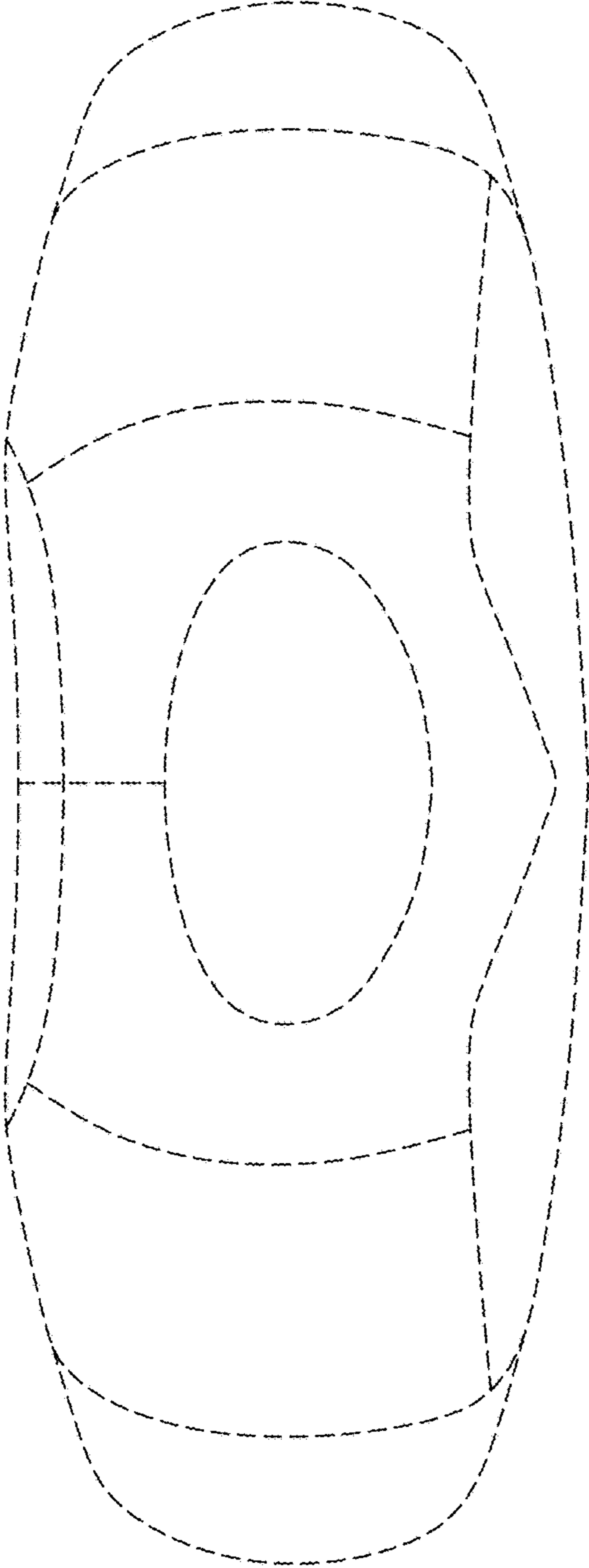

FIG. 11

FIG. 12



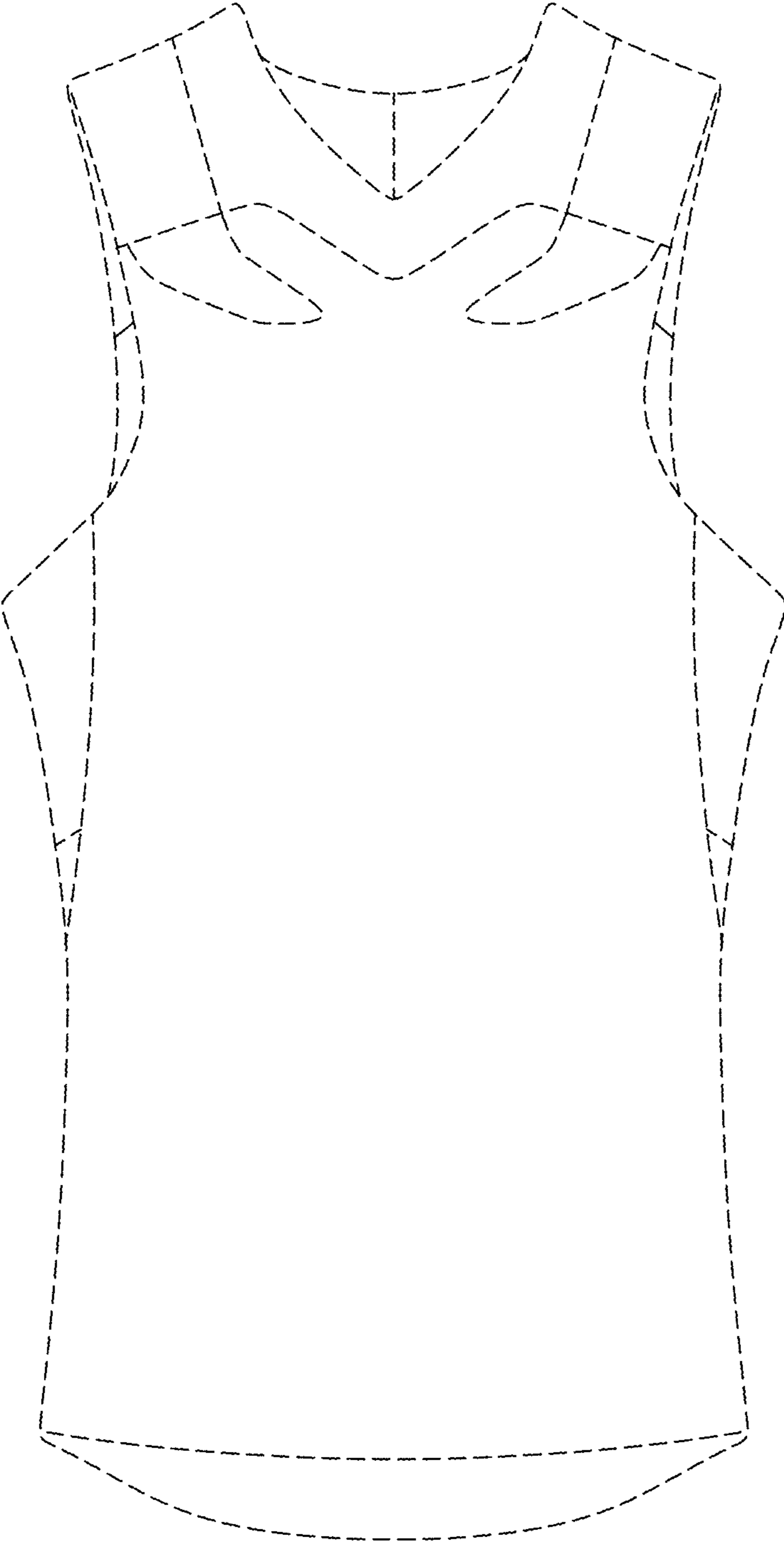

FIG. 13

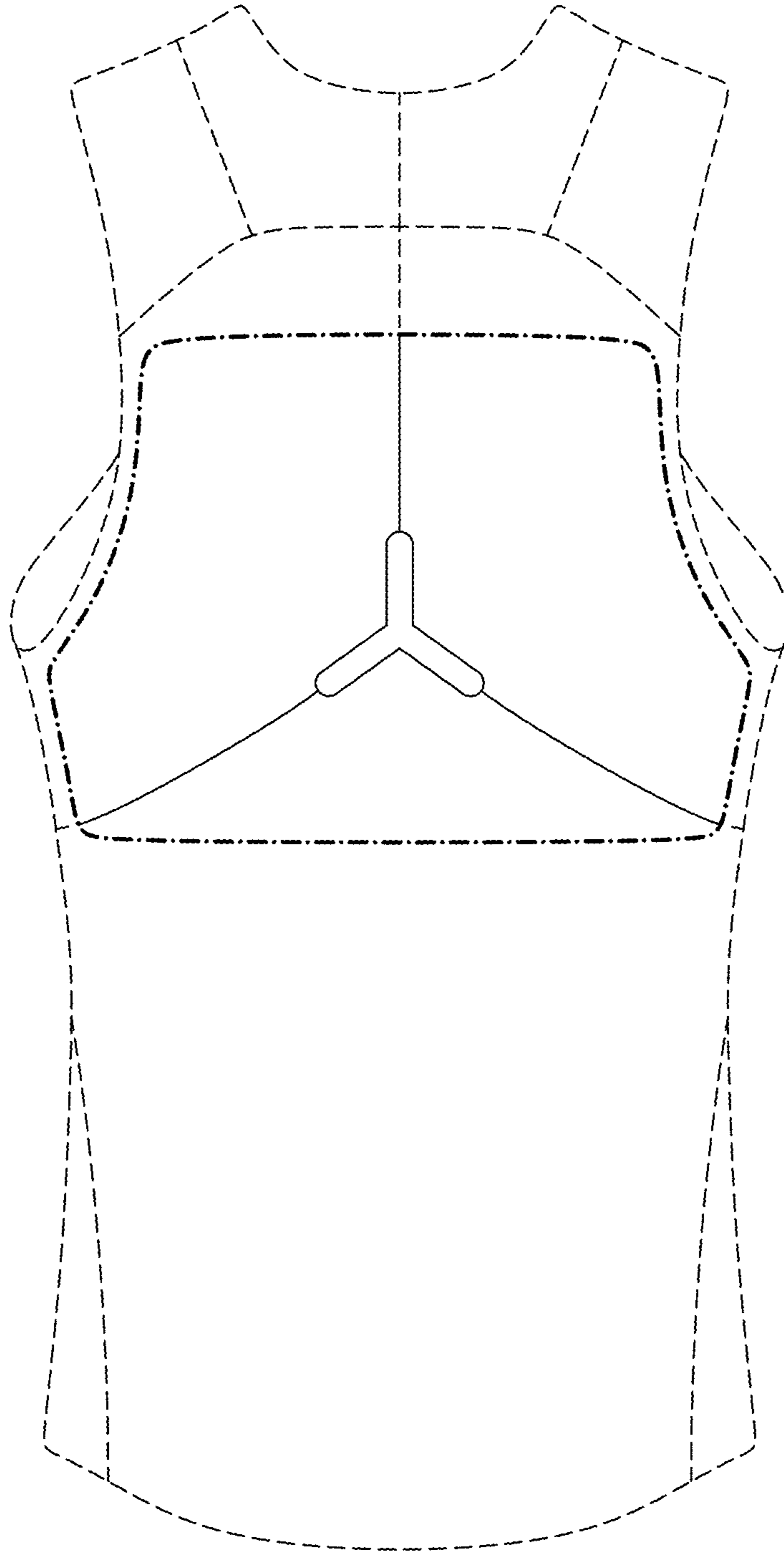

FIG. 14

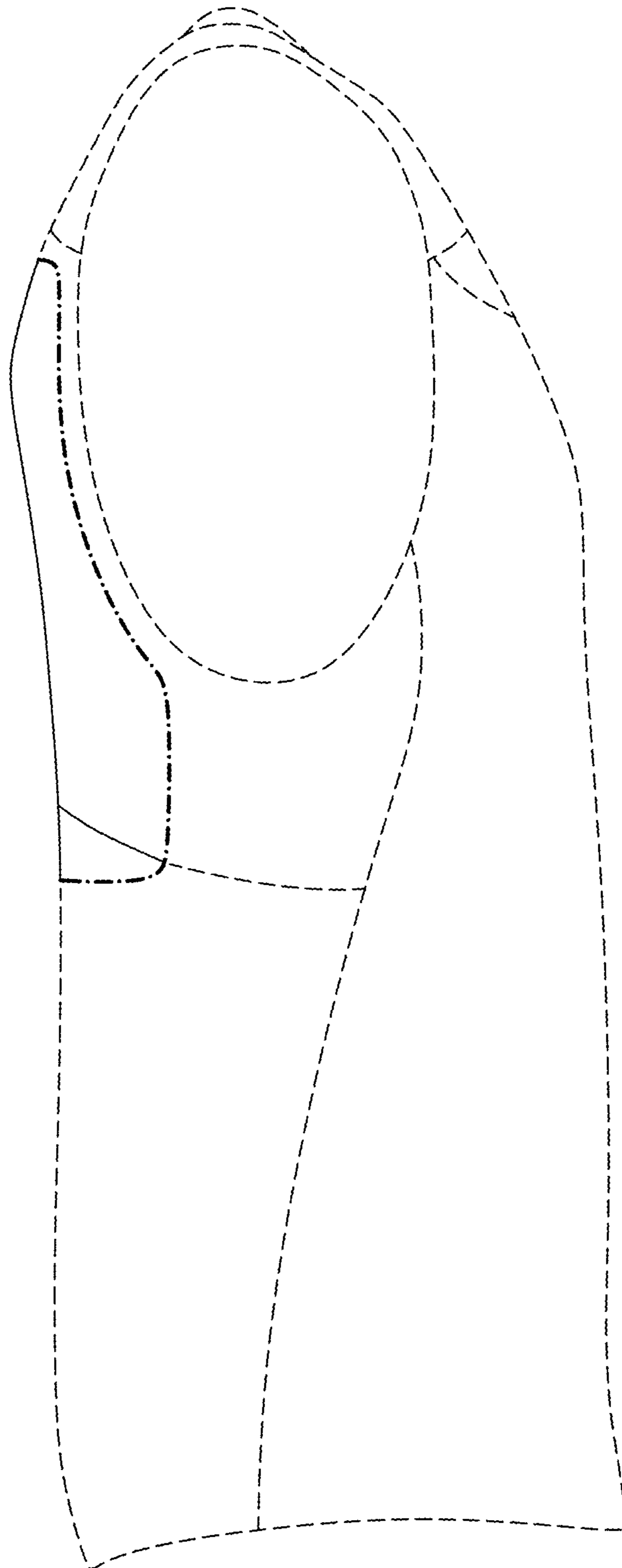
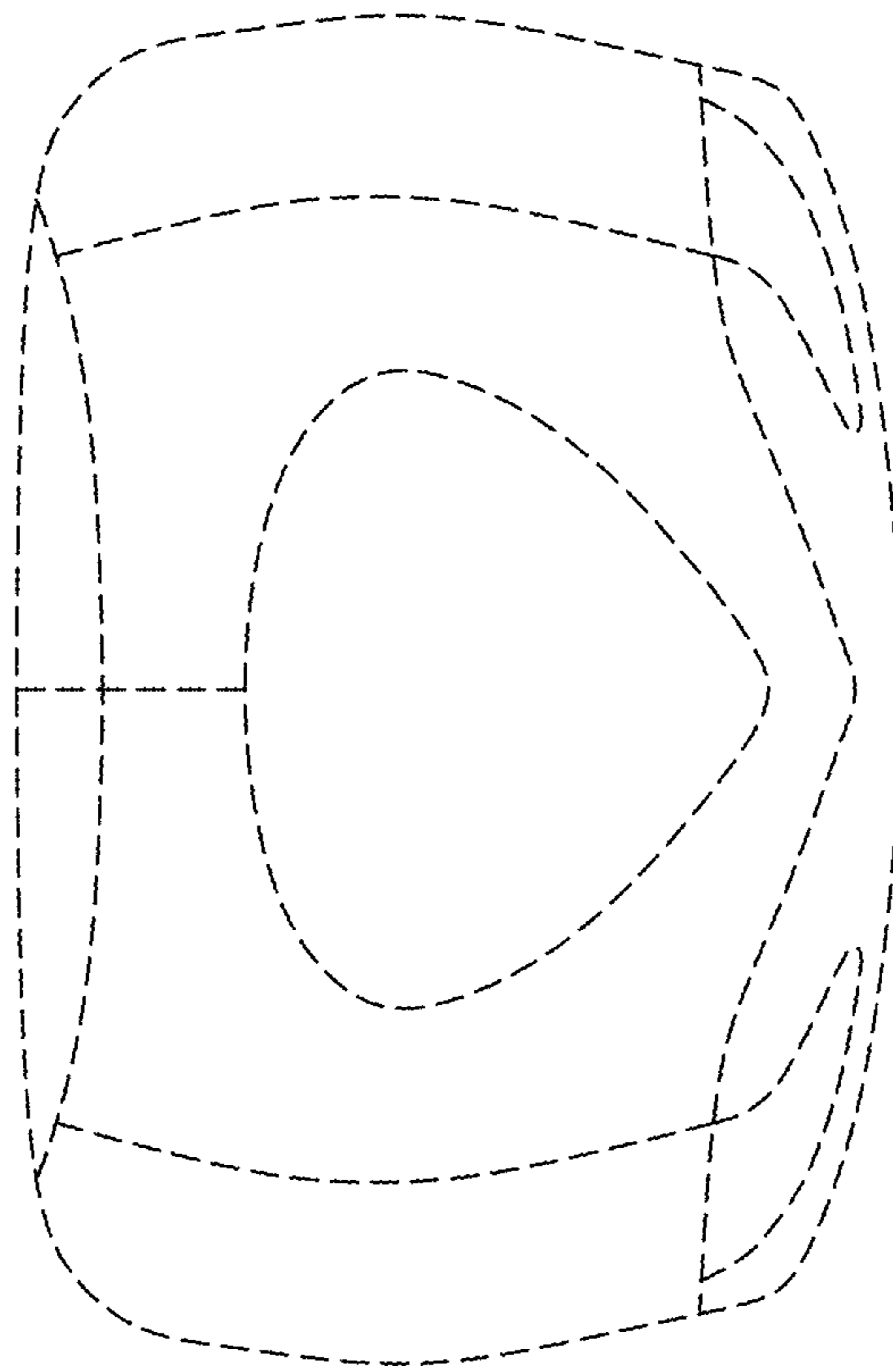

FIG. 15

FIG. 16



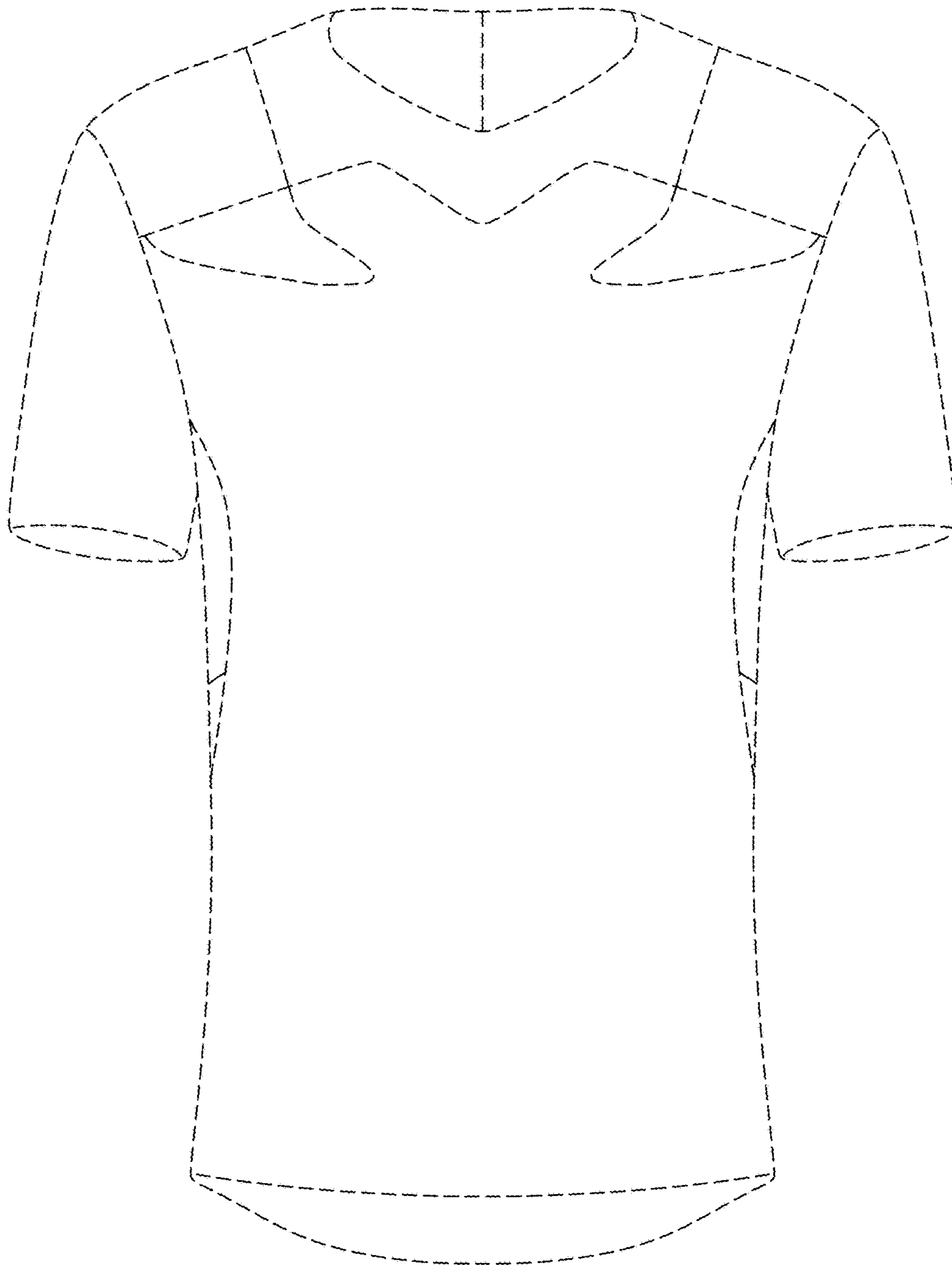

FIG. 17

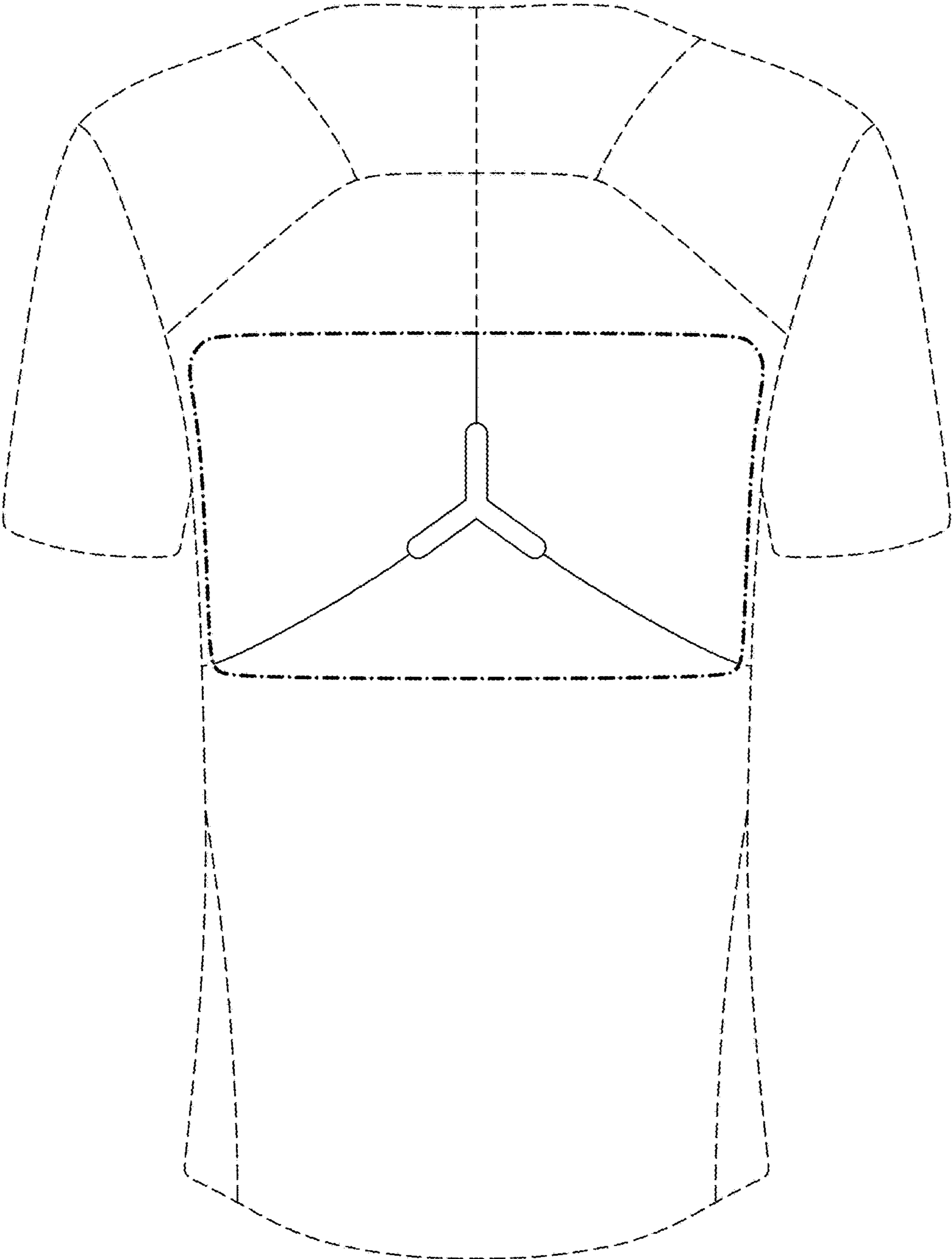

FIG. 18

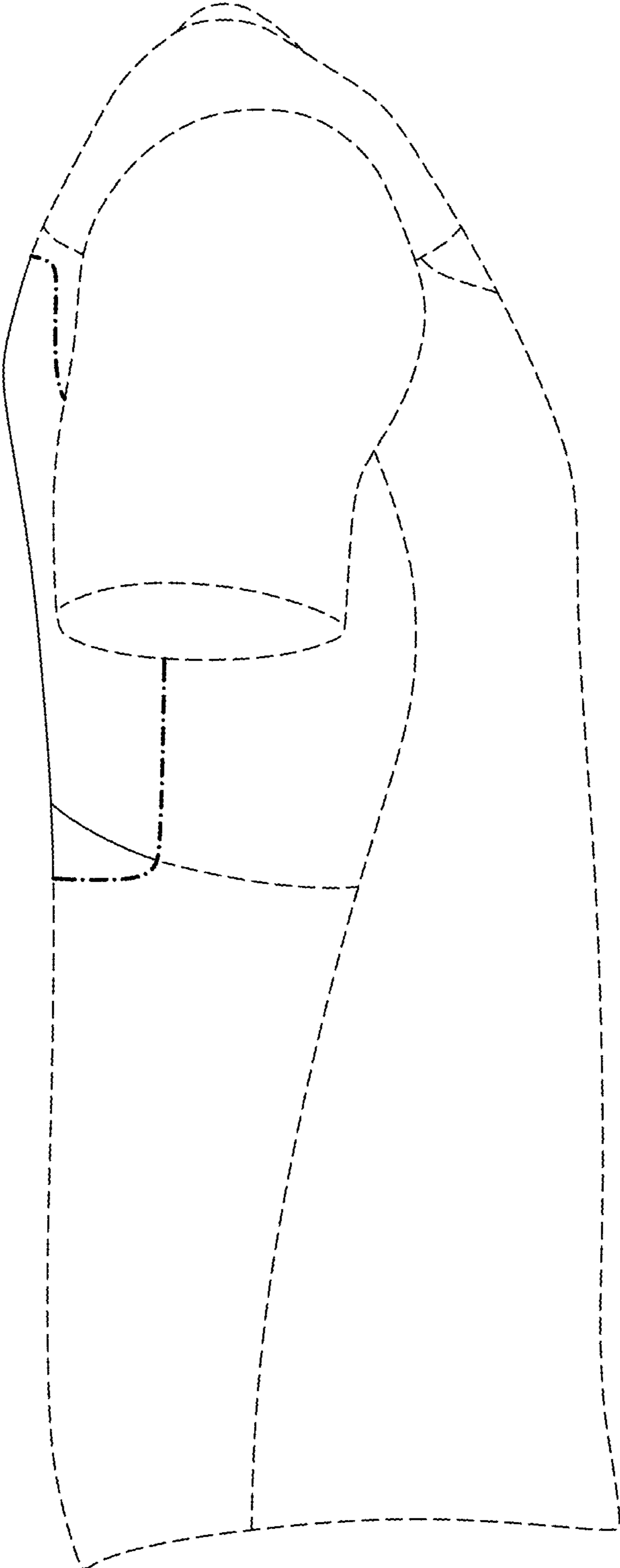
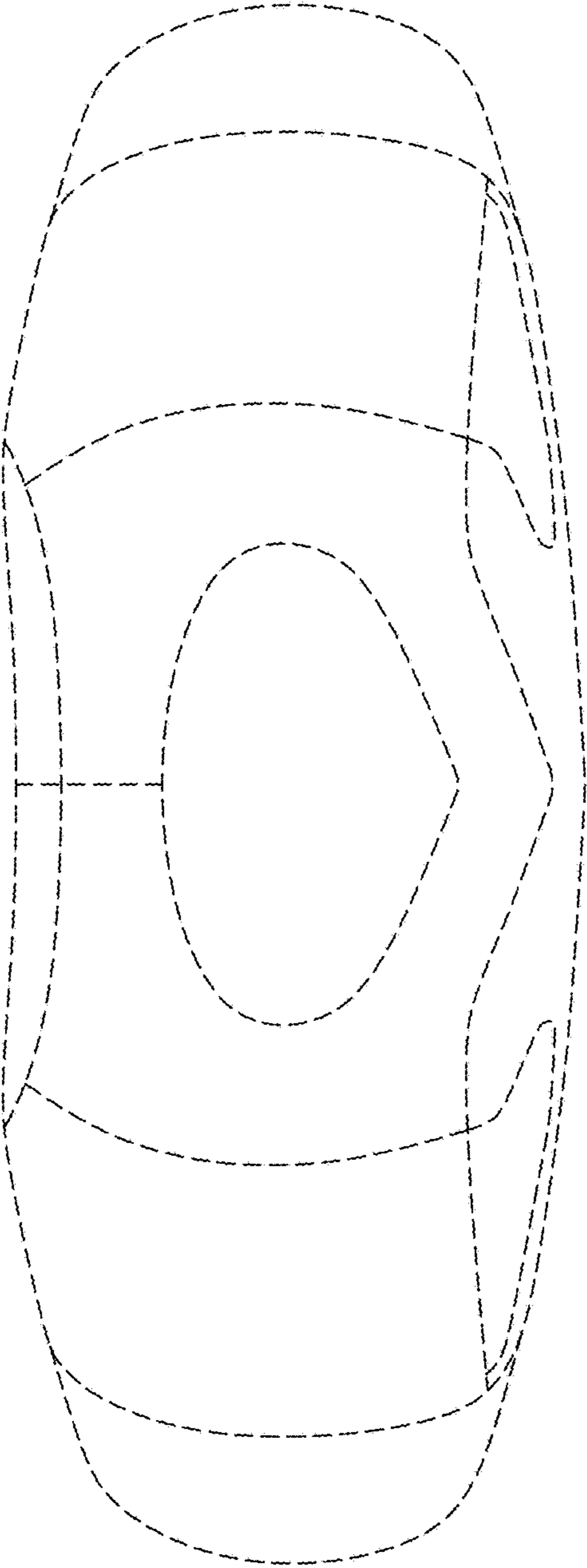

FIG. 19

FIG. 20



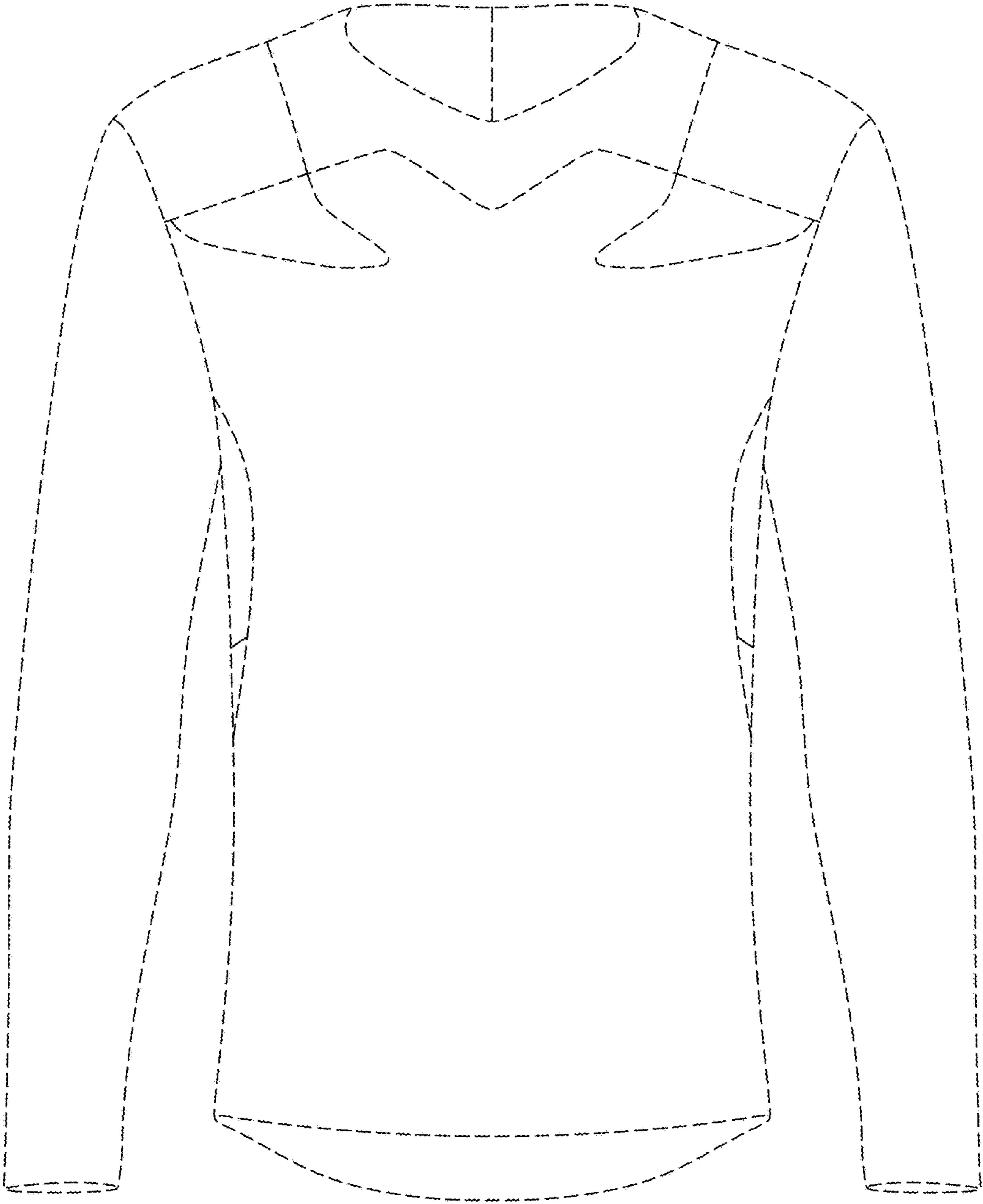

FIG. 21

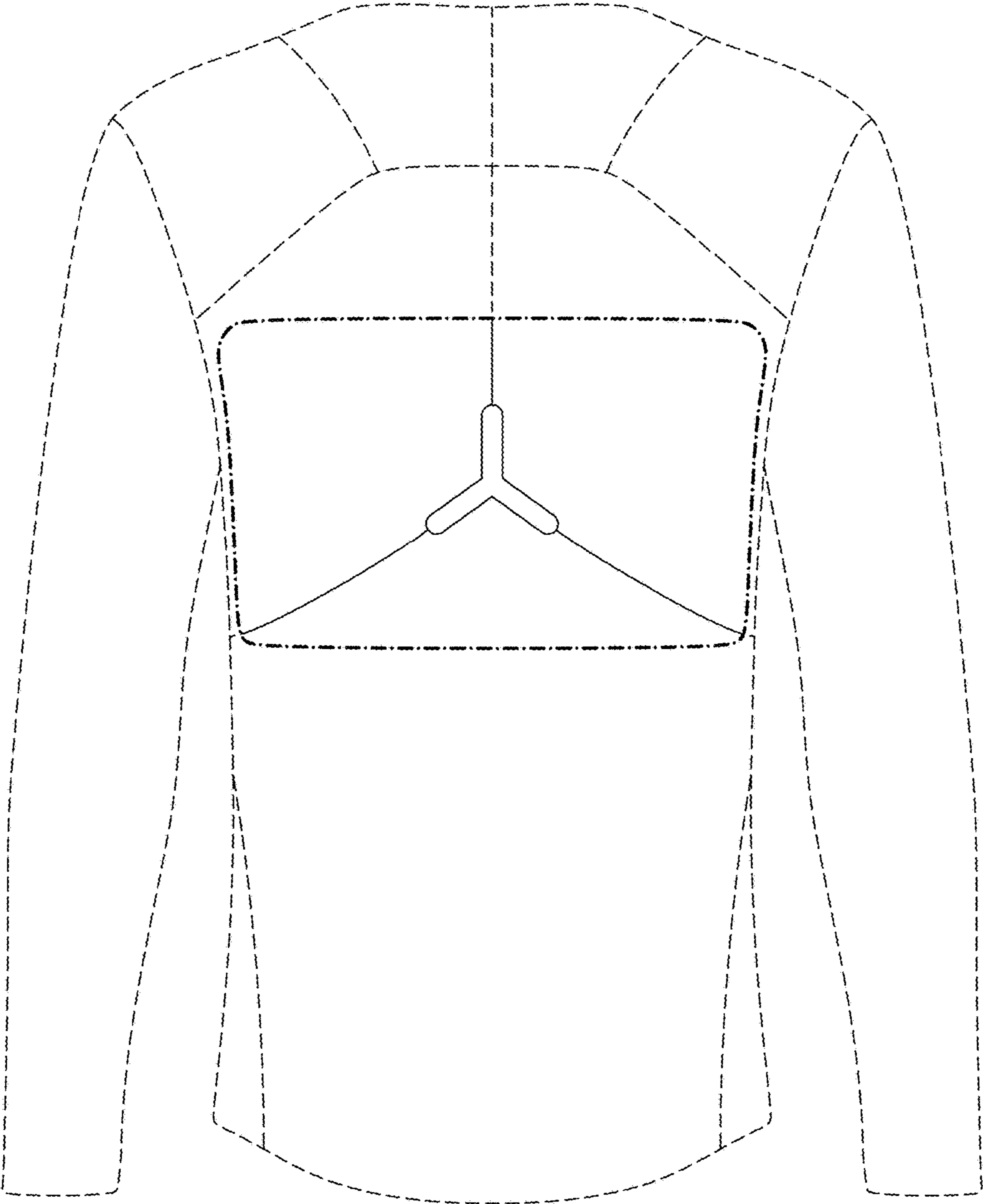

FIG. 22

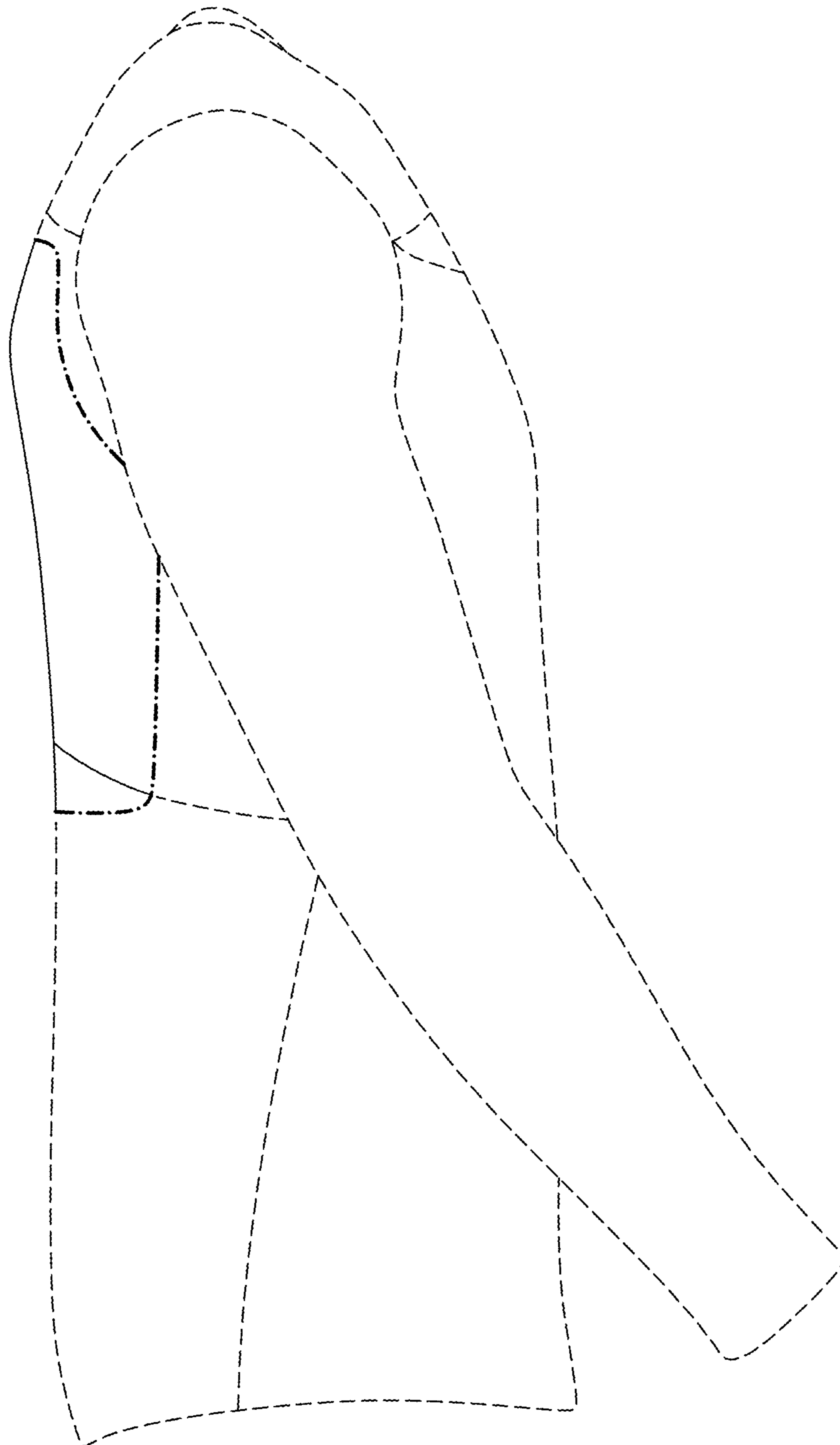
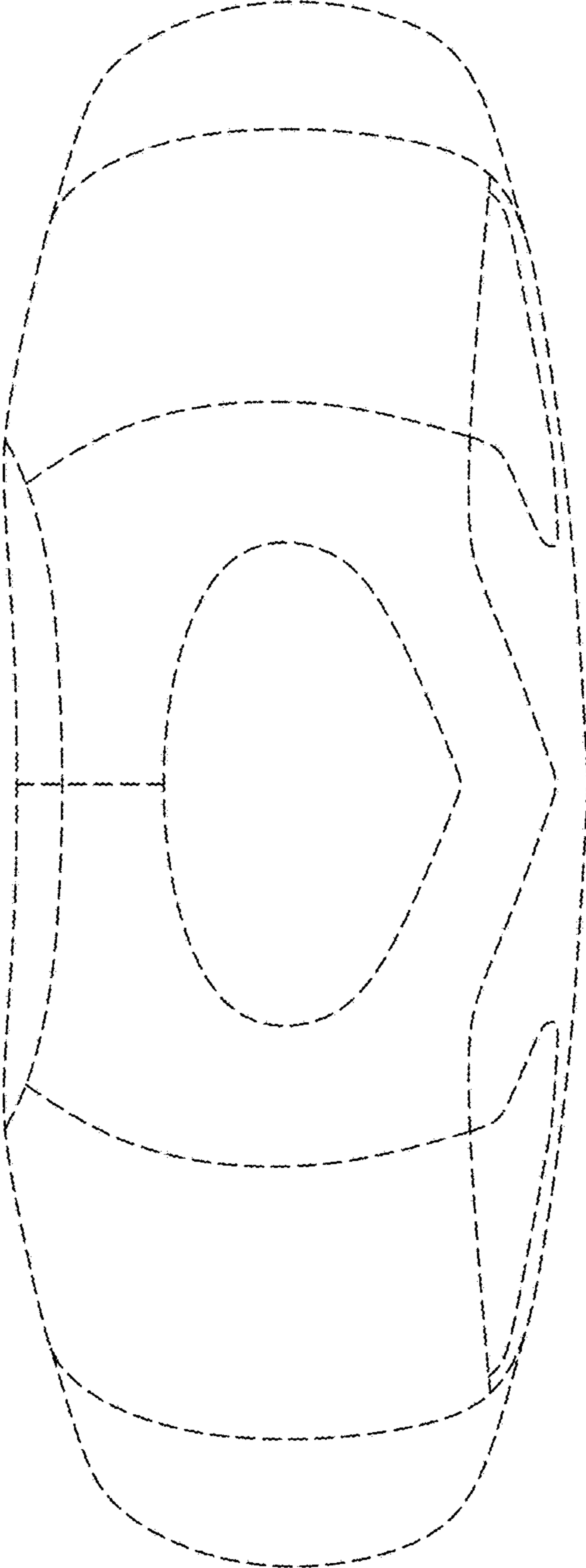

FIG. 23

FIG. 24



UNITED STATES PATENT AND TRADEMARK OFFICE
CERTIFICATE OF CORRECTION

PATENT NO. : D783,932 S
APPLICATION NO. : 29/530055
DATED : April 18, 2017
INVENTOR(S) : Sara Cruthers, David Turner and Jaison Williams

Page 1 of 1

It is certified that error appears in the above-identified patent and that said Letters Patent is hereby corrected as shown below:

In the Description

Line 29: "thereof; and," should read --thereof; and--.

Signed and Sealed this
Eleventh Day of July, 2017



Joseph Matal
*Performing the Functions and Duties of the
Under Secretary of Commerce for Intellectual Property and
Director of the United States Patent and Trademark Office*