



US00D783882S

(12) **United States Design Patent**
Dolan

(10) **Patent No.:** **US D783,882 S**

(45) **Date of Patent:** **** Apr. 11, 2017**

(54) **LIGHT FIXTURE**

(71) Applicant: **Patrick S Dolan**, Portland, OR (US)

(72) Inventor: **Patrick S Dolan**, Portland, OR (US)

(**) Term: **15 Years**

(21) Appl. No.: **29/505,725**

(22) Filed: **Jan. 19, 2016**

(51) **LOC (10) Cl.** **26-03**

(52) **U.S. Cl.**
USPC **D26/87**

(58) **Field of Classification Search**
USPC D26/72, 85, 86, 87, 118, 120, 141, 145,
D26/155
CPC F21S 8/03; F21S 8/035; F21S 8/036; F21S
8/037; F21V 1/146; F21V 3/0409; F21V
7/043; F21V 7/05; F21V 7/06
See application file for complete search history.

(56) **References Cited**

U.S. PATENT DOCUMENTS

D164,507 S *	9/1951	McCann	D26/76
D261,685 S *	11/1981	Kvasnicka	D26/73
D408,938 S *	4/1999	Miyatake	D26/87
D448,881 S *	10/2001	Lin	D26/155
D465,298 S *	11/2002	Gottwald	D26/85
D539,962 S *	4/2007	Hsu	D26/81
D564,693 S *	3/2008	Ziliani	D26/85
D605,331 S *	12/2009	Miranda	D26/87

D653,381 S *	1/2012	Jensen	D26/87
D754,905 S *	4/2016	Colombo	D26/85
D754,906 S *	4/2016	Smith	D26/80

OTHER PUBLICATIONS

Westinghouse 6227800 Sylvestre One-Light Interior wall fixture. Found at amazon.com visited Nov. 23, 2016. Item first available at Amazon May 9, 2013.(4 pages).*

Eurofase 19417-028 Marond 1-Light wall sconce. Found at amazon.com, visited Nov. 23, 2016. Item first available at Amazon Mar. 28, 2010. (3 pages).*

Kichler Lighting Catalog K114—2014, p. 528, Model 10402 N1.

* cited by examiner

Primary Examiner — Clare E Hefflin

(57) **CLAIM**

The ornamental design for a light fixture, as shown and described.

DESCRIPTION

FIG. 1 is a front elevation view of a light fixture showing the new design;

FIG. 2 is a side elevation view thereof, the opposite side being a mirror image of that shown;

FIG. 3 is a top plan view thereof;

FIG. 4 is a bottom plan view thereof; and,

FIG. 5 is a perspective view thereof.

The broken lines in the drawing depict parts of the light fixture that form no part of the claimed design.

1 Claim, 5 Drawing Sheets

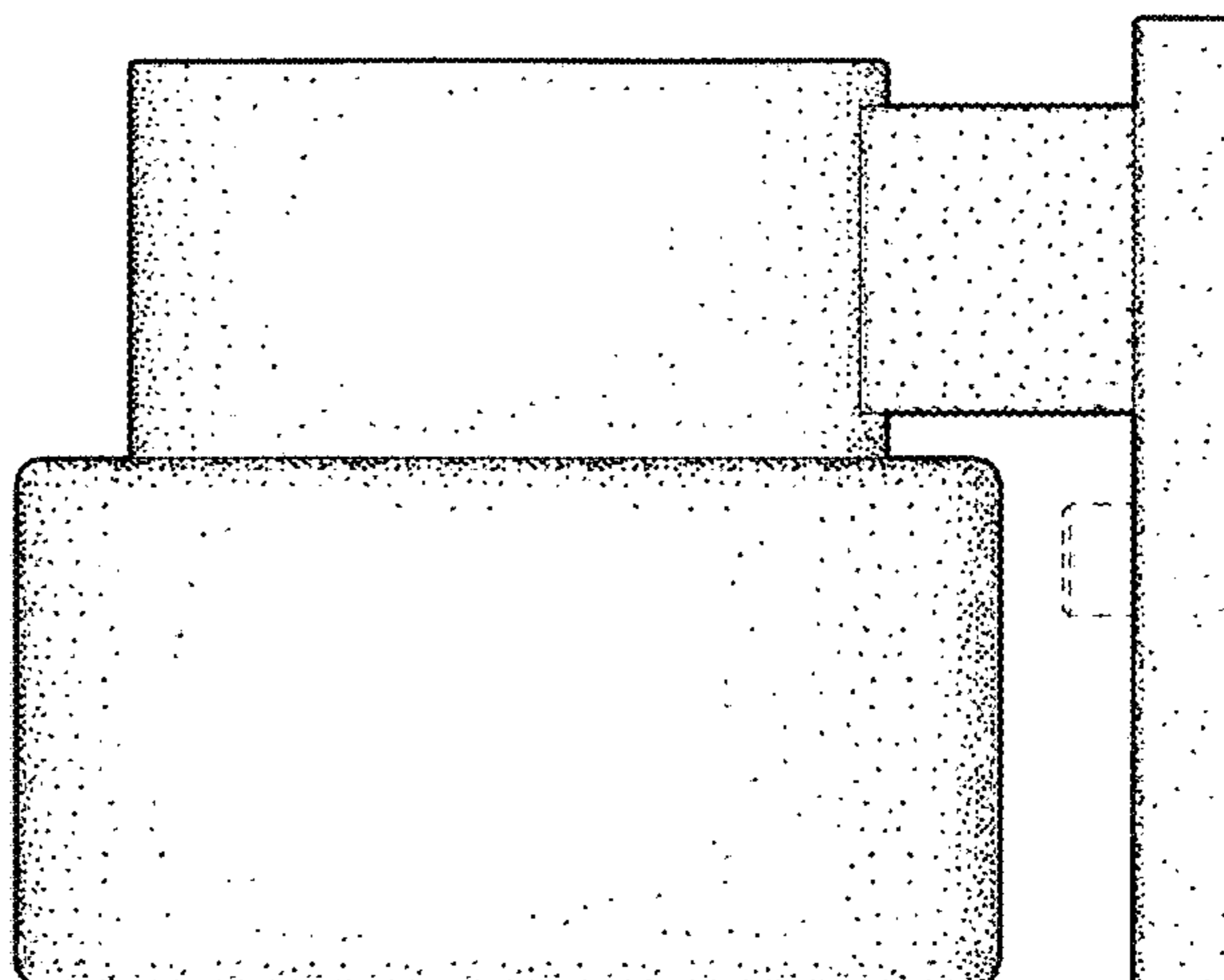
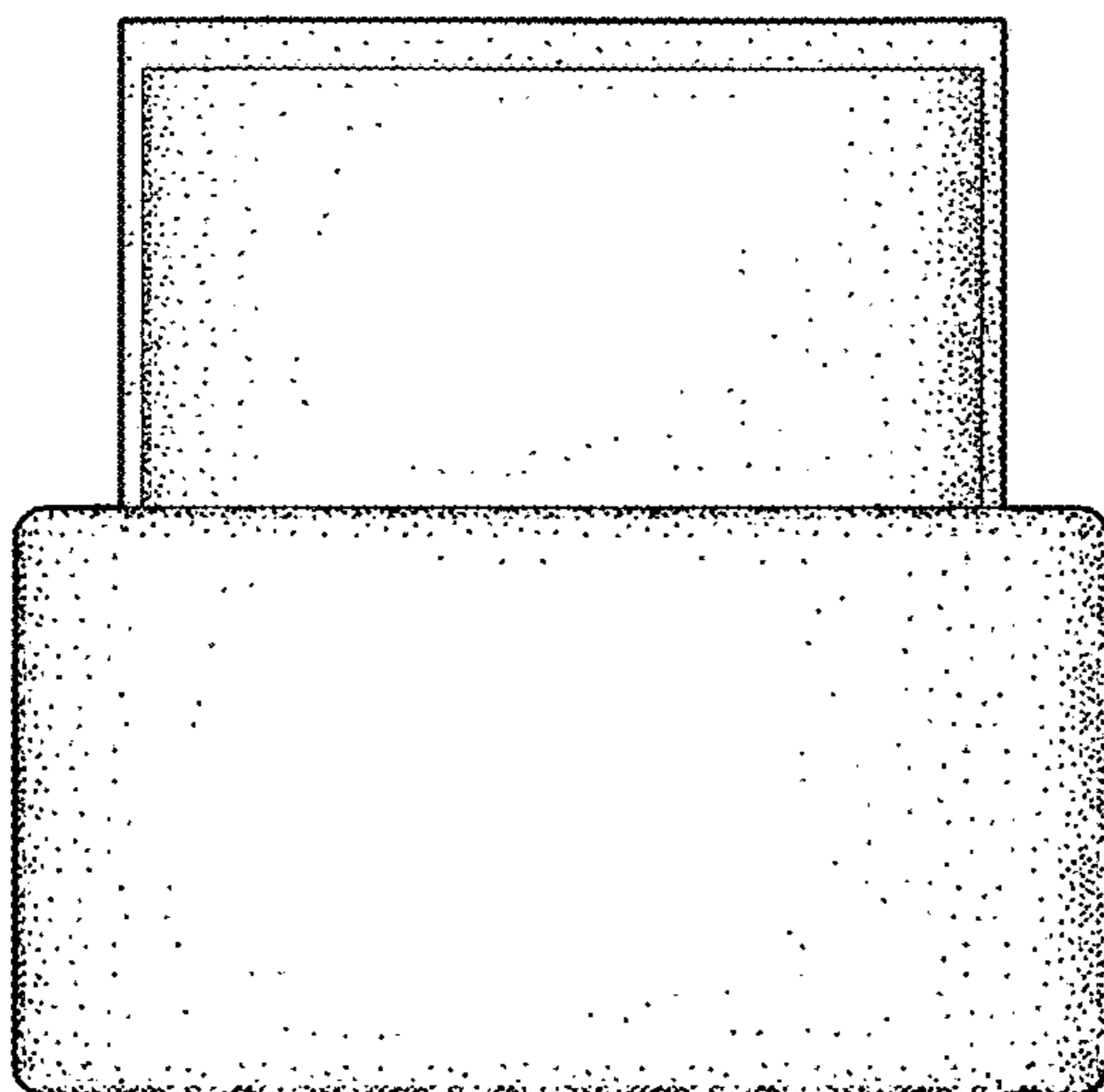

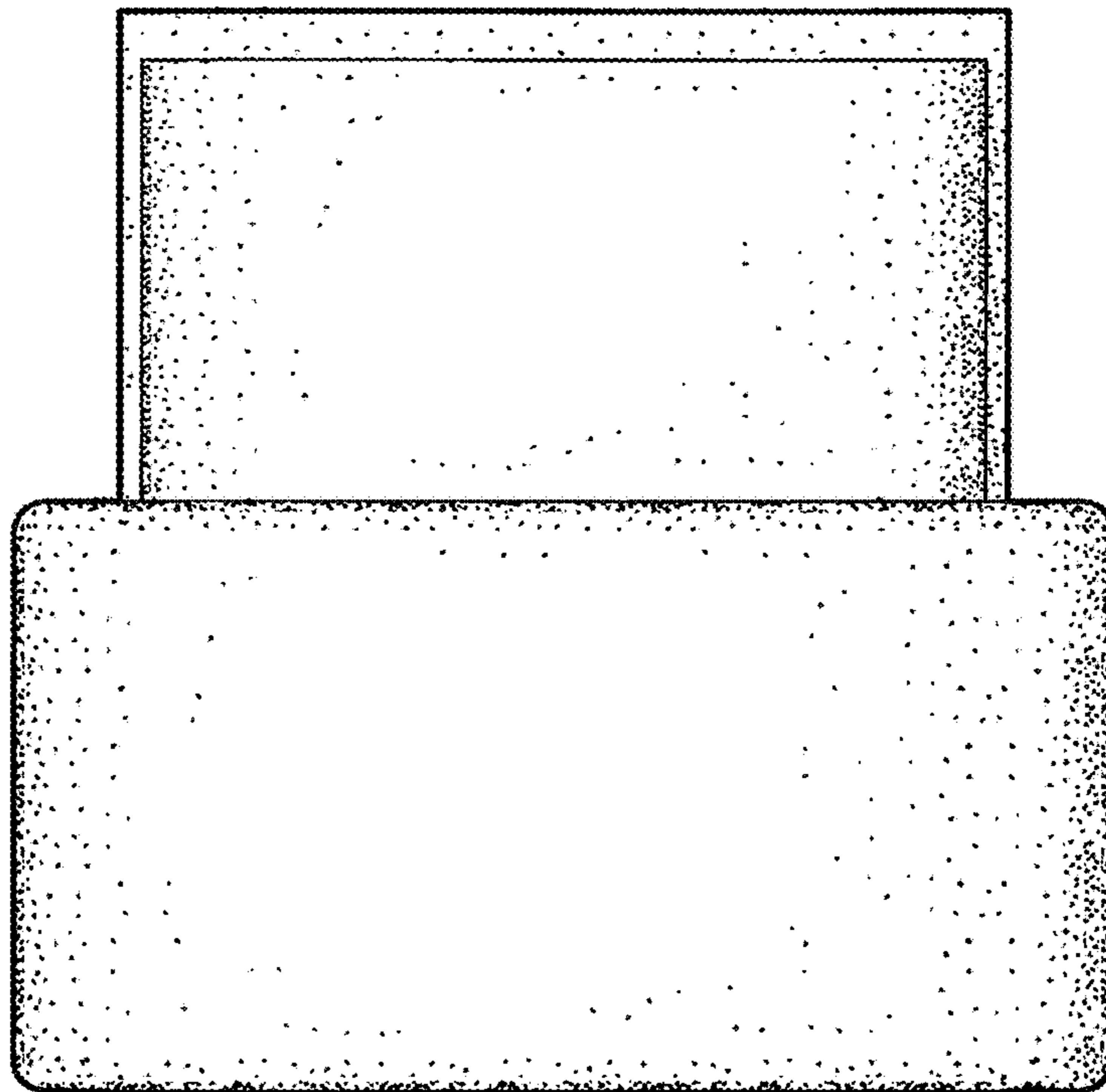

FIG. 1

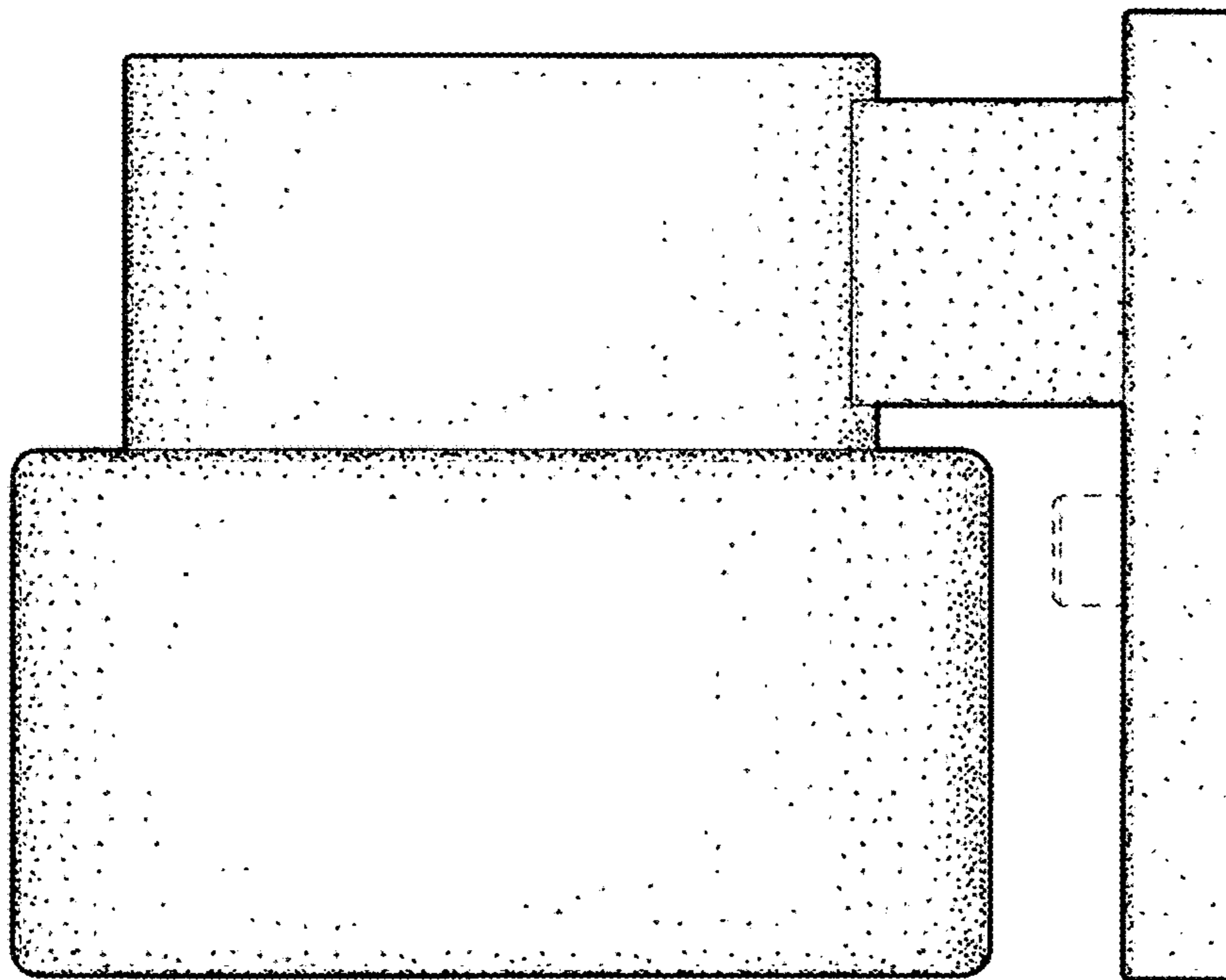

FIG. 2

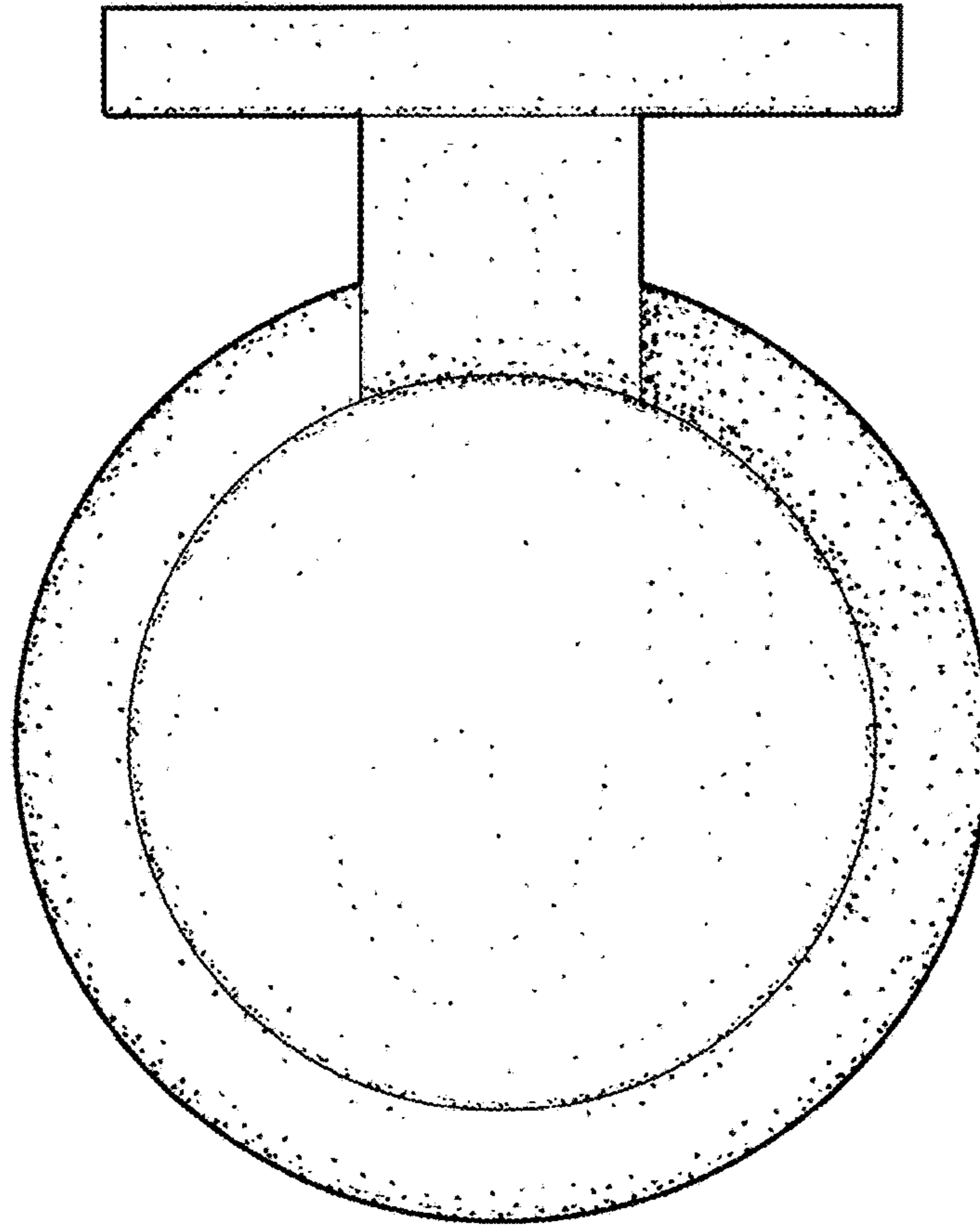

FIG. 3

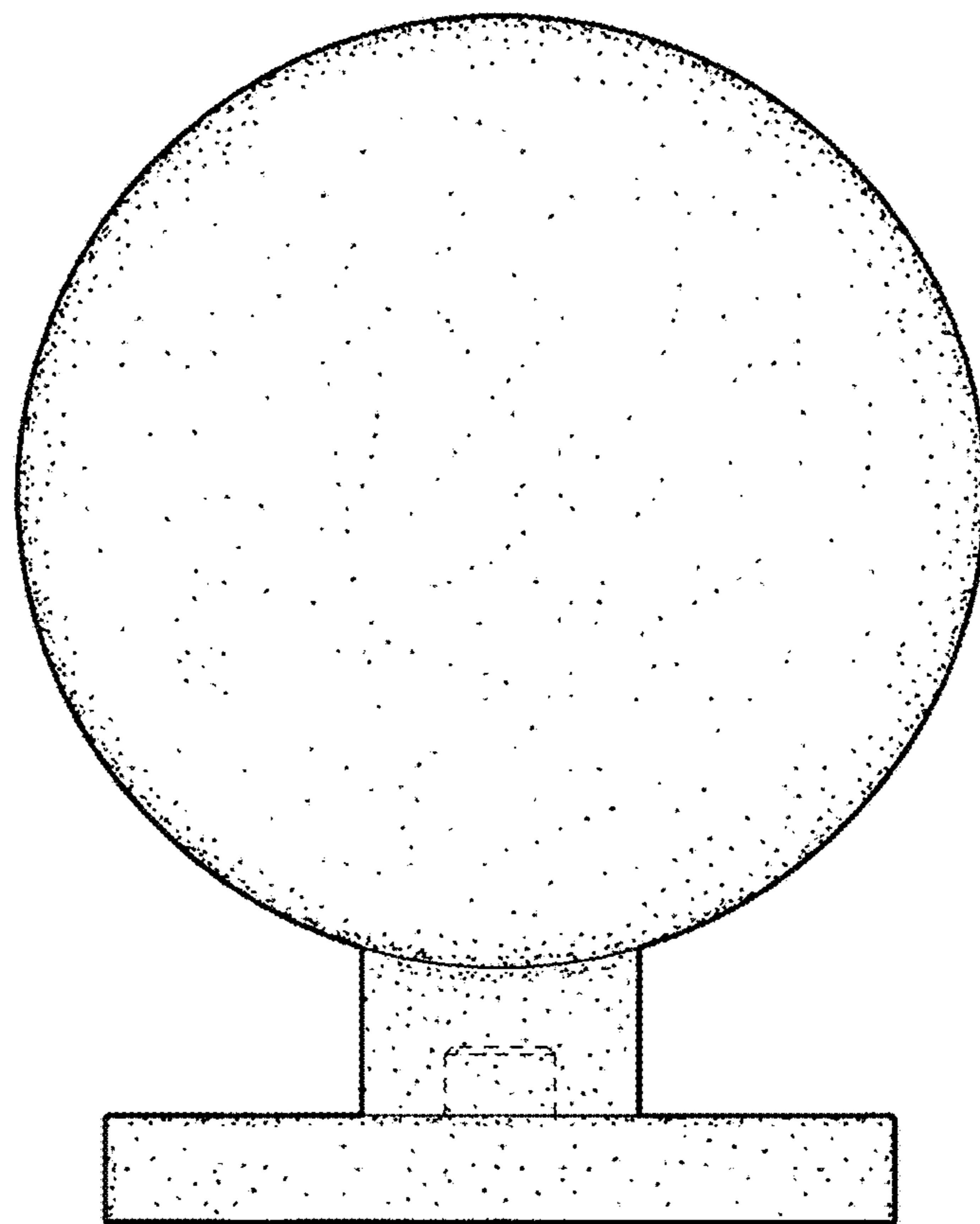

FIG. 4

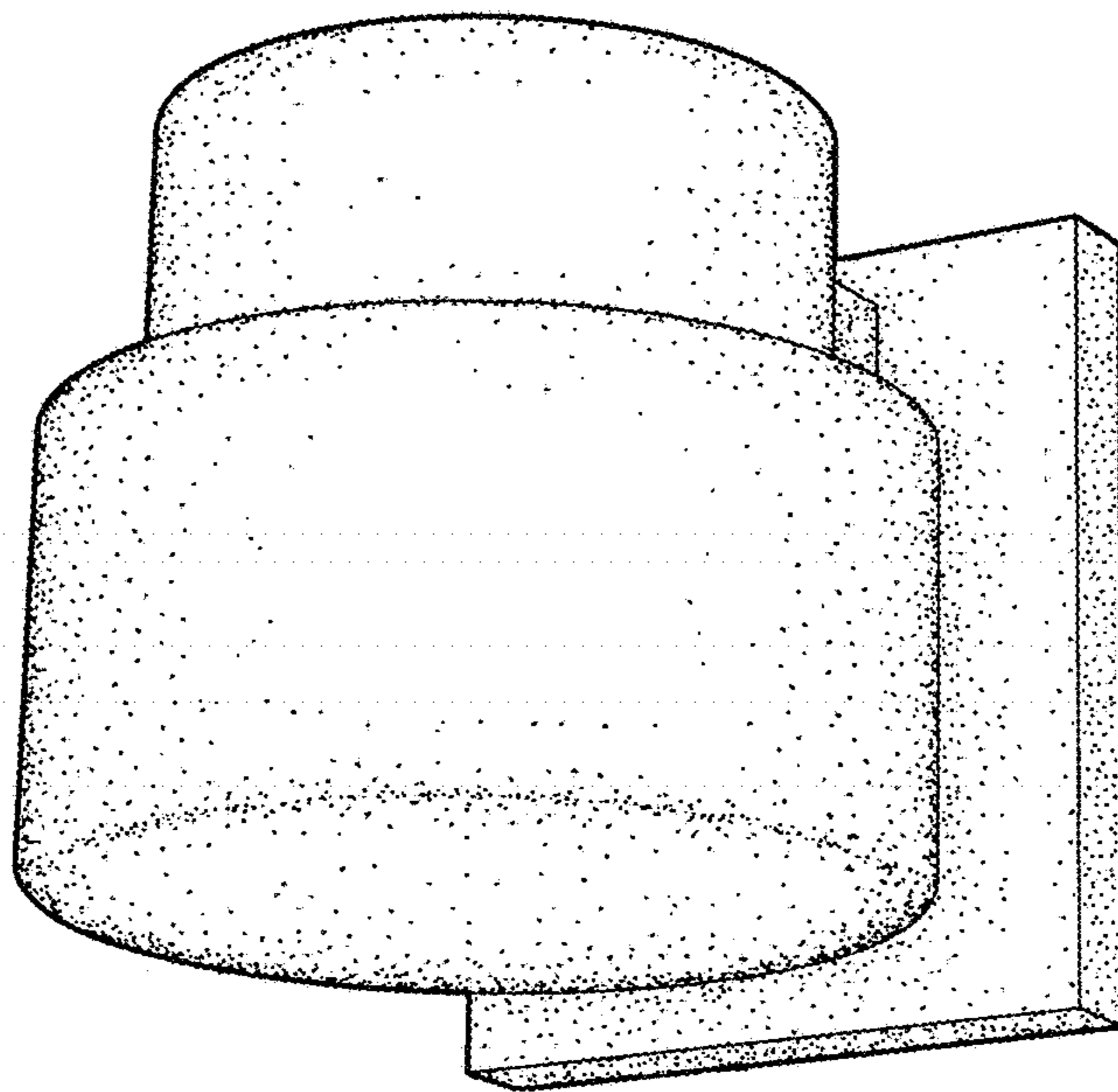

FIG. 5