



US00D783812S

(12) **United States Design Patent**
Kreuzer

(10) **Patent No.:** **US D783,812 S**
(45) **Date of Patent:** **** Apr. 11, 2017**

(54) **ABSORBENT ARTICLE WITH CHANNELS**

(74) *Attorney, Agent, or Firm* — Wednesday G. Shipp

(71) Applicant: **The Procter & Gamble Company**,
Cincinnati, OH (US)

(57) **CLAIM**

The ornamental design for an absorbent article with channels, as shown and described.

(72) Inventor: **Carsten Heinrich Kreuzer**, Hofheim
(DE)

(73) Assignee: **The Procter & Gamble Company**,
Cincinnati, OH (US)

DESCRIPTION

(**) Term: **14 Years**

(21) Appl. No.: **29/476,221**

(22) Filed: **Dec. 12, 2013**

(51) **LOC (10) Cl.** **24-04**

(52) **U.S. Cl.**
USPC **D24/126**

(58) **Field of Classification Search**
USPC D24/124–126
CPC A61F 13/47218; A61F 13/4704; A61F
13/476; A61F 13/15203; A61F 13/4756;
A61F 13/5616; A61F 13/4758; A61F
13/15; A61F 2013/4706
See application file for complete search history.

FIG. 1 illustrates a perspective view of an embodiment of a channels design disposed on a material, included as part of an absorbent article, being worn, by a wearer, e.g. a child; FIG. 2 illustrates a front view of an embodiment of a channels design disposed on a material, included as part of an absorbent article, being worn, by a wearer, e.g. a child; FIG. 3 illustrates a right side view of an embodiment of a channels design disposed on a material, included as part of an absorbent article, being worn, by a wearer, e.g. a child, and the channels design is obstructed from view; FIG. 4 illustrates a back view of an embodiment of a channels design disposed on a material, included as part of an absorbent article, being worn, by a wearer, e.g. a child; FIG. 5 illustrates a left side view of an embodiment of a channels design disposed on a material, included as part of an absorbent article, being worn, by a wearer, e.g. a child, and the channels design is obstructed from view; and, FIG. 6 illustrates a bottom view of an embodiment of a channels design disposed on a material, included as part of an absorbent article, being worn, by a wearer, e.g. a child. The channels are visually distinct from the surface of the absorbent article upon which they are disposed. In various embodiments, the distinction may be exhibited as printed graphics, grooves, or combinations thereof. The broken lines, including those showing the diaper tabs and ears, are included for the purpose of illustrating environment and forms no part of the claimed design.

(56) **References Cited**

U.S. PATENT DOCUMENTS

2,252,992	A *	8/1941	Steiner	604/378
D332,832	S *	1/1993	Powell	D24/126
D345,014	S *	3/1994	Huffman	D24/126
D383,207	S *	9/1997	Cassell	D24/126
D541,932	S *	5/2007	Lemaire et al.	D24/124

(Continued)

Primary Examiner — Michael A. Pratt
Assistant Examiner — Michelle E Wilson

1 Claim, 6 Drawing Sheets

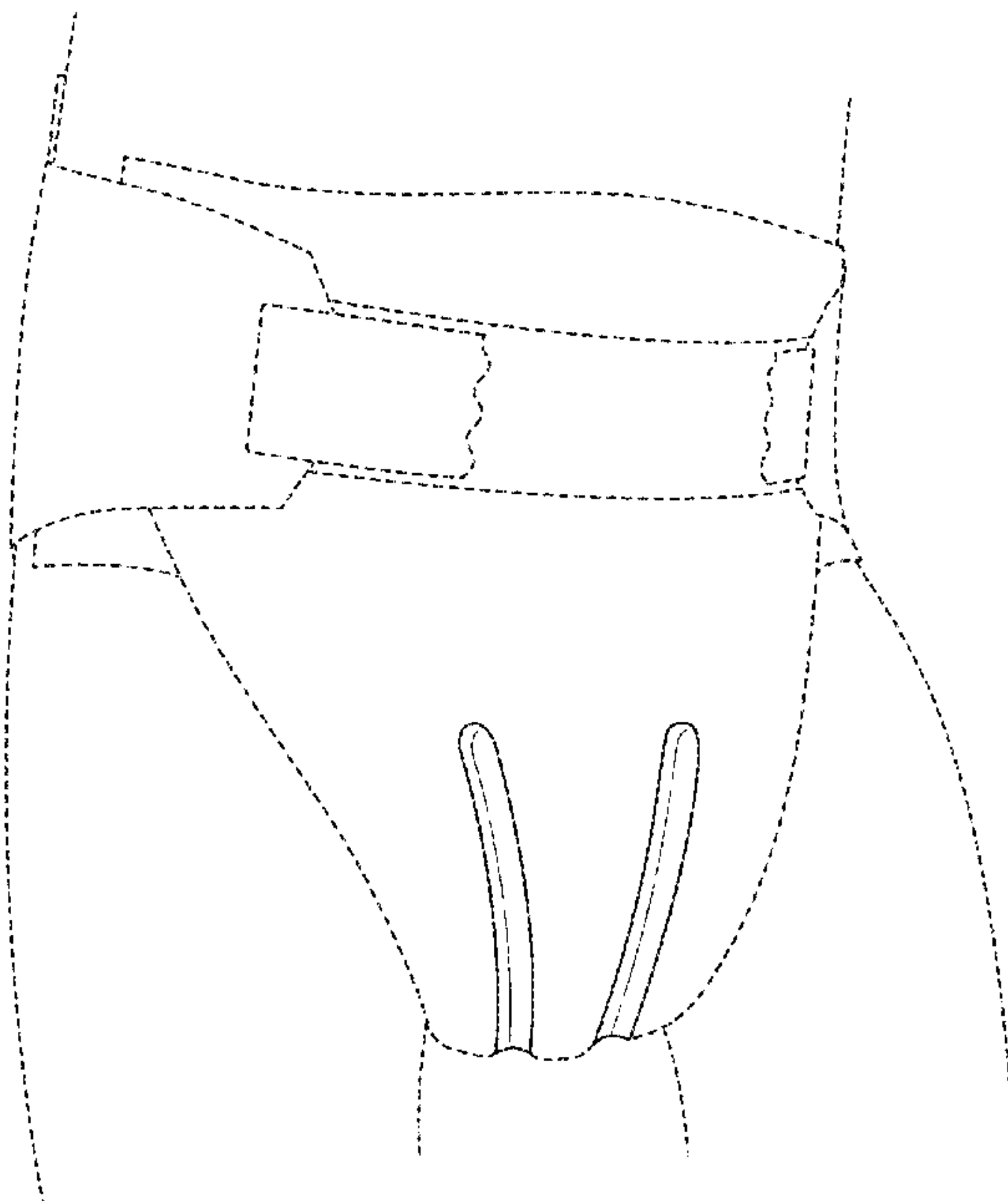

(56)

References Cited

U.S. PATENT DOCUMENTS

D561,334 S	*	2/2008	Martynus et al.	D24/126
D607,560 S	*	1/2010	Bruzadin et al.	D24/124
D631,958 S	*	2/2011	Marcelo et al.	D24/125
D648,849 S	*	11/2011	Houle	D24/124
D651,306 S	*	12/2011	Misiti et al.	D24/125
D715,923 S	*	10/2014	Cardin et al.	D24/125
D721,804 S	*	1/2015	Cutshaw et al.	D24/126

* cited by examiner

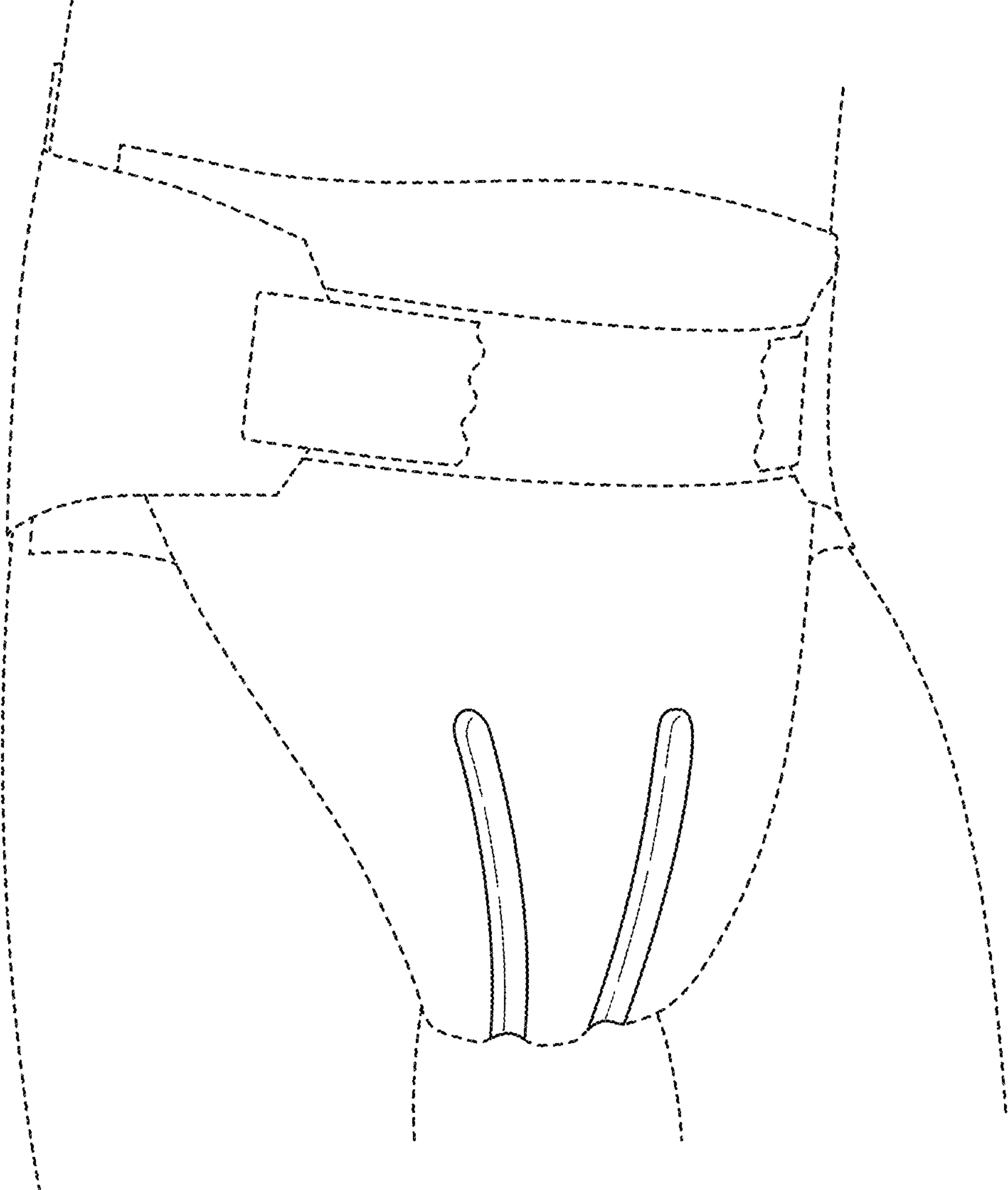

Fig. 1

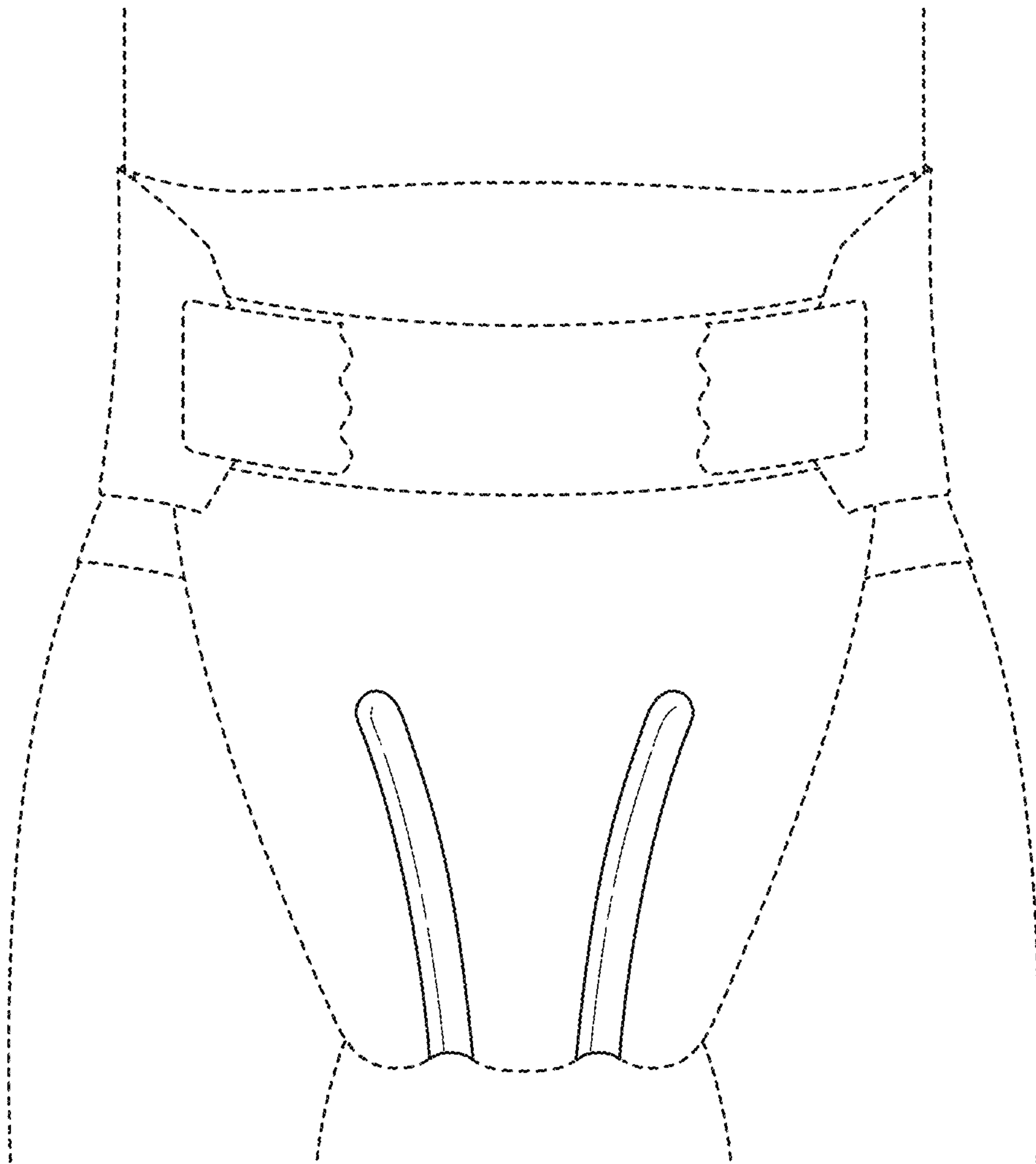

Fig. 2

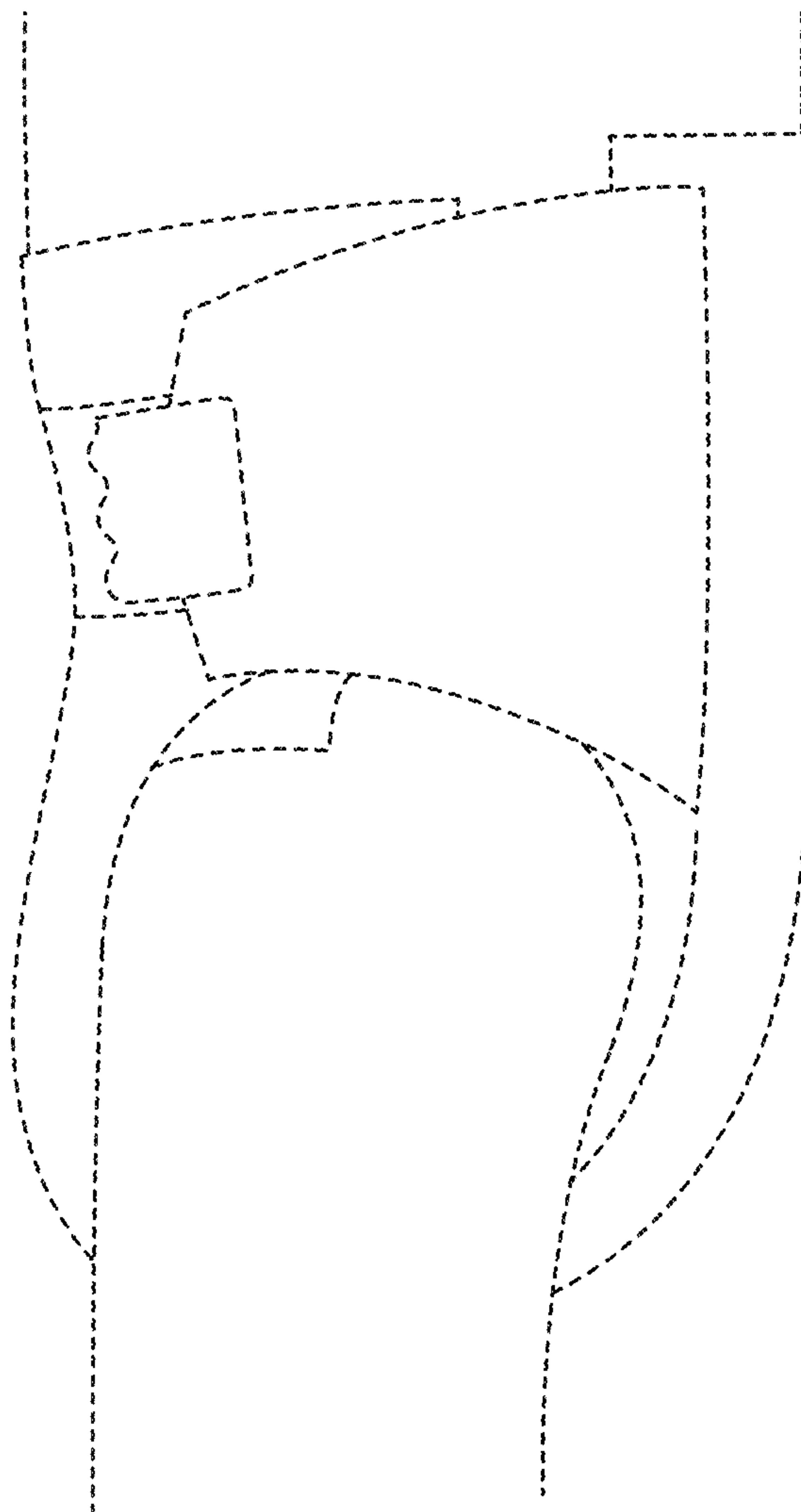

Fig. 3

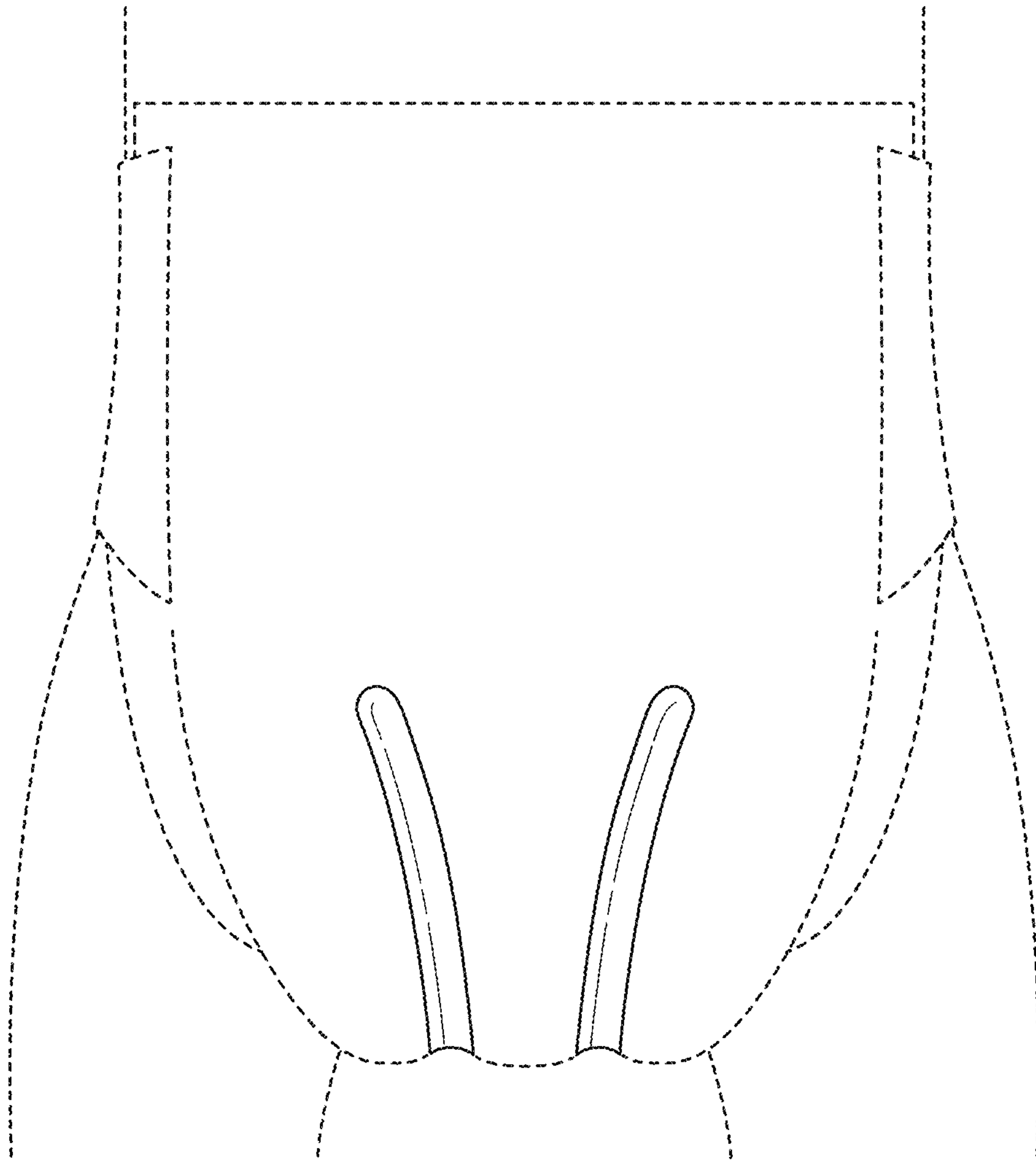

Fig. 4

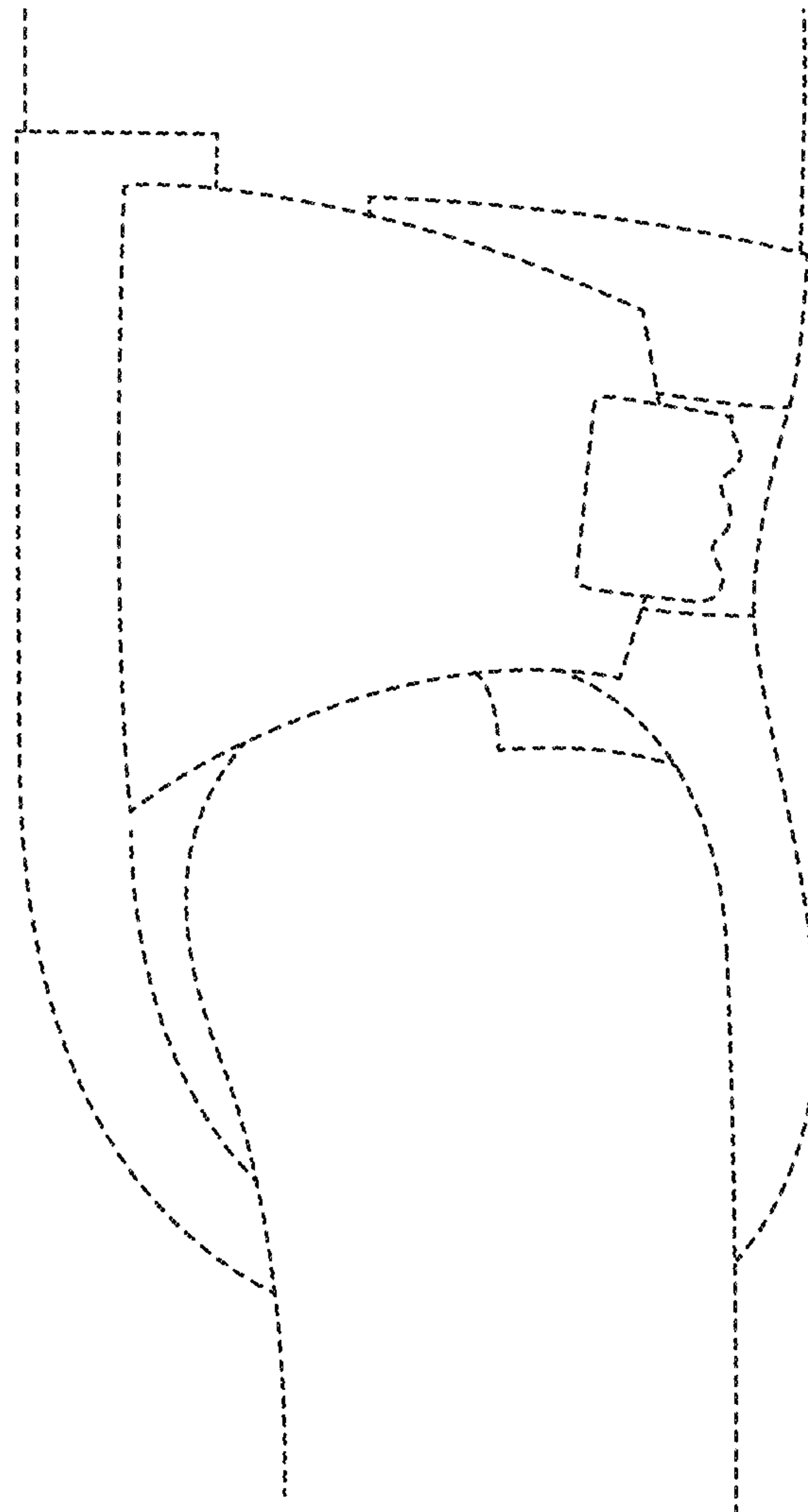

Fig. 5

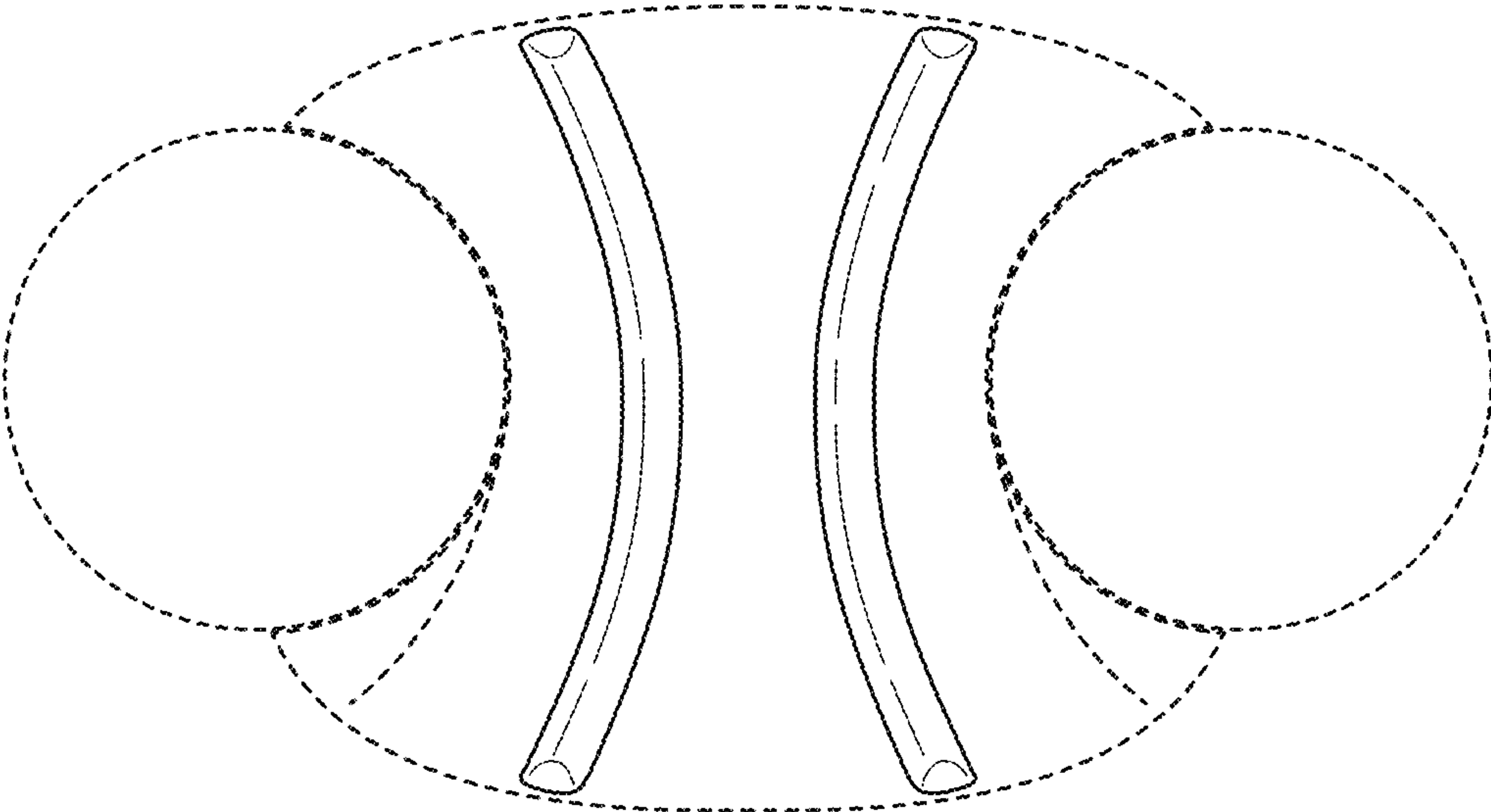

Fig. 6