



US00D783623S

(12) **United States Design Patent**
Crisp et al.

(10) **Patent No.:** **US D783,623 S**
(45) **Date of Patent:** **** Apr. 11, 2017**

(54) **INFORMATION HANDLING SYSTEM
STORAGE DEVICE CARRIER**

(71) Applicant: **Dell Products L.P.**, Round Rock, TX
(US)

(72) Inventors: **Richard A. Crisp**, Austin, TX (US);
Bernard D. Strmiska, Round Rock,
TX (US); **Mark Gilson**, Austin, TX
(US); **Jared Mockler**, Olathe, KS (US);
Reut Kovetz, Baltimore, MD (US)

(73) Assignee: **Dell Products L.P.**, Round Rock, TX
(US)

(**) Term: **15 Years**

(21) Appl. No.: **29/545,368**

(22) Filed: **Nov. 12, 2015**

(51) **LOC (10) Cl.** **14-02**

(52) **U.S. Cl.**
USPC **D14/439**; D14/432

(58) **Field of Classification Search**
USPC D14/300–302, 308–313, 314, 348,
D14/353–355, 432, 439–446, 240;
361/679.02, 679.31, 679.5, 690, 694,
361/679.23, 801, 802; 312/332.1, 334.1;
D13/162; D10/50
CPC B65H 1/00; B65H 1/266; B65H 2402/441;
B65H 2405/311; B65H 2405/313
See application file for complete search history.

(56) **References Cited**

U.S. PATENT DOCUMENTS

D377,482 S * 1/1997 Geck D14/368
D415,747 S * 10/1999 Wu D14/442
D447,484 S * 9/2001 Reznikov D14/441
D475,061 S * 5/2003 Huang D14/432

D490,083 S * 5/2004 Wu D14/439
D530,704 S * 10/2006 Cortes D14/188
D535,298 S * 1/2007 Cochrane D14/444
D556,204 S * 11/2007 Tosh D14/439
D565,573 S * 4/2008 Alo D14/435
D681,635 S * 5/2013 Wang D14/366
D743,404 S * 11/2015 Ignomirello D14/432
D754,665 S * 4/2016 Zhang D14/432
D768,135 S * 10/2016 Ignomirello D14/432
D768,136 S * 10/2016 Ignomirello D14/432
D769,210 S * 10/2016 Haro D14/159
2006/0285287 A1 * 12/2006 Chen G06F 1/187
361/679.33
2007/0087586 A1 * 4/2007 Karamooz H01R 43/205
439/65
2012/0285738 A1 * 11/2012 Cochrane H05K 9/0015
174/382

* cited by examiner

Primary Examiner — Austin Murphy

(74) *Attorney, Agent, or Firm* — Terrile, Cannatti,
Chambers & Holland, LLP; Robert W. Holland

(57) **CLAIM**

We claim the ornamental design for an information handling system storage device carrier, as shown and described.

DESCRIPTION

FIG. 1 is a front perspective view of the information handling system storage device carrier comprising the present invention;

FIG. 2 is a front view thereof;

FIG. 3 is a left side view thereof;

FIG. 4 is a right side view thereof;

FIG. 5 is a top view thereof; and,

FIG. 6 is a bottom view thereof.

Broken lines shown in the drawings illustrate portions of the information handling system storage device carrier, and form no part of the claimed design.

1 Claim, 5 Drawing Sheets

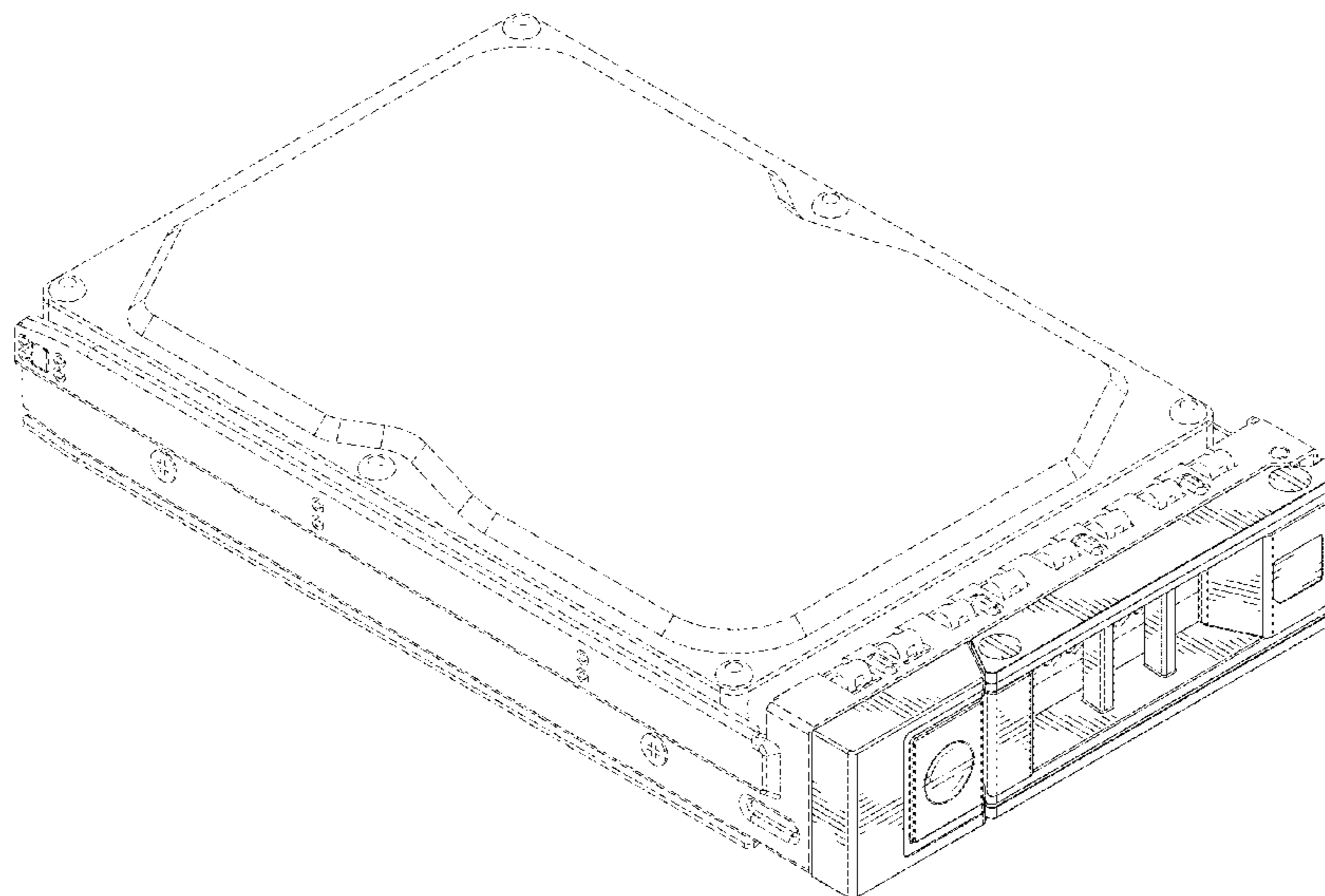

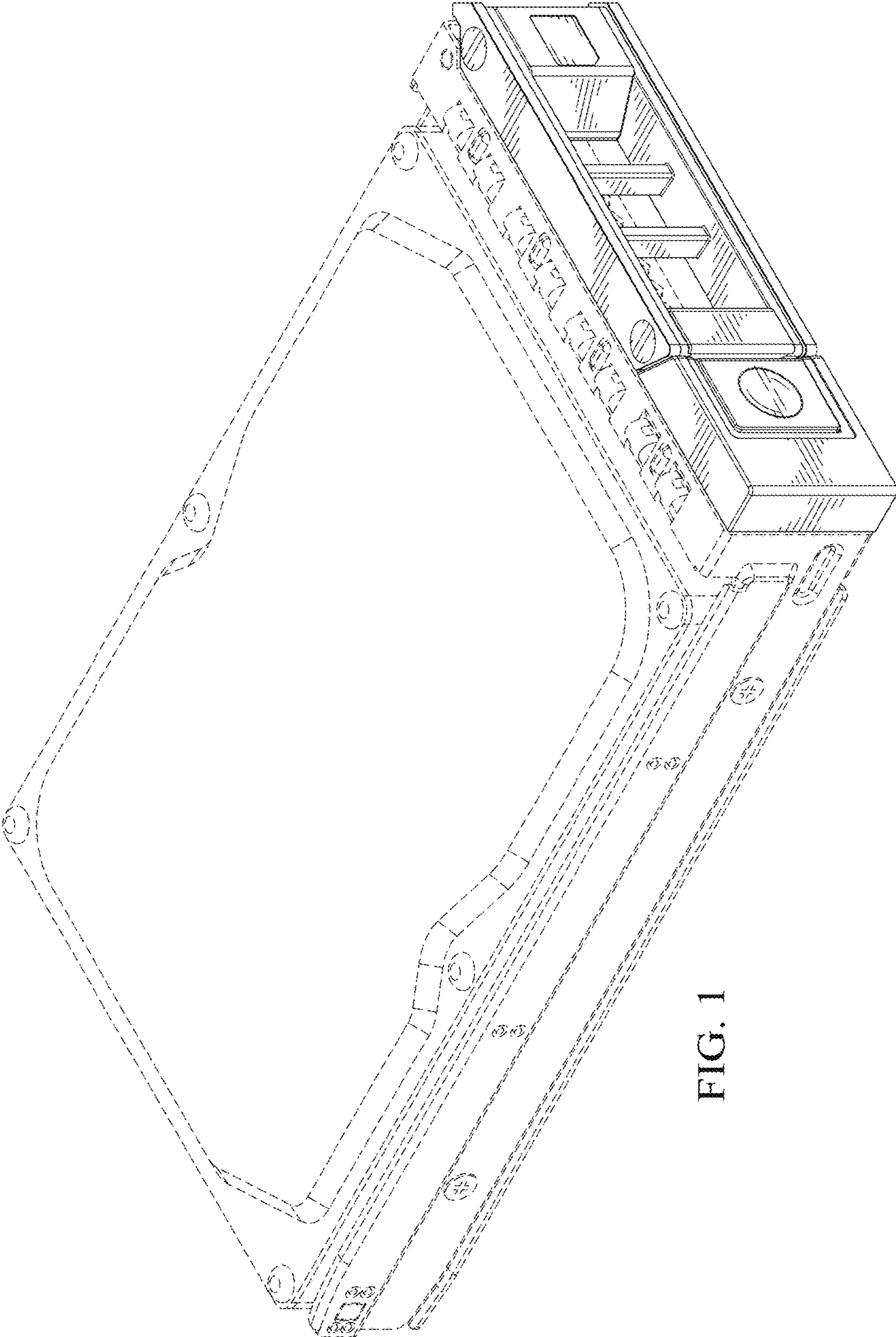

FIG. 1

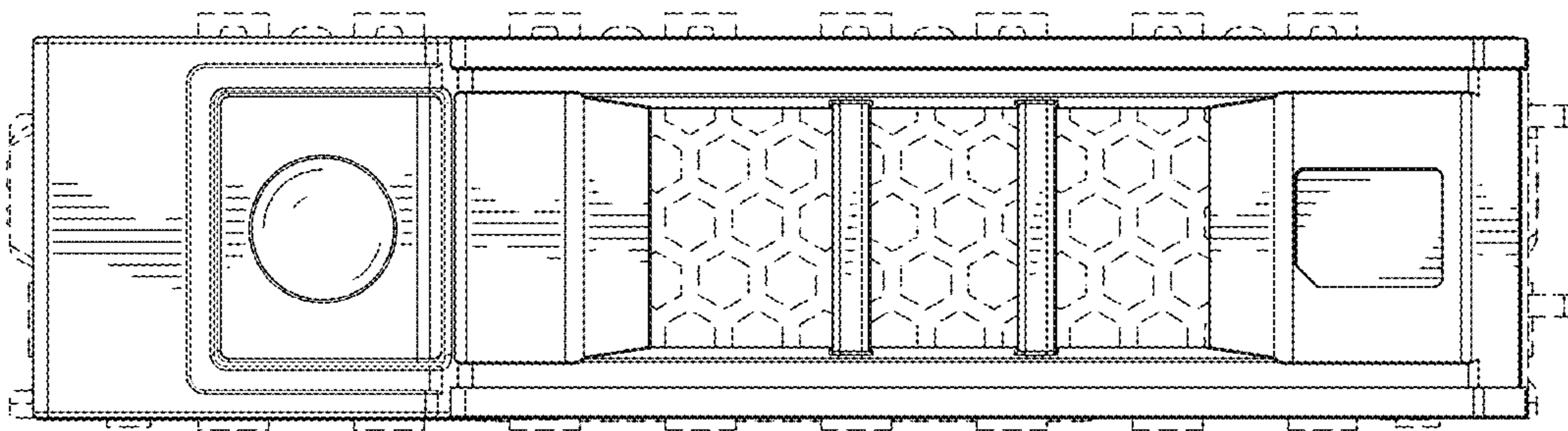

FIG. 2

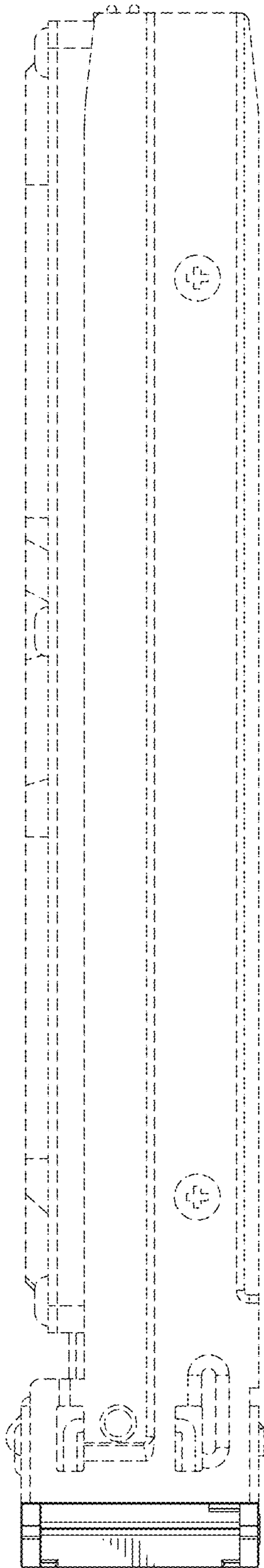

FIG. 3

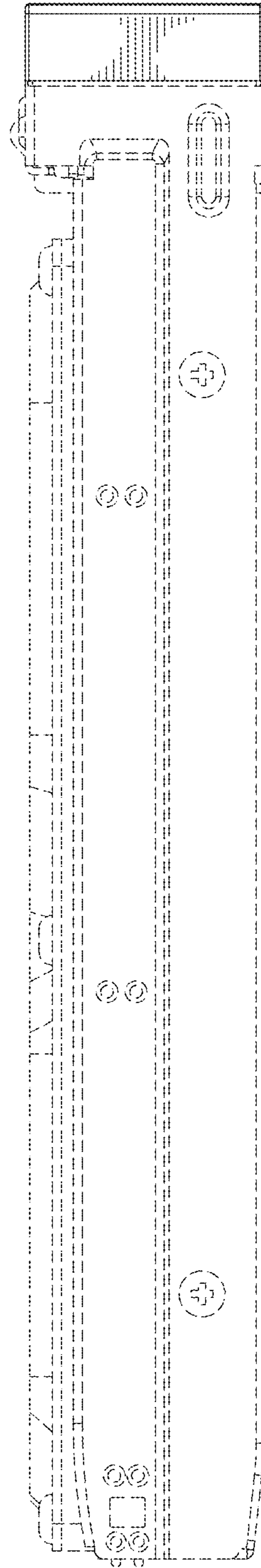

FIG. 4

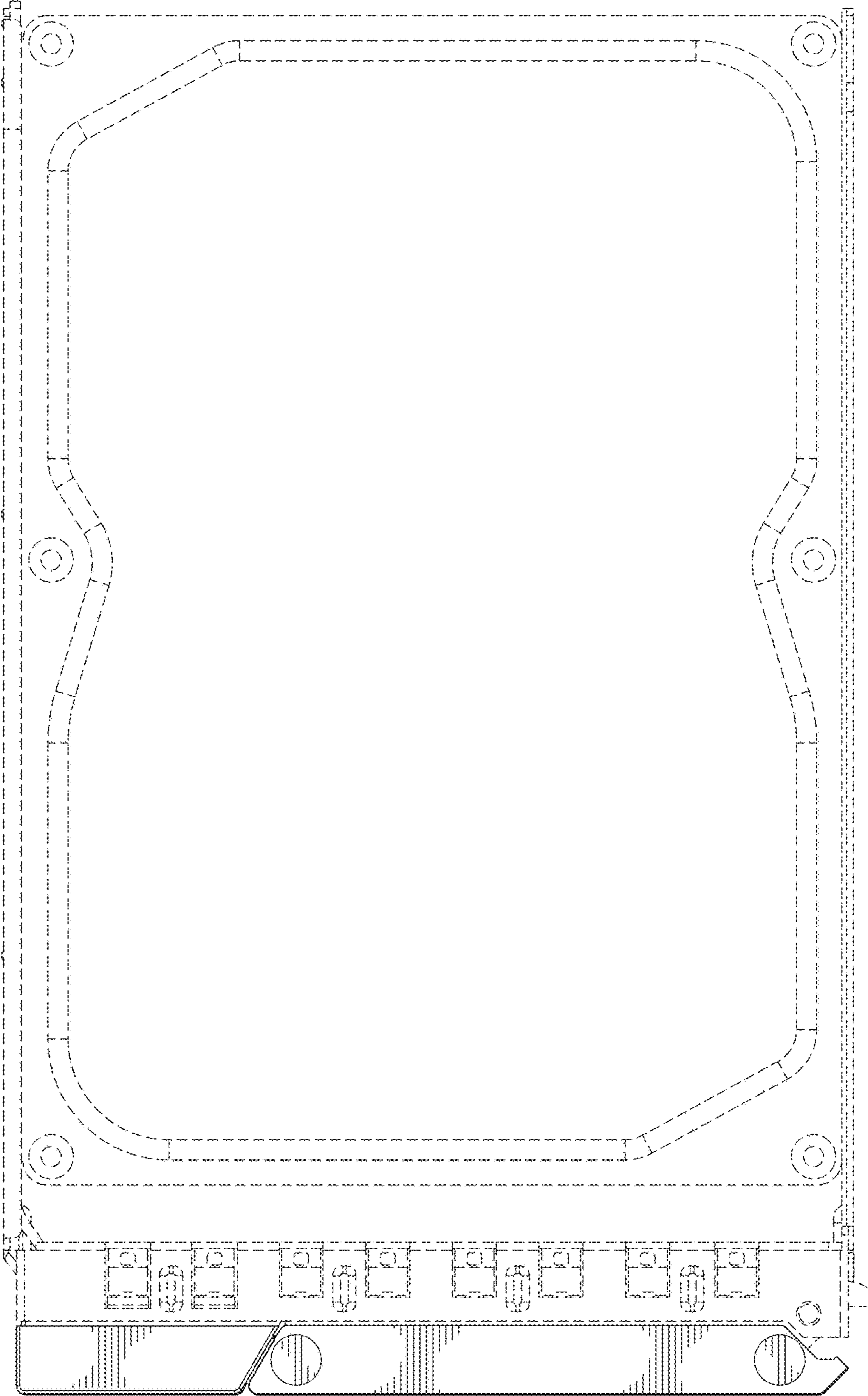

FIG. 5

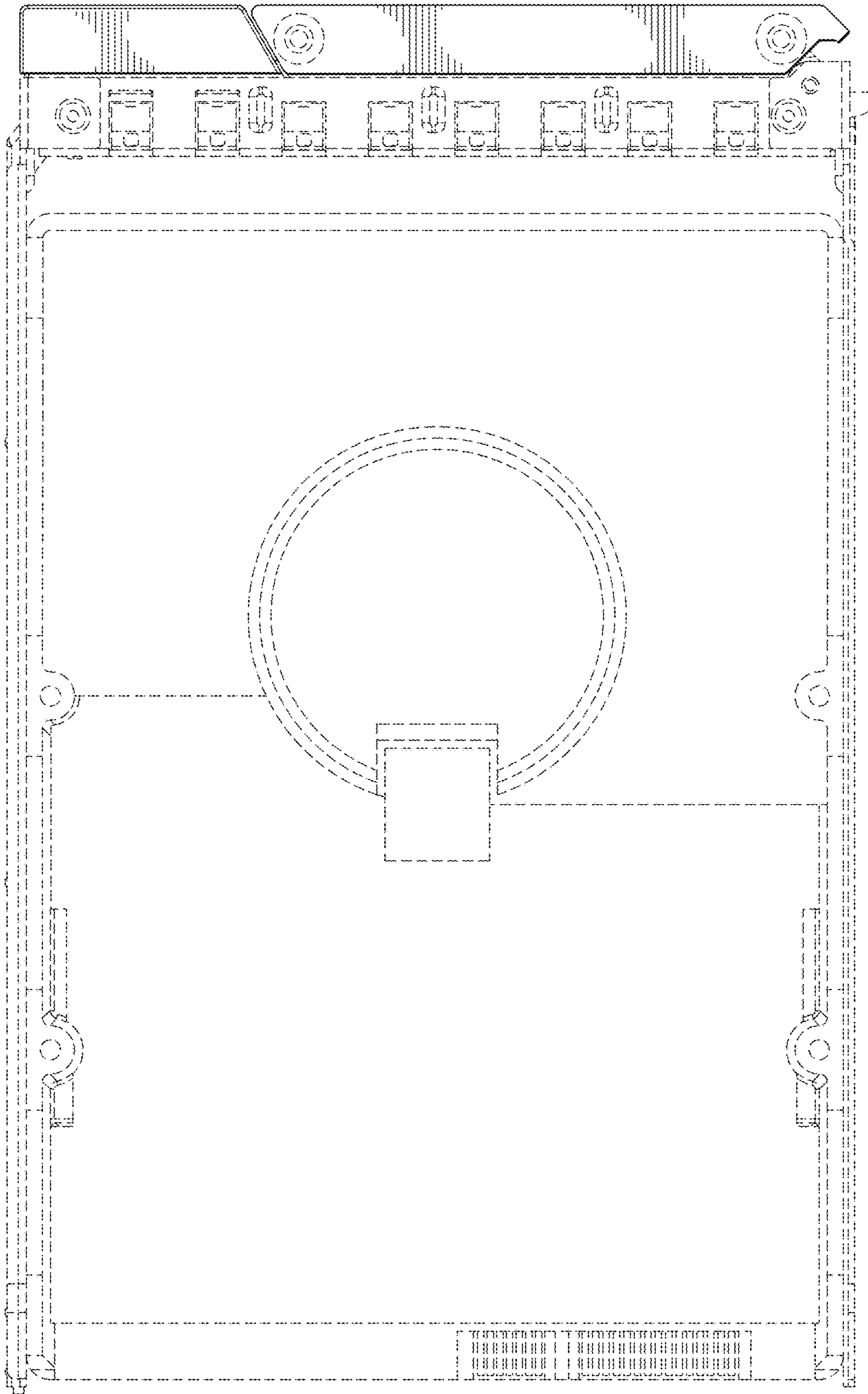

FIG. 6