



US00D783615S

(12) **United States Design Patent**
Hong

(10) **Patent No.:** **US D783,615 S**

(45) **Date of Patent:** **** Apr. 11, 2017**

(54) **INTERACTIVE DEVICE**

(71) Applicant: **IPEVO CORP.**, Taipei (TW)

(72) Inventor: **Royce Yu-Chun Hong**, Taipei (TW)

(73) Assignee: **IPEVO CORP.**, Taipei (TW)

(**) Term: **15 Years**

(21) Appl. No.: **29/557,266**

(22) Filed: **Mar. 8, 2016**

(51) **LOC (10) Cl.** **14-02**

(52) **U.S. Cl.**
USPC **D14/411**

(58) **Field of Classification Search**
USPC D14/372, 496, 432, 371, 125, 126, 129,
D14/299, 411; D16/300-342; 351/158,
351/153, 144; 345/7-9, 905; 455/344;
348/115, 53, 121, 739

CPC G02B 27/017; G06F 3/016; G06F 3/033;
G06F 3/0317; G06F 3/03545; G06F
3/041; G06K 9/222

See application file for complete search history.

(56) **References Cited**

U.S. PATENT DOCUMENTS

D688,666 S *	8/2013	Kowari	D14/411
D690,303 S *	9/2013	Avery	D14/167
D708,598 S *	7/2014	Robinson	D14/218
D709,887 S *	7/2014	Yagi	D14/411
D715,298 S *	10/2014	Hong	D14/411

D720,348 S *	12/2014	Robinson	D14/411
D749,173 S *	2/2016	Walker	D19/180
D758,988 S *	6/2016	An	D14/138 R
D770,453 S *	11/2016	Sumsion	D14/411
D771,047 S *	11/2016	Martindale	D14/411
2004/0229645 A1 *	11/2004	Montgomery	H04M 1/0202 455/556.1
2009/0198750 A1 *	8/2009	Lin	B43K 7/005 708/107

* cited by examiner

Primary Examiner — Austin Murphy

(74) *Attorney, Agent, or Firm* — Alan D. Kamrath;
Kamrath IP Lawfirm, P.A.

(57) **CLAIM**

The ornamental design for an interactive device, as shown and described.

DESCRIPTION

FIG. 1 is a perspective view of an interactive device in accordance with the design;
FIG. 2 is a front view thereof;
FIG. 3 is a rear view thereof;
FIG. 4 is a left view thereof;
FIG. 5 is a right view thereof;
FIG. 6 is a top view thereof; and,
FIG. 7 is a bottom view thereof.

The broken line is for illustrative purposes only and forms no part of the claimed design.

1 Claim, 4 Drawing Sheets

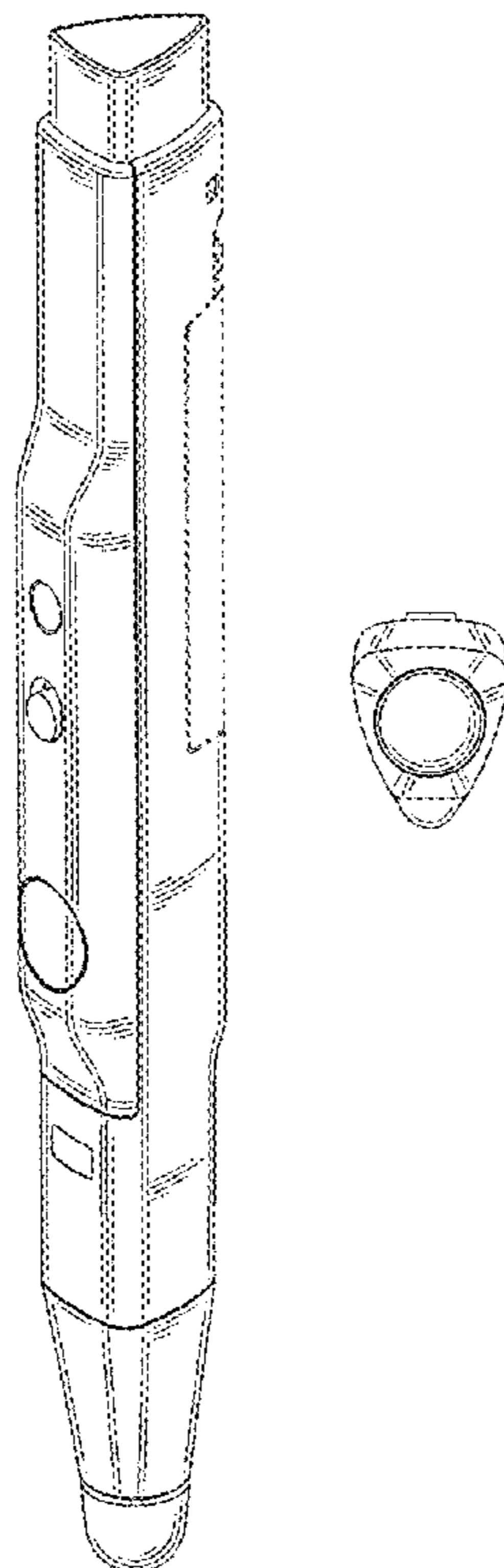

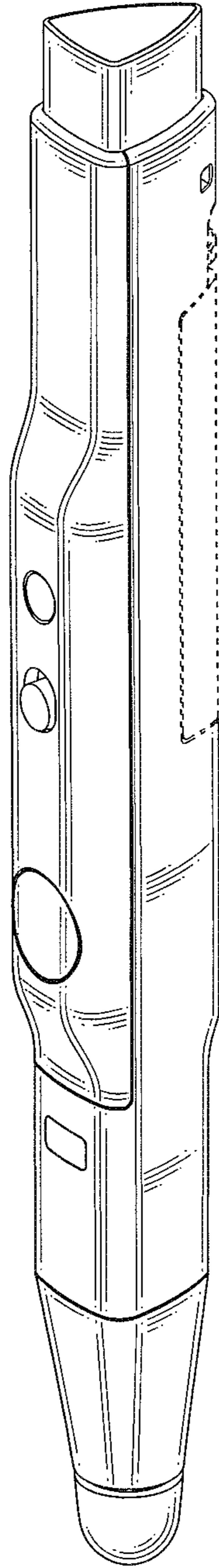

FIG. 1

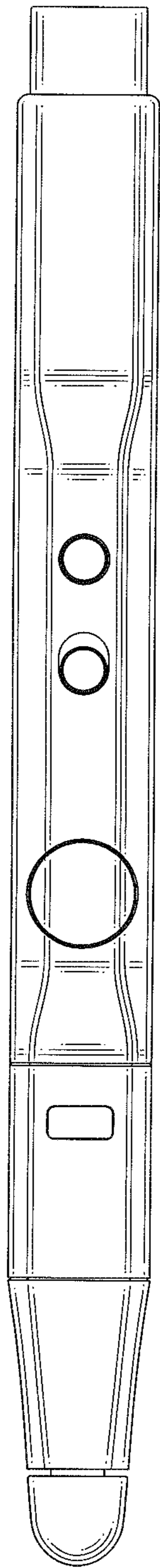

FIG. 2

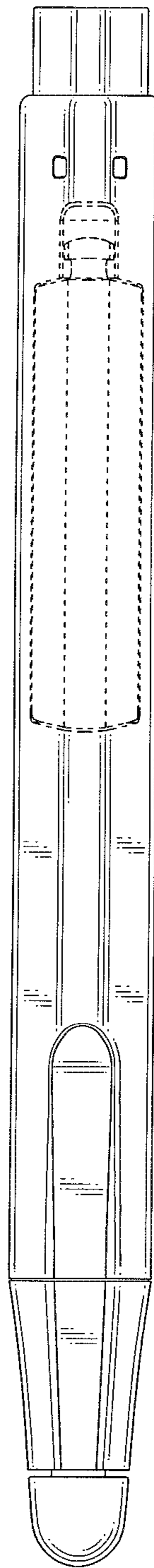

FIG. 3

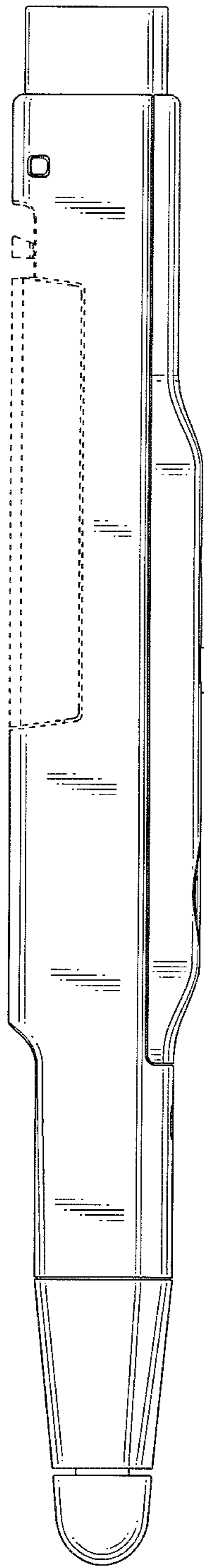

FIG. 4

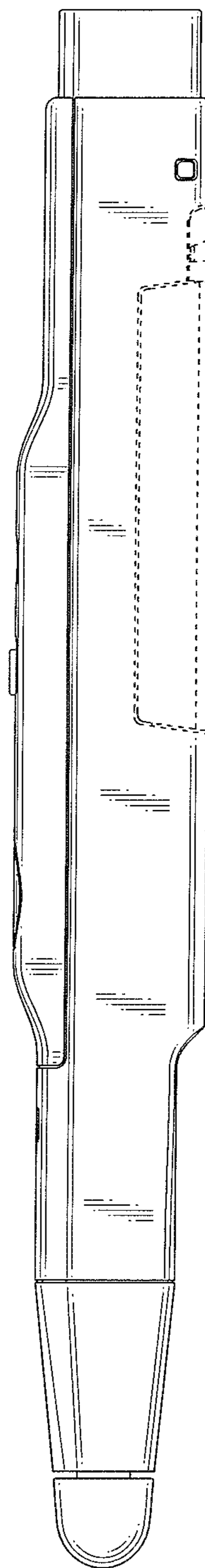

FIG. 5

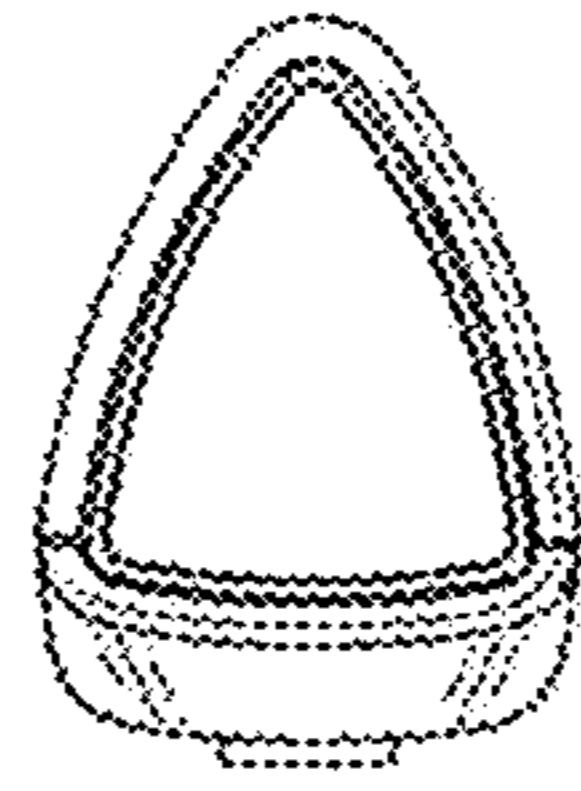

FIG. 6

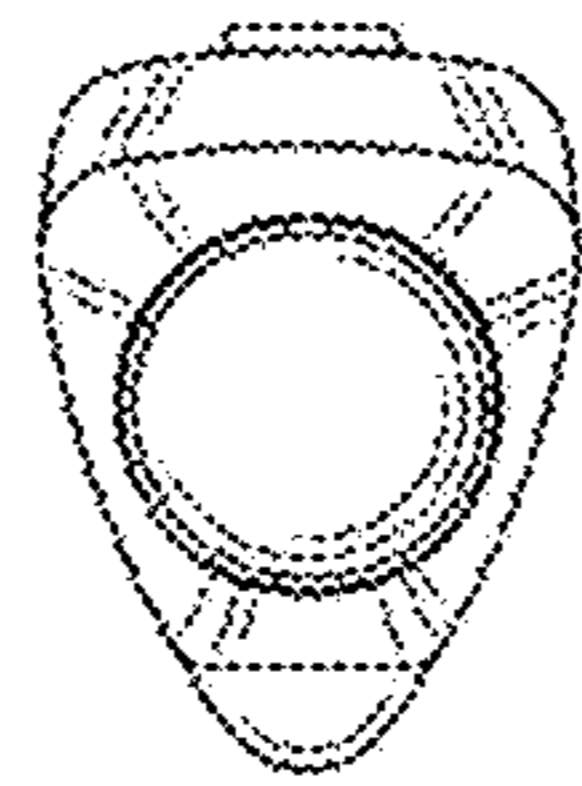

FIG. 7