



US00D783280S

(12) **United States Design Patent** (10) **Patent No.:** **US D783,280 S**
Weinman (45) **Date of Patent:** **** Apr. 11, 2017**

(54) **COMBINATION MOBILE DEVICE CASE AND PURSE**

D688,865 S * 9/2013 Tsai D3/249
D728,930 S * 5/2015 Kalbach D3/247

* cited by examiner

(71) Applicant: **Barney Weinman**, Santa Barbara, CA (US)

Primary Examiner — Holly Baynham

(74) *Attorney, Agent, or Firm* — Sandy Lipkin

(72) Inventor: **Barney Weinman**, Santa Barbara, CA (US)

(57) **CLAIM**

The ornamental design for combination mobile device case and purse, as shown and described.

(**) Term: **15 Years**

DESCRIPTION

(21) Appl. No.: **29/573,732**

(22) Filed: **Aug. 9, 2016**

(51) **LOC (10) Cl.** **03-01**

(52) **U.S. Cl.**
USPC **D3/249**

(58) **Field of Classification Search**
USPC D3/247, 249, 318
CPC .. A45C 3/06; A45C 1/024; A45C 3/08; A45C 1/06

See application file for complete search history.

(56) **References Cited**

U.S. PATENT DOCUMENTS

- 7,228,651 B1 * 6/2007 Saari A45F 5/004
224/162
- 7,347,325 B2 * 3/2008 O'Neill A45C 1/06
206/38
- 7,578,446 B2 * 8/2009 Yen G06K 19/07741
235/486
- D627,786 S * 11/2010 Hsia D14/435
- D630,848 S * 1/2011 Long D3/247

FIG. 1 is a front elevational view of the combination mobile device case and purse showing my new design;
 FIG. 2 is a top plan view thereof;
 FIG. 3 is a back elevational view thereof;
 FIG. 4 is a bottom plan view thereof;
 FIG. 5 is a side elevational view thereof;
 FIG. 6 is an opposite side view thereof;
 FIG. 7 is a perspective view of mobile device case detached from the purse;
 FIG. 8 is a front elevational view thereof;
 FIG. 9 is a top plan view thereof;
 FIG. 10 is a back elevational view thereof;
 FIG. 11 is a bottom plan view thereof;
 FIG. 12 is a side elevational view thereof; and,
 FIG. 13 is an opposite side view thereof.

The broken lines showing a portion of the handle, clips and stitching are for the purpose of illustrating environment and form no part of the claimed design.

The mobile device case is shown detached for clarity and ease of illustration.

1 Claim, 7 Drawing Sheets

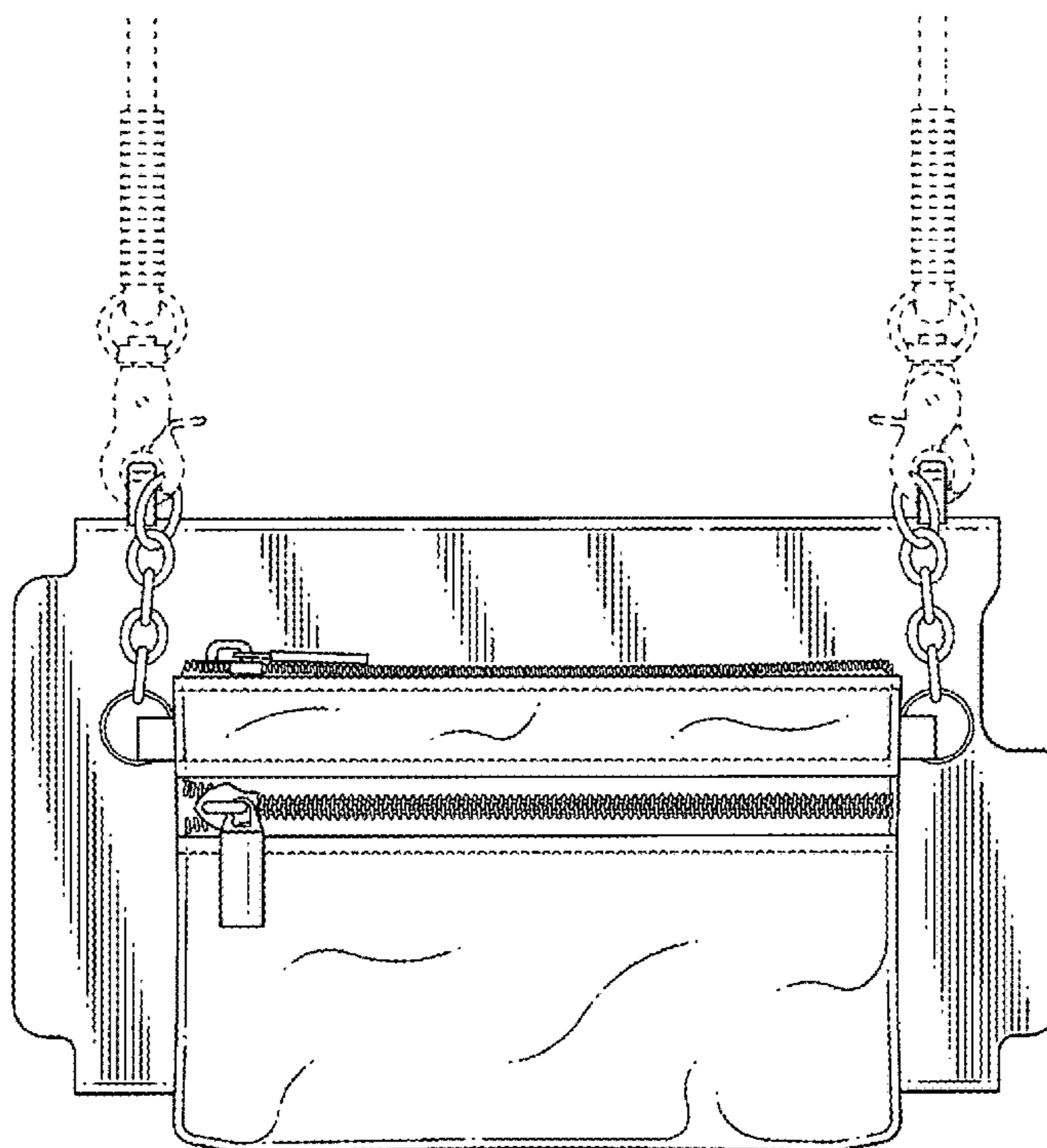

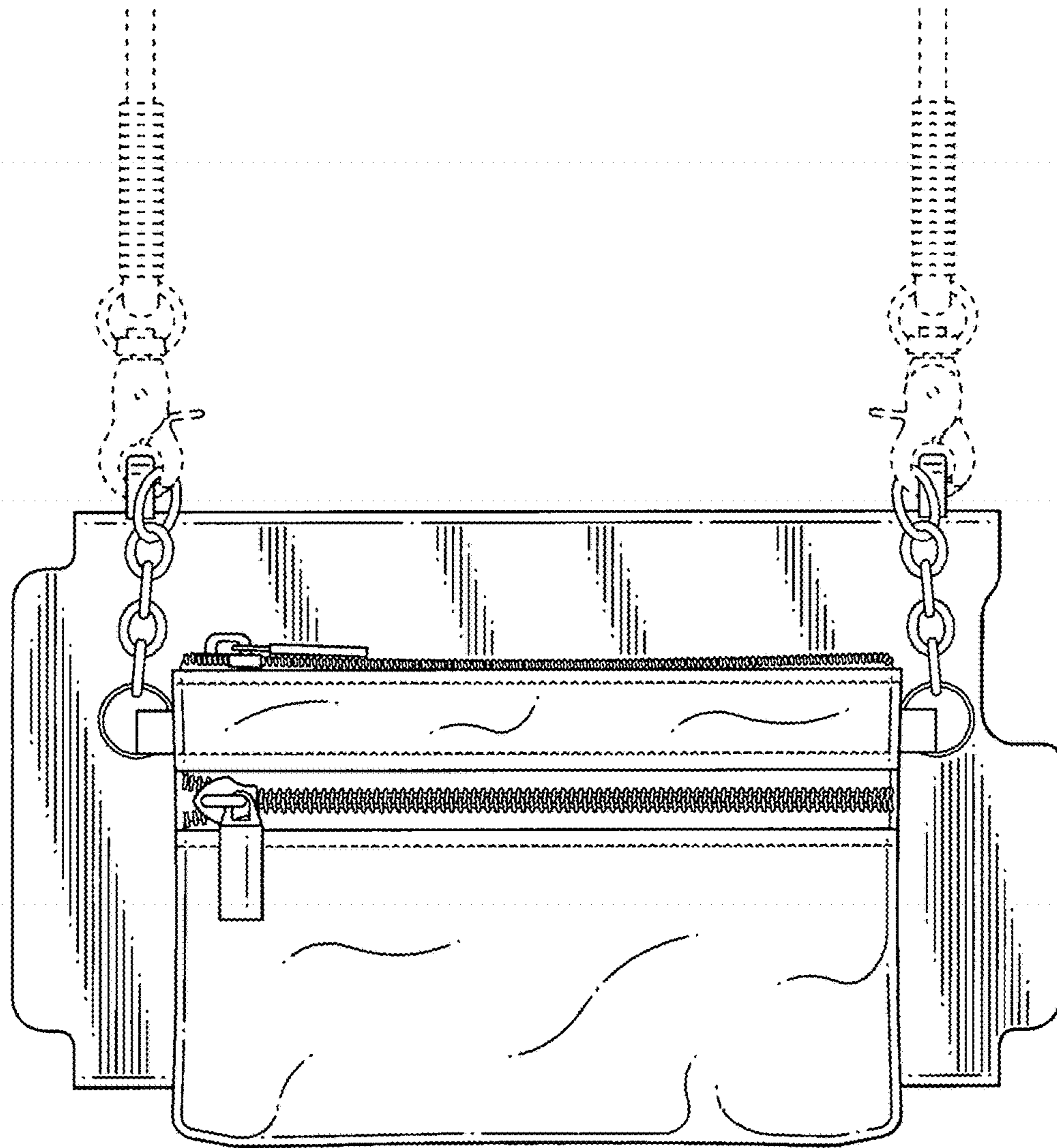

FIG. 1

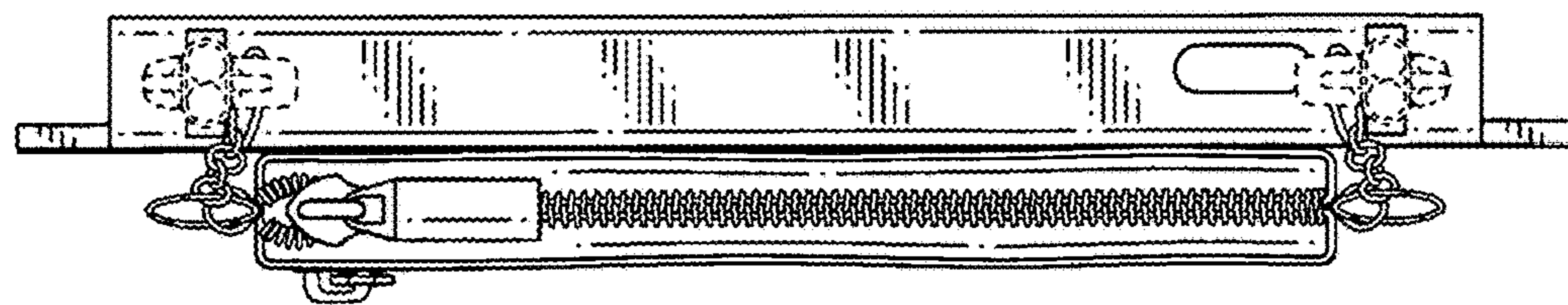

FIG. 2

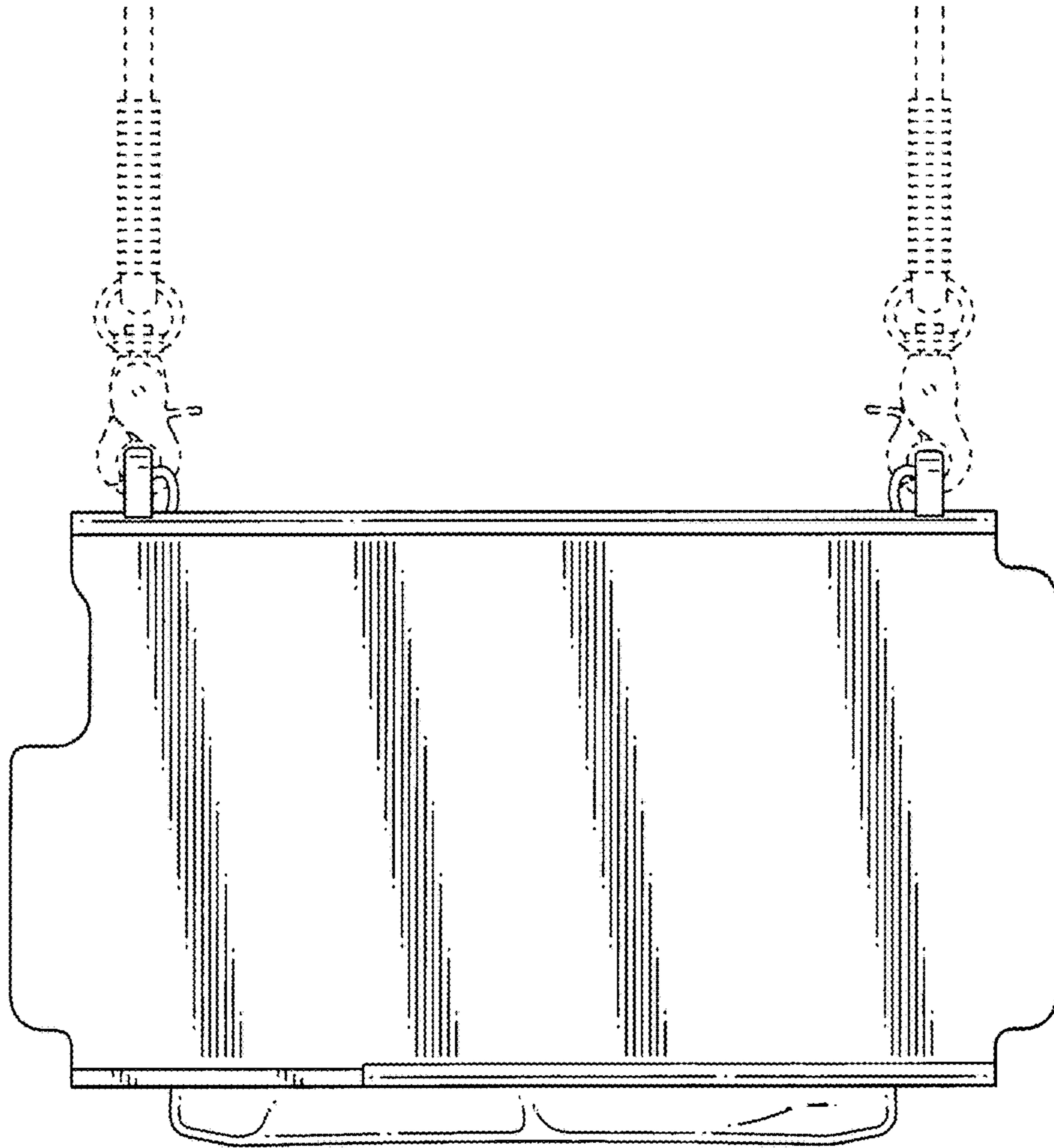

FIG. 3

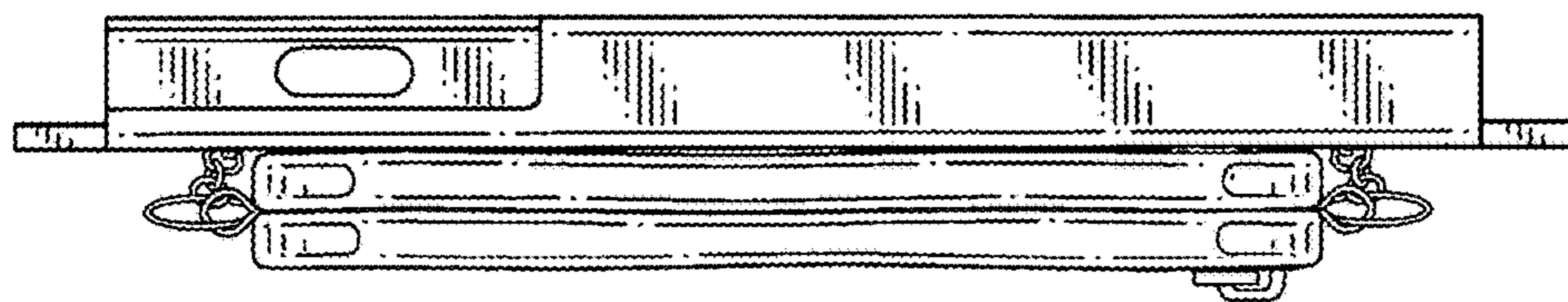

FIG. 4

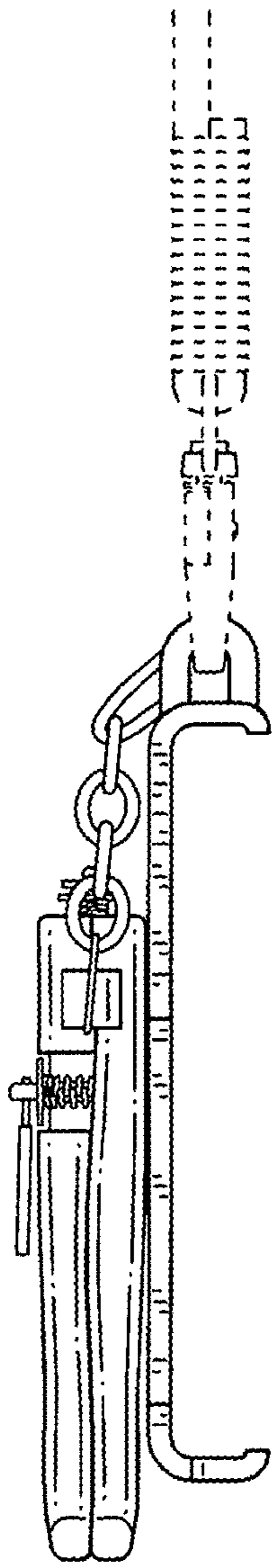

FIG. 5

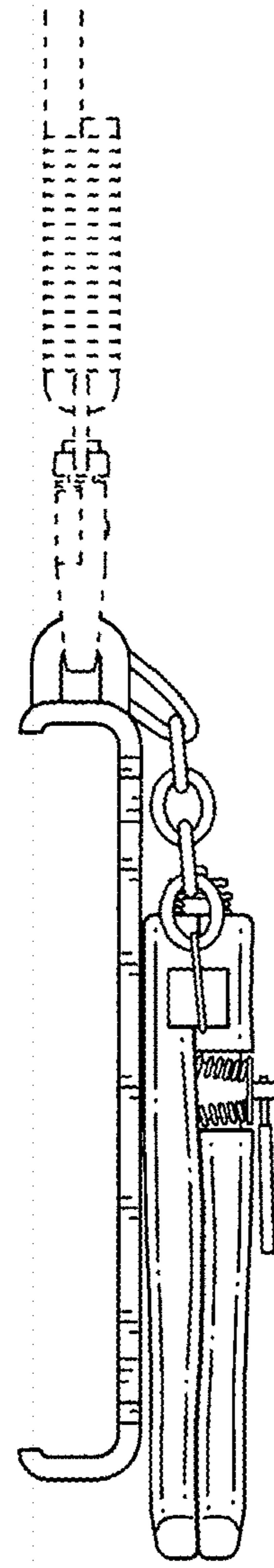

FIG. 6

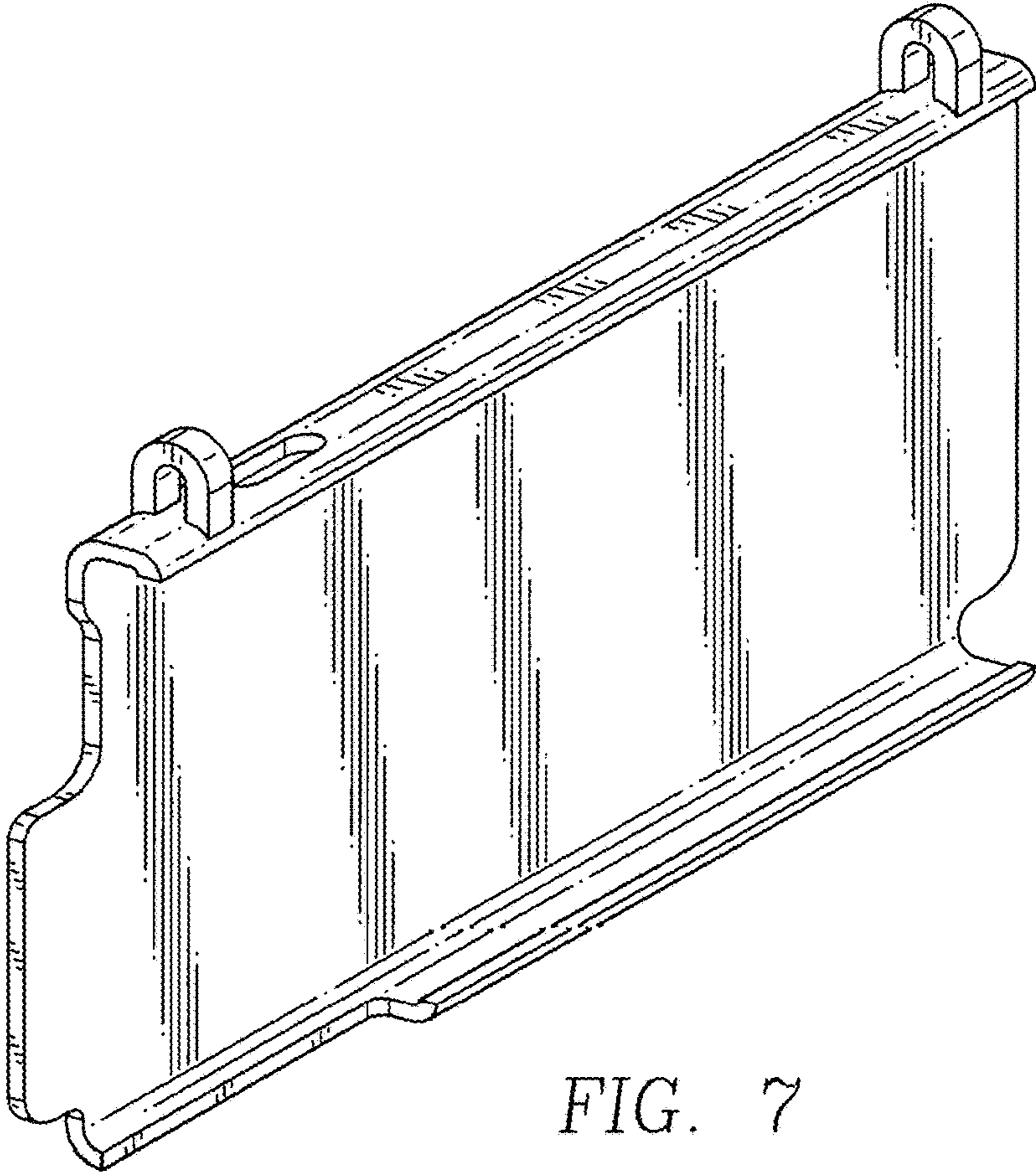

FIG. 7

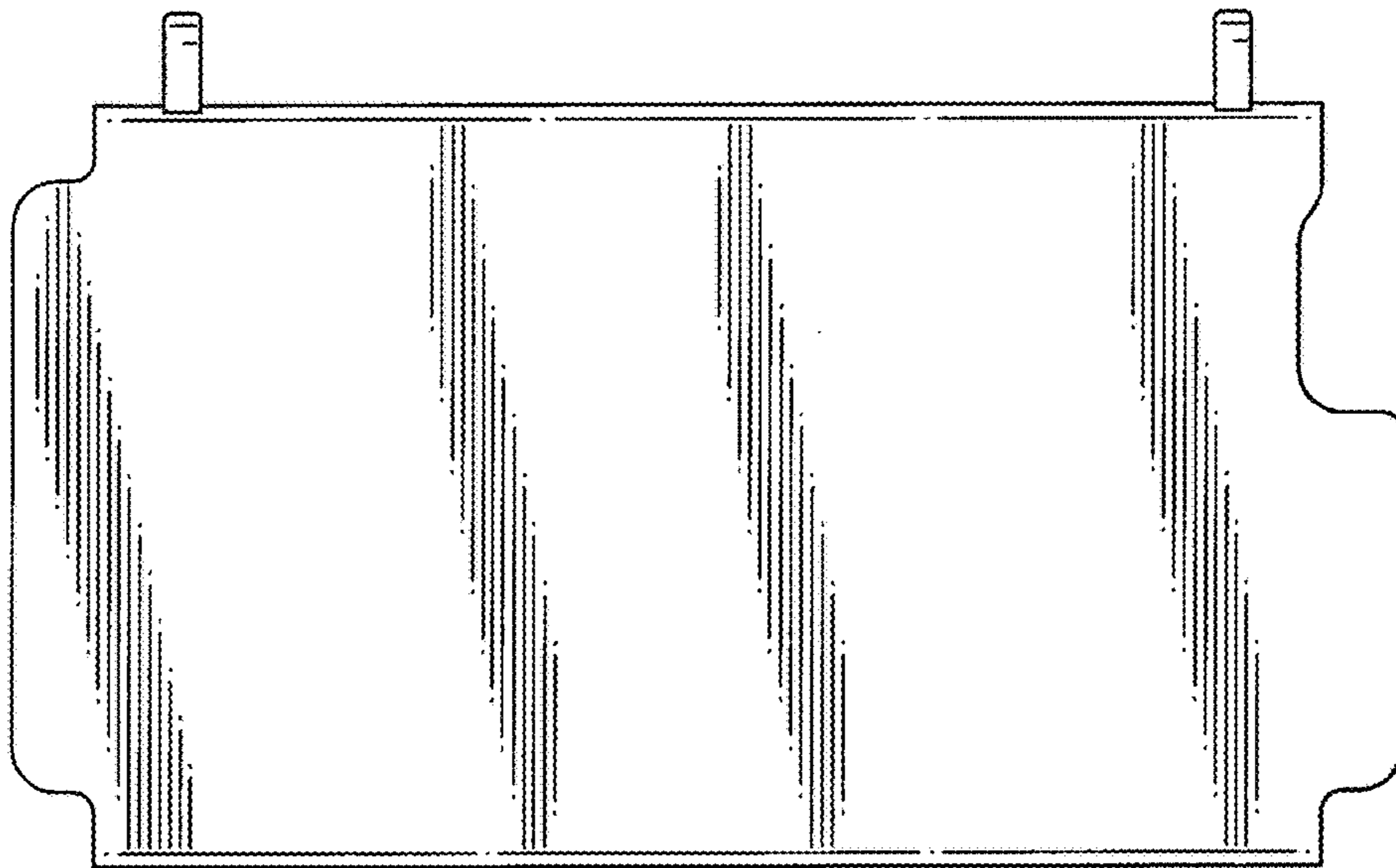

FIG. 8

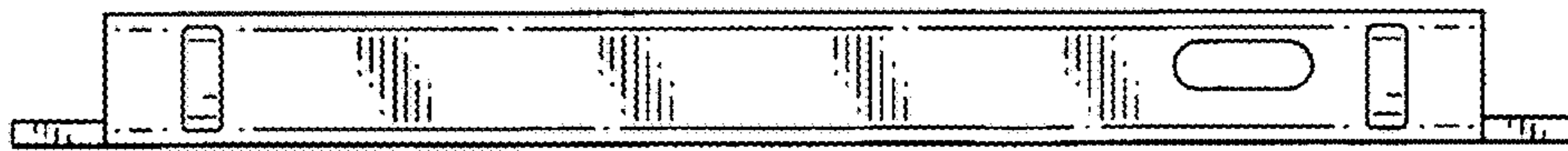

FIG. 9

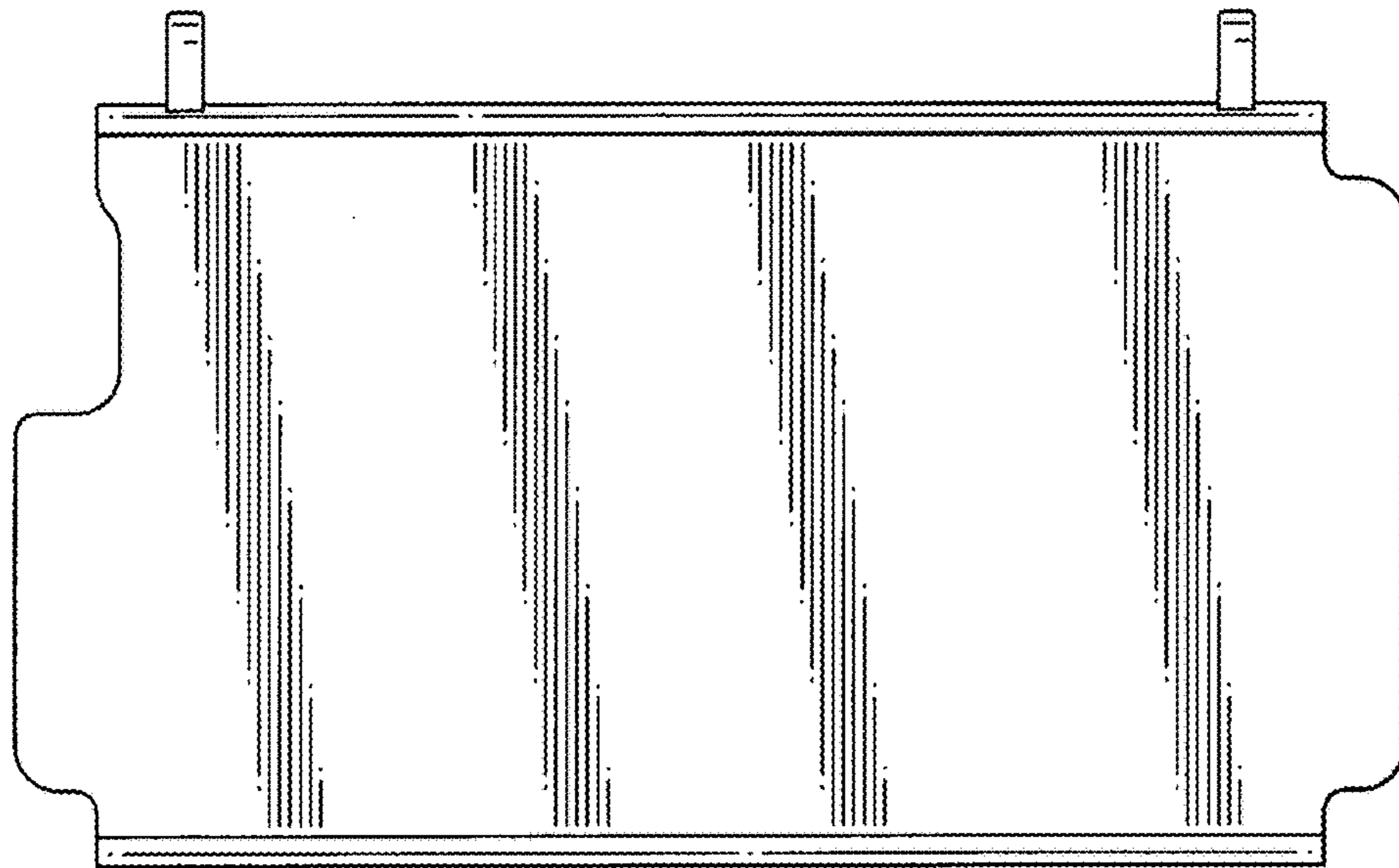

FIG. 10

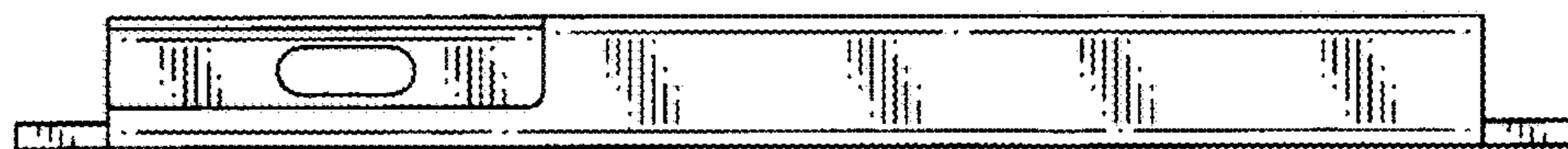

FIG. 11

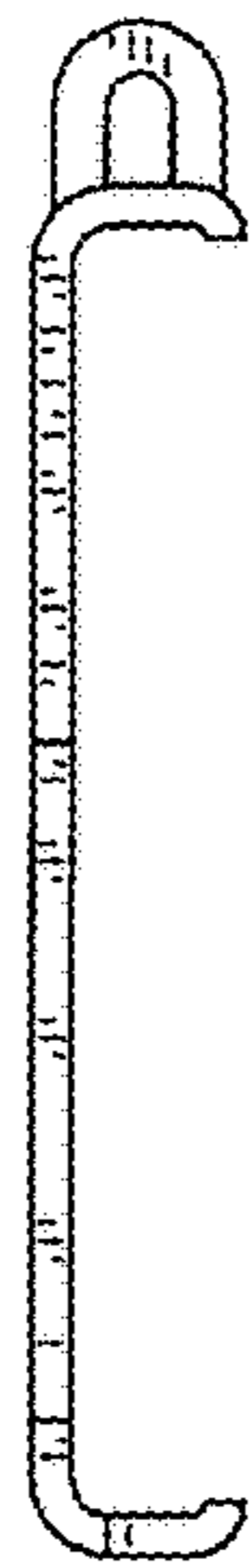

FIG. 12



FIG. 13

