



US00D783201S

(12) **United States Design Patent** (10) **Patent No.:** **US D783,201 S**
Pierce et al. (45) **Date of Patent:** **** Apr. 4, 2017**

- (54) **WINDSHIELD FOR LIGHTERS**
- (71) Applicants: **Josh Pierce**, Pasadena, CA (US);
Jeremy Douglas Politte, Pasadena, CA (US)
- (72) Inventors: **Josh Pierce**, Pasadena, CA (US);
Jeremy Douglas Politte, Pasadena, CA (US)

4,634,374 A	1/1987	Herko	
5,044,933 A *	9/1991	Yang	F23Q 2/50 431/144
D636,119 S *	4/2011	Worlock	D27/161
D658,329 S *	4/2012	Katz	D27/125
D680,683 S	4/2013	Hancock et al.	
D735,935 S *	8/2015	Burrell	D27/183
D752,806 S *	3/2016	Barton	D27/161

(Continued)

FOREIGN PATENT DOCUMENTS

CN	203215717	9/2013
----	-----------	--------

- (**) Term: **15 Years**
- (21) Appl. No.: **29/540,277**
- (22) Filed: **Sep. 22, 2015**

Related U.S. Application Data

- (63) Continuation of application No. 14/755,568, filed on Jun. 30, 2015.
- (51) **LOC (10) Cl.** **27-05**
- (52) **U.S. Cl.**
USPC **D27/161**
- (58) **Field of Classification Search**
USPC D27/100-112, 120, 125-130, 136, 137, D27/138, 143, 161, 162-169, 172, 175, D27/180, 183, 193, 194, 195; D3/228, D3/229; D23/332, 341
CPC F23Q 2/36; F23Q 2/50
See application file for complete search history.

(56) **References Cited**

U.S. PATENT DOCUMENTS

2,505,047 A	4/1949	Horning	
2,494,322 A *	1/1950	Ward	F23Q 2/50 431/151
4,371,331 A	2/1983	Lee	
4,531,906 A	7/1985	Mizukami	

OTHER PUBLICATIONS

Flamebuddy by flamebuddy. dated 2016. found online [Nov. 4, 2016]. <http://www.flamebuddy.com/>.*

Primary Examiner — Robert M Spear
Assistant Examiner — Marissa J Cash
(74) *Attorney, Agent, or Firm* — Buche & Associates, P.C.; John K. Buche; Bryce A. Johnson

(57) **CLAIM**

The ornamental design for a windshield for lighters, as shown and described.

DESCRIPTION

FIG. 1 is a perspective view of the windshield for lighters; FIG. 2 is a front view of the windshield for lighters; FIG. 3 is a back view of the windshield for lighters; FIG. 4 is a left side view of the windshield for lighters; FIG. 5 is right side view of the windshield for lighters; FIG. 6 is a bottom view of the windshield for lighters; and, FIG. 7 is a top view of the windshield for lighters.

1 Claim, 4 Drawing Sheets

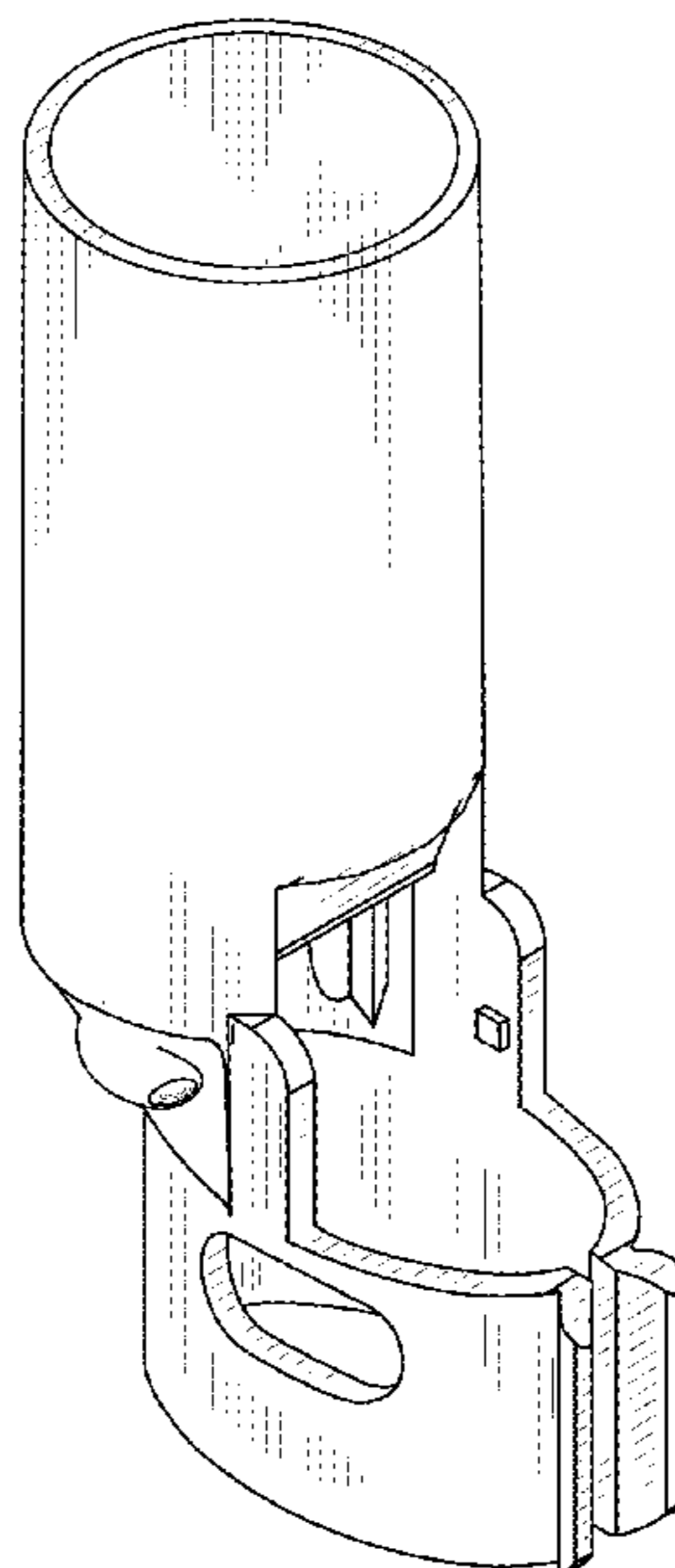

(56)

References Cited

U.S. PATENT DOCUMENTS

2014/0011144 A1* 1/2014 Hancock F23Q 2/50
431/350

* cited by examiner

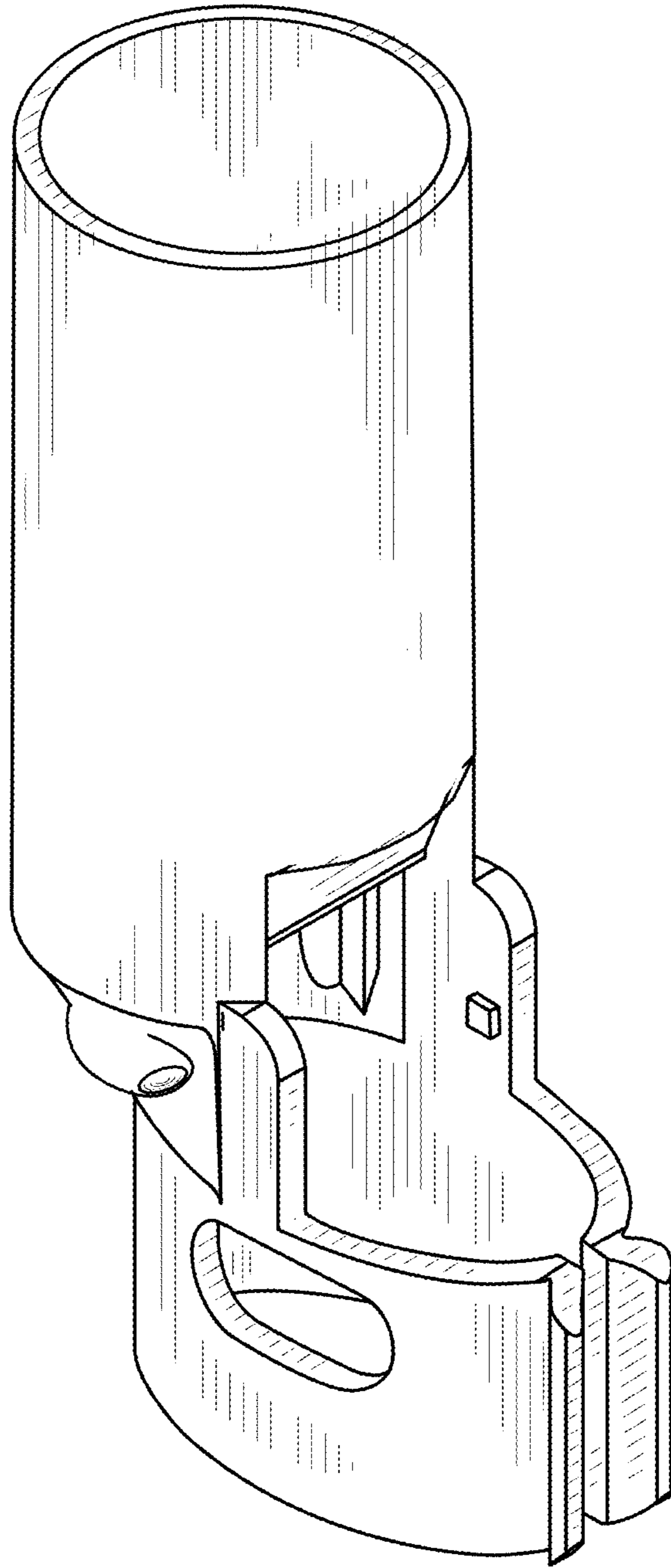

FIG. 1

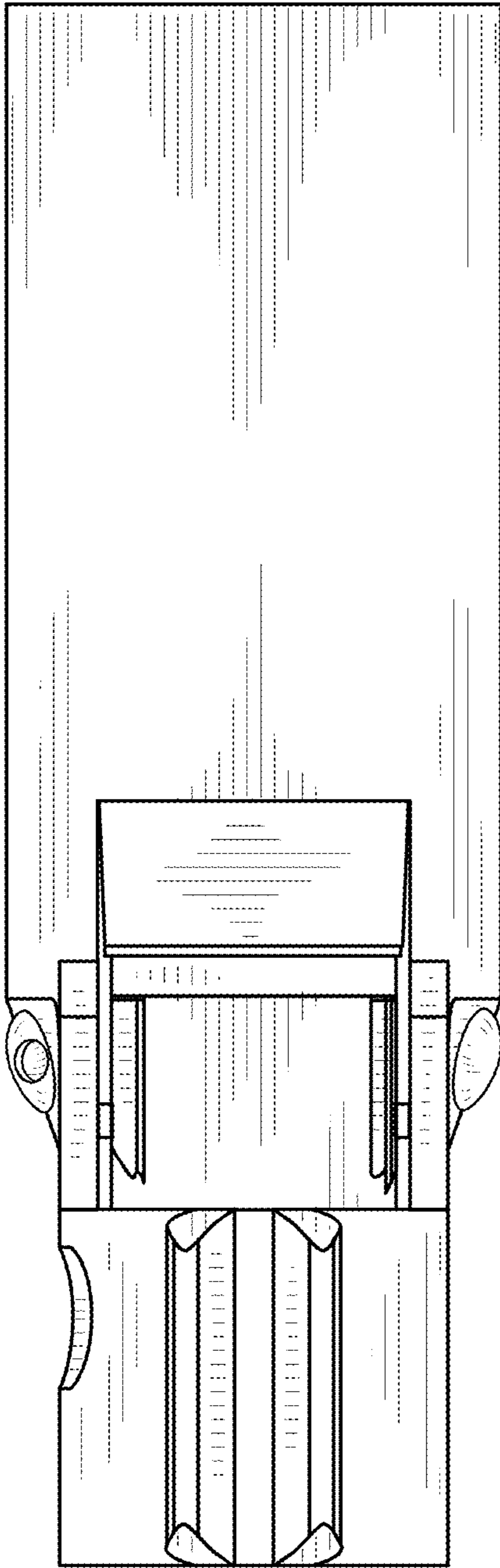

FIG. 2

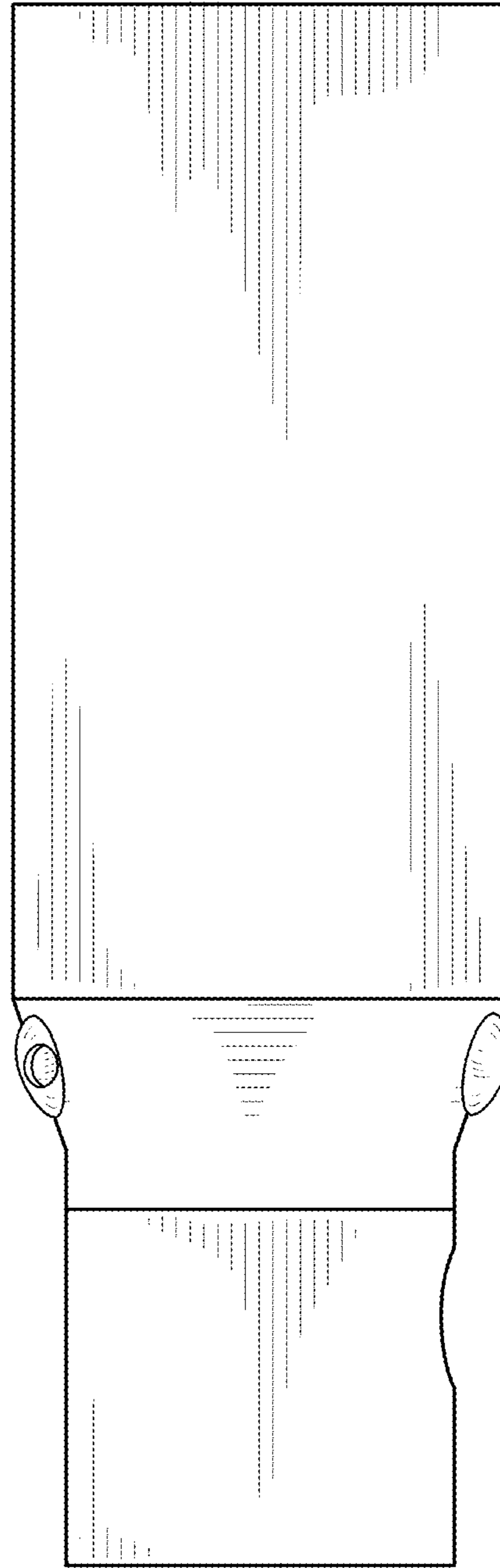

FIG. 3

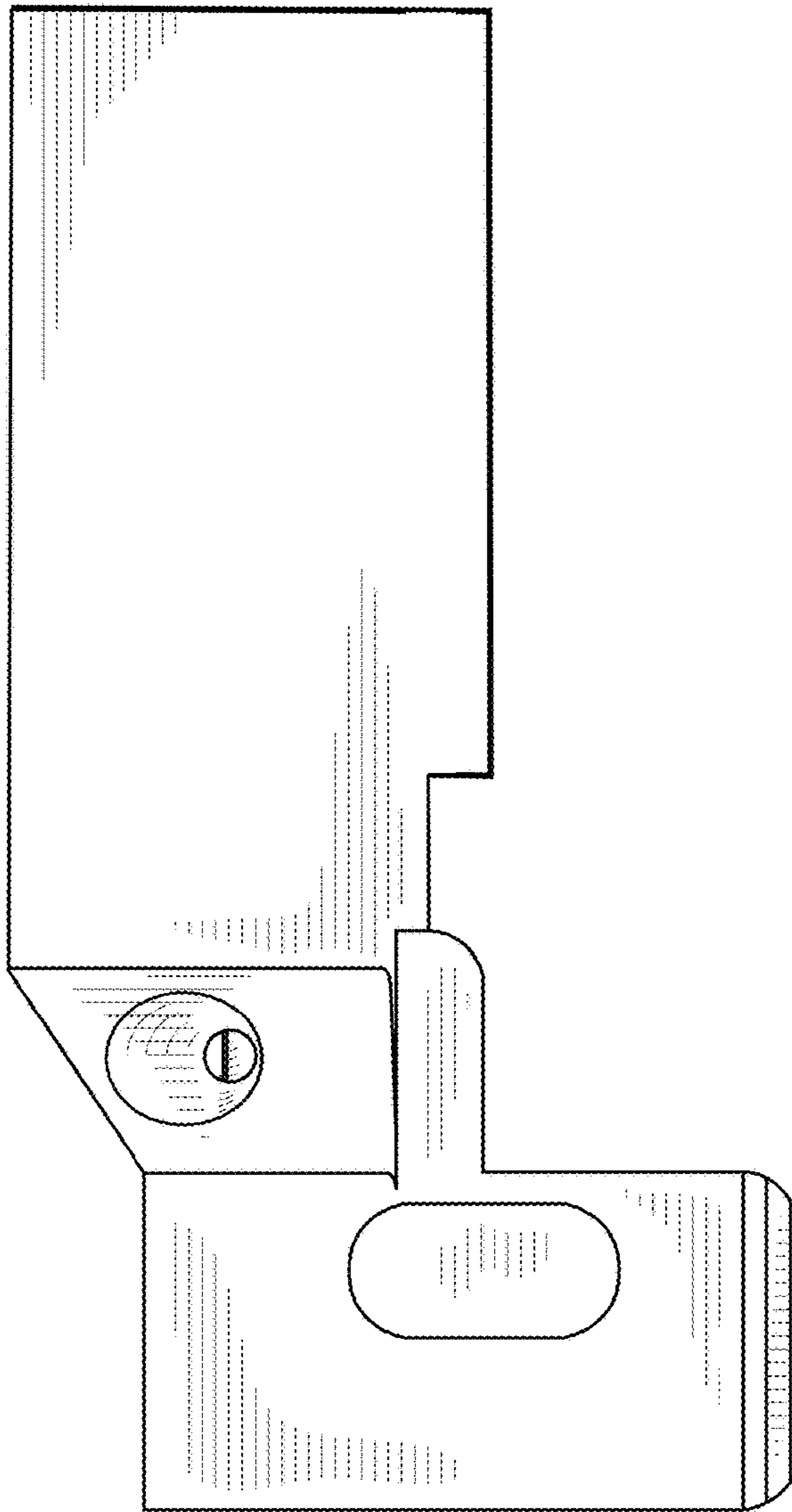

FIG. 4

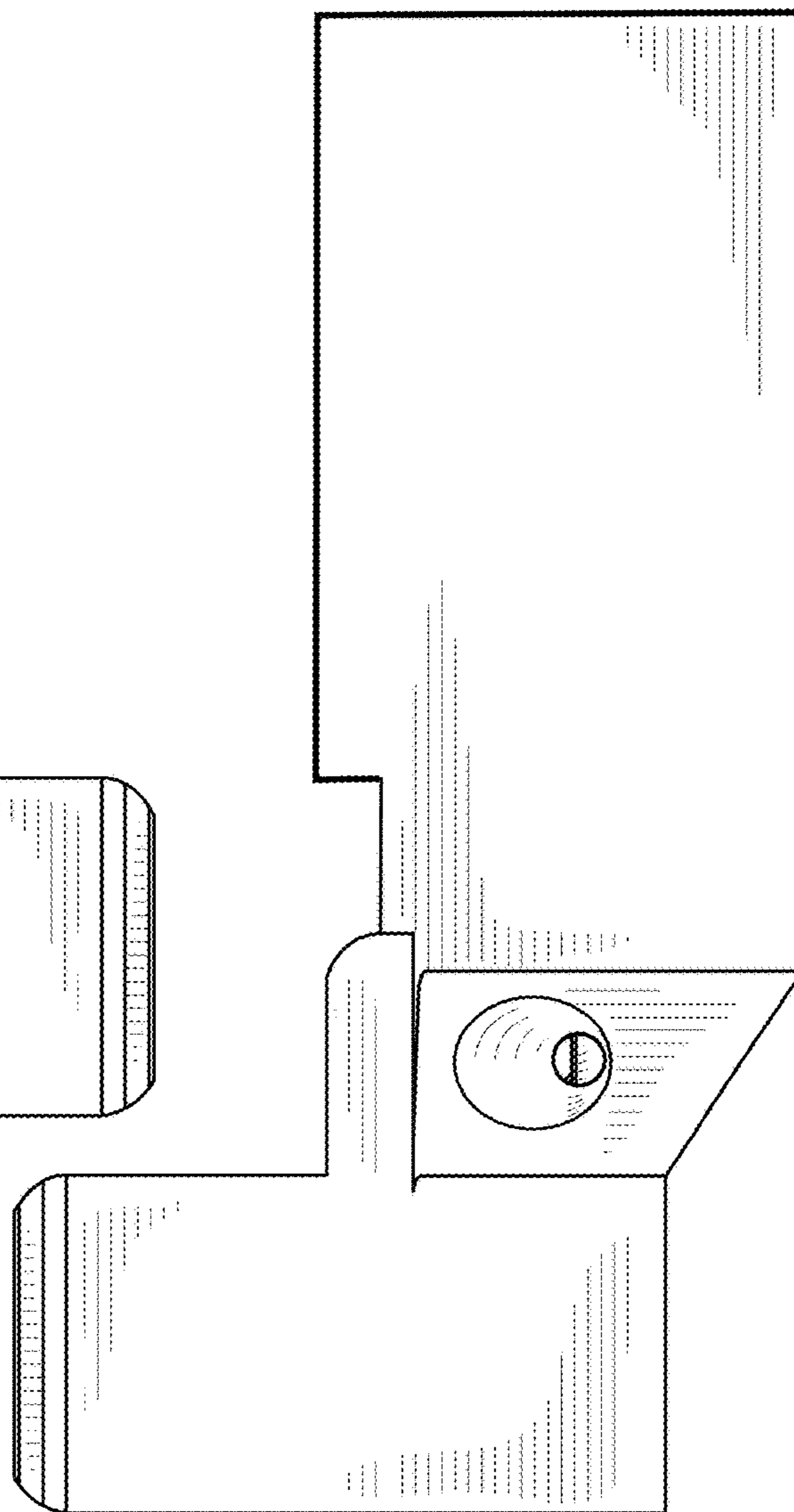

FIG. 5

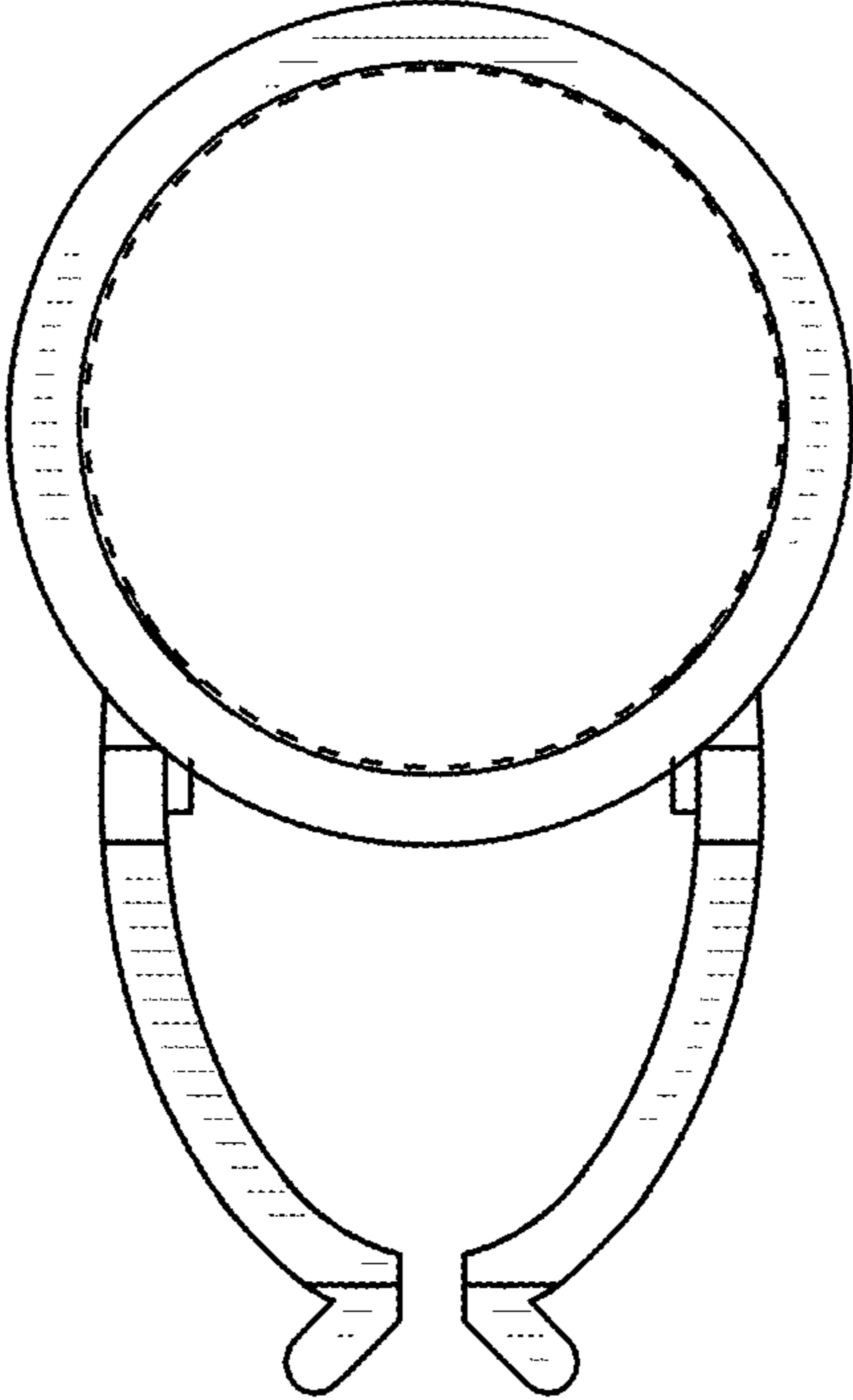

FIG. 6

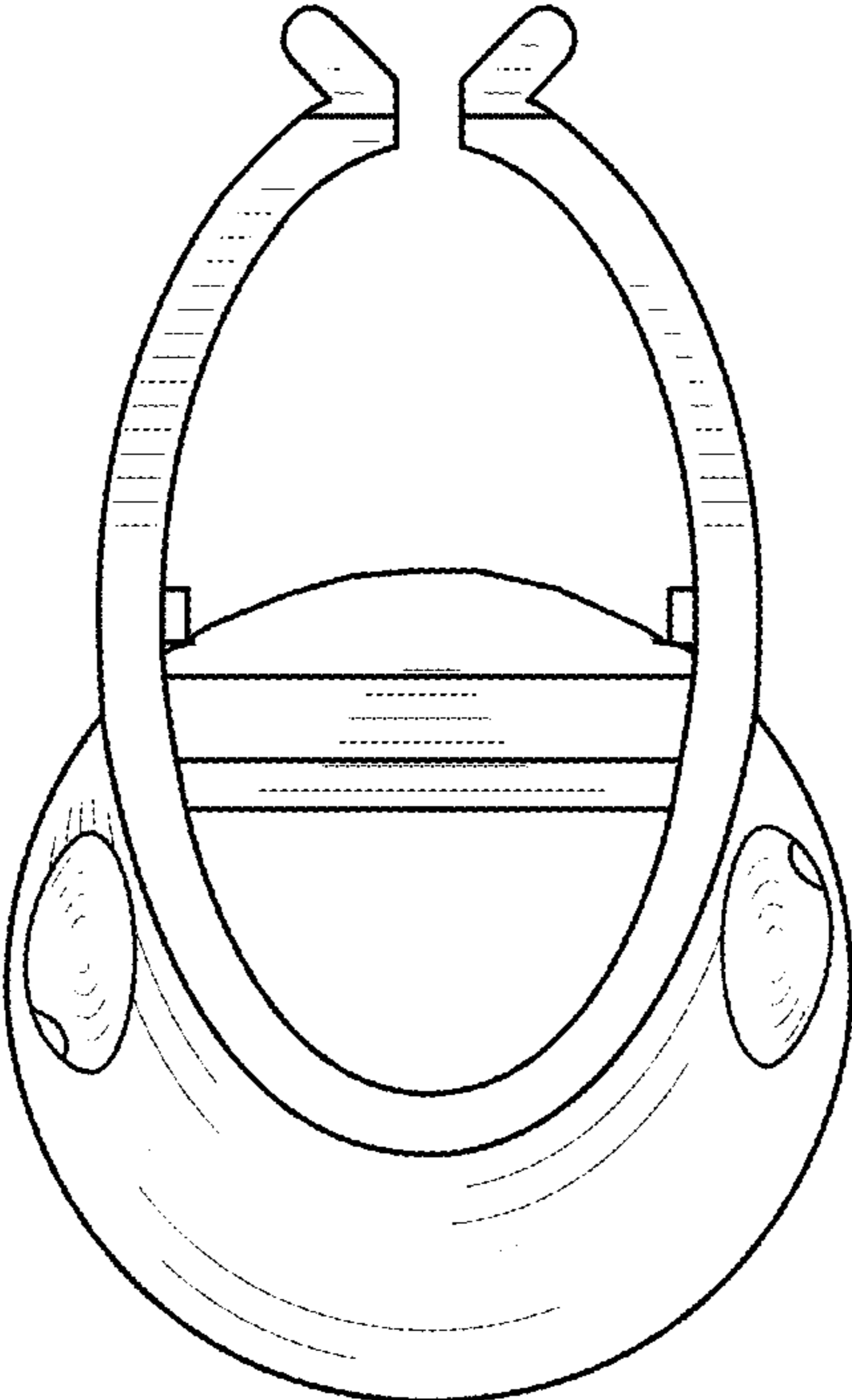

FIG. 7