



US00D783173S

(12) **United States Design Patent** (10) **Patent No.:** **US D783,173 S**
Sedic (45) **Date of Patent:** **** Apr. 4, 2017**

(54) **SKIN CLEANSER**

(71) Applicant: **Filip Sedic**, Shanghai (CN)

(72) Inventor: **Filip Sedic**, Shanghai (CN)

(**) Term: **15 Years**

(21) Appl. No.: **29/568,179**

(22) Filed: **Jun. 15, 2016**

Related U.S. Application Data

(60) Division of application No. 29/532,908, filed on Jul. 10, 2015, now Pat. No. Des. 769,455, which is a (Continued)

(30) **Foreign Application Priority Data**

Jan. 17, 2013 (CN) 2013 3 0013432
Jan. 17, 2013 (CN) 2013 3 0013435

(51) **LOC (10) Cl.** **28-03**

(52) **U.S. Cl.**
USPC **D24/215**

(58) **Field of Classification Search**
USPC D24/200, 211, 212, 213, 214, 215;
601/114, 120, 121, 124, 125, 130, 131,
601/134, 135, 136, 137
(Continued)

(56) **References Cited**

U.S. PATENT DOCUMENTS

D351,474 S * 10/1994 Huang D24/211
D369,220 S * 4/1996 Huang D24/215
(Continued)

Primary Examiner — Sandra Snapp

(74) *Attorney, Agent, or Firm* — Fenwick & West LLP

(57) **CLAIM**

I claim the ornamental design for a skin cleanser, as shown and described.

DESCRIPTION

FIG. 1 is a front view of a first embodiment of a skin cleanser.

FIG. 2 is a right side view of the first embodiment of the skin cleanser.

FIG. 3 is a rear view of the first embodiment of the skin cleanser.

FIG. 4 is a left side view of the first embodiment of the skin cleanser.

FIG. 5 is a top view of the first embodiment of the skin cleanser.

FIG. 6 is a bottom view of the first embodiment of the skin cleanser.

FIGS. 7 and 8 are perspective views of the first embodiment of the skin cleanser.

FIG. 9 is a front view of a second embodiment of the skin cleanser.

FIG. 10 is a right side view of the second embodiment of the skin cleanser.

FIG. 11 is a rear view of the second embodiment of the skin cleanser.

FIG. 12 is a left side view of the second embodiment of the skin cleanser.

FIG. 13 is a top view of the second embodiment of the skin cleanser.

FIG. 14 is a bottom view of the second embodiment of the skin cleanser.

FIGS. 15 and 16 are perspective views of the second embodiment of the skin cleanser.

FIG. 17 is a front view of a third embodiment of the skin cleanser.

FIG. 18 is a right side view of the third embodiment of the skin cleanser.

FIG. 19 is a rear view of the third embodiment of the skin cleanser.

FIG. 20 is a left side view of the third embodiment of the skin cleanser.

FIG. 21 is a top view of the third embodiment of the skin cleanser.

FIG. 22 is a bottom view of the third embodiment of the skin cleanser.

FIGS. 23 and 24 are perspective views of the third embodiment of the skin cleanser.

FIG. 25 is a front view of a fourth embodiment of the skin cleanser.

(Continued)

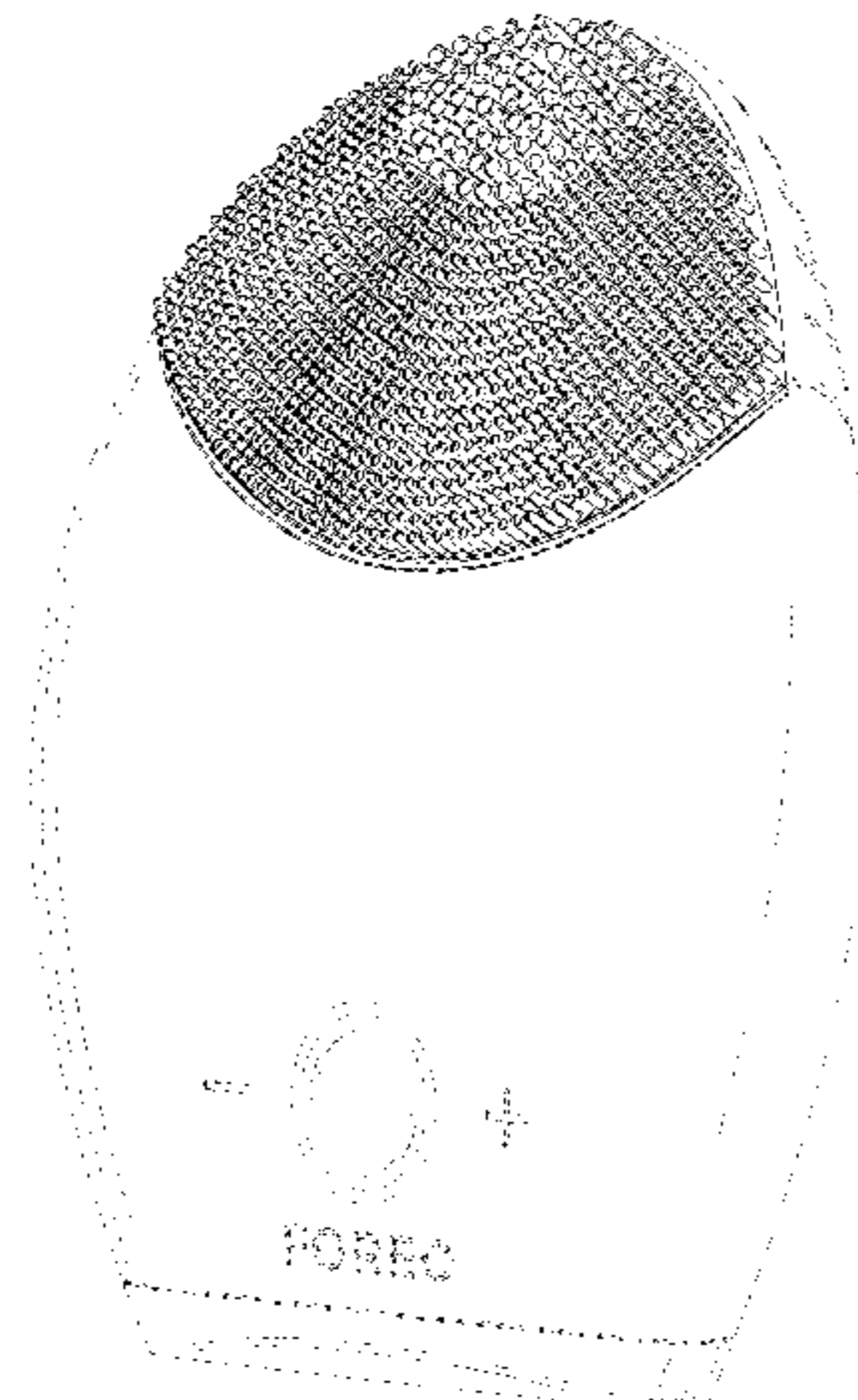

FIG. 26 is a right side view of the fourth embodiment of the skin cleanser.
 FIG. 27 is a rear view of the fourth embodiment of the skin cleanser.
 FIG. 28 is a left side view of the fourth embodiment of the skin cleanser.
 FIG. 29 is a top view of the fourth embodiment of the skin cleanser.
 FIG. 30 is a bottom view of the fourth embodiment of the skin cleanser.
 FIGS. 31 and 32 are perspective views of the fourth embodiment of the skin cleanser.
 FIG. 33 is a front view of a fifth embodiment of the skin cleanser.
 FIG. 34 is a right side view of the fifth embodiment of the skin cleanser.
 FIG. 35 is a rear view of the fifth embodiment of the skin cleanser.
 FIG. 36 is a left side view of the fifth embodiment of the skin cleanser.
 FIG. 37 is a top view of the fifth embodiment of the skin cleanser.
 FIG. 38 is a bottom view of the fifth embodiment of the skin cleanser; and,
 FIGS. 39 and 40 are perspective views of the fifth embodiment of the skin cleanser.
 The broken lines are directed to environment and are for illustrative purposes only; the broken lines form no part of the claimed design.

1 Claim, 35 Drawing Sheets

Related U.S. Application Data

continuation of application No. 29/508,139, filed on Nov. 3, 2014, now Pat. No. Des. 734,481, which is a

continuation of application No. 29/480,166, filed on Jan. 23, 2014, now Pat. No. Des. 716,961, which is a continuation of application No. 29/457,890, filed on Jun. 13, 2013, now Pat. No. Des. 698,455.

(58) **Field of Classification Search**

CPC A61H 19/30; A61H 19/32; A61H 19/34; A61H 19/40; A61H 19/44; A61H 19/50; A61H 19/00; A61H 2201/0153; A61H 2201/0207; A61H 2201/0263; A61H 2201/0111; A61H 2201/1253; A61H 2205/082; A61H 2205/085; A61H 15/0085

See application file for complete search history.

(56) **References Cited**

U.S. PATENT DOCUMENTS

D423,109	S	*	4/2000	Allende	D24/215
D466,217	S	*	11/2002	Harris	D24/215
D476,087	S	*	6/2003	Dirks	D24/215
D517,218	S	*	3/2006	Kalen	D24/215
D539,917	S	*	4/2007	Park	D24/215
D548,815	S	*	8/2007	Frisell	D23/207
D548,851	S	*	8/2007	Huang	D24/214
D571,926	S	*	6/2008	Wu	D24/215
D576,736	S	*	9/2008	Hagege	D24/215
D622,405	S	*	8/2010	Tuli	D24/213
D626,656	S	*	11/2010	Jarry	D24/215
D645,569	S	*	9/2011	Nitsch	D24/215
D674,108	S	*	1/2013	York	D24/215
D698,455	S	*	1/2014	Sedic	A61H 23/004 D24/215
D715,935	S	*	10/2014	Huntington	D24/146
D716,961	S	*	11/2014	Sedic	A61H 23/004 D24/215
D734,481	S	*	7/2015	Sedic	A61H 23/004 D24/215
D769,455	S	*	10/2016	Sedic	A61H 23/004 D24/218

* cited by examiner

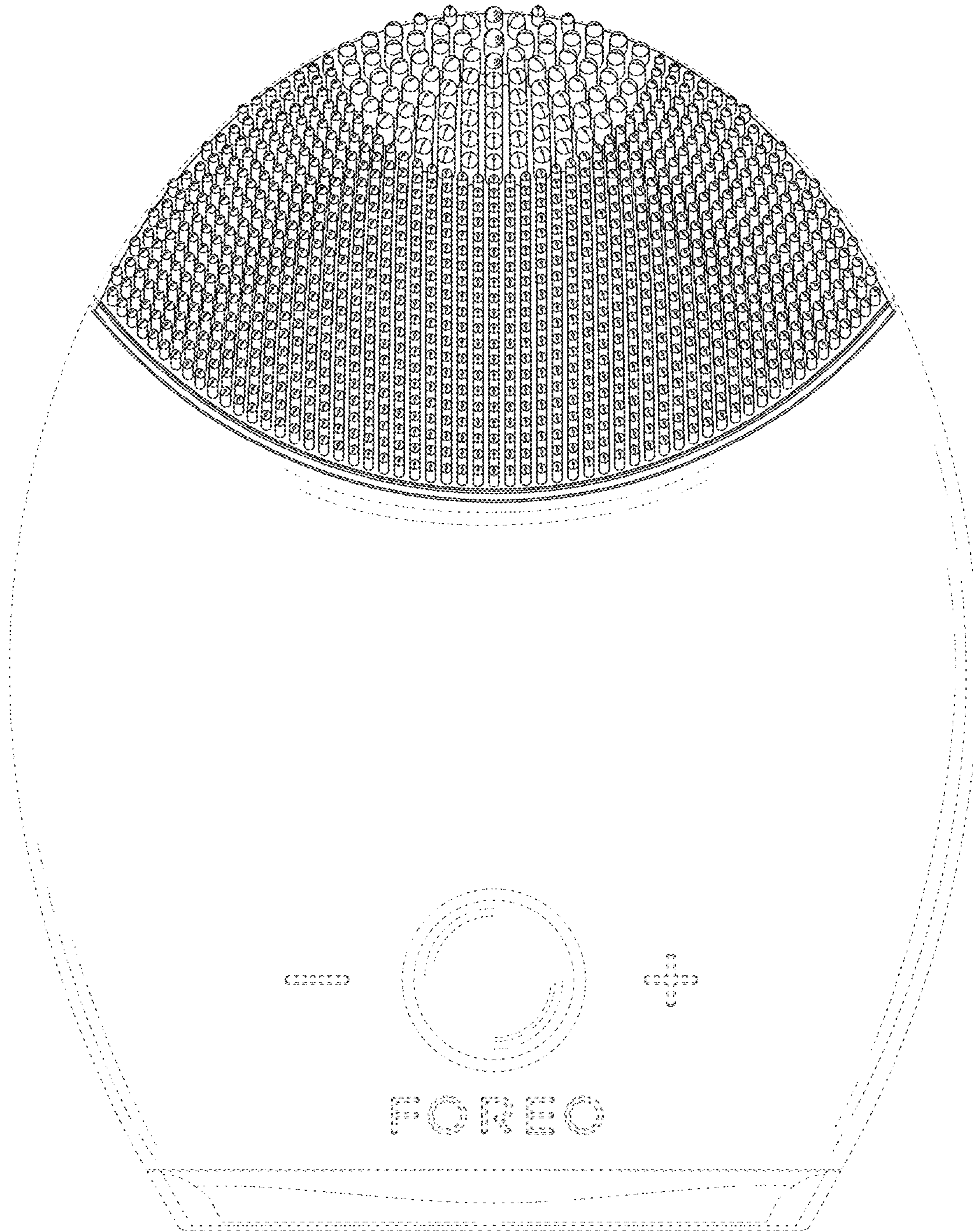

FIG. 1

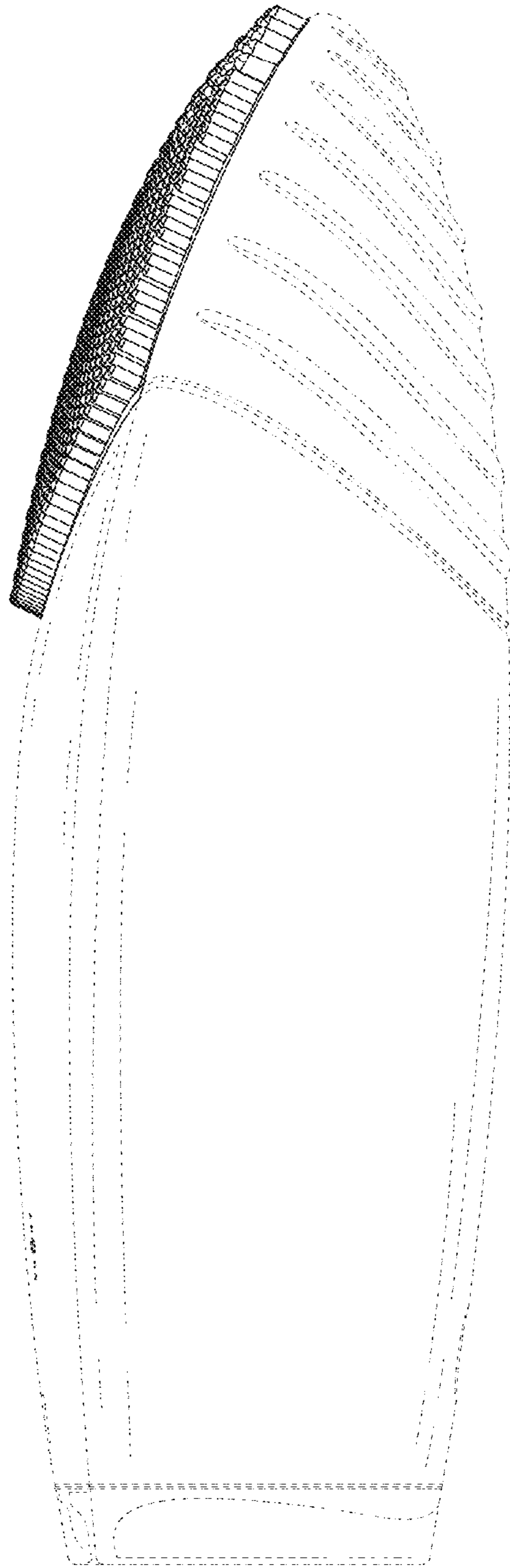

FIG. 2

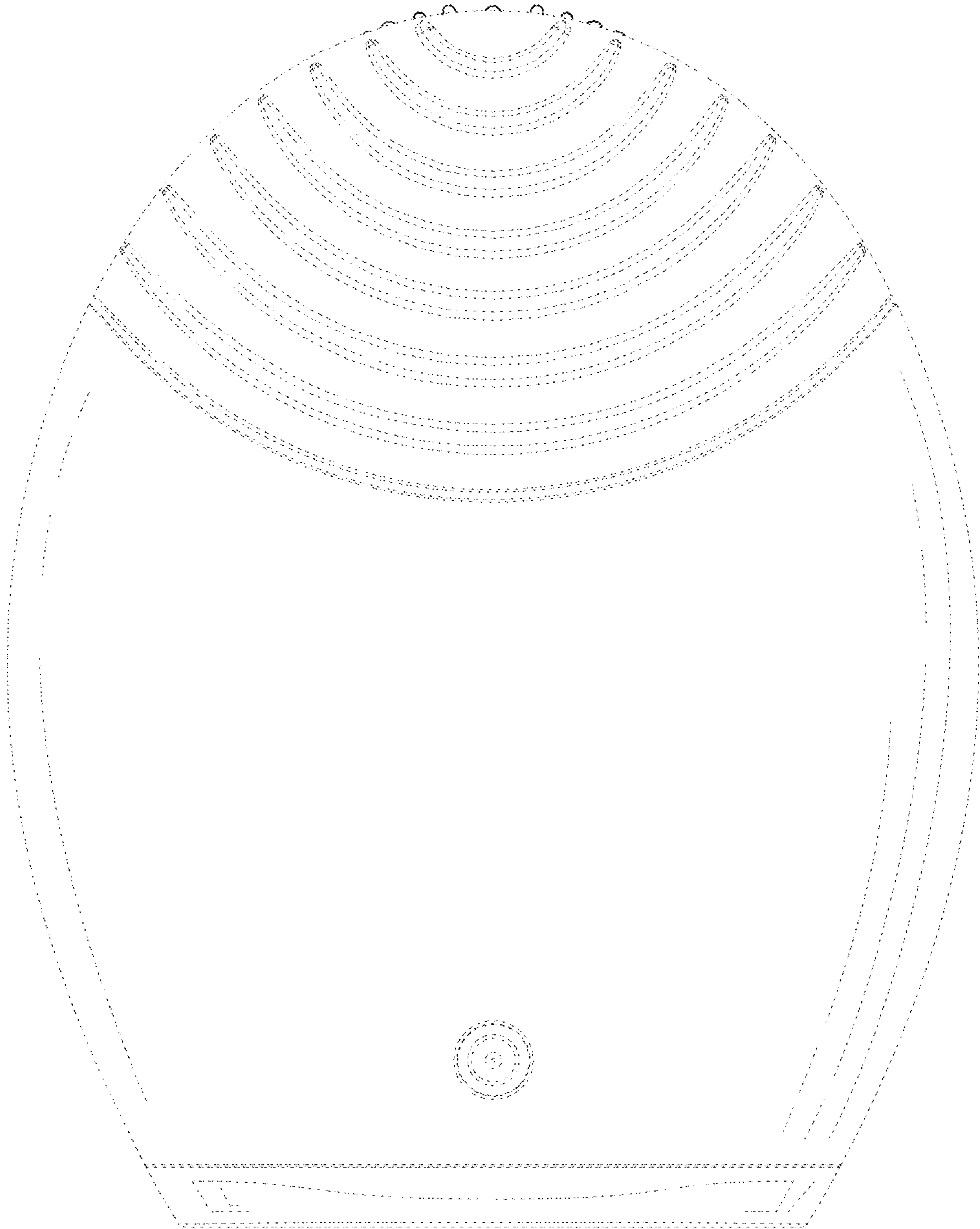

FIG. 3

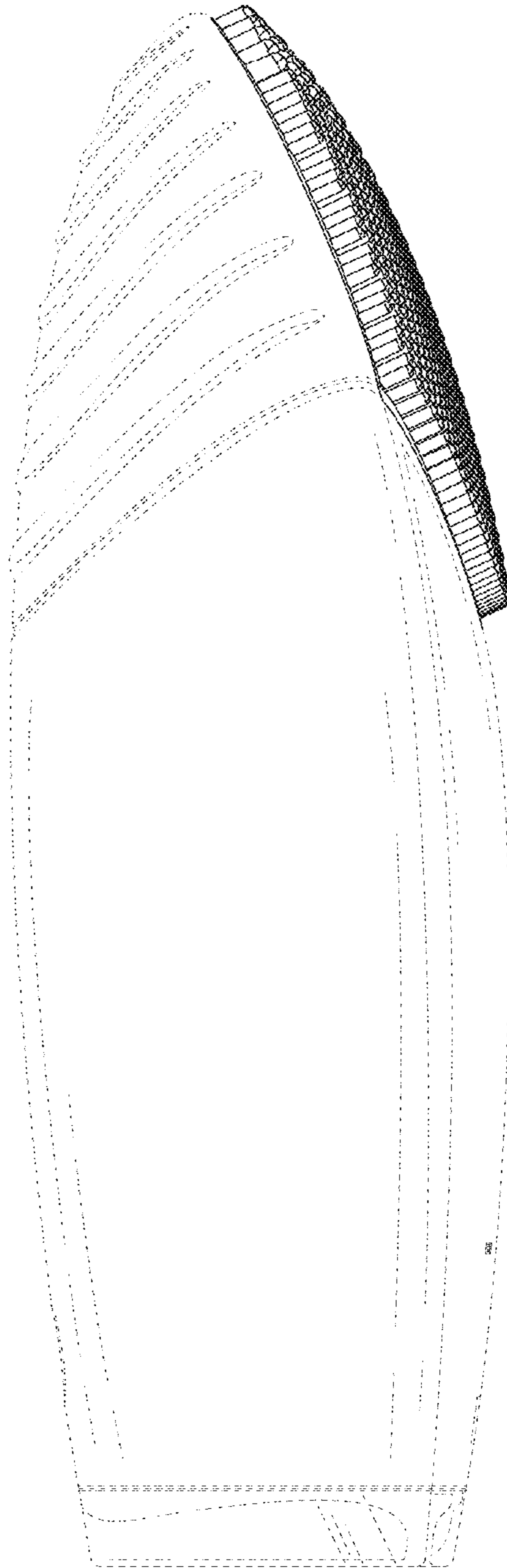

FIG. 4

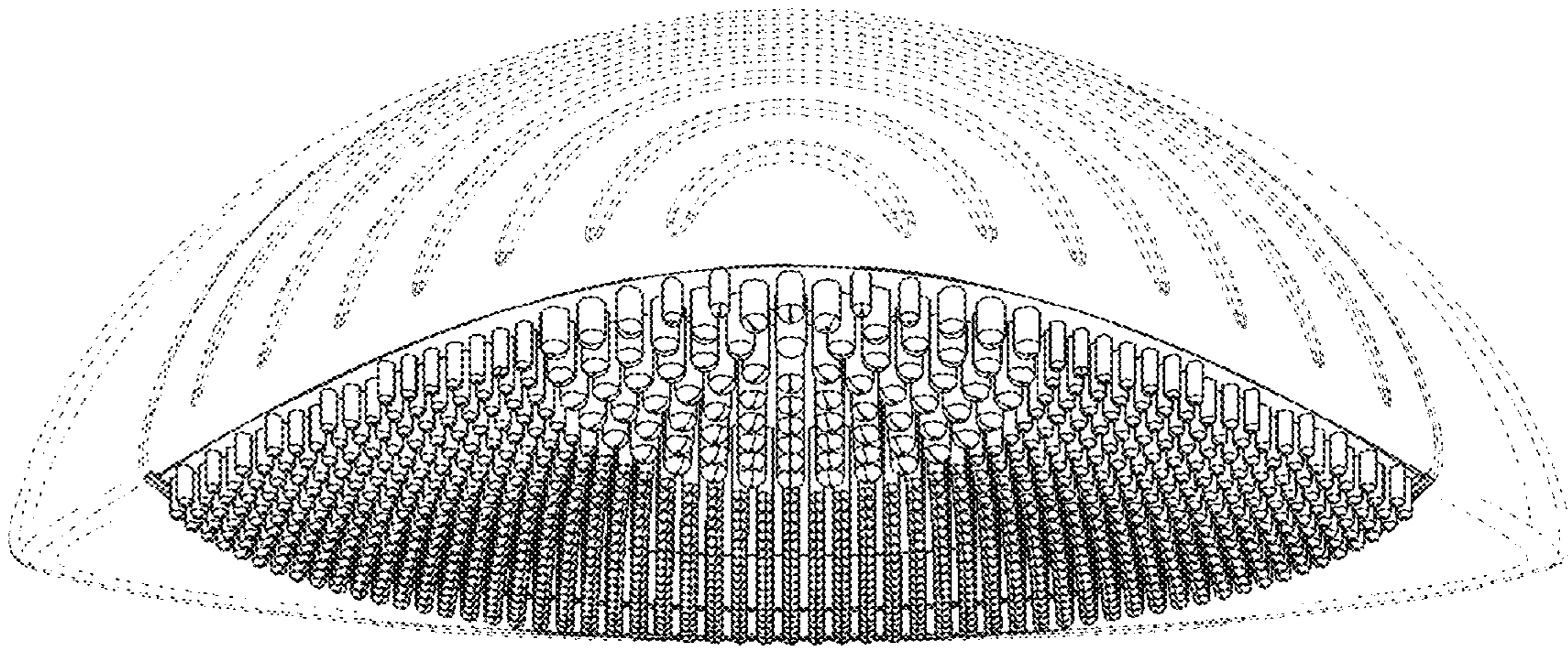

FIG. 5

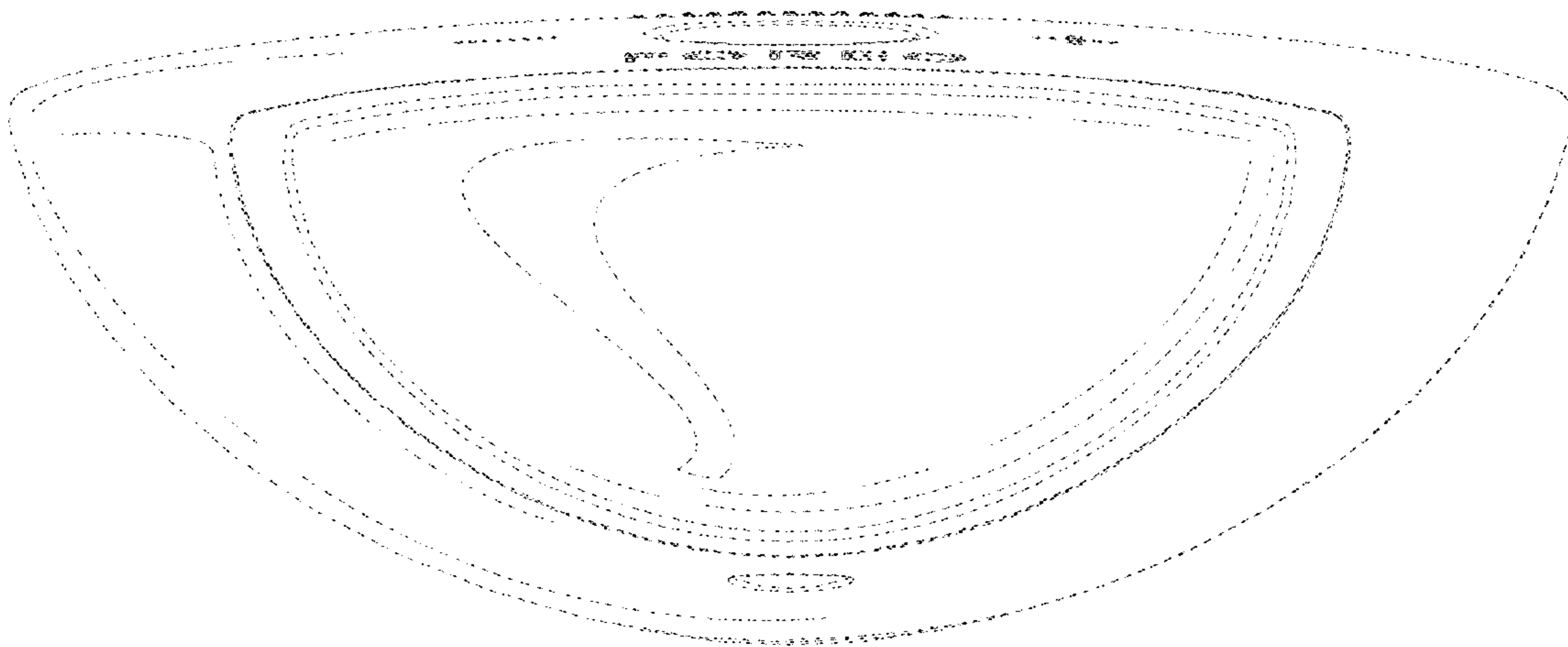

FIG. 6

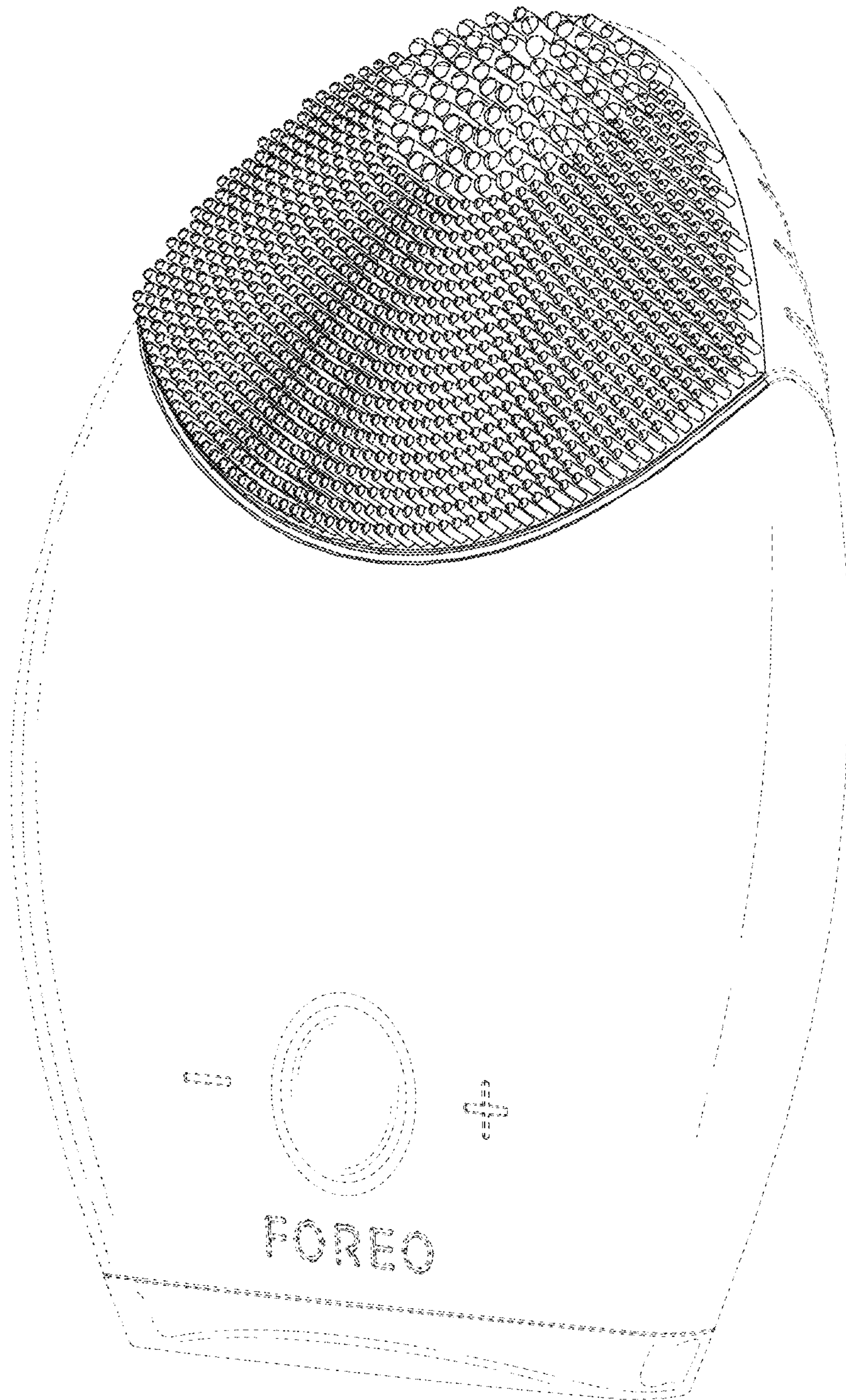

FIG. 7

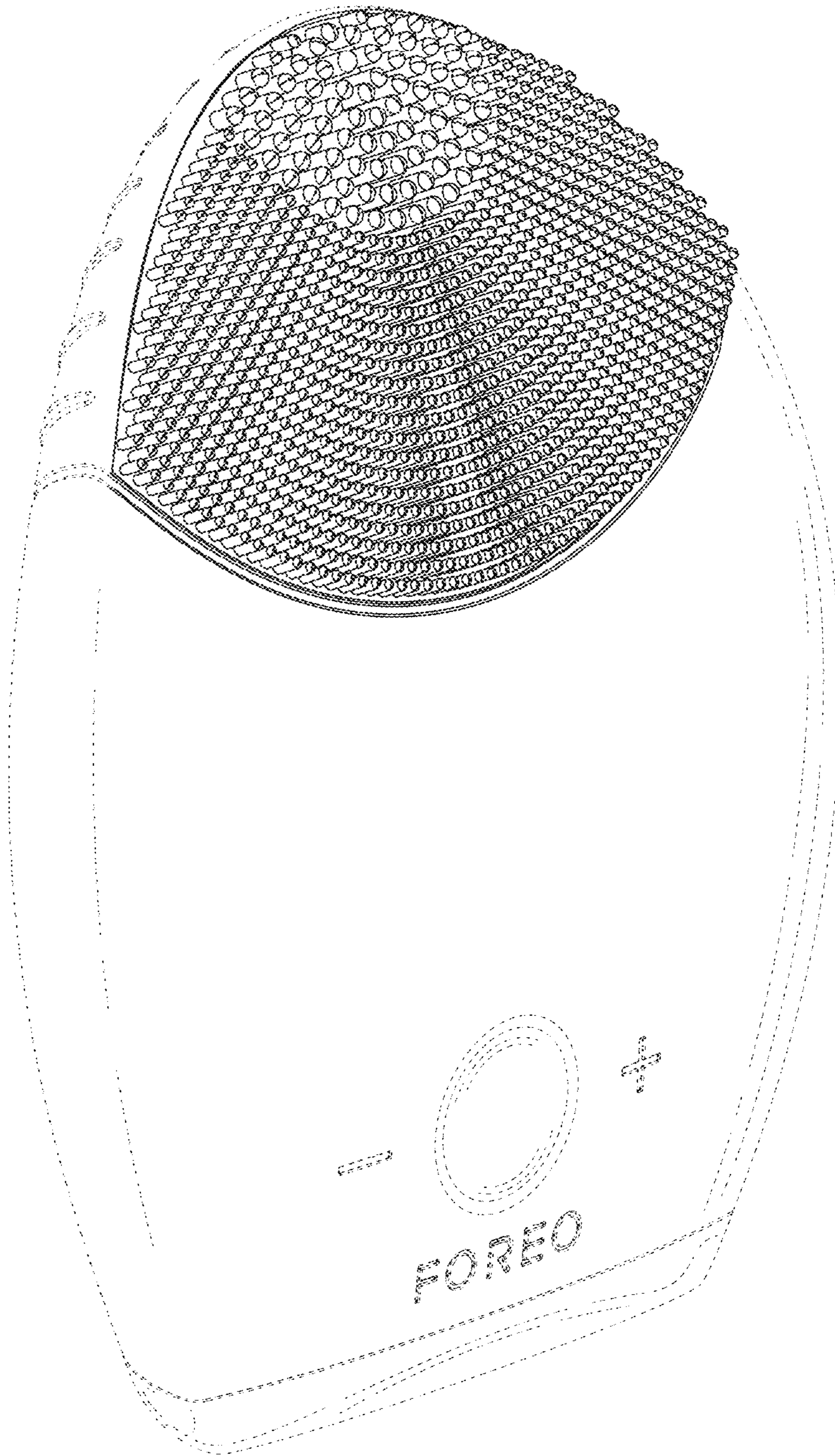

FIG. 8

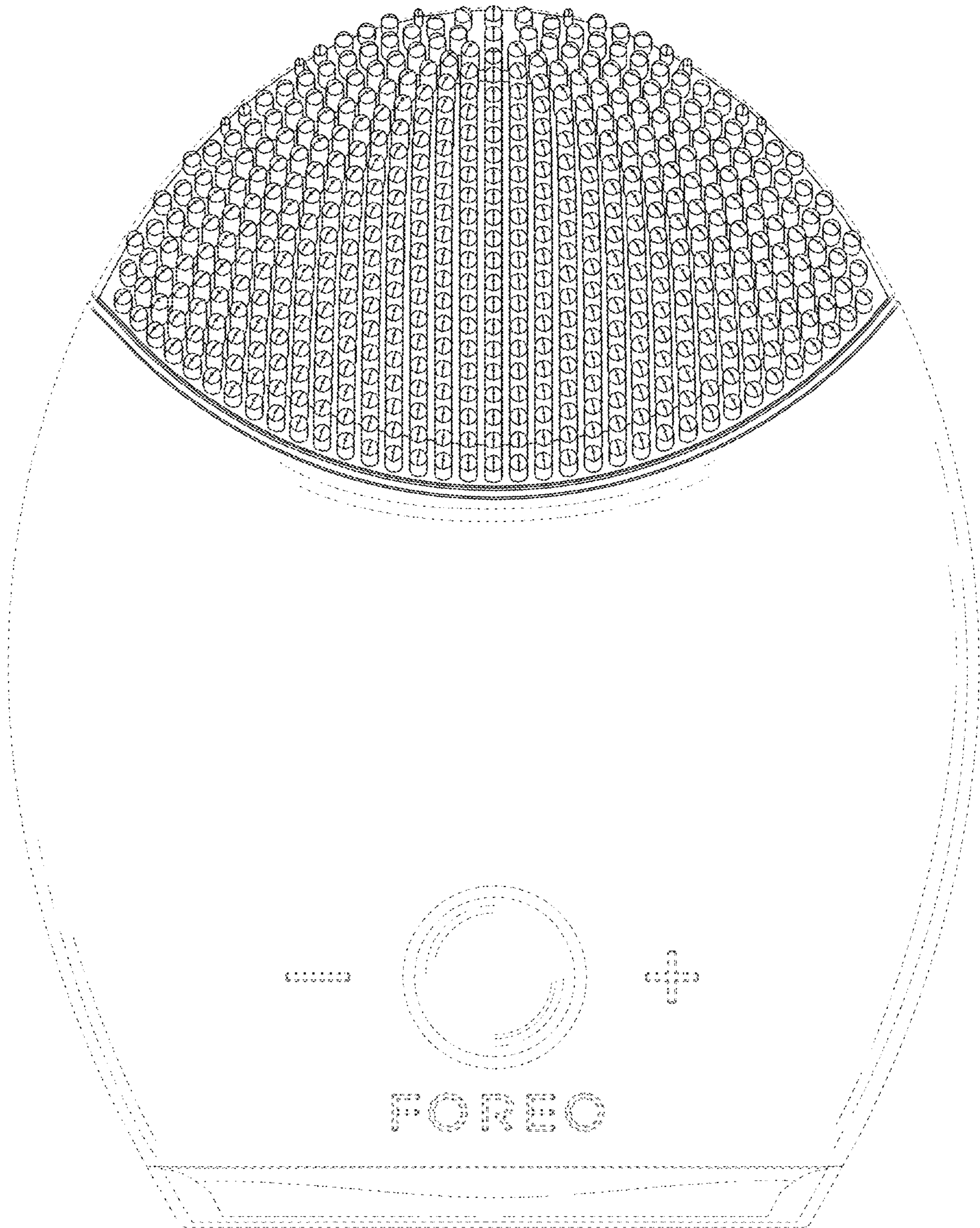

FIG. 9

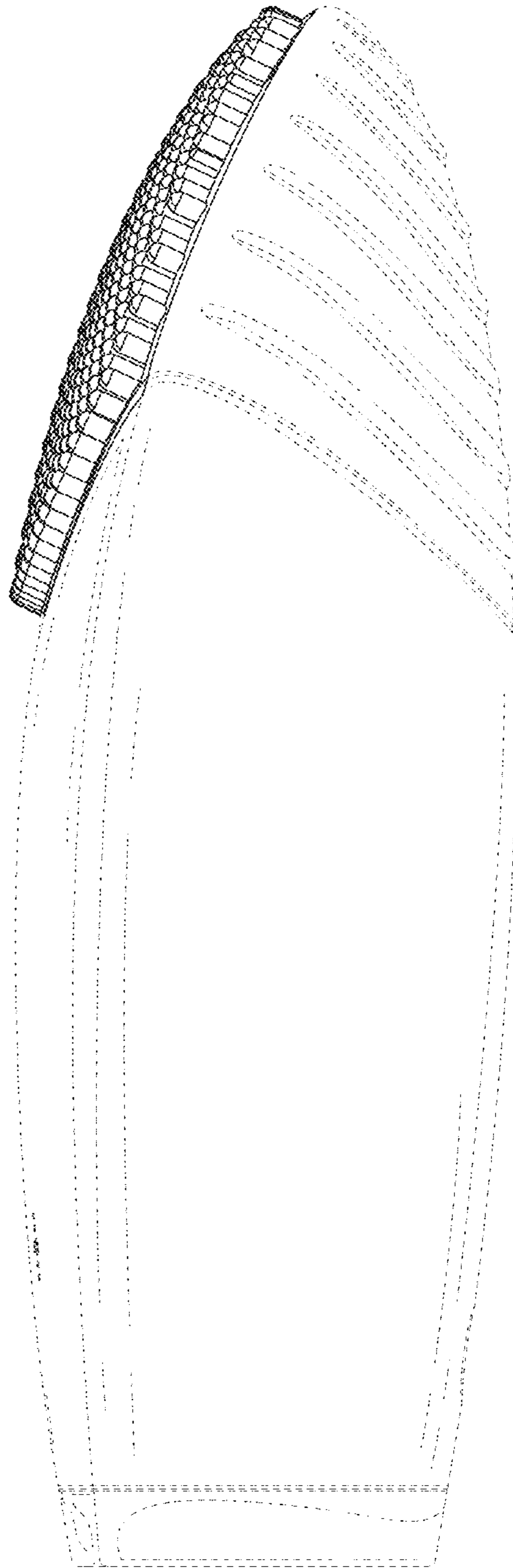

FIG. 10

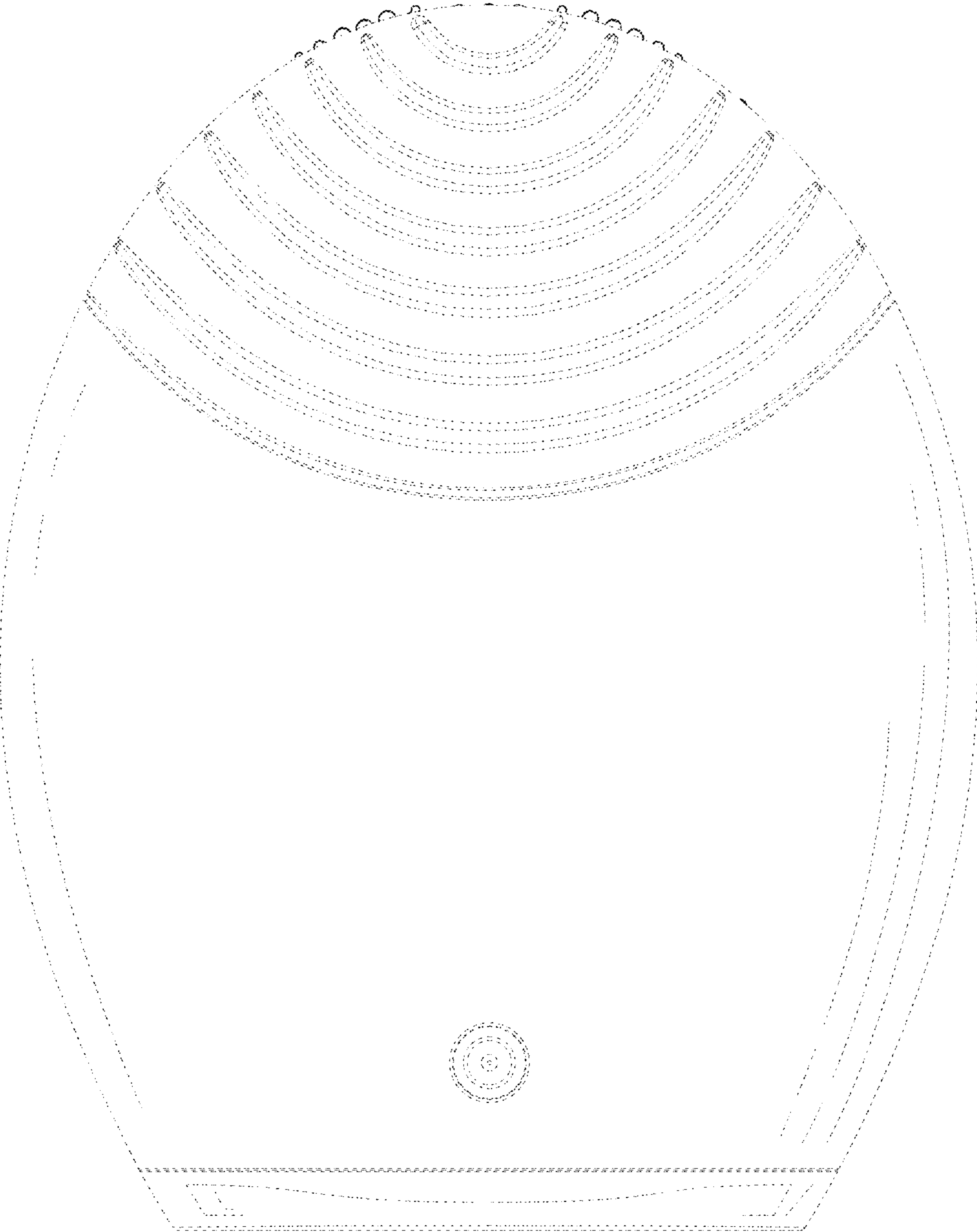

FIG. 11

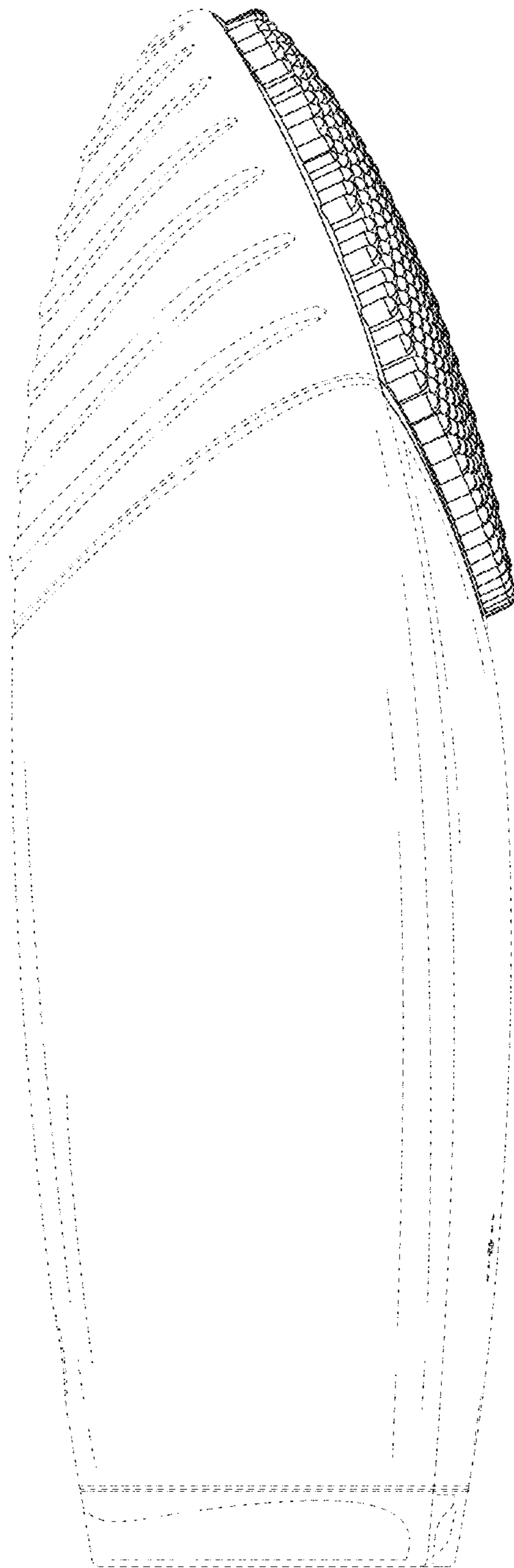

FIG. 12

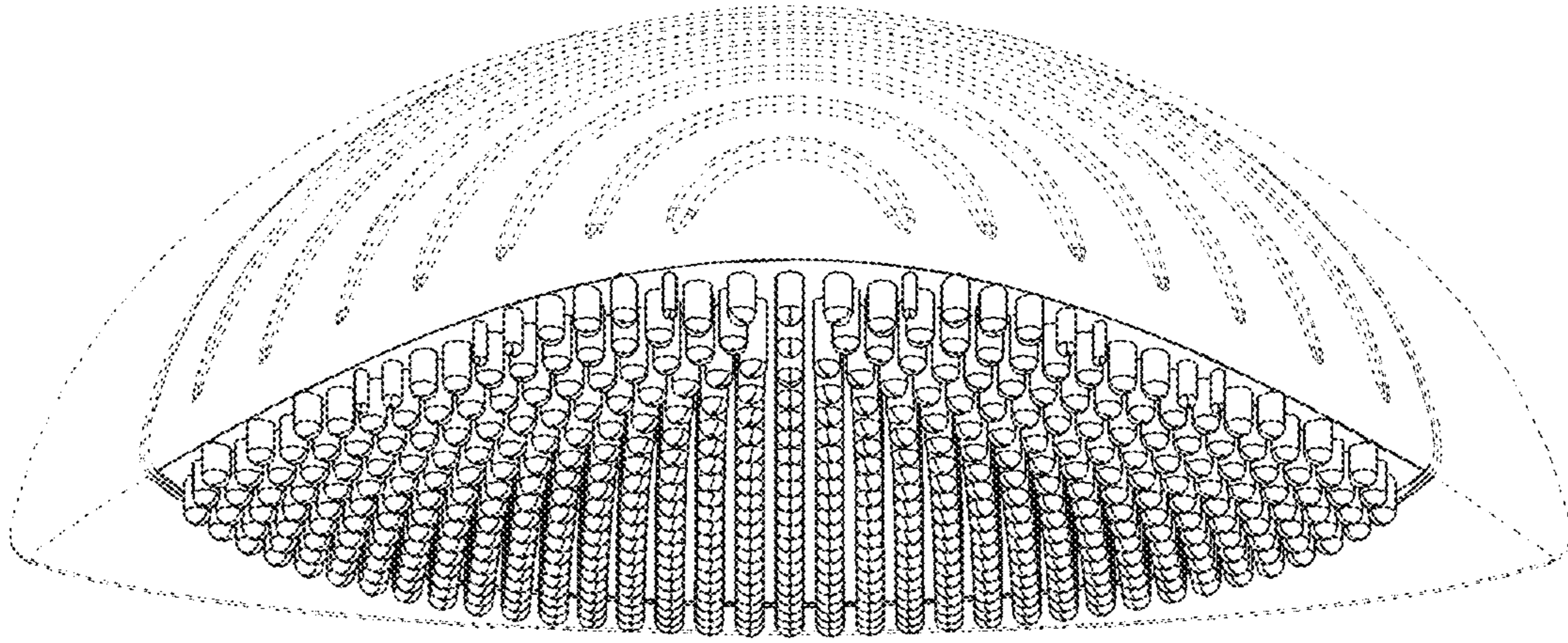

FIG. 13

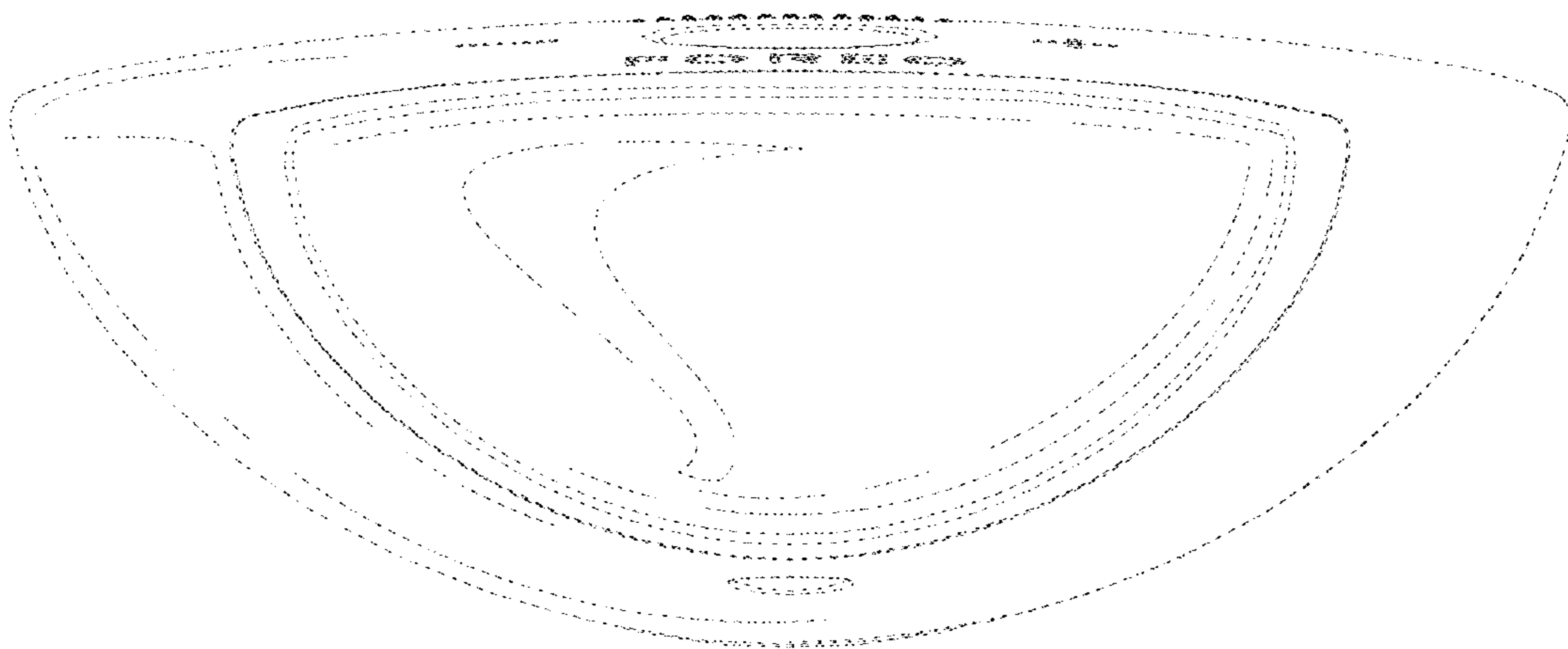

FIG. 14

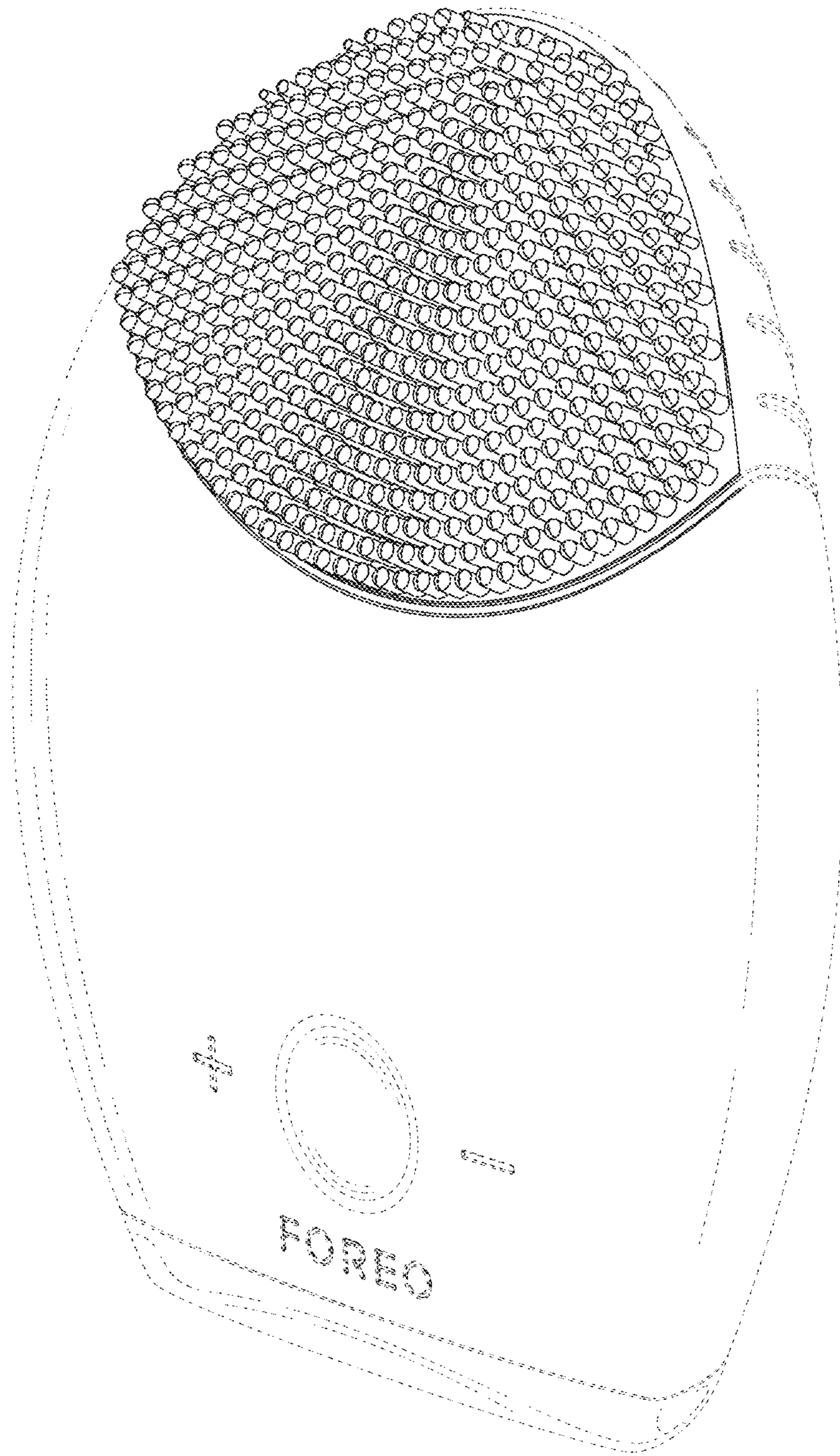

FIG. 15

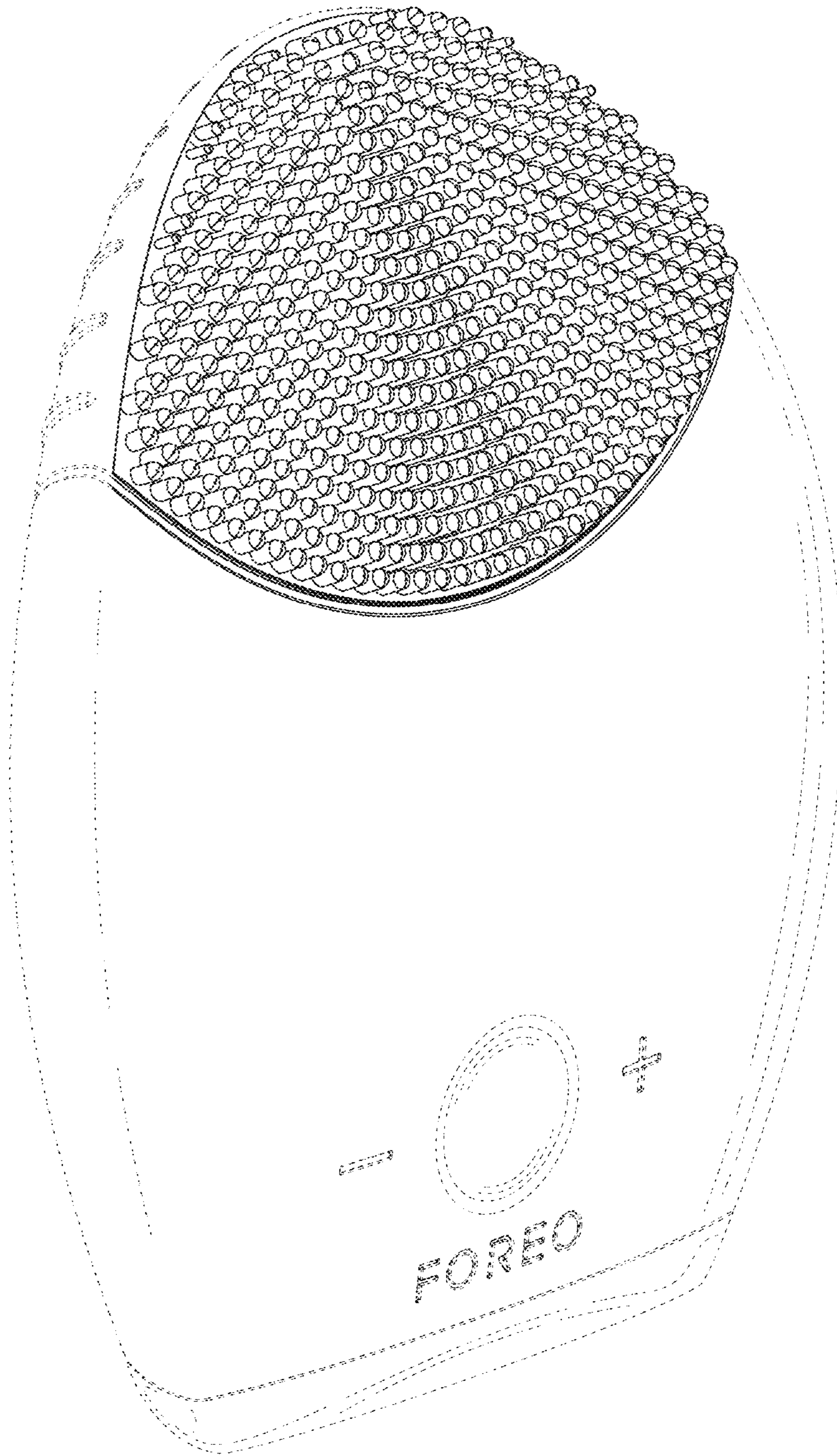

FIG. 16

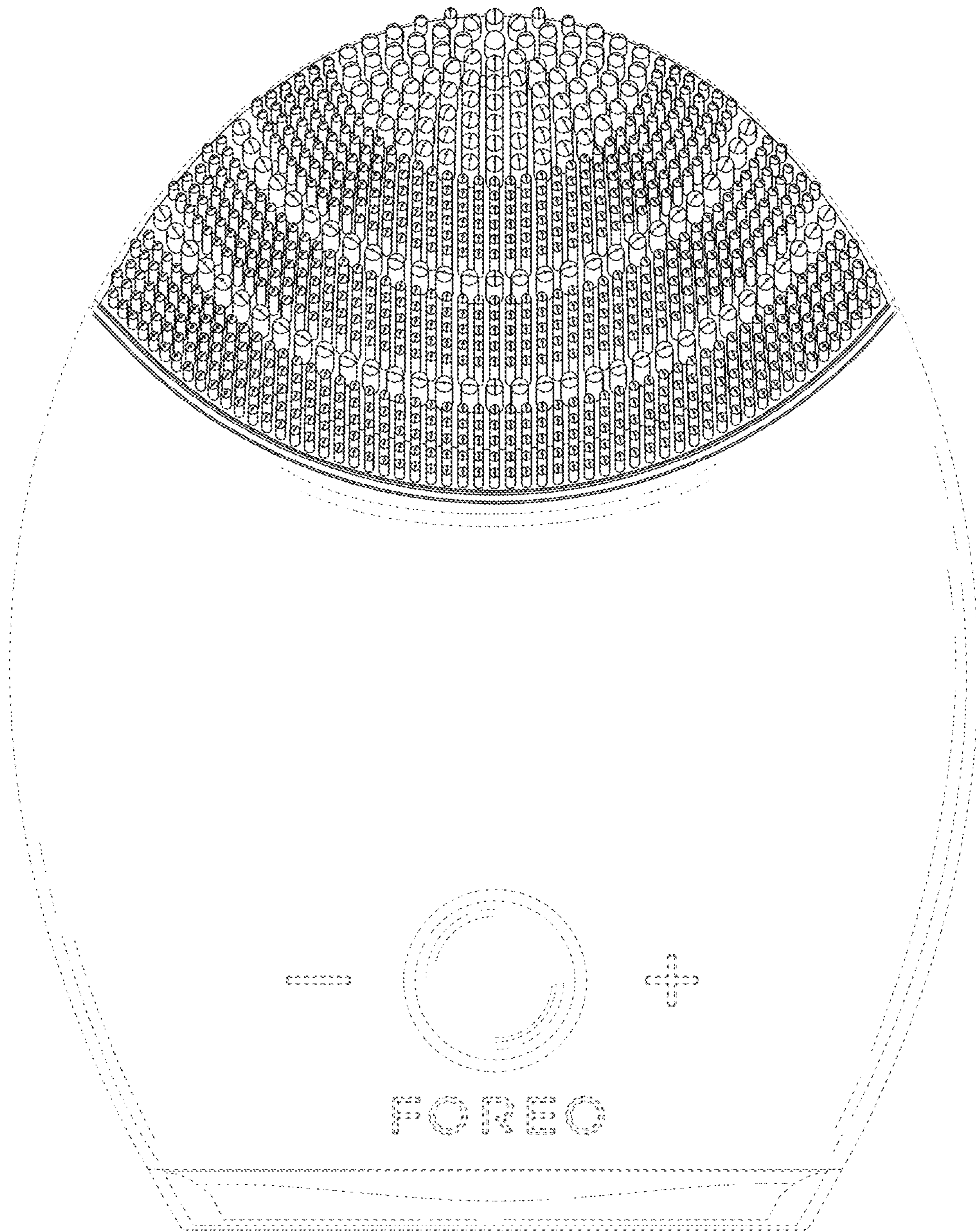

FIG. 17

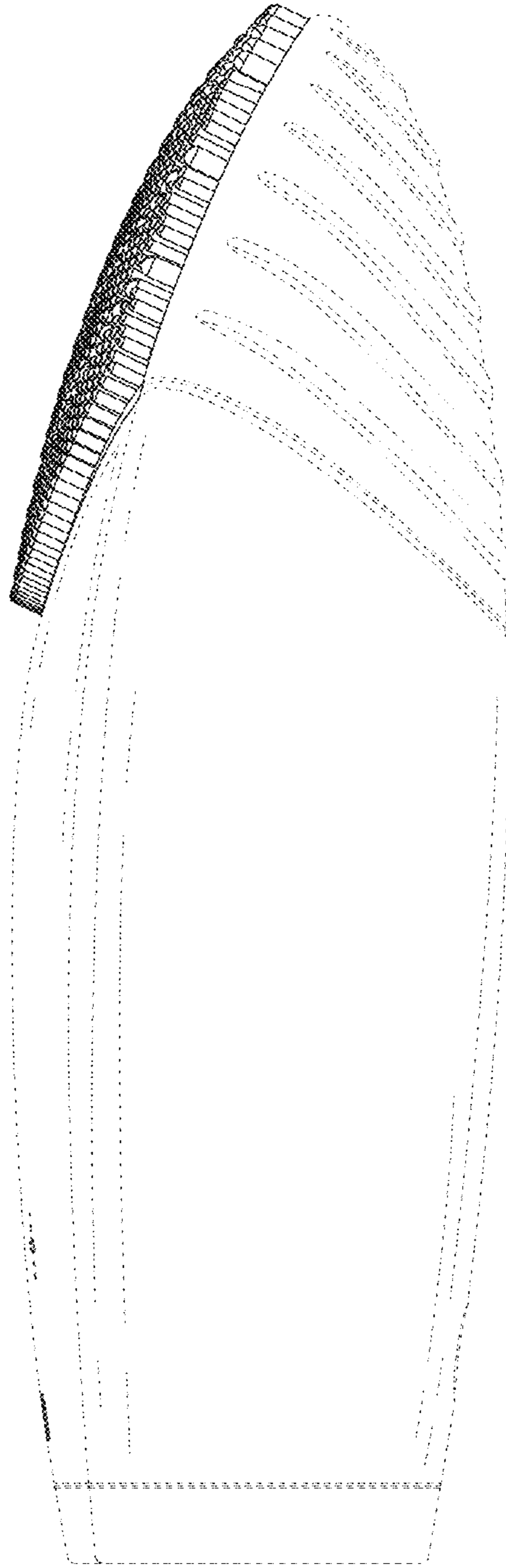

FIG. 18

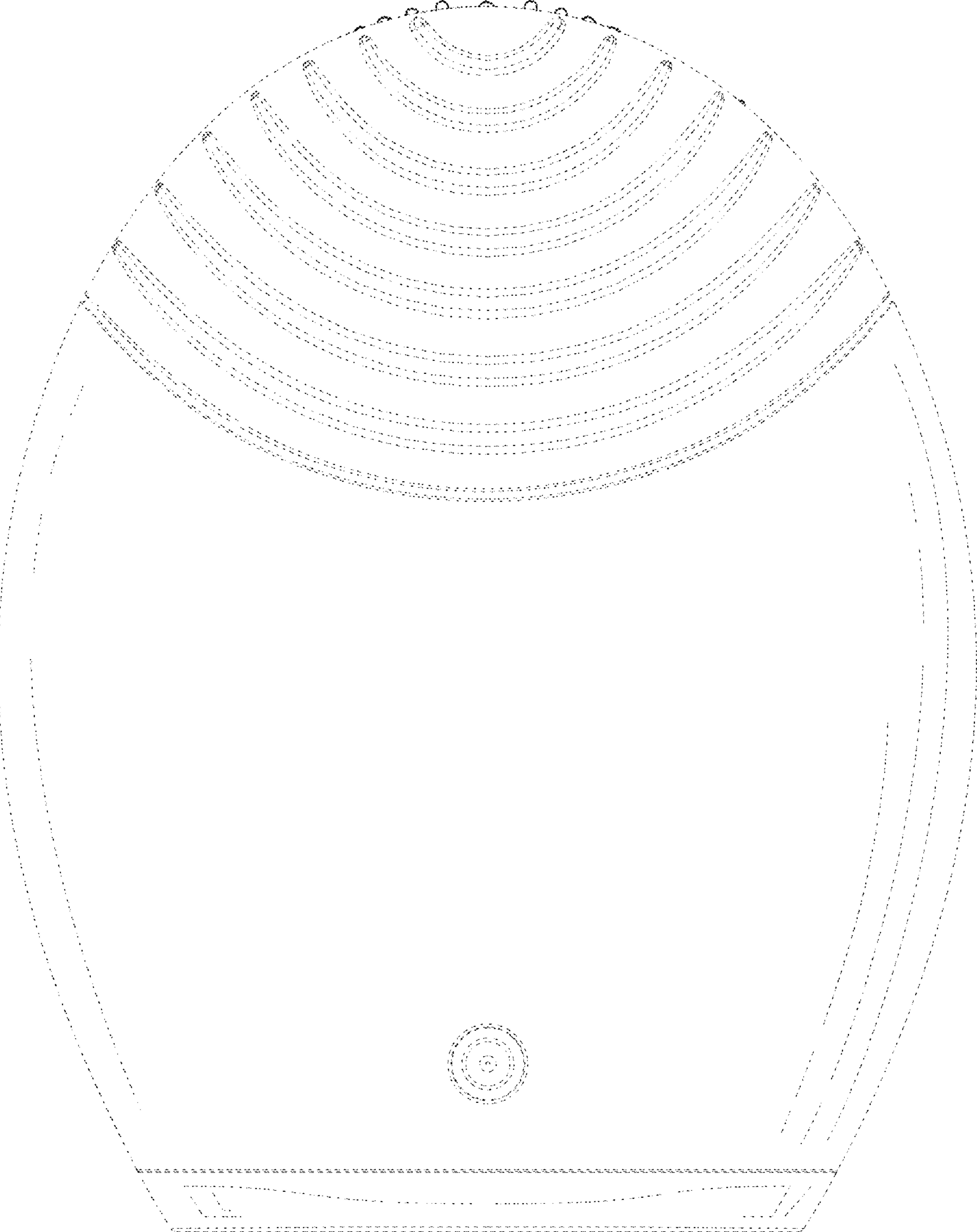

FIG. 19

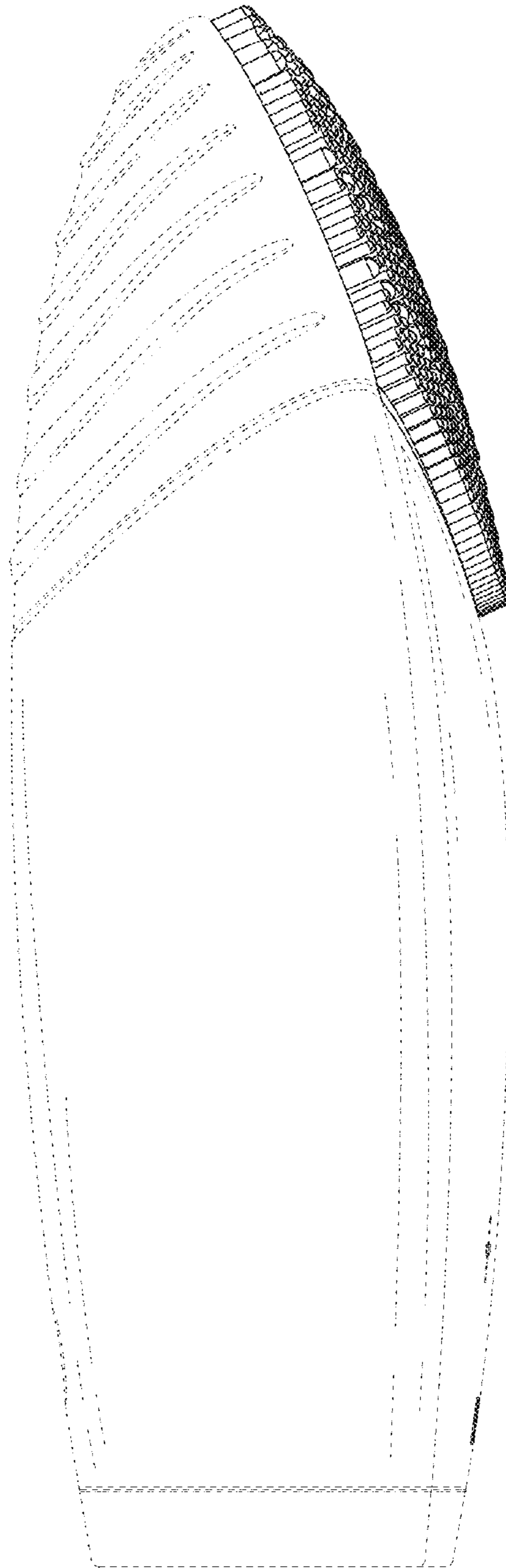

FIG. 20

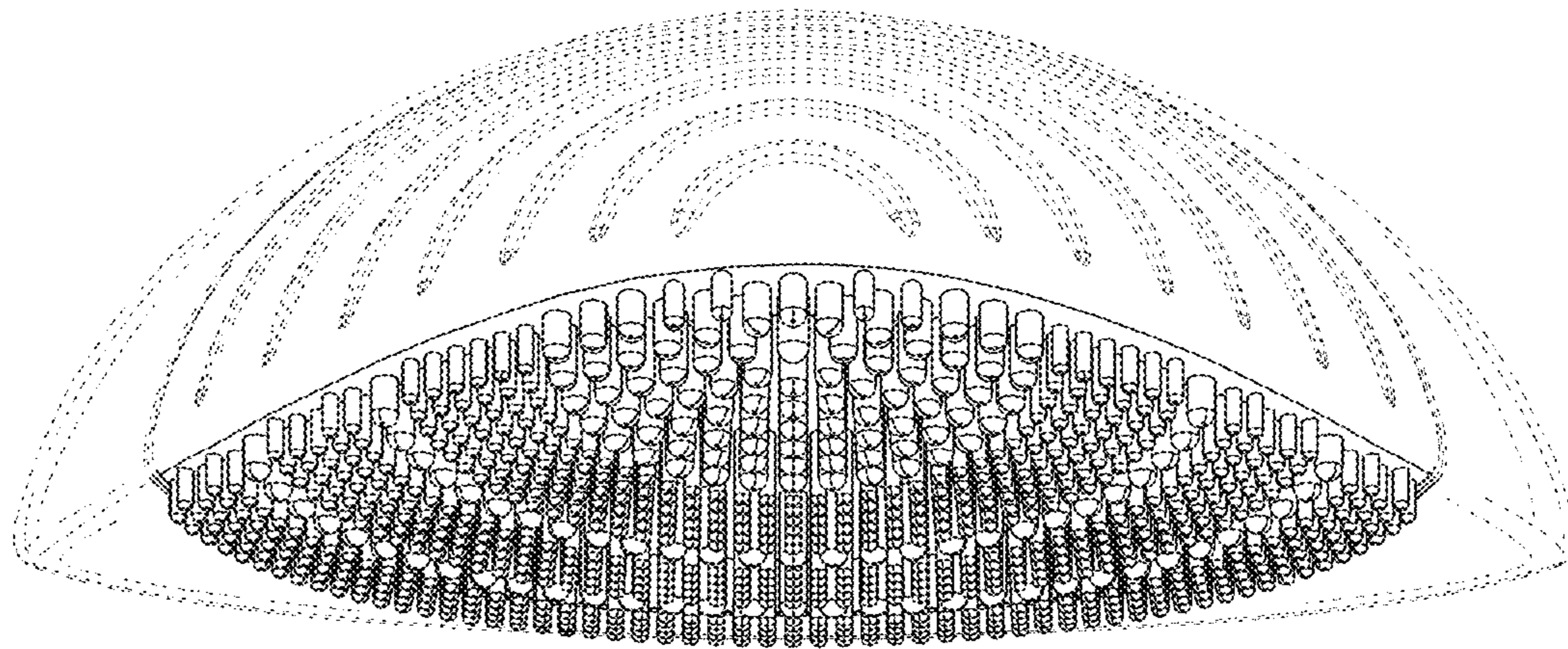

FIG. 21

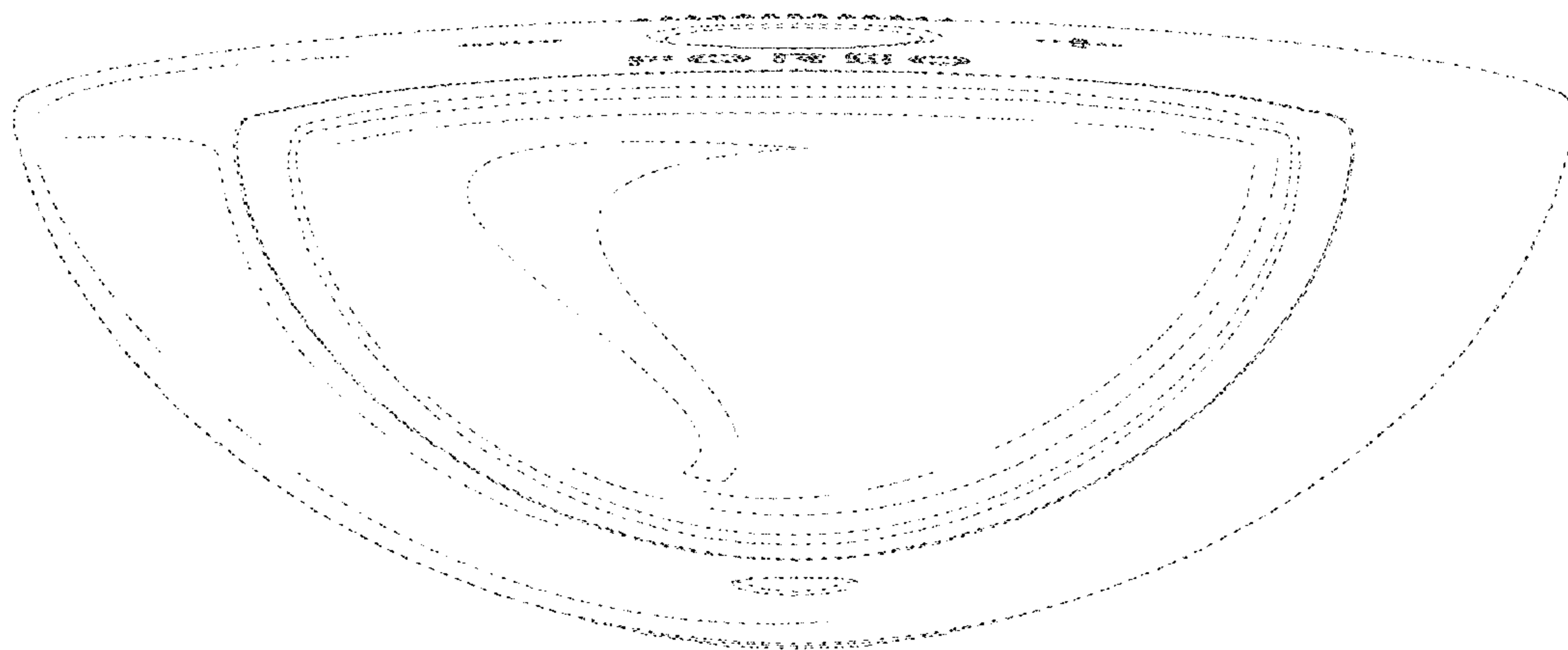

FIG. 22

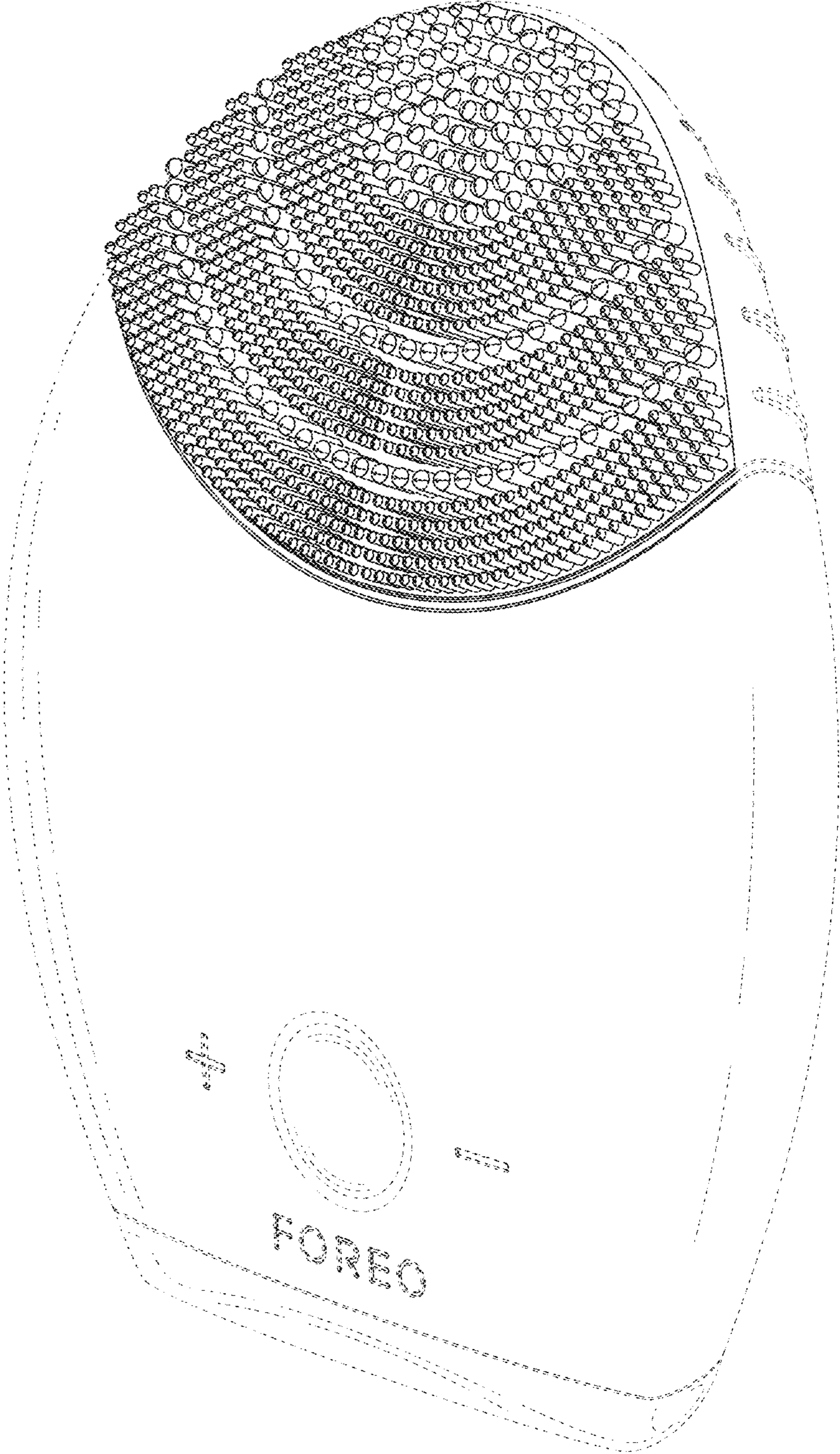

FIG. 23

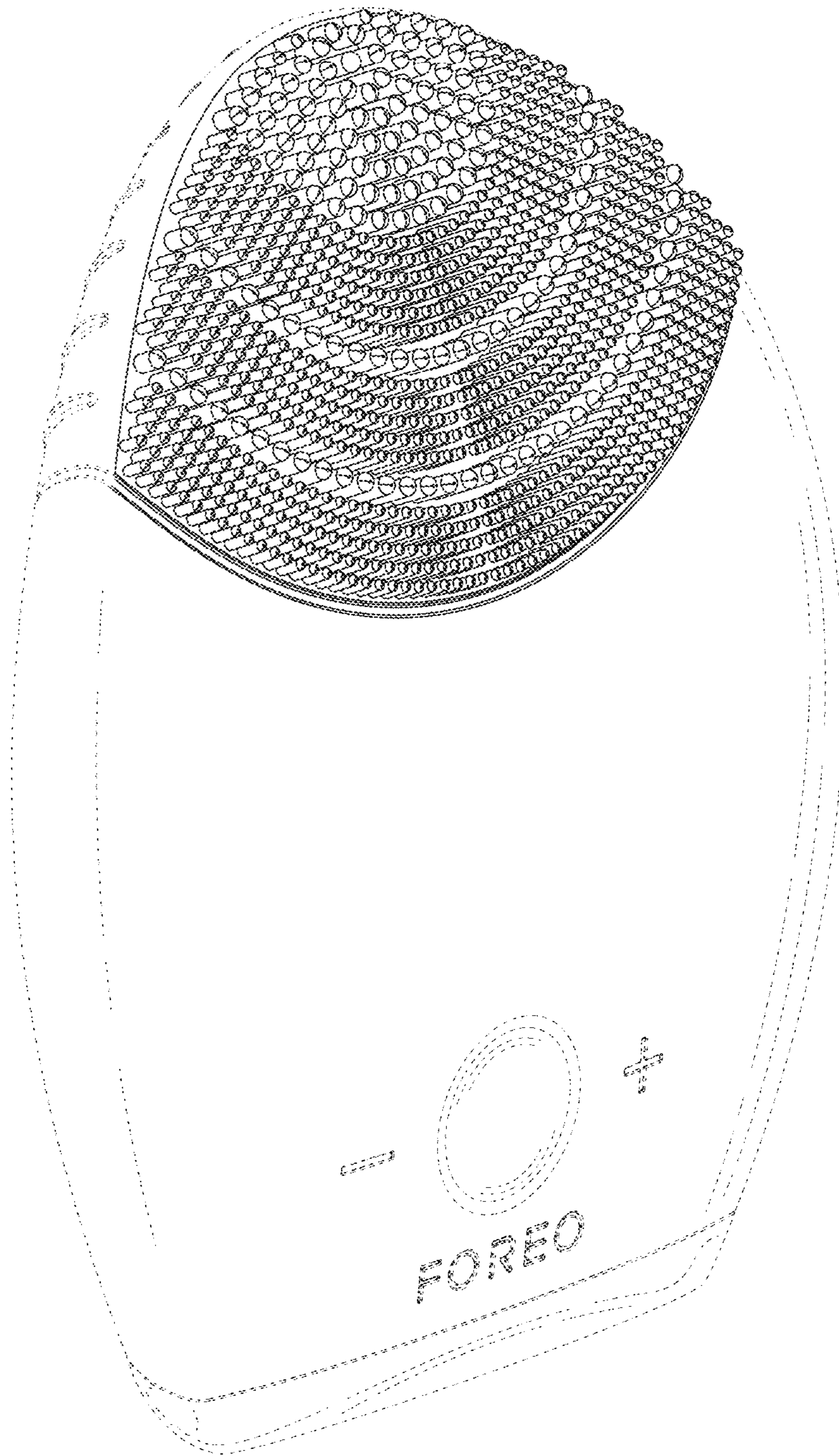

FIG. 24

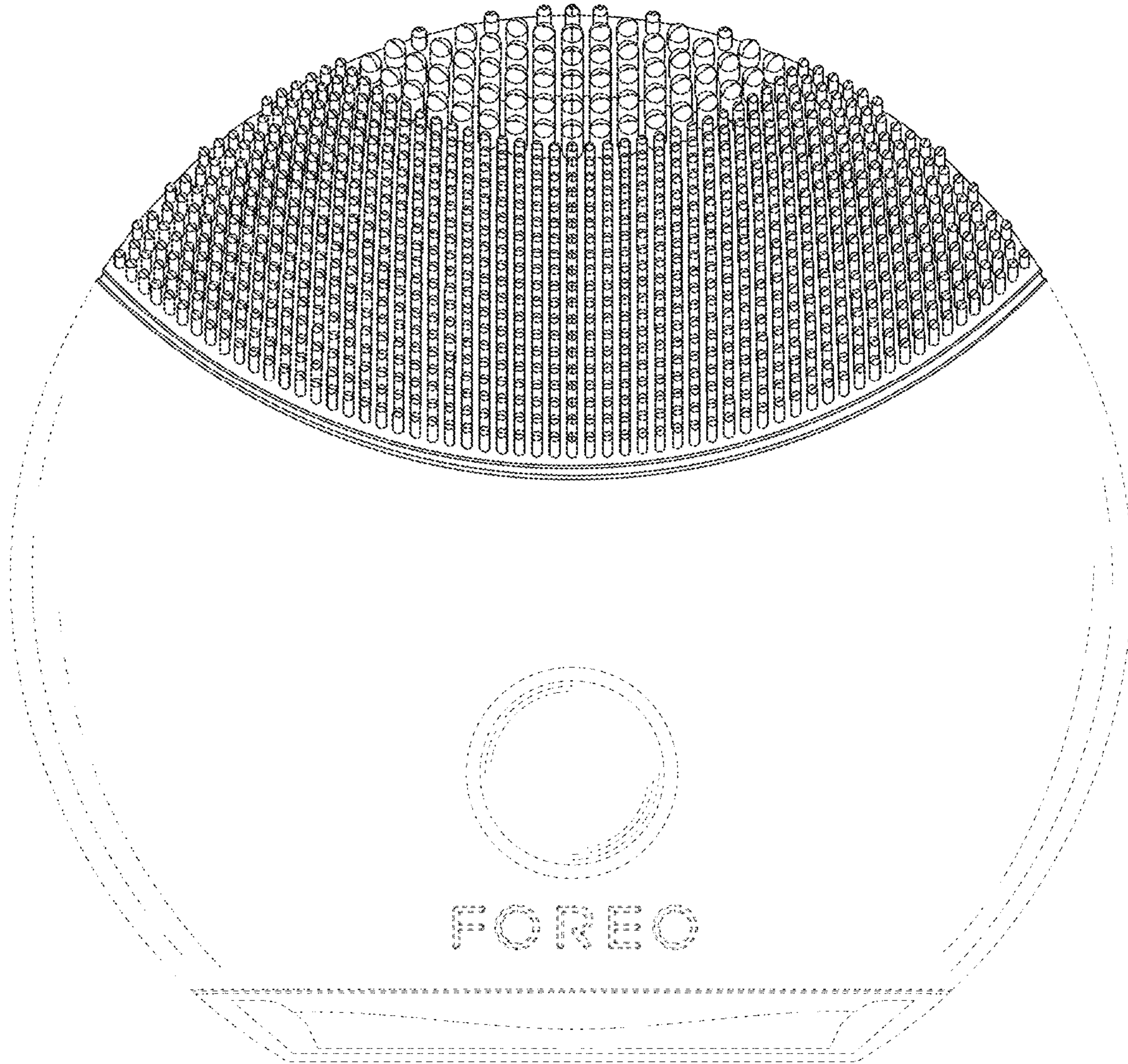

FIG. 25

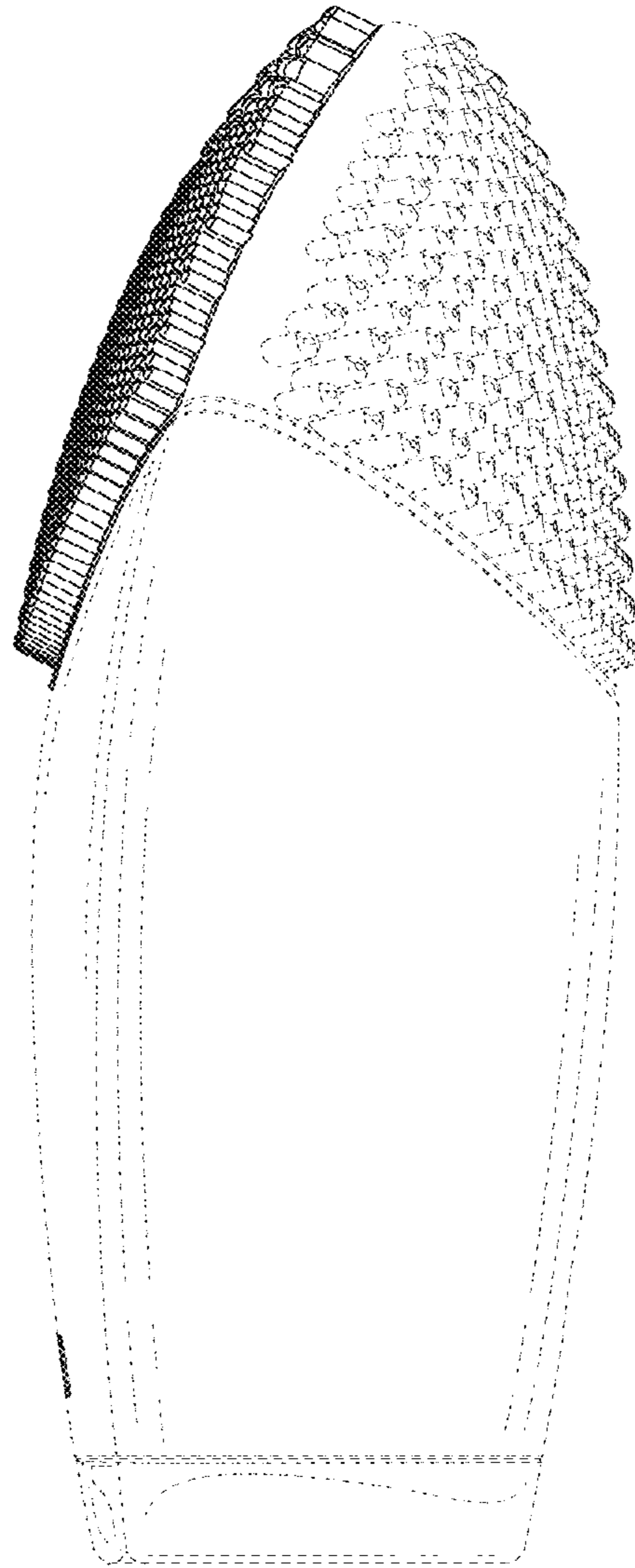

FIG. 26

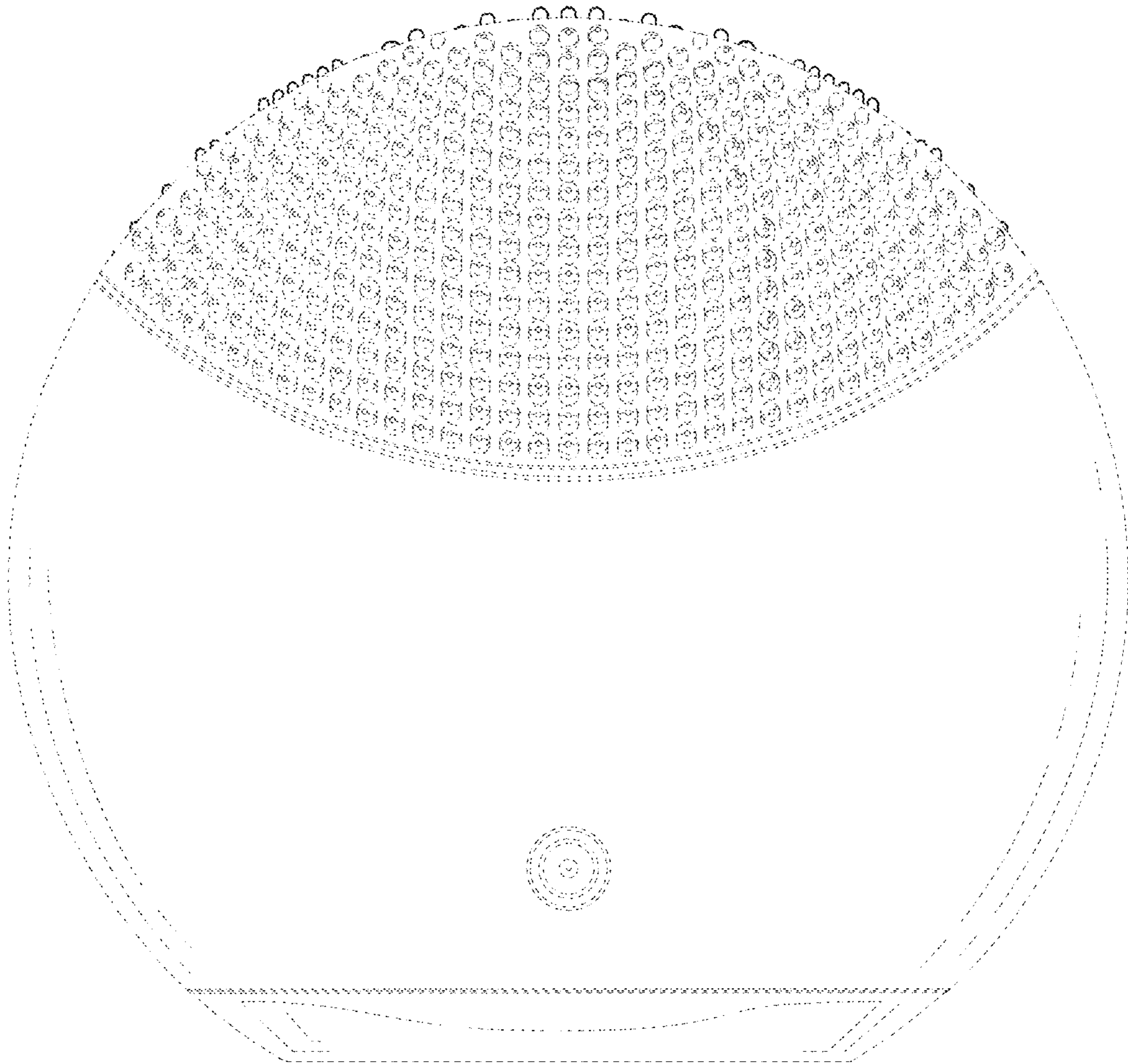

FIG. 27

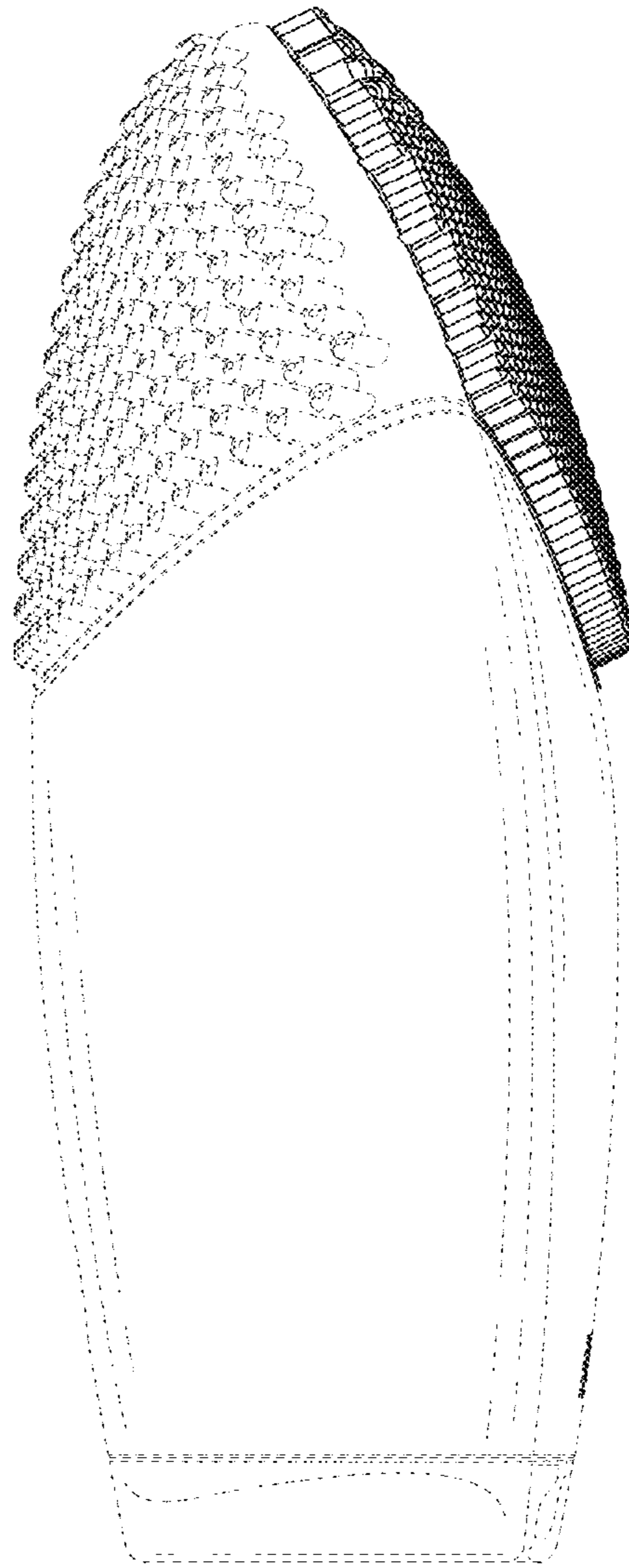

FIG. 28

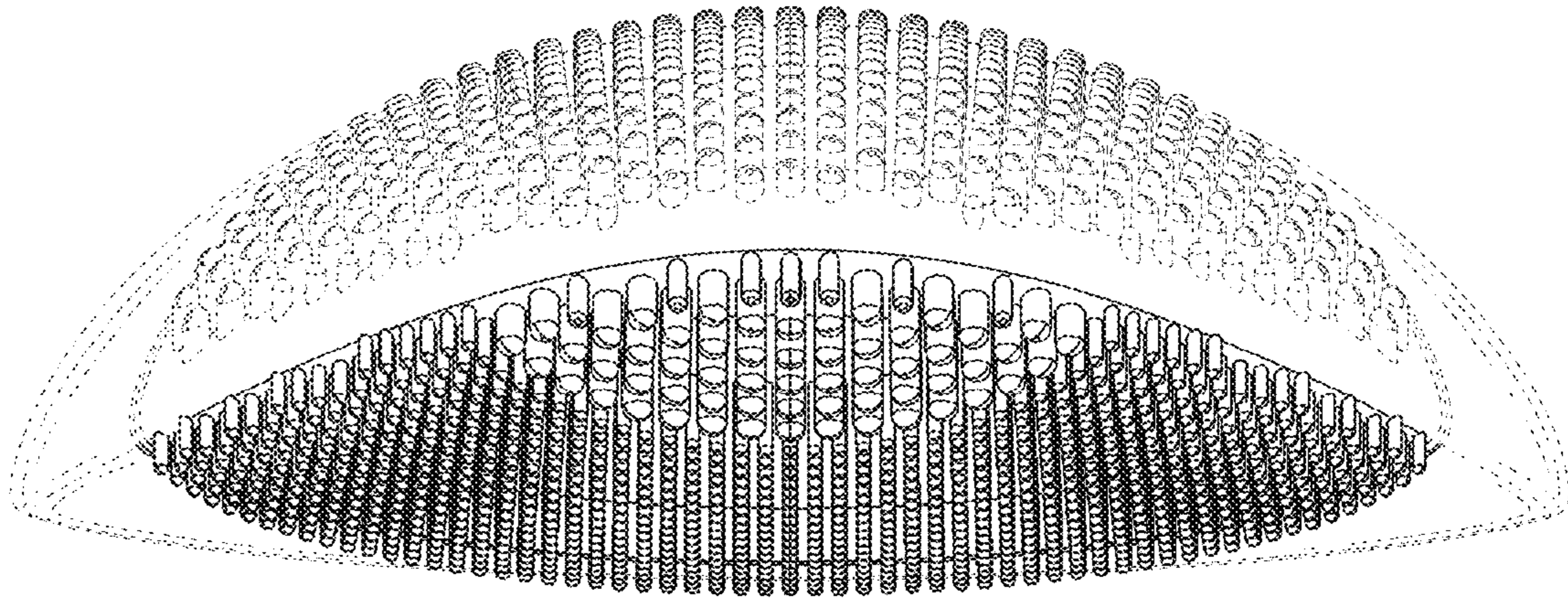

FIG. 29

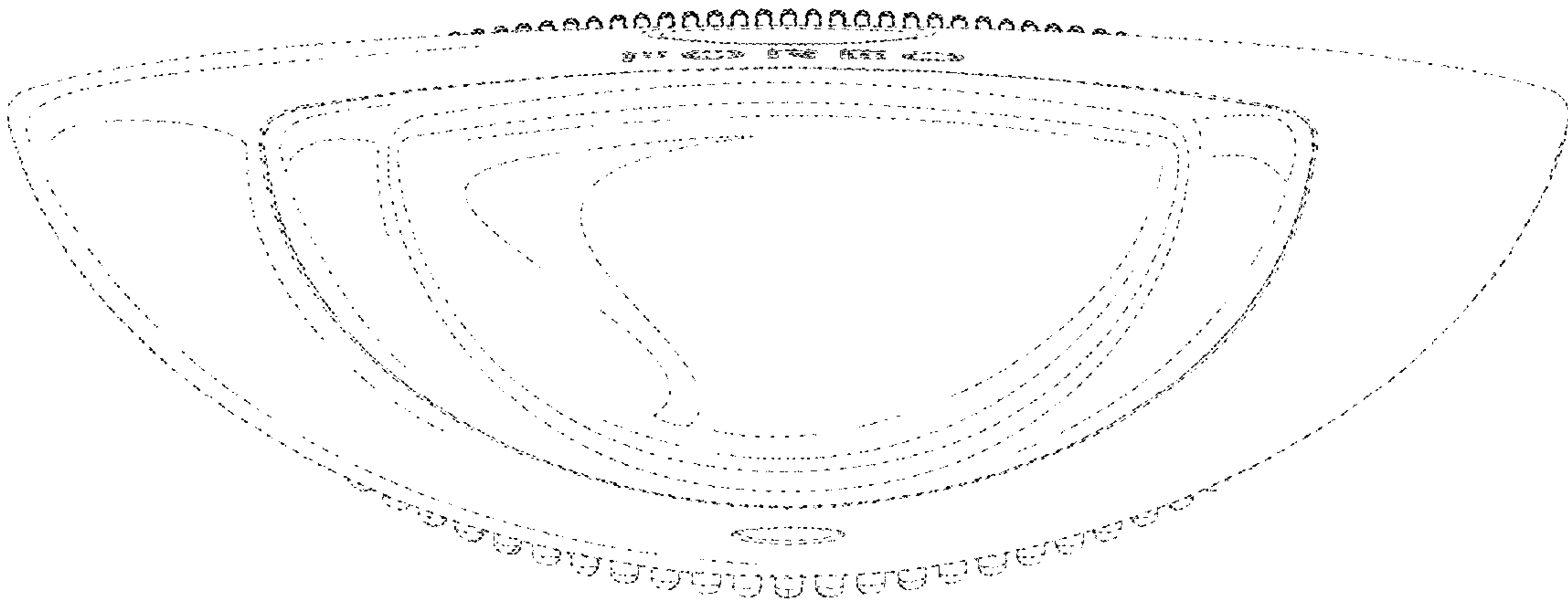

FIG. 30

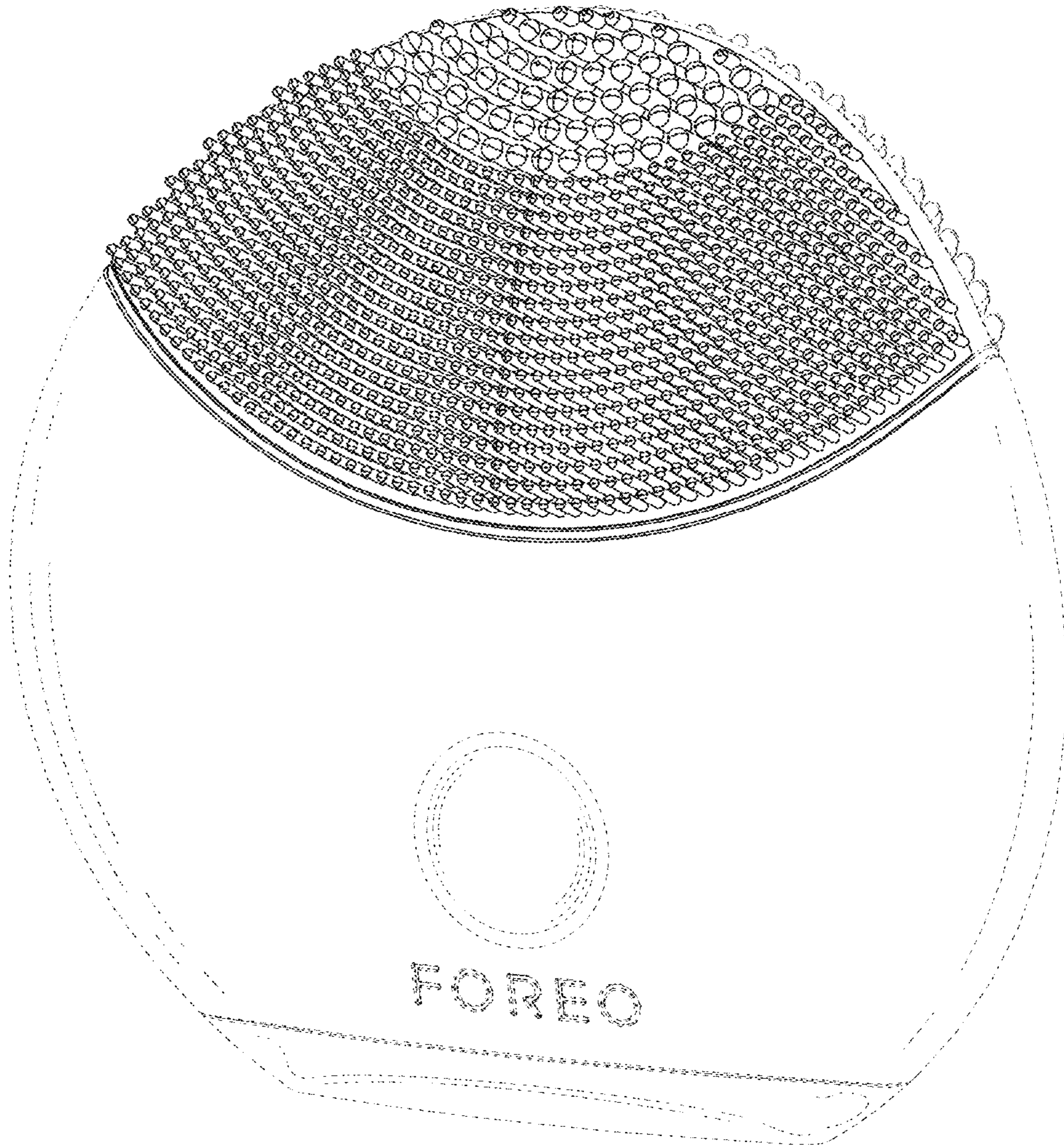

FIG. 31

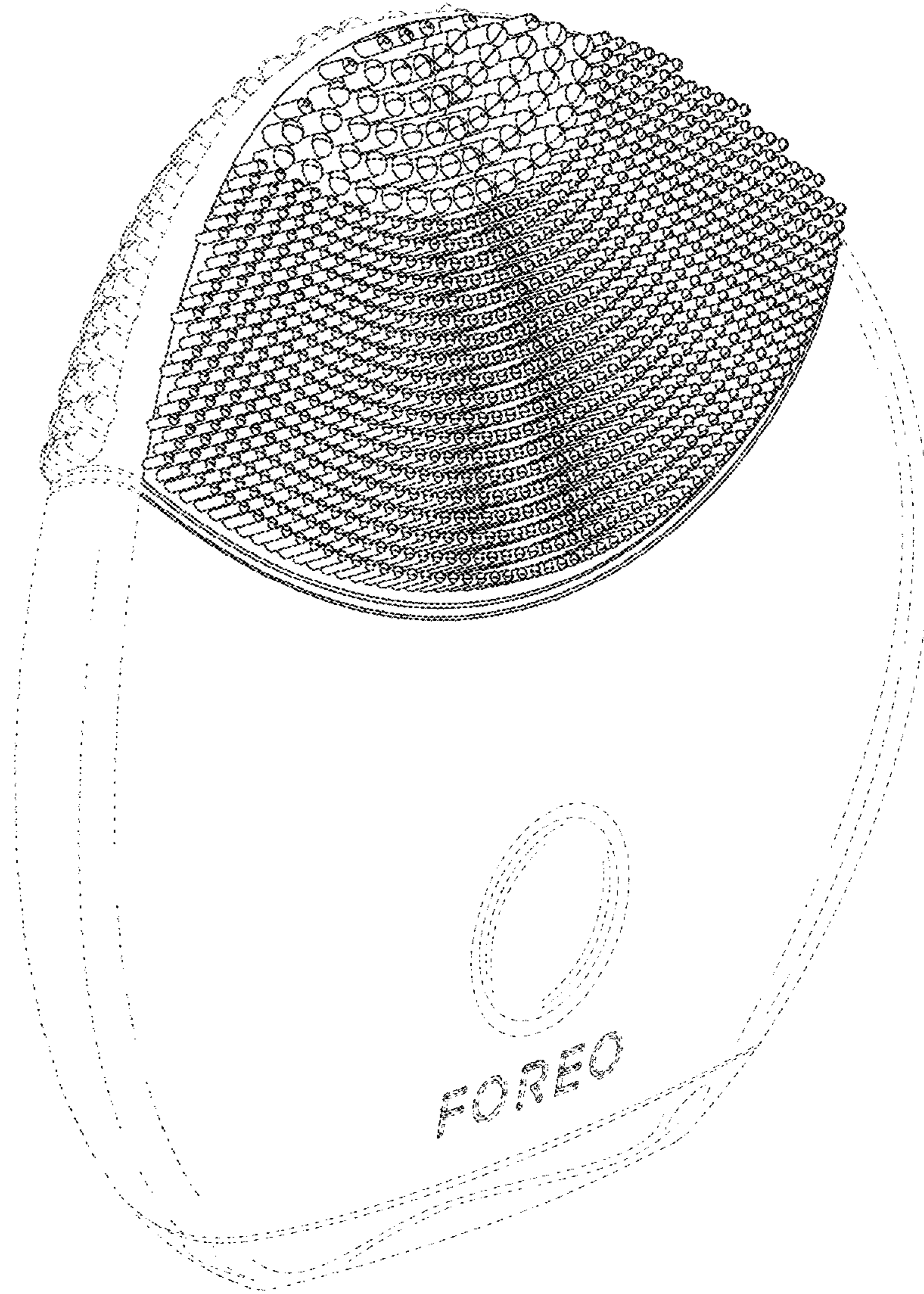

FIG. 32

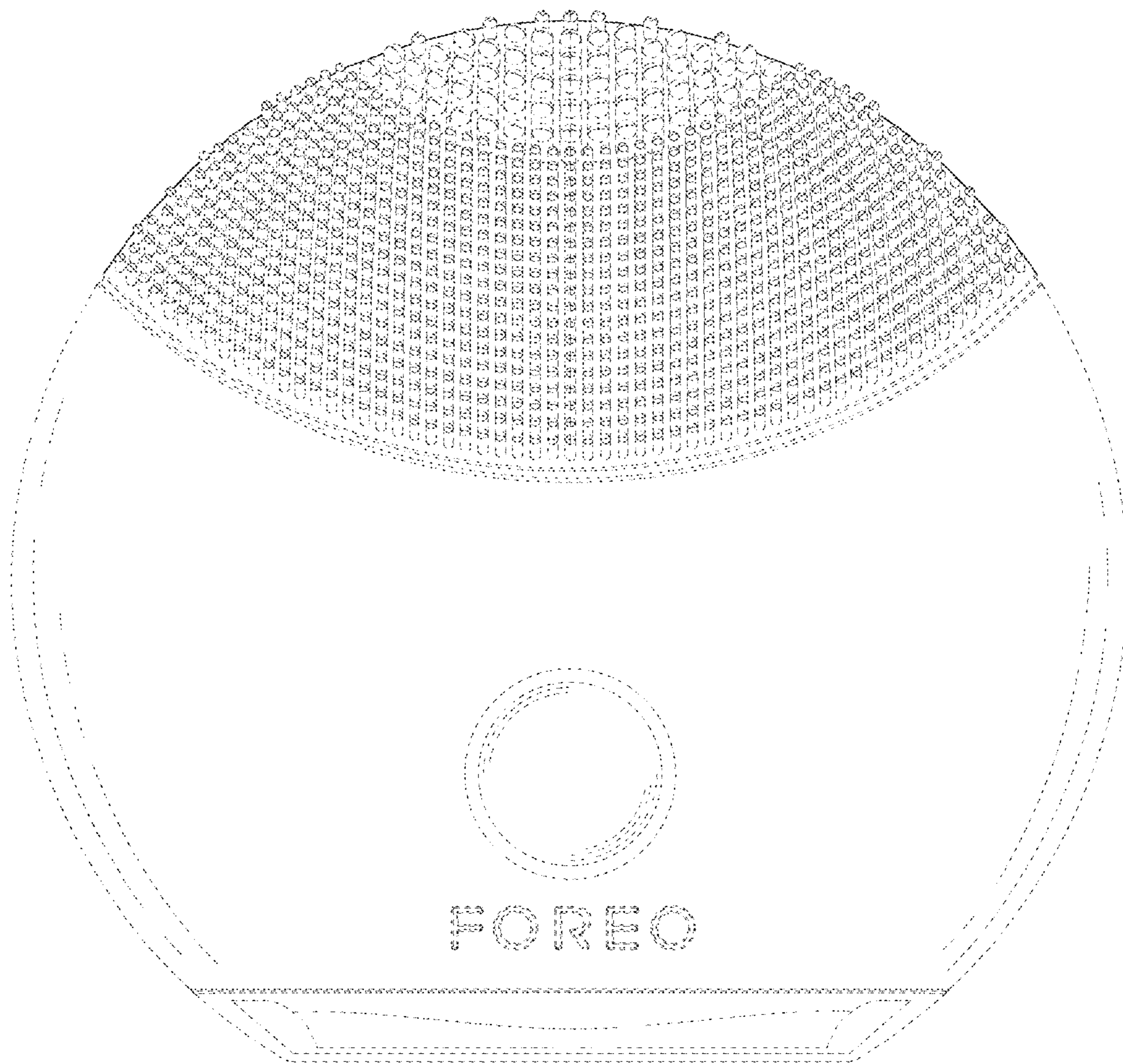

FIG. 33

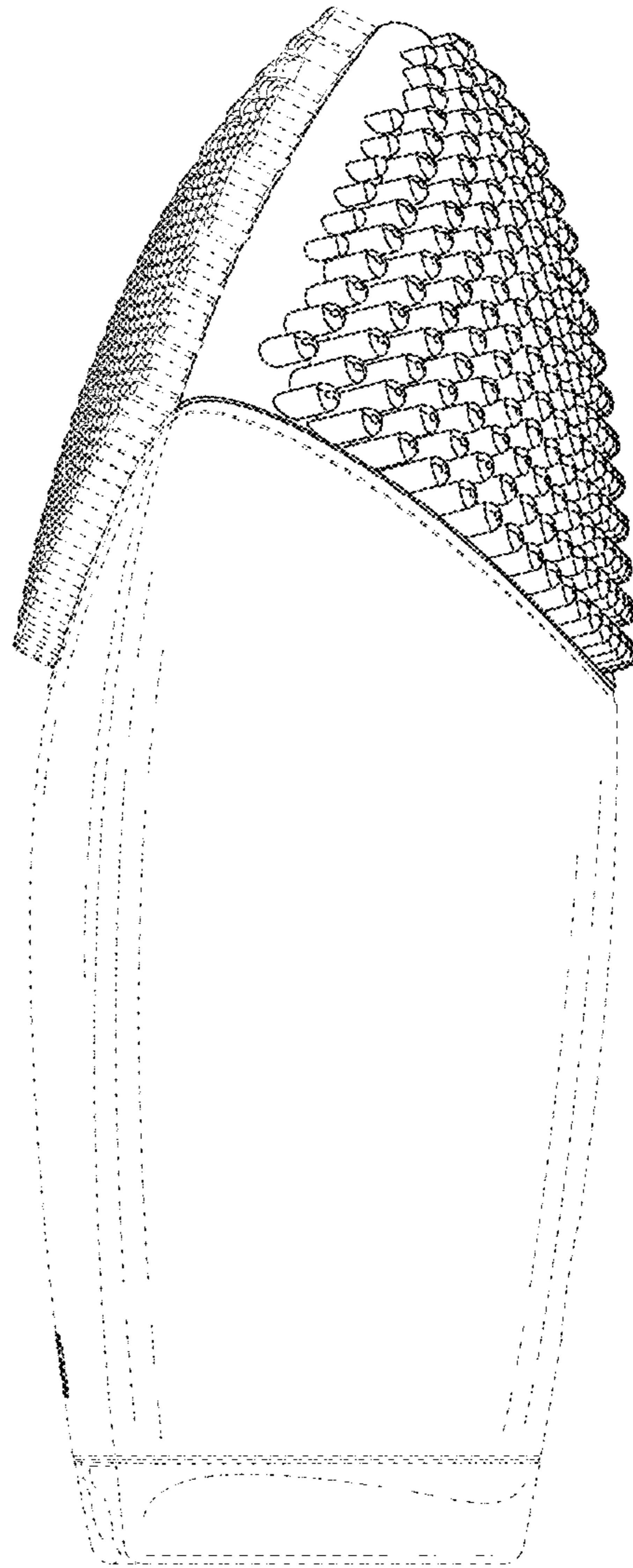

FIG. 34

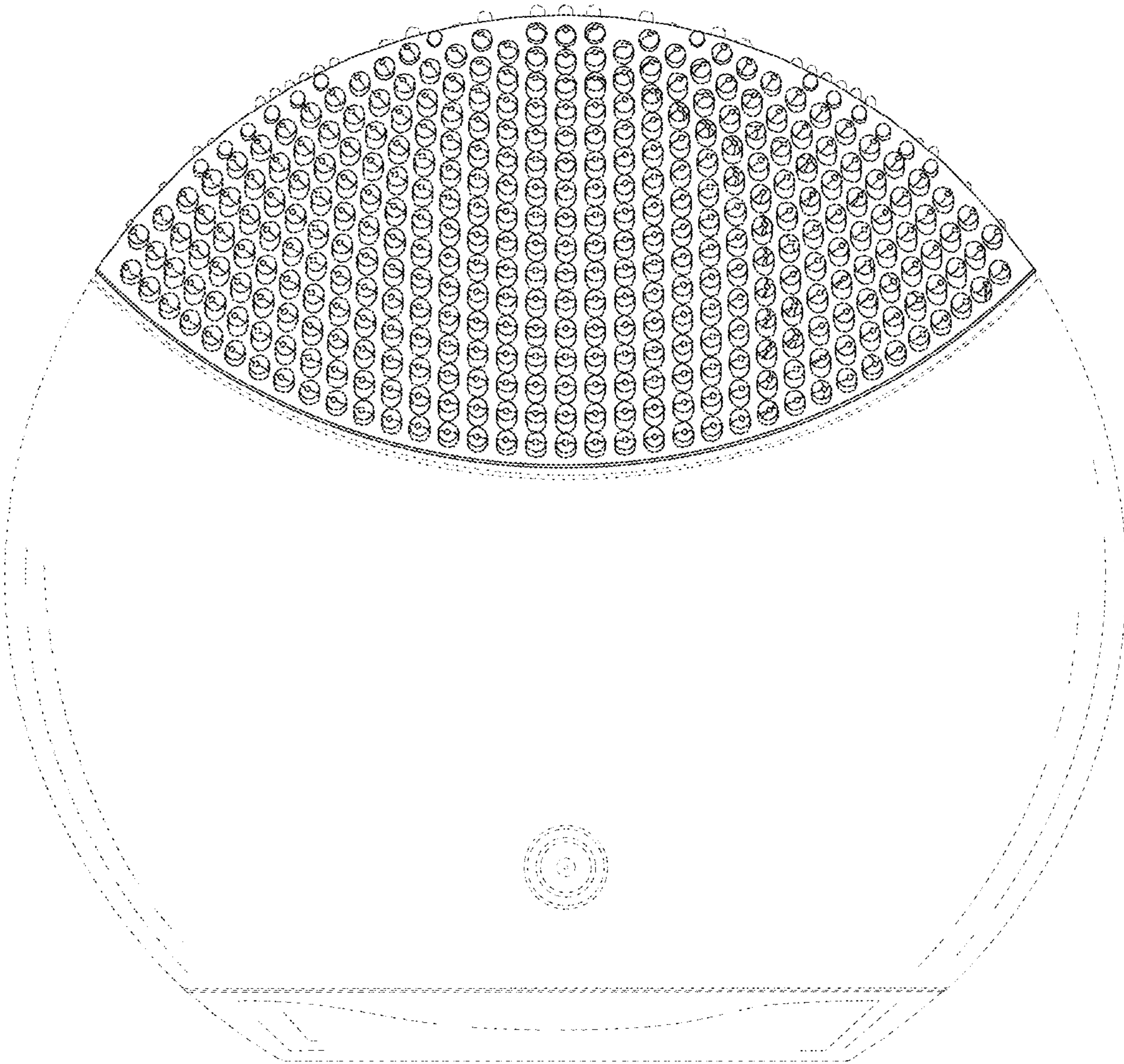

FIG. 35

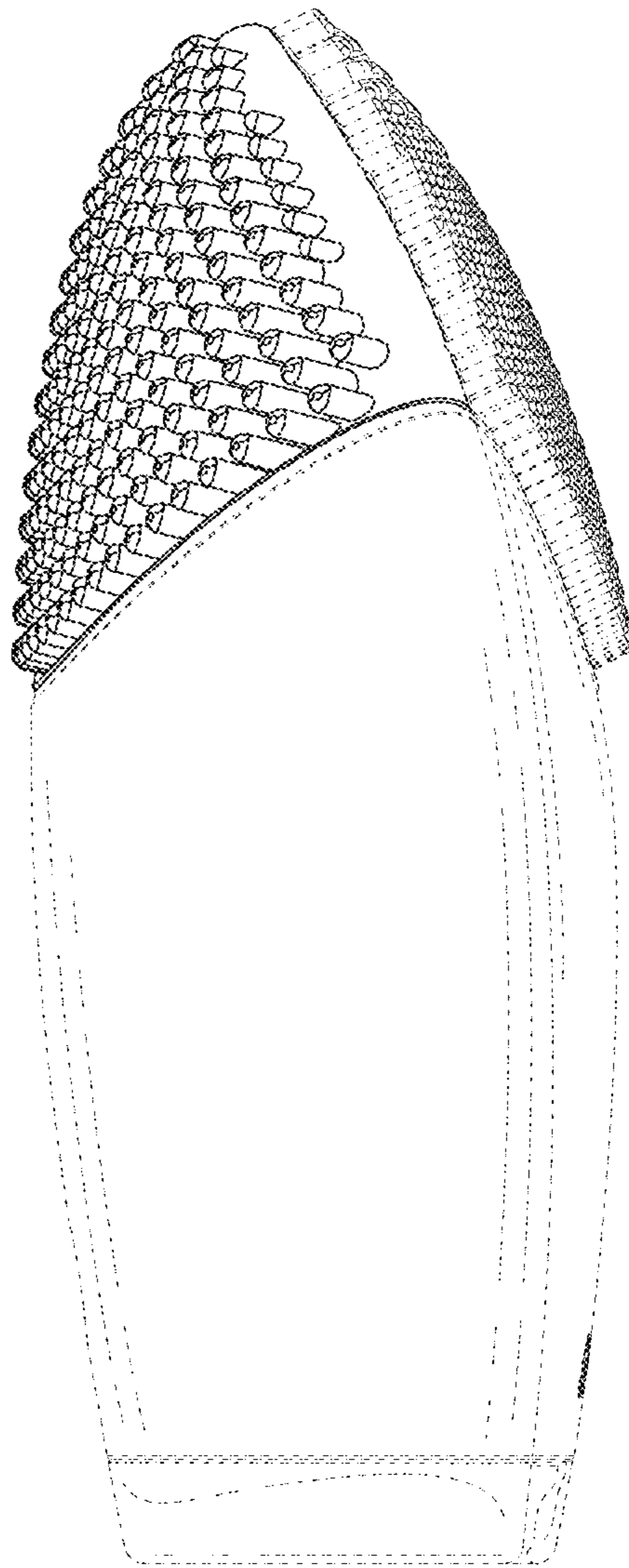

FIG. 36

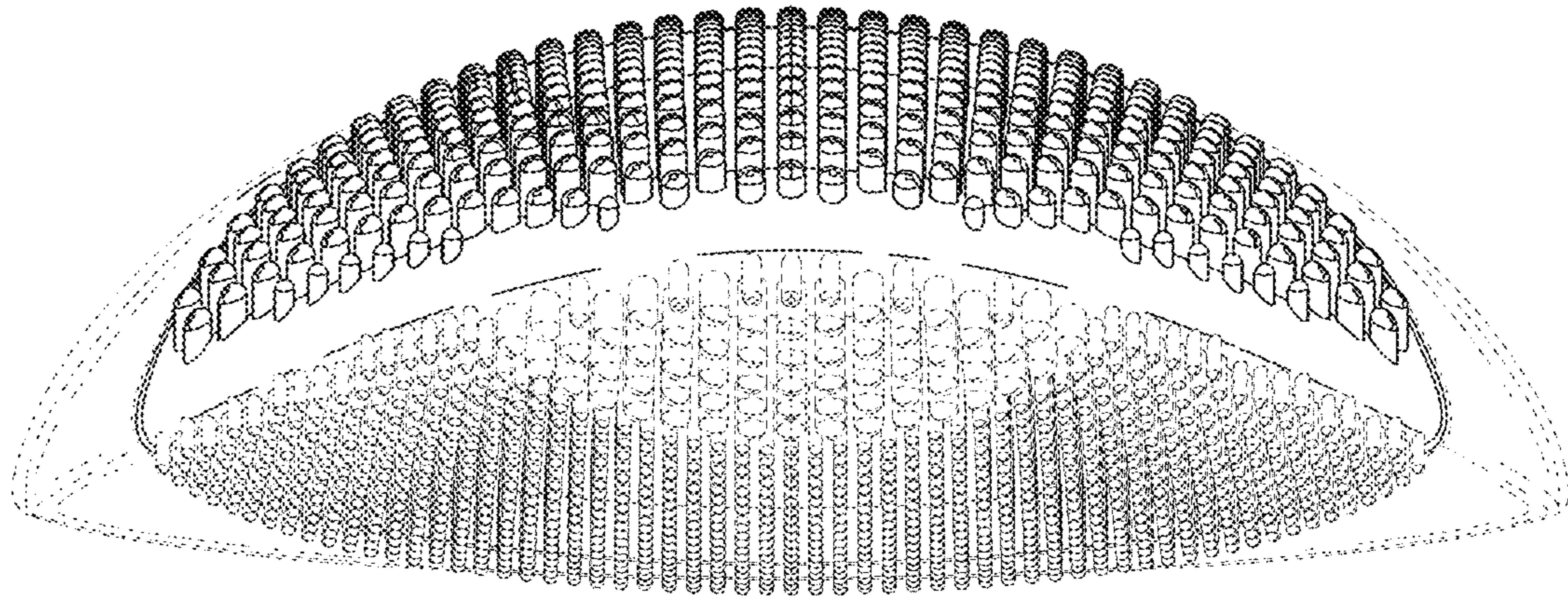

FIG. 37

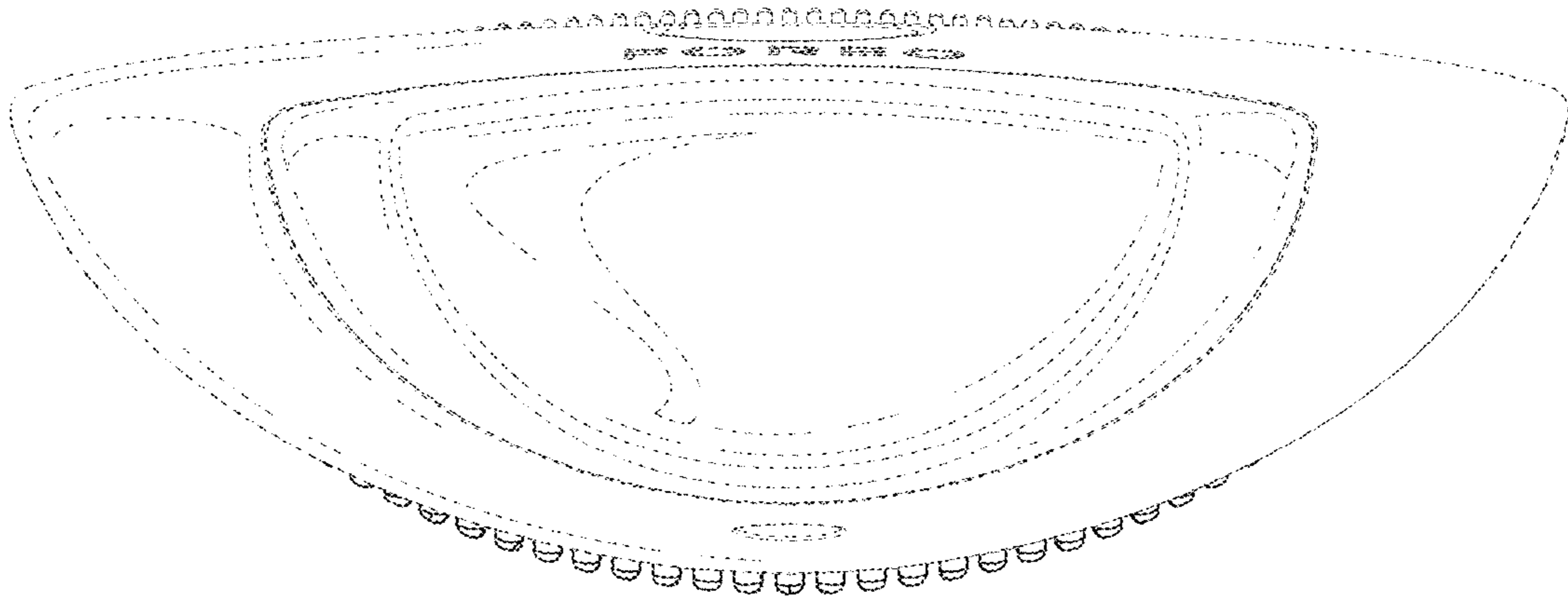

FIG. 38



FIG. 39

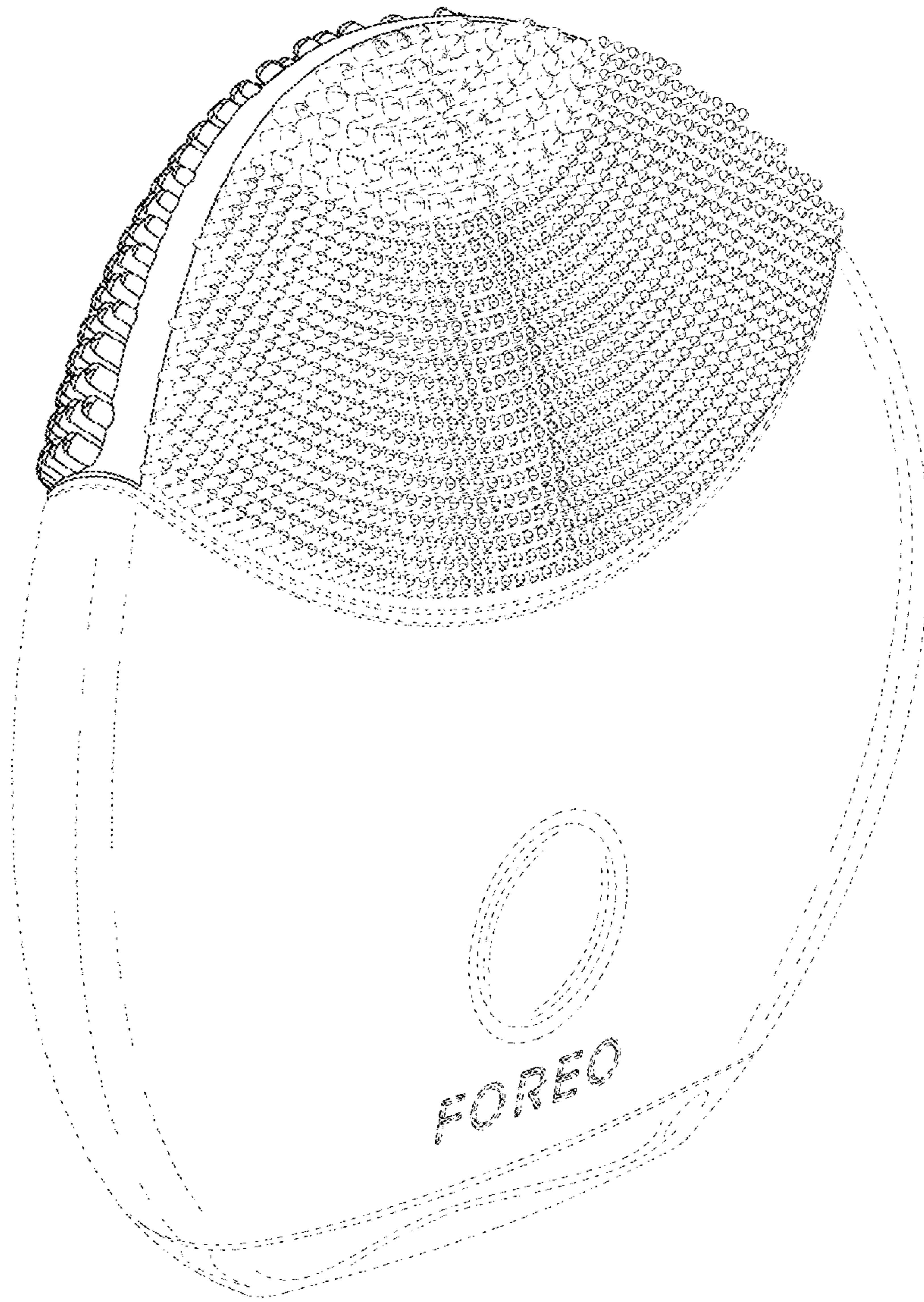

FIG. 40