



US00D783142S

(12) **United States Design Patent** (10) **Patent No.:** **US D783,142 S**
Poulton et al. (45) **Date of Patent:** **** Apr. 4, 2017**

(54) **FAN**
(71) Applicant: **Dyson Technology Limited**, Wiltshire (GB)
(72) Inventors: **Roy Edward Poulton**, Swindon (GB); **Ben Thomas Edmonds**, Swindon (GB); **George Oram**, Gloucester (GB); **Thomas Douglas Ridley**, Bristol (GB); **Leanne Joyce Garner**, Bristol (GB); **Adam James Bates**, Oxford (GB); **Peter David Gammack**, Gloucester (GB); **Andrea Ee-Va Lim**, Bristol (GB)

D747,450 S * 1/2016 Dyson D23/356
D749,231 S * 2/2016 Dyson D24/206
D768,281 S * 10/2016 Peet D23/370
D768,840 S * 10/2016 Peet D23/370
D768,841 S * 10/2016 Peet D23/370
2012/0318393 A1* 12/2012 Tsen F15D 1/02
137/803
2014/0210114 A1* 7/2014 Staniforth F04D 25/08
261/30
2016/0238026 A1* 8/2016 Barclay F04D 25/08
2016/0238037 A1* 8/2016 Peet F04D 25/08
2016/0238038 A1* 8/2016 Hughes F04D 29/703
2016/0238039 A1* 8/2016 Stewart F04D 29/403

* cited by examiner

(73) Assignee: **Dyson Technology Limited**, Malmesbury, Wiltshire (GB)

Primary Examiner — Susan Bennett Hattan
Assistant Examiner — Janice Hallmark

(**) Term: **15 Years**

(74) *Attorney, Agent, or Firm* — Morrison & Foerster LLP

(21) Appl. No.: **29/567,895**

(57) **CLAIM**

(22) Filed: **Jun. 13, 2016**

We claim the ornamental design for a fan, as shown and described.

(51) **LOC (10) Cl.** **23-04**

(52) **U.S. Cl.**
USPC **D23/370**

DESCRIPTION

(58) **Field of Classification Search**
USPC D23/370, 355, 385, 386, 342, 336, 337, D23/376, 378
CPC F04D 29/703; F04D 29/403; F04D 3/00; F04D 17/00
See application file for complete search history.

FIG. 1 is a perspective view of a fan showing our new design;
FIG. 2 is a front view thereof;
FIG. 3 is a rear view thereof;
FIG. 4 is a side view thereof;
FIG. 5 is a side view of the opposite side of FIG. 4;
FIG. 6 is a top view thereof; and,
FIG. 7 is a bottom view thereof.
The broken lines in the drawings depict parts of the fan that form no part of the claimed design.

(56) **References Cited**

U.S. PATENT DOCUMENTS

D728,769 S * 5/2015 Dyson D23/342
D746,966 S * 1/2016 Dyson D23/356

1 Claim, 6 Drawing Sheets

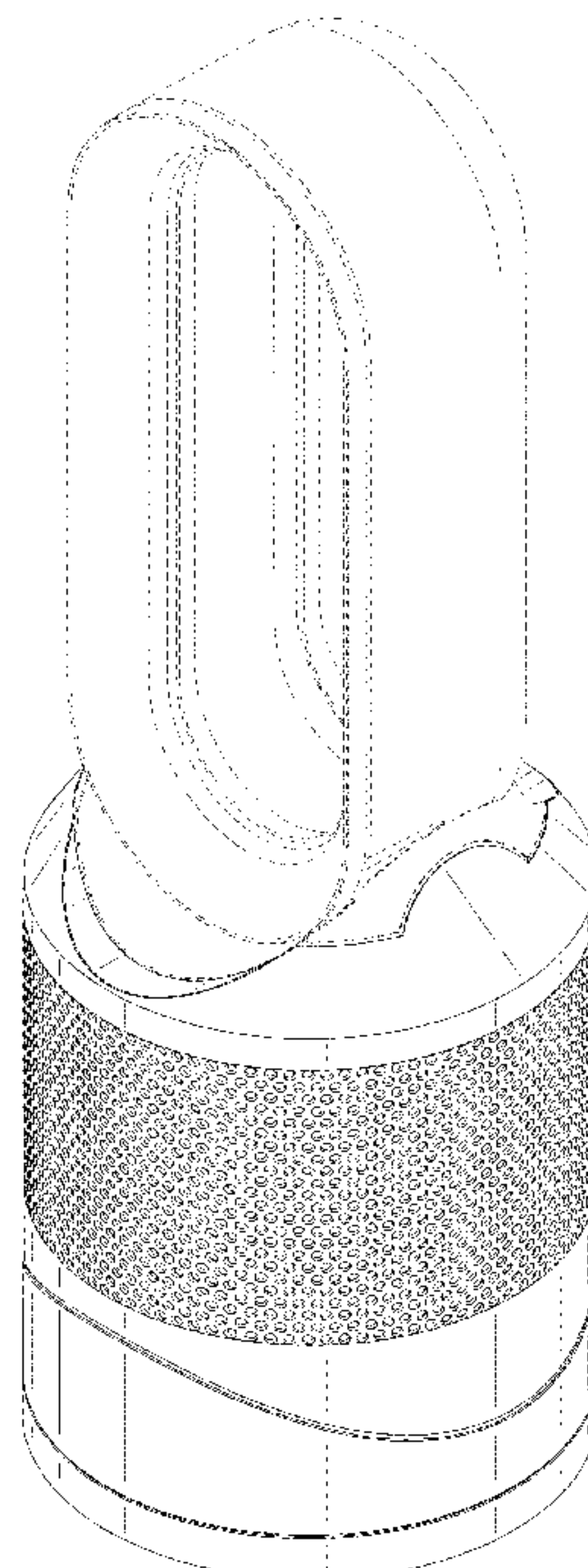

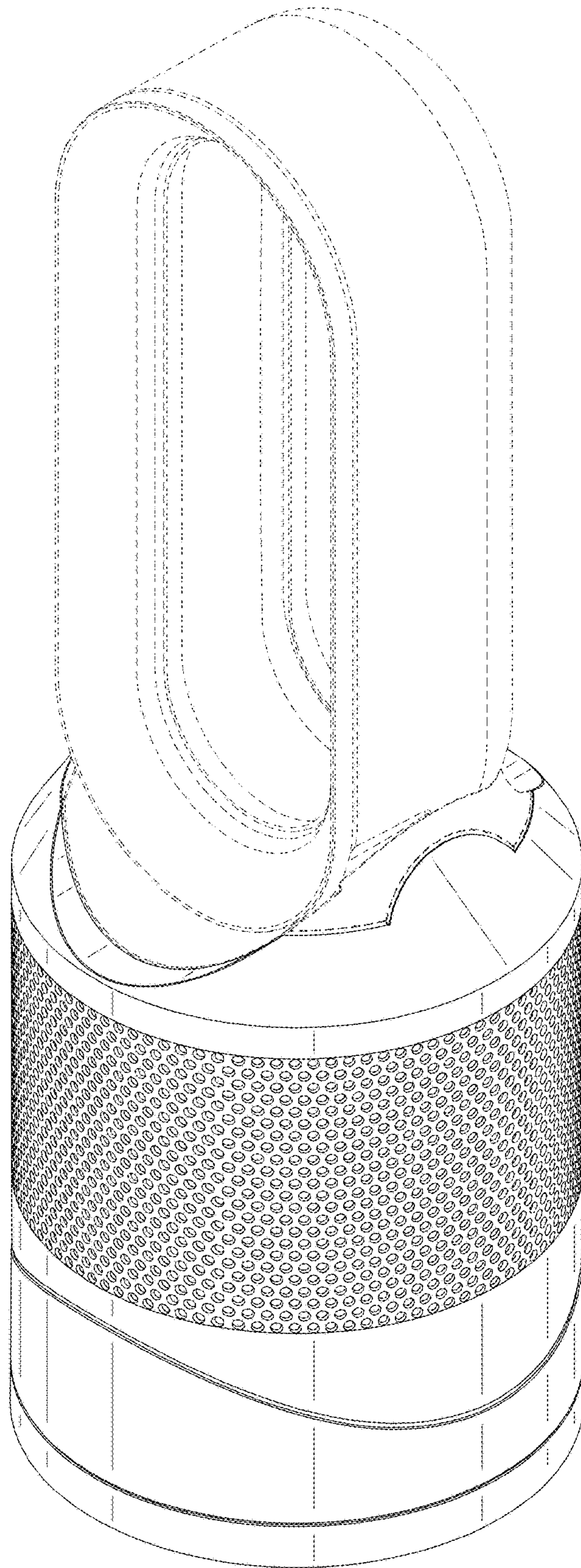

FIG. 1

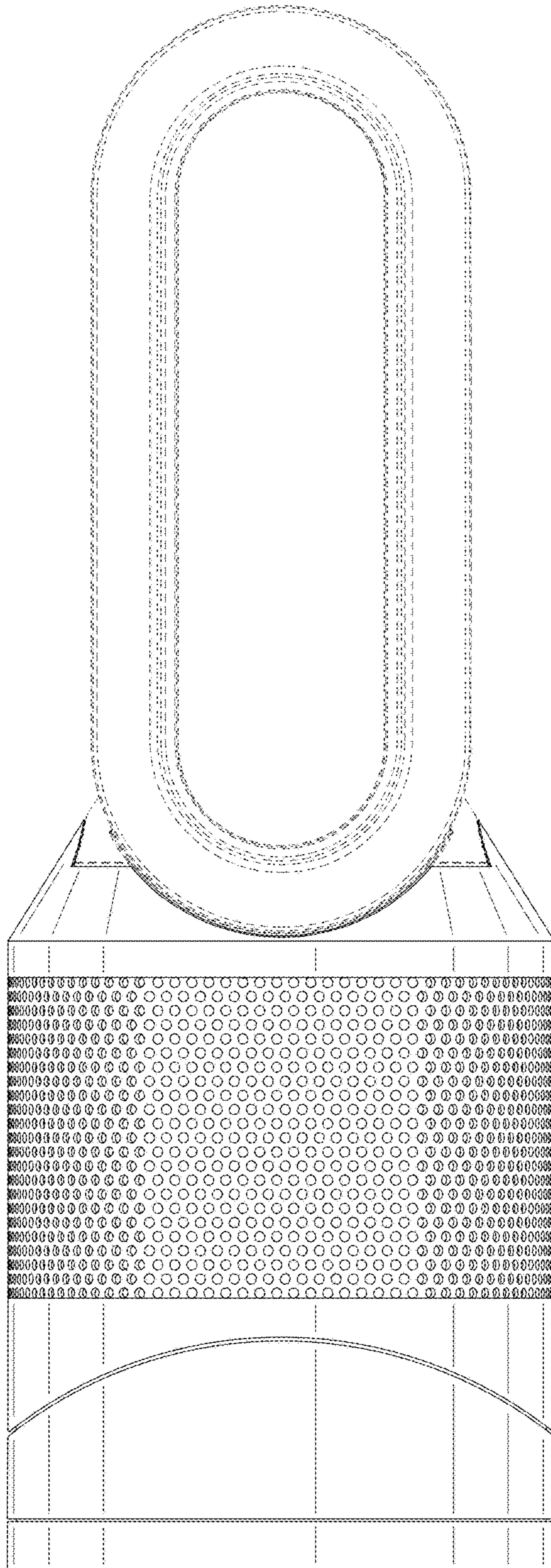

FIG. 2

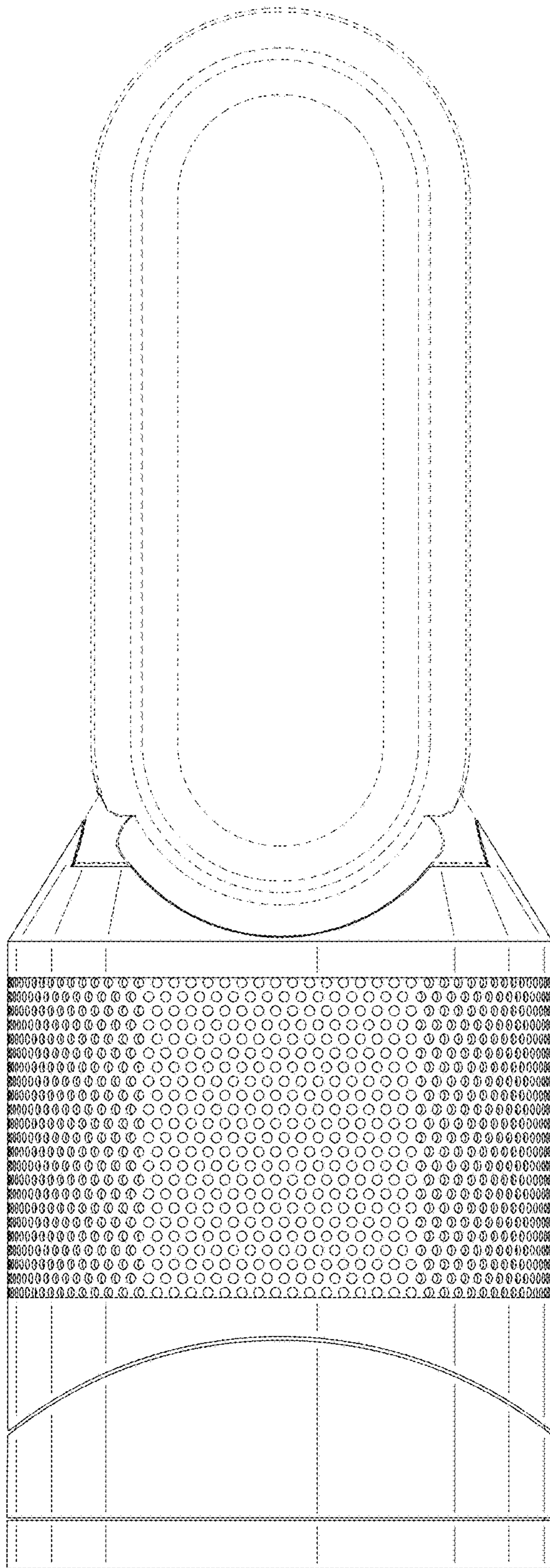

FIG. 3

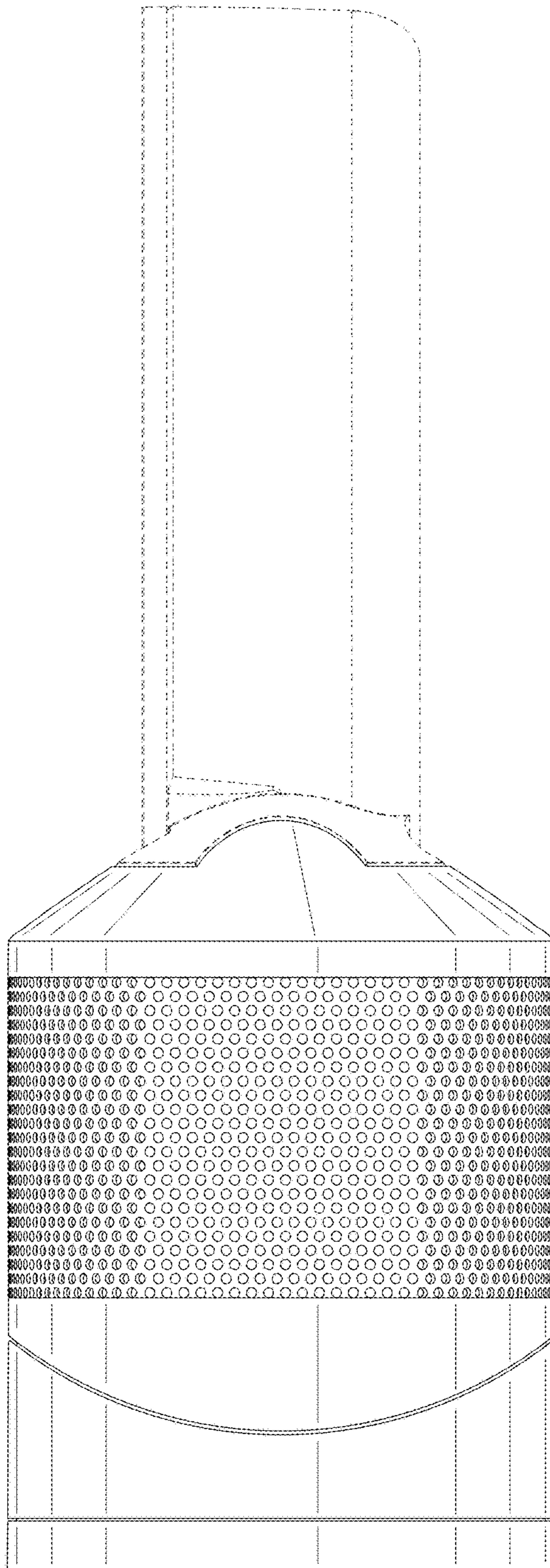

FIG. 4

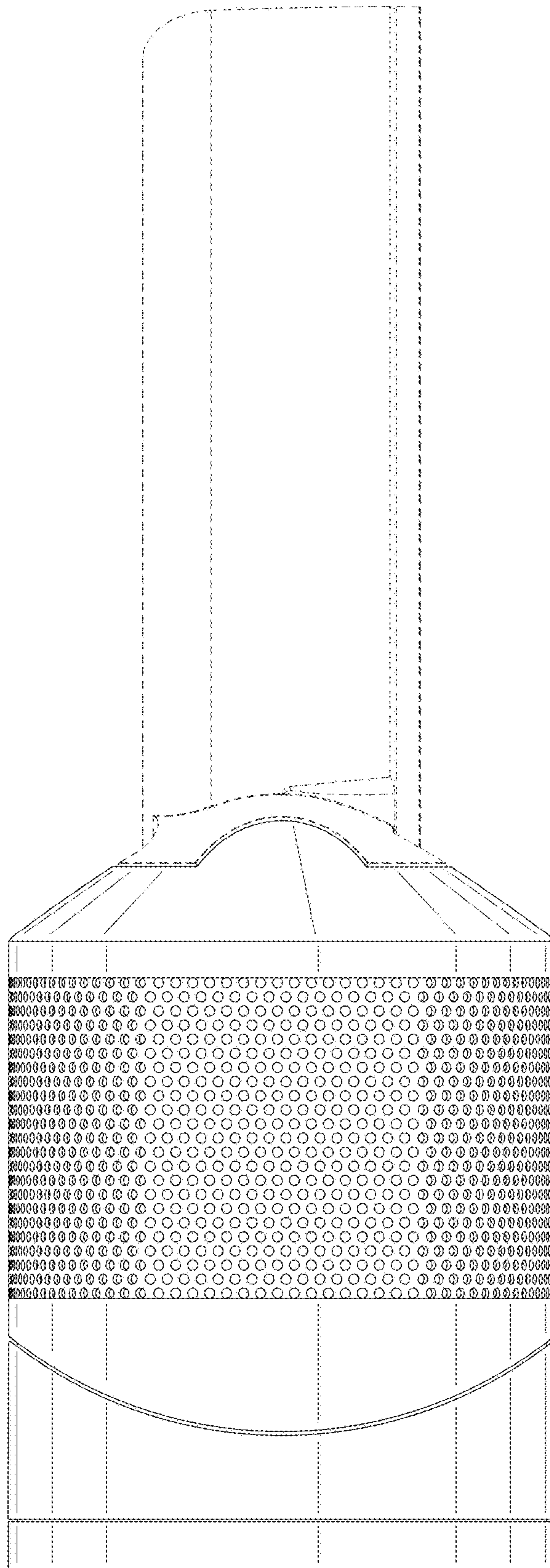

FIG. 5

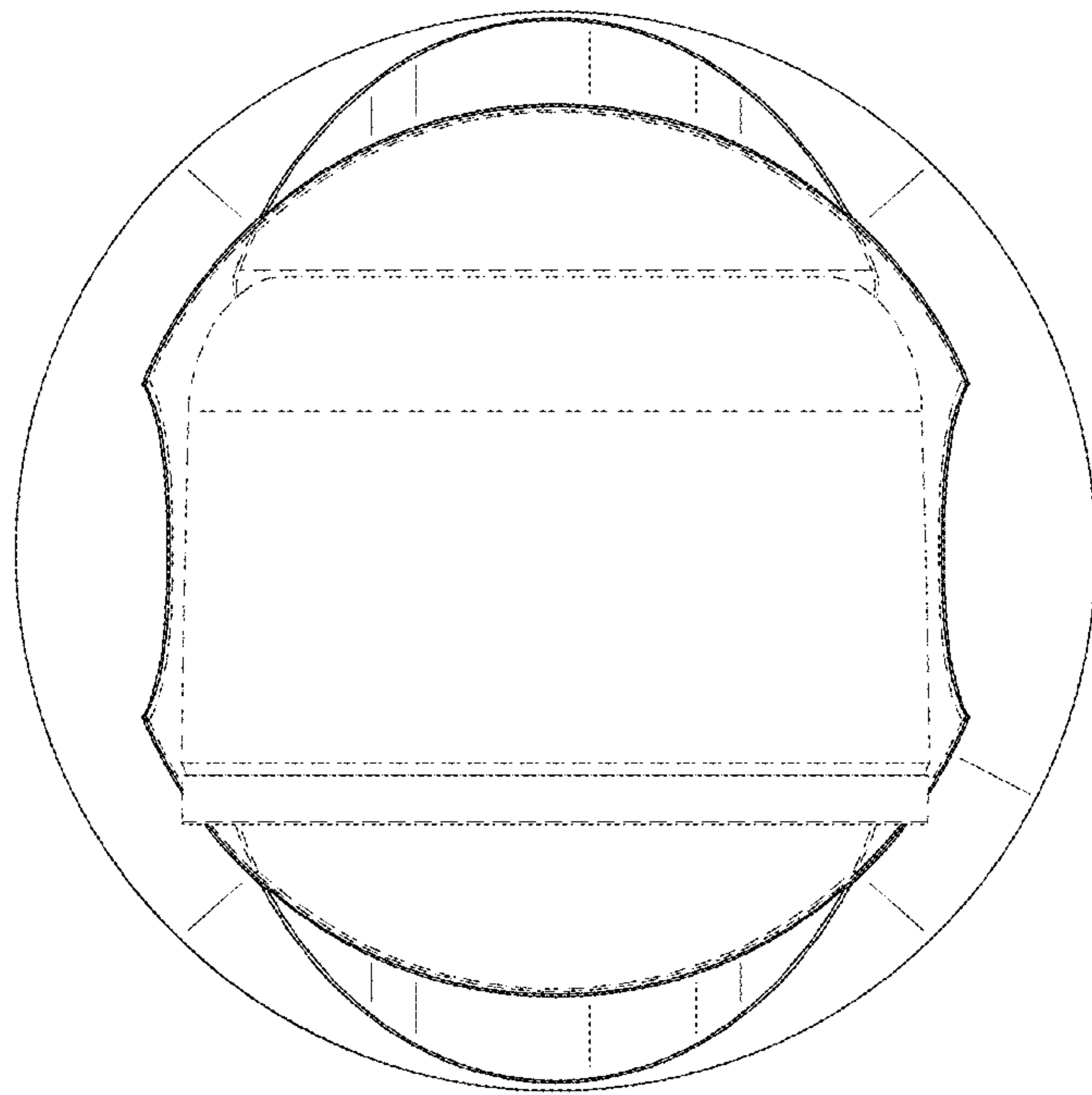

FIG. 6

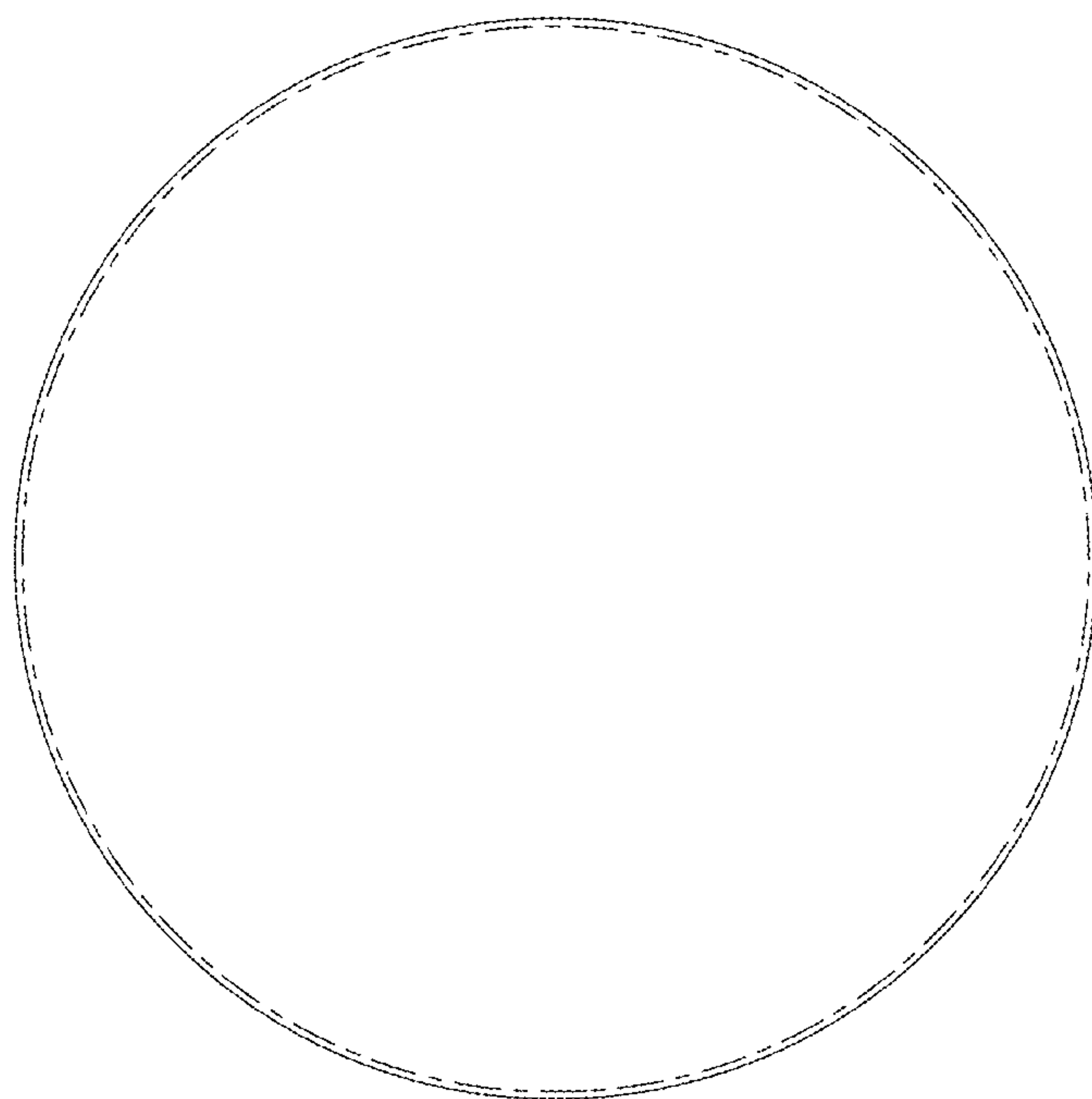

FIG. 7