



US00D783124S

(12) **United States Design Patent**
Chen

(10) **Patent No.:** **US D783,124 S**

(45) **Date of Patent:** **** Apr. 4, 2017**

(54) **WATER SPRAYER**

(71) Applicant: **Chin-Yuan Chen**, Changhua (TW)

(72) Inventor: **Chin-Yuan Chen**, Changhua (TW)

(73) Assignee: **Shin Tai Spurt Water of The Garden Tools Co. Ltd.**, Changhua (TW)

(**) Term: **15 Years**

(21) Appl. No.: **29/553,897**

(22) Filed: **Feb. 5, 2016**

(51) **LOC (10) Cl.** **23-01**

(52) **U.S. Cl.**
USPC **D23/226**

(58) **Field of Classification Search**
USPC D23/213, 223, 226; 239/526; 4/615
CPC B05B 9/01; B05B 7/02; B05B 12/002
See application file for complete search history.

(56) **References Cited**

U.S. PATENT DOCUMENTS

D453,548 S * 2/2002 Wang D23/226
D468,804 S * 1/2003 Nien D23/226

D469,850 S * 2/2003 Nien D23/226
D475,122 S * 5/2003 Kuo D23/226
D652,112 S * 1/2012 Chen D23/226
D663,382 S * 7/2012 Chen D23/226
D774,165 S * 12/2016 Chen D23/226

* cited by examiner

Primary Examiner — Robin V Webster

(74) *Attorney, Agent, or Firm* — Che-Yang Chen; Law Offices of Scott Warmuth

(57) **CLAIM**

The ornamental design for a water sprayer, as shown and described.

DESCRIPTION

FIG. 1 is a perspective view of a water sprayer showing my new design;
FIG. 2 is a front elevational view thereof;
FIG. 3 is a rear elevational view thereof;
FIG. 4 is a left side elevational view thereof;
FIG. 5 is a right side elevational view thereof;
FIG. 6 is a top plan view thereof; and,
FIG. 7 is a bottom plan view thereof.

1 Claim, 4 Drawing Sheets

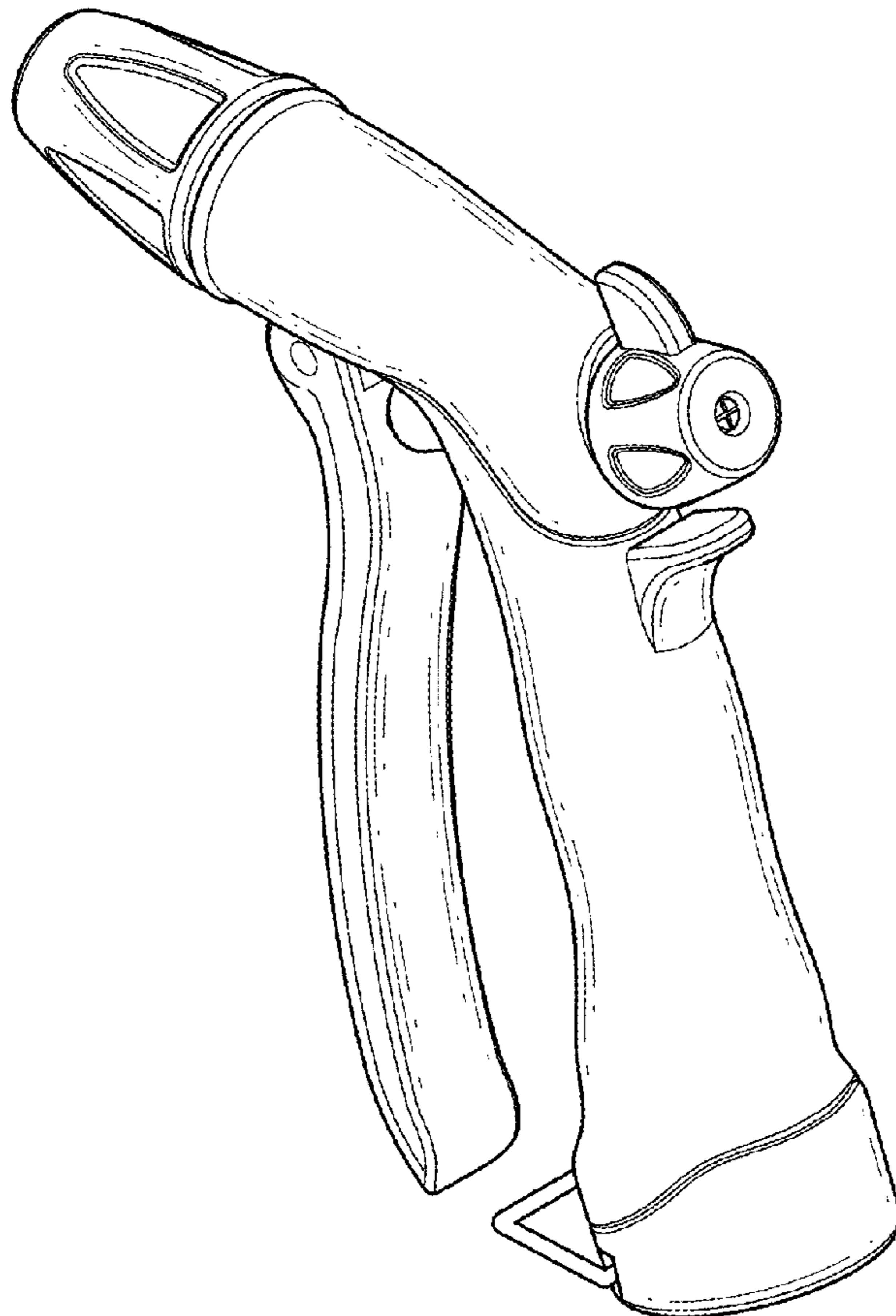

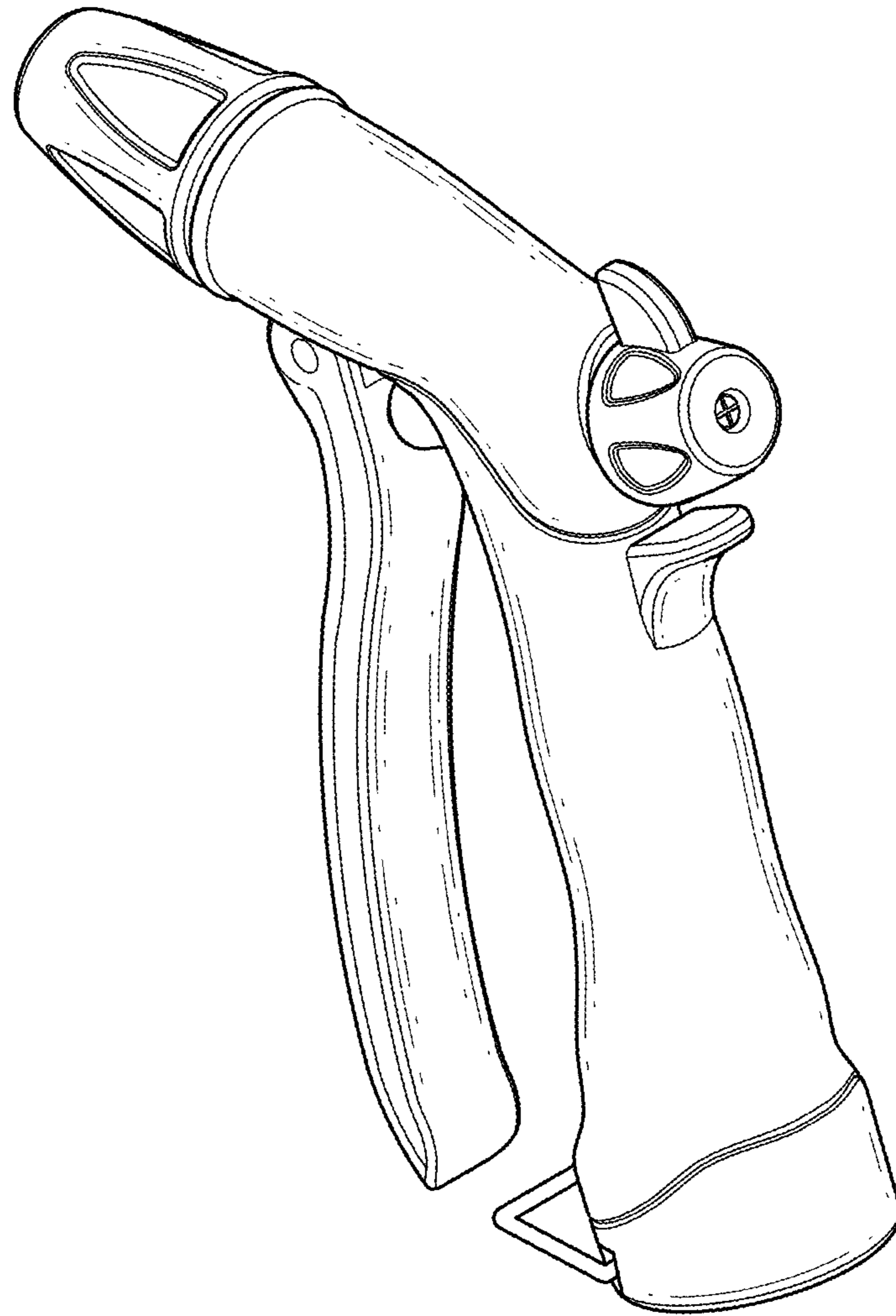

FIG. 1

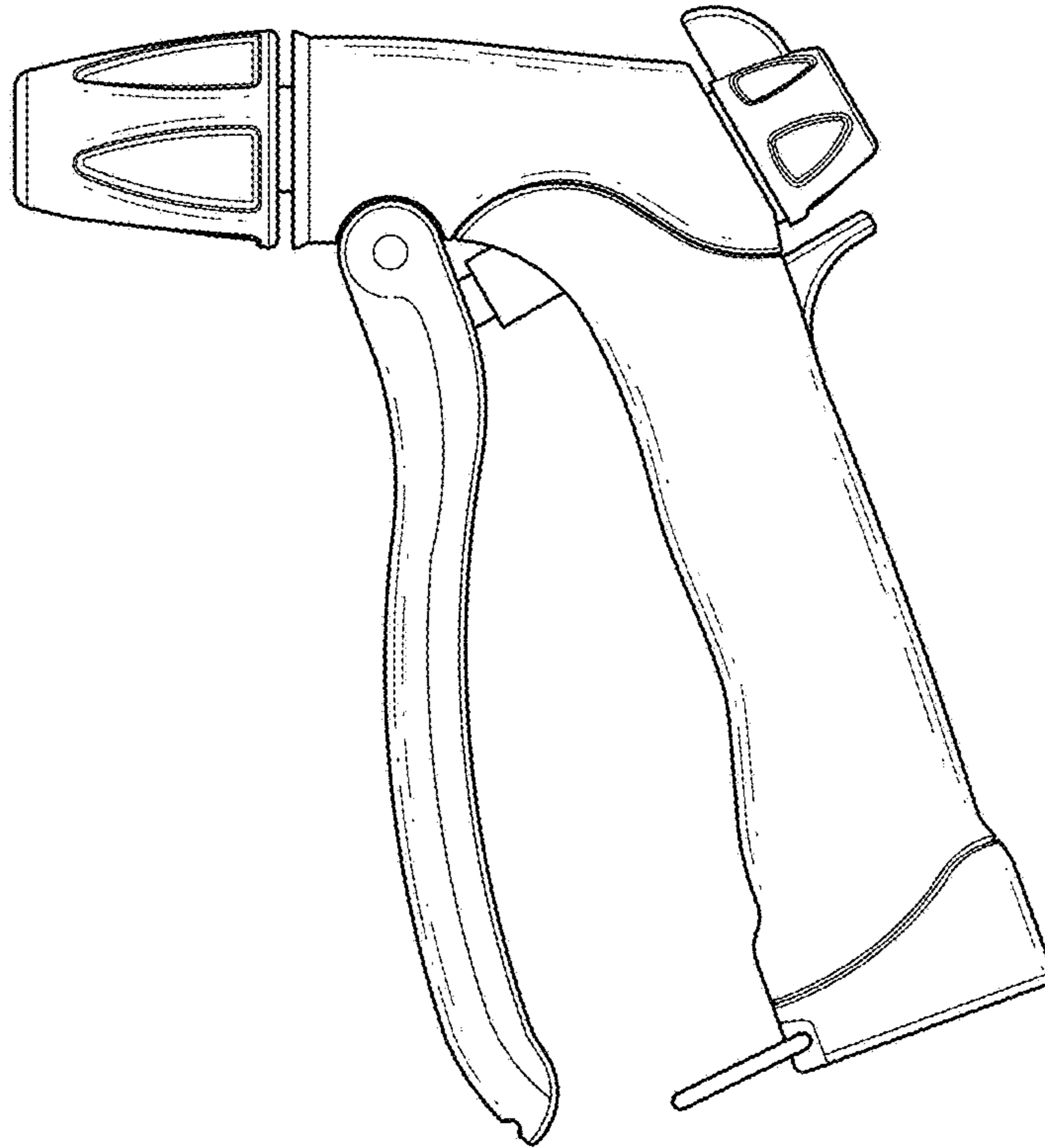

FIG. 2

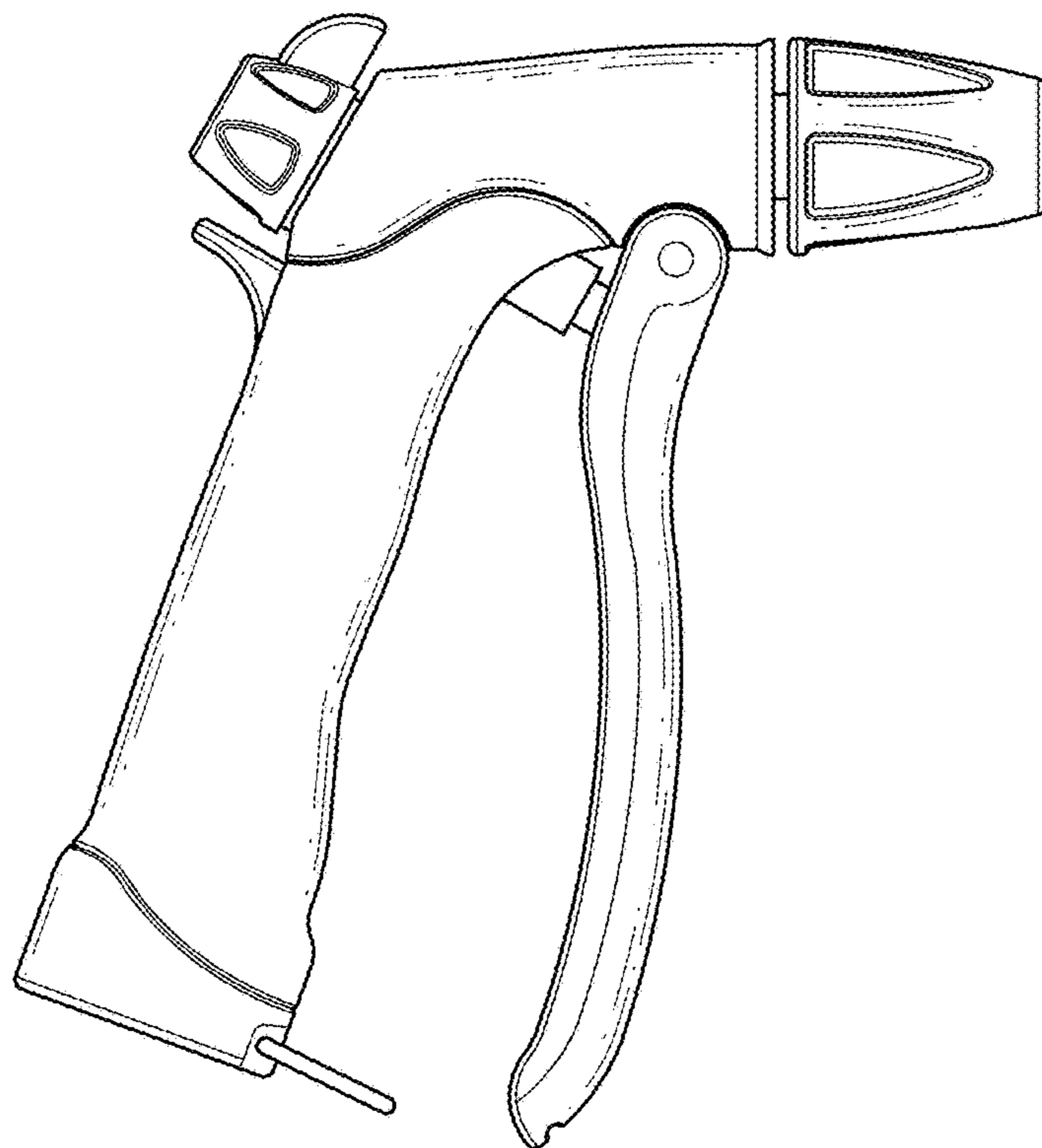

FIG. 3

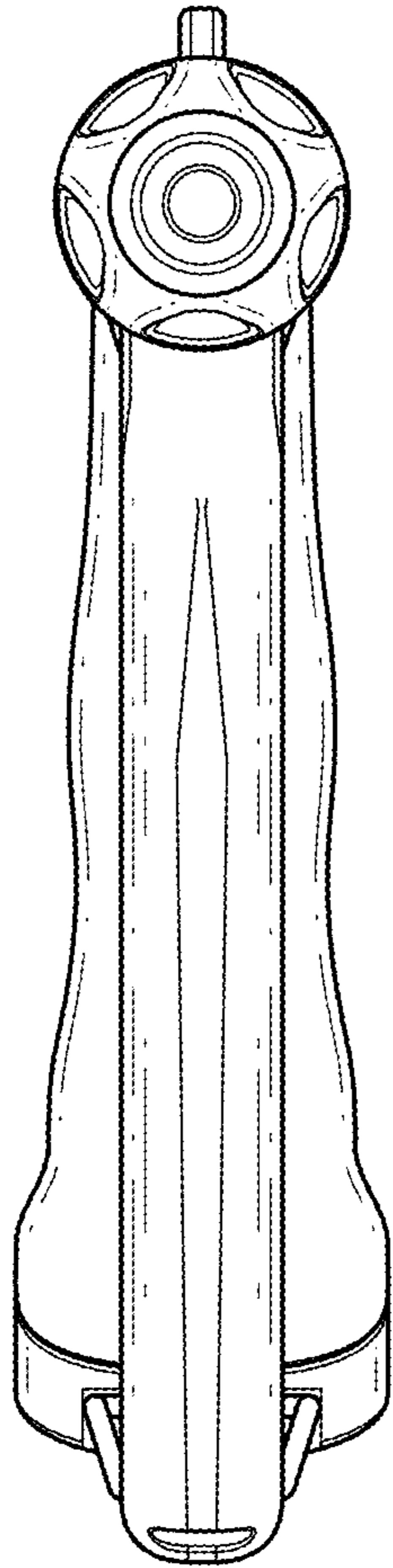

FIG. 4

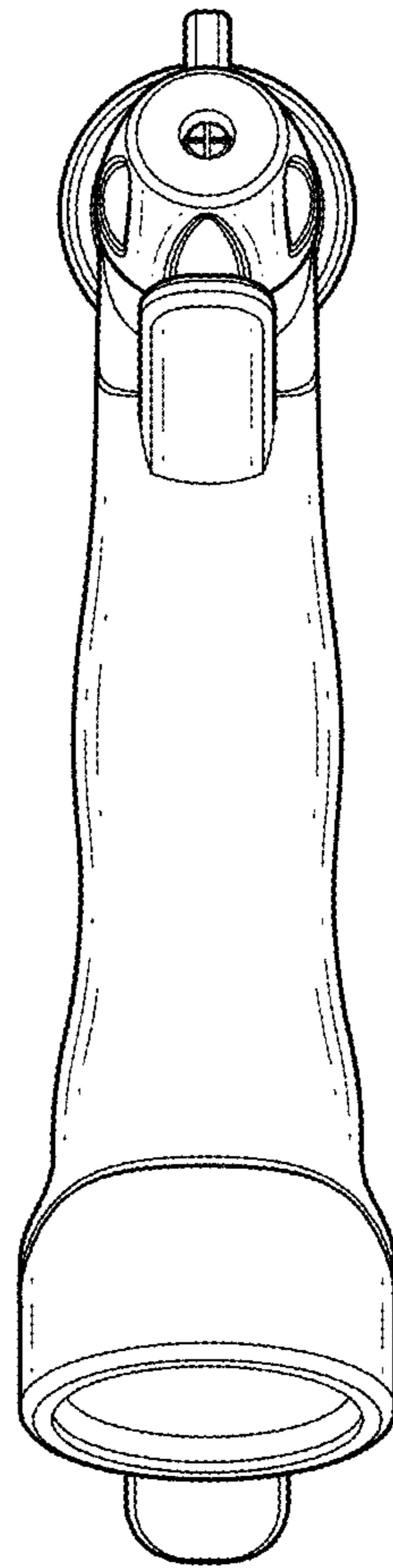

FIG. 5

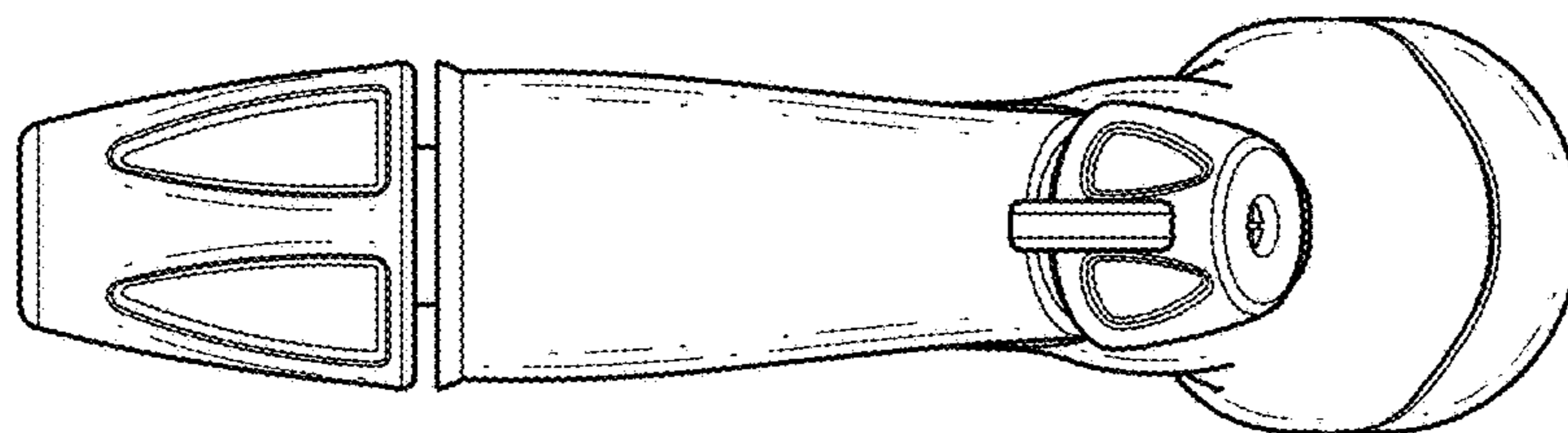

FIG. 6

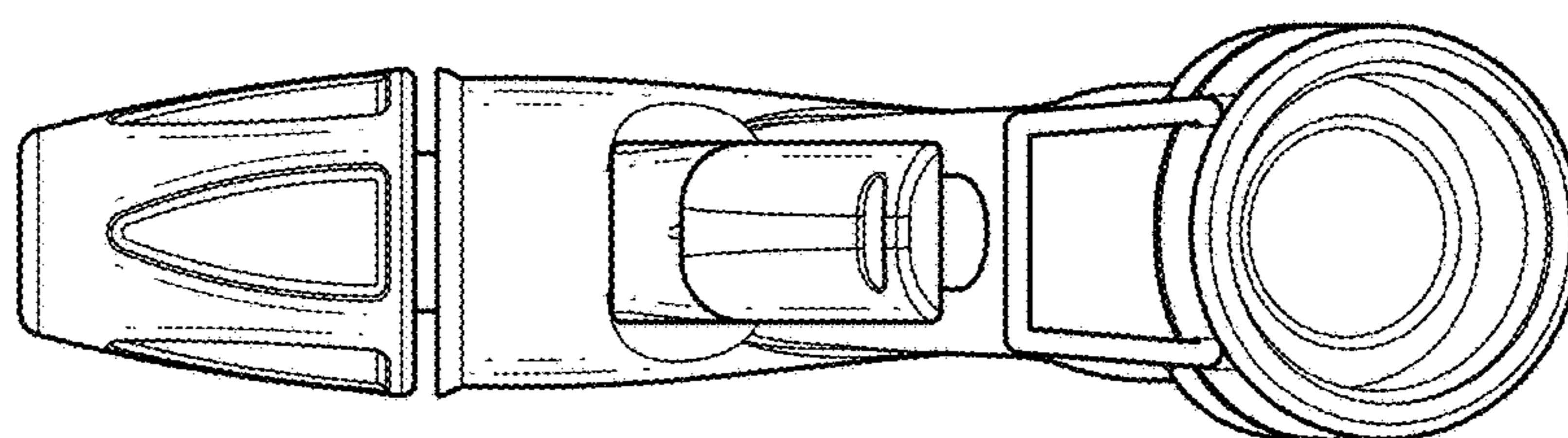

FIG. 7