



US00D783068S

(12) **United States Design Patent**  
**Popov**

(10) **Patent No.:** **US D783,068 S**

(45) **Date of Patent:** **\*\* Apr. 4, 2017**

(54) **GRINDING TOOL**

(71) Applicant: **Georgi M Popov**, Braselton, GA (US)

(72) Inventor: **Georgi M Popov**, Braselton, GA (US)

(\*\*) Term: **15 Years**

(21) Appl. No.: **29/570,353**

(22) Filed: **Jul. 7, 2016**

**Related U.S. Application Data**

(62) Division of application No. 29/510,880, filed on Dec. 4, 2014, now Pat. No. Des. 763,932.

(51) **LOC (10) Cl.** ..... **15-09**

(52) **U.S. Cl.**  
USPC ..... **D15/126**

(58) **Field of Classification Search**  
USPC ..... D8/70, 71, 90, 98; D15/125, 126, 138, D15/139; D21/485, 488, 499, 500, 503, D21/504; D25/103, 113–118  
CPC ..... B24D 5/02; B24D 5/06; B24D 7/06  
See application file for complete search history.

(56) **References Cited**

**U.S. PATENT DOCUMENTS**

5,453,041	A *	9/1995	Oliver	.....	B24D 5/06 451/541
5,575,707	A *	11/1996	Talieh	.....	B24B 21/00 451/168
5,782,682	A *	7/1998	Han	.....	B24B 7/22 451/527
6,106,382	A *	8/2000	Sakaguchi	.....	B24D 3/06 451/443
6,196,911	B1 *	3/2001	Preston	.....	B24D 7/06 451/527
D506,481	S *	6/2005	Olsen	.....	D15/126
D507,801	S *	7/2005	Olsen	.....	D15/126

D508,927	S *	8/2005	Olsen	.....	D15/126
6,933,018	B2 *	8/2005	Masuko	.....	B24B 13/01 427/282
D513,514	S *	1/2006	Olsen	.....	D15/139
D514,142	S *	1/2006	Olsen	.....	D15/139
D514,143	S *	1/2006	Olsen	.....	D15/139
D514,605	S *	2/2006	Olsen	.....	D15/139
D521,031	S *	5/2006	Thysell	.....	D15/126
D522,543	S *	6/2006	Thysell	.....	D15/126
D552,135	S *	10/2007	Olsen	.....	D15/139
D682,893	S *	5/2013	Bergstrand	.....	D15/126

(Continued)

*Primary Examiner* — Patricia Palasik

(57) **CLAIM**

The ornamental design for a grinding tool, as shown and described.

**DESCRIPTION**

FIG. 1 is a front perspective view of a grinding tool according to a first embodiment;  
 FIG. 2 is a bottom plan view thereof;  
 FIG. 3 is a front elevation view thereof;  
 FIG. 4 is a top plan view thereof;  
 FIG. 5 is a left side elevation view thereof;  
 FIG. 6 is a right side elevation view thereof;  
 FIG. 7 is a back side elevation view thereof;  
 FIG. 8 is a bottom perspective view thereof;  
 FIG. 9 is a front perspective view of a grinding tool according to a second embodiment;  
 FIG. 10 is a bottom plan view thereof;  
 FIG. 11 is a front elevation view thereof;  
 FIG. 12 is a top plan view thereof;  
 FIG. 13 is a left side elevation view thereof;  
 FIG. 14 is a right side elevation view thereof;  
 FIG. 15 is a back side elevation view thereof; and,  
 FIG. 16 is a bottom perspective view thereof.

**1 Claim, 2 Drawing Sheets**

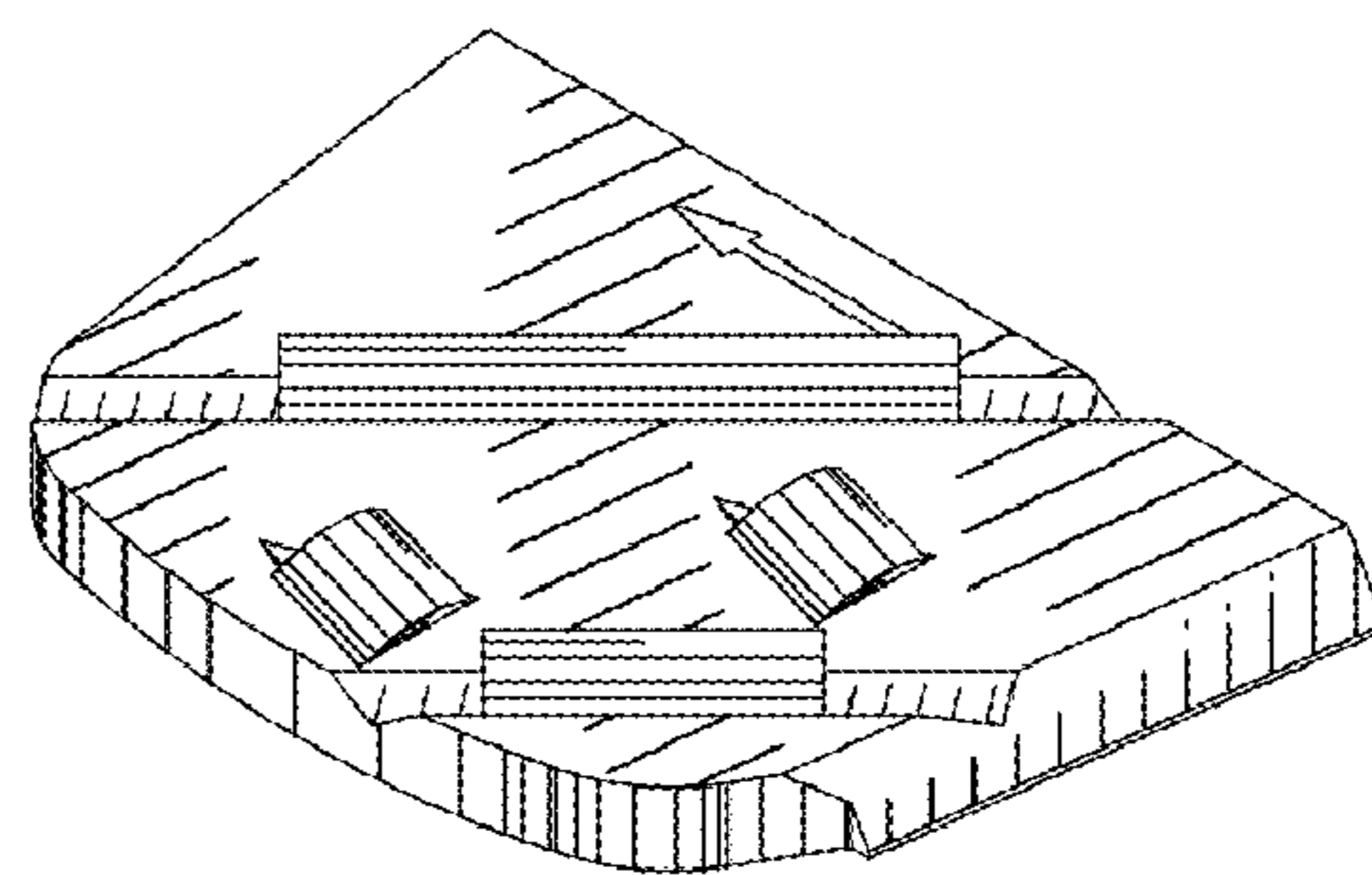
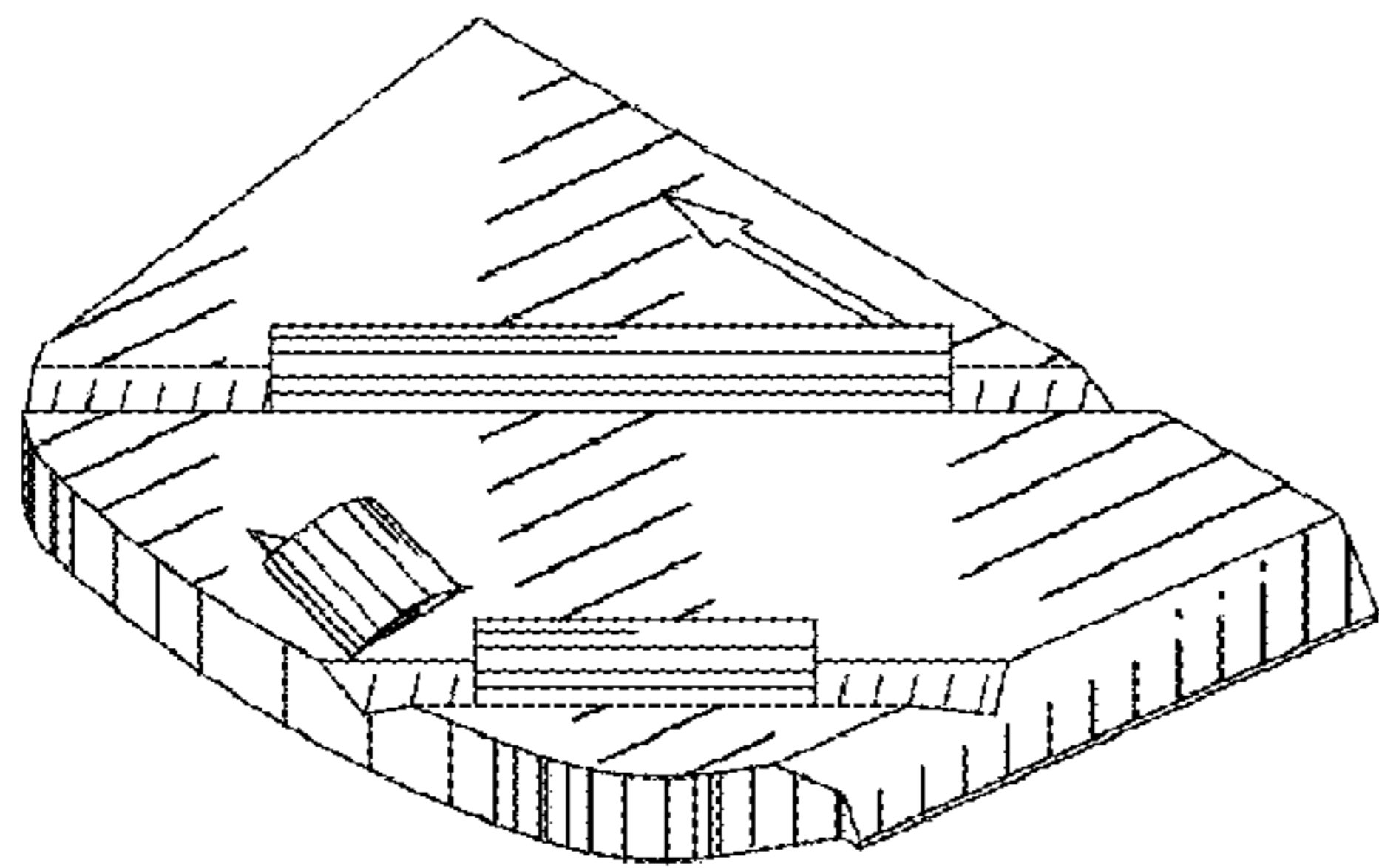

(56)

**References Cited**

U.S. PATENT DOCUMENTS

8,992,645 B2 \* 3/2015 Upadhyay ..... B24D 3/06  
51/293  
9,102,038 B2 \* 8/2015 Kinoshita ..... B24D 3/06

\* cited by examiner

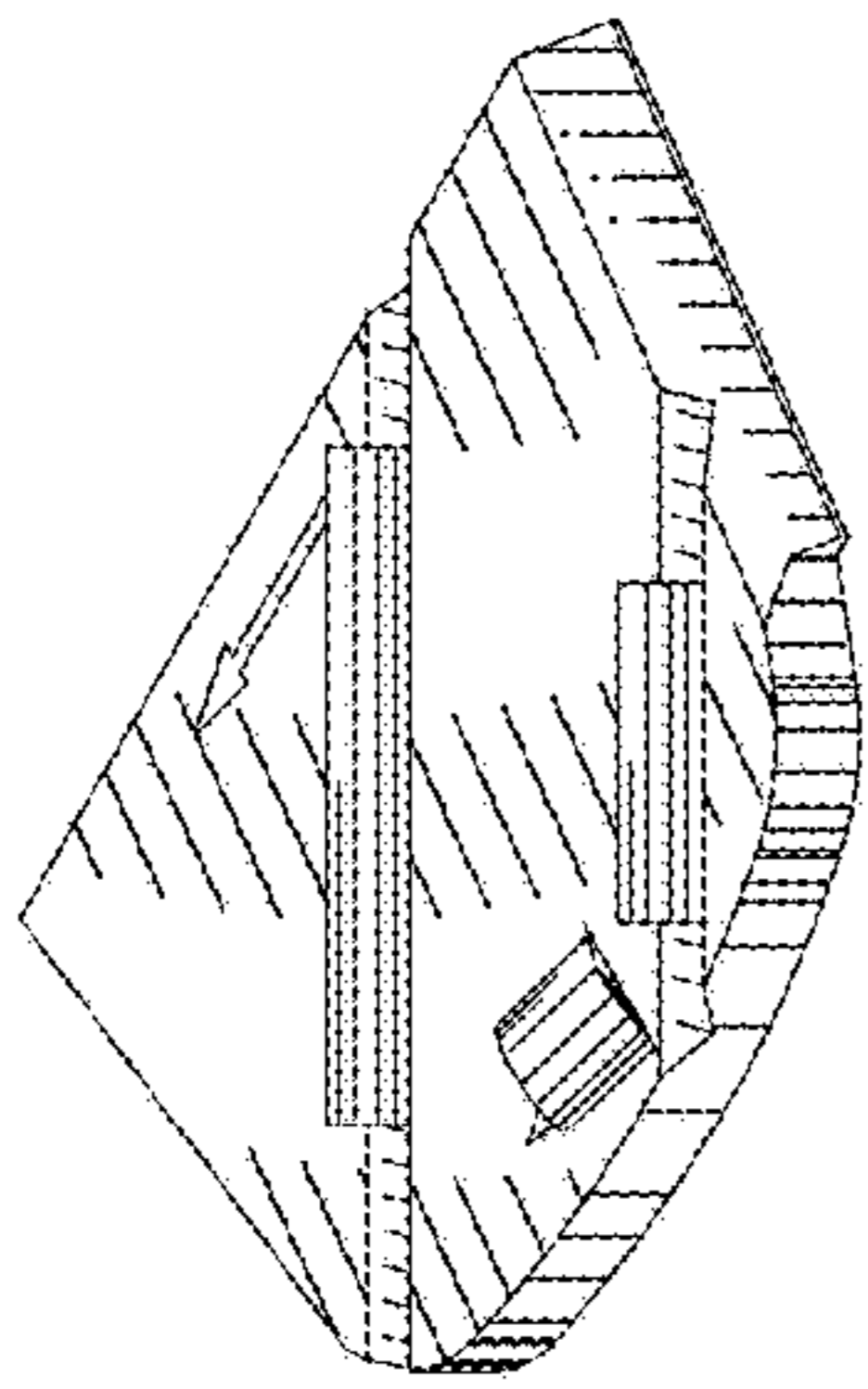

FIG. 1

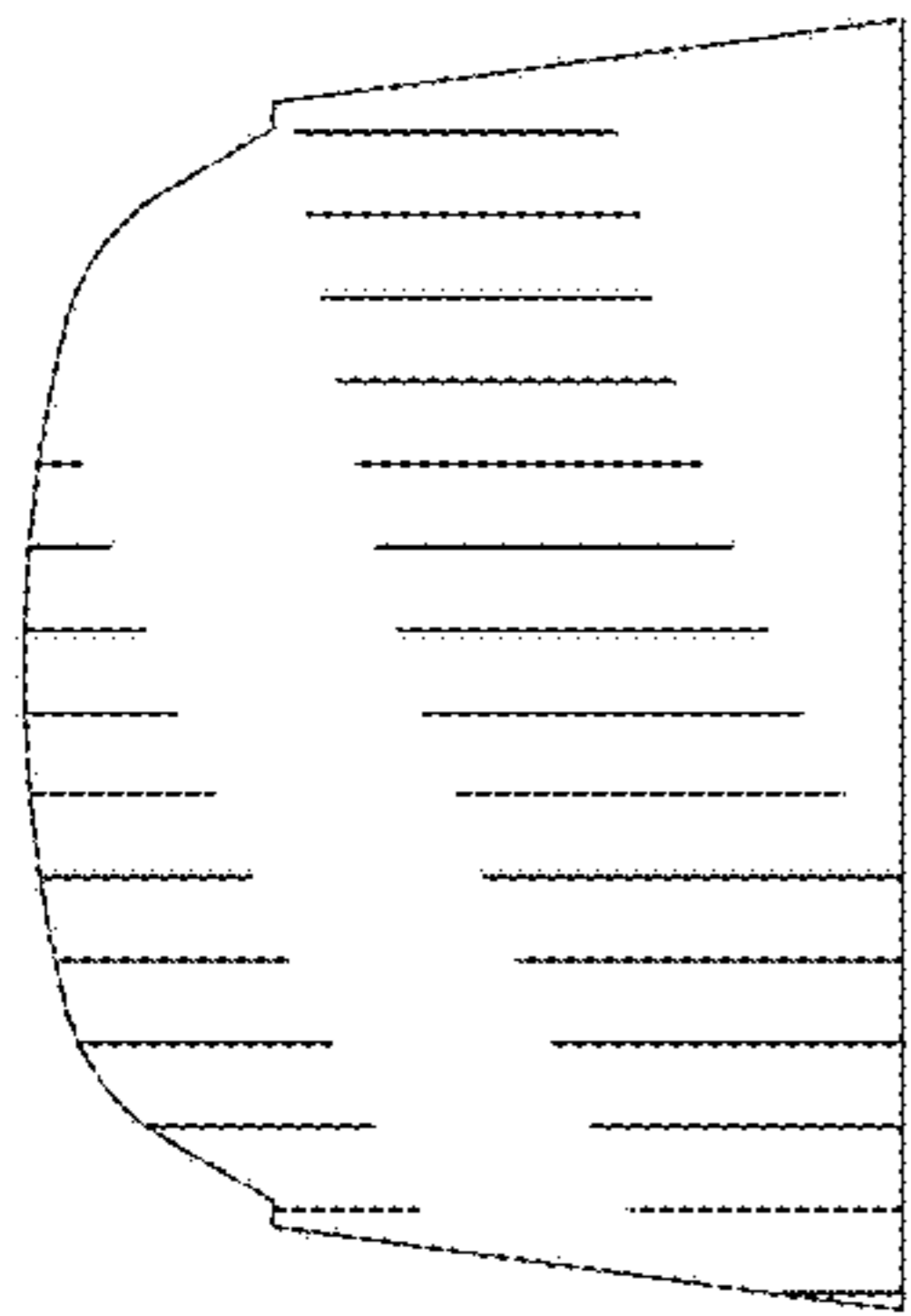

FIG. 2

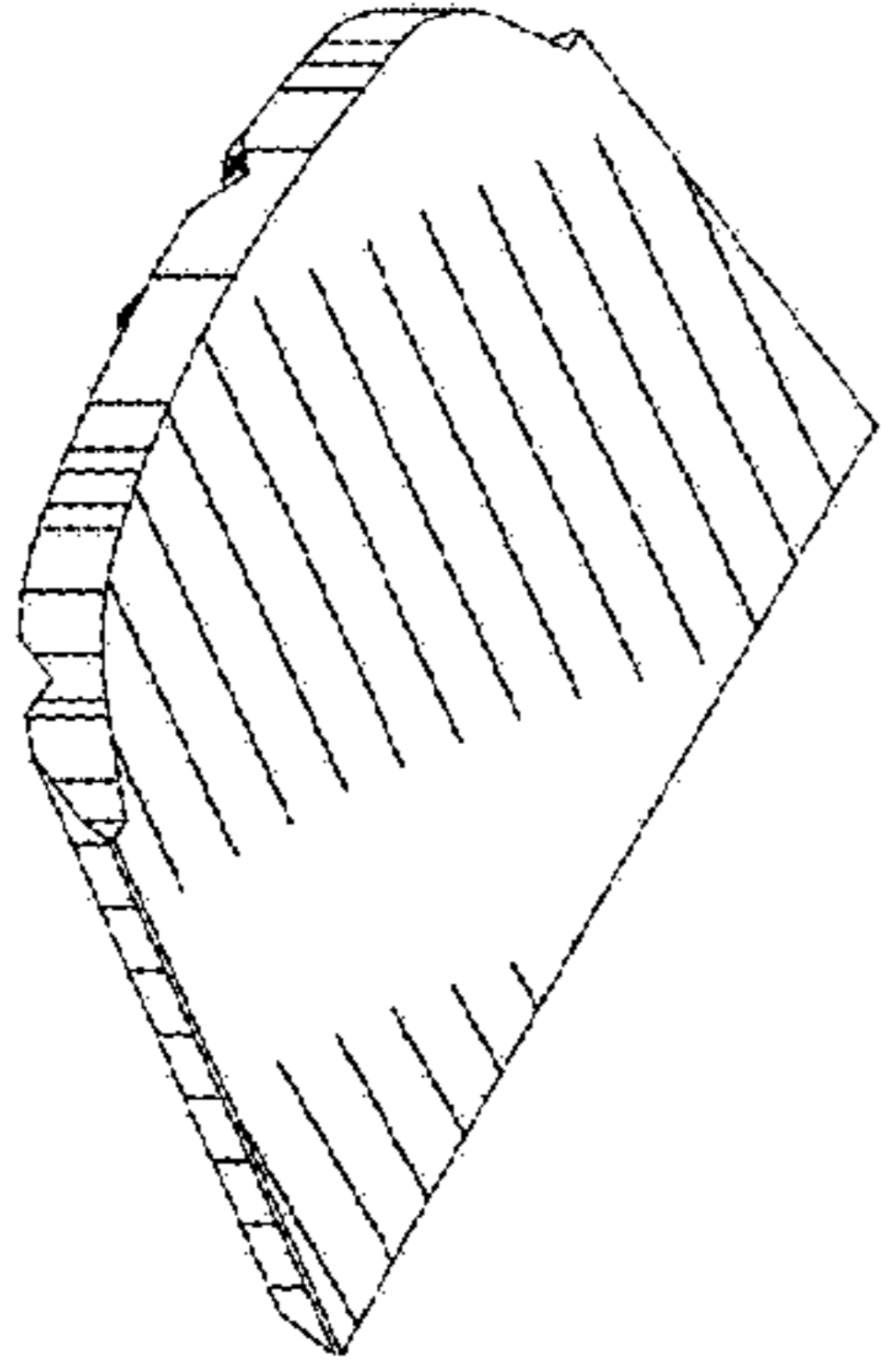

FIG. 8



FIG. 3

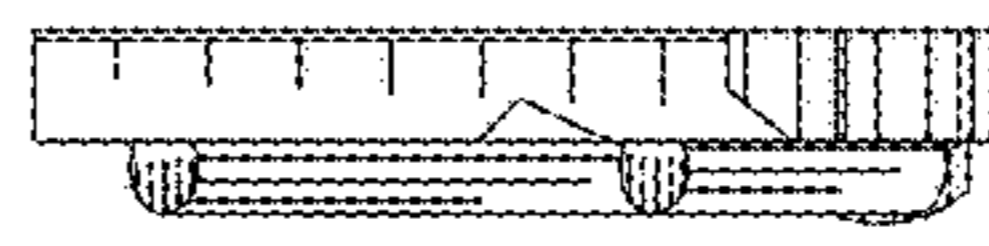

FIG. 5

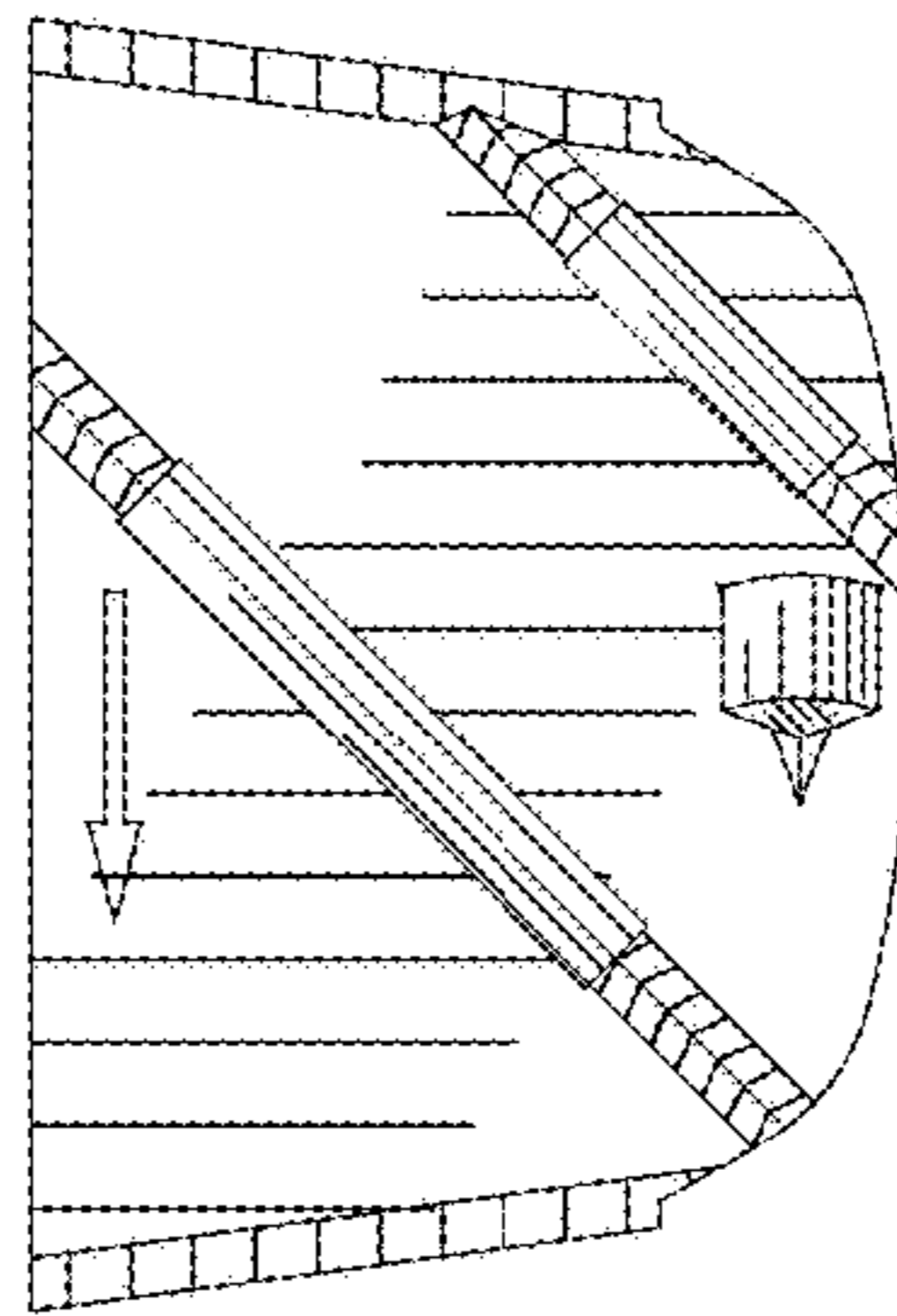

FIG. 4

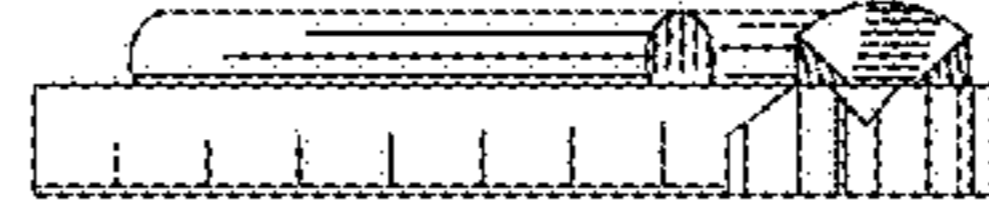

FIG. 6



FIG. 7

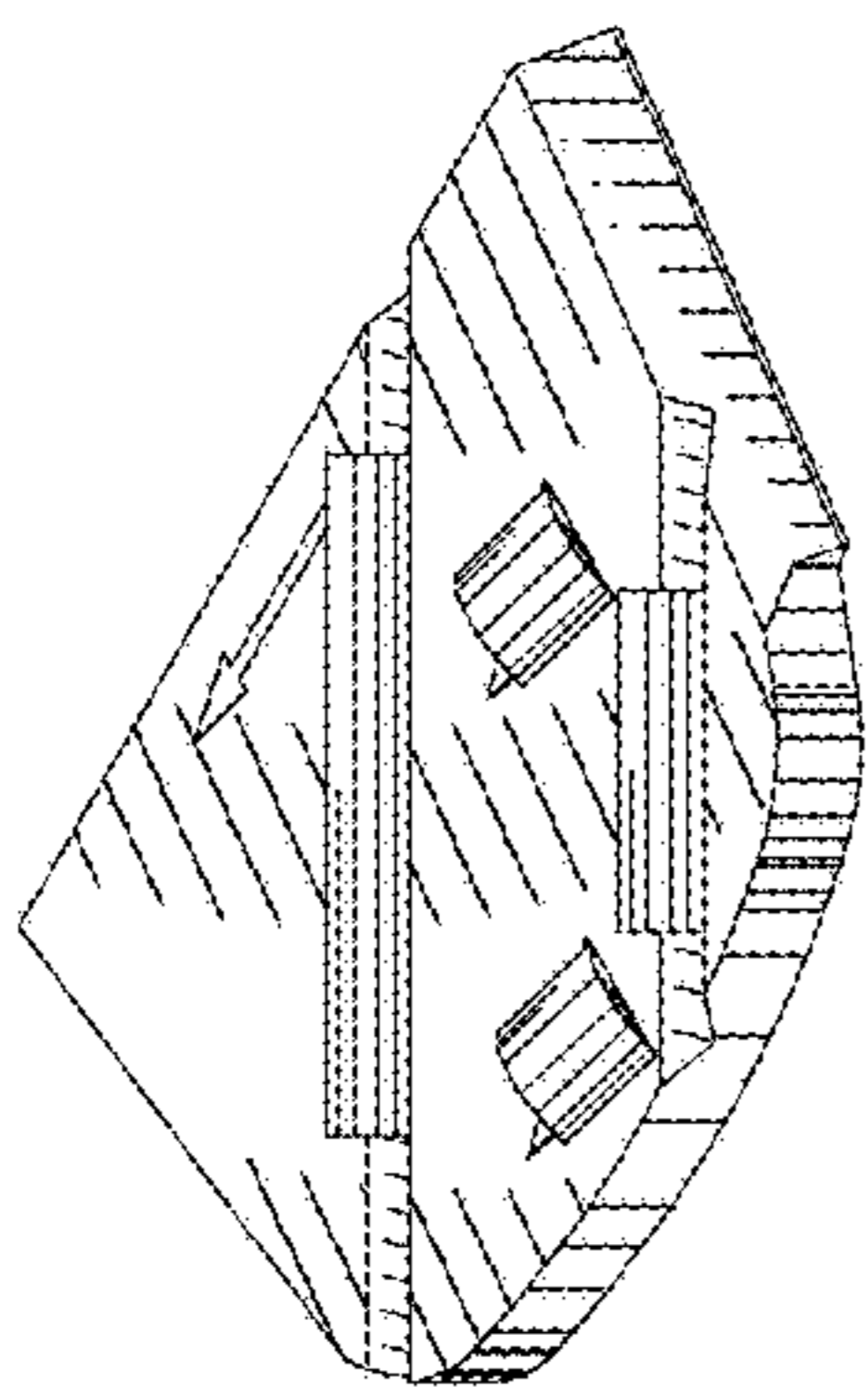

FIG. 9

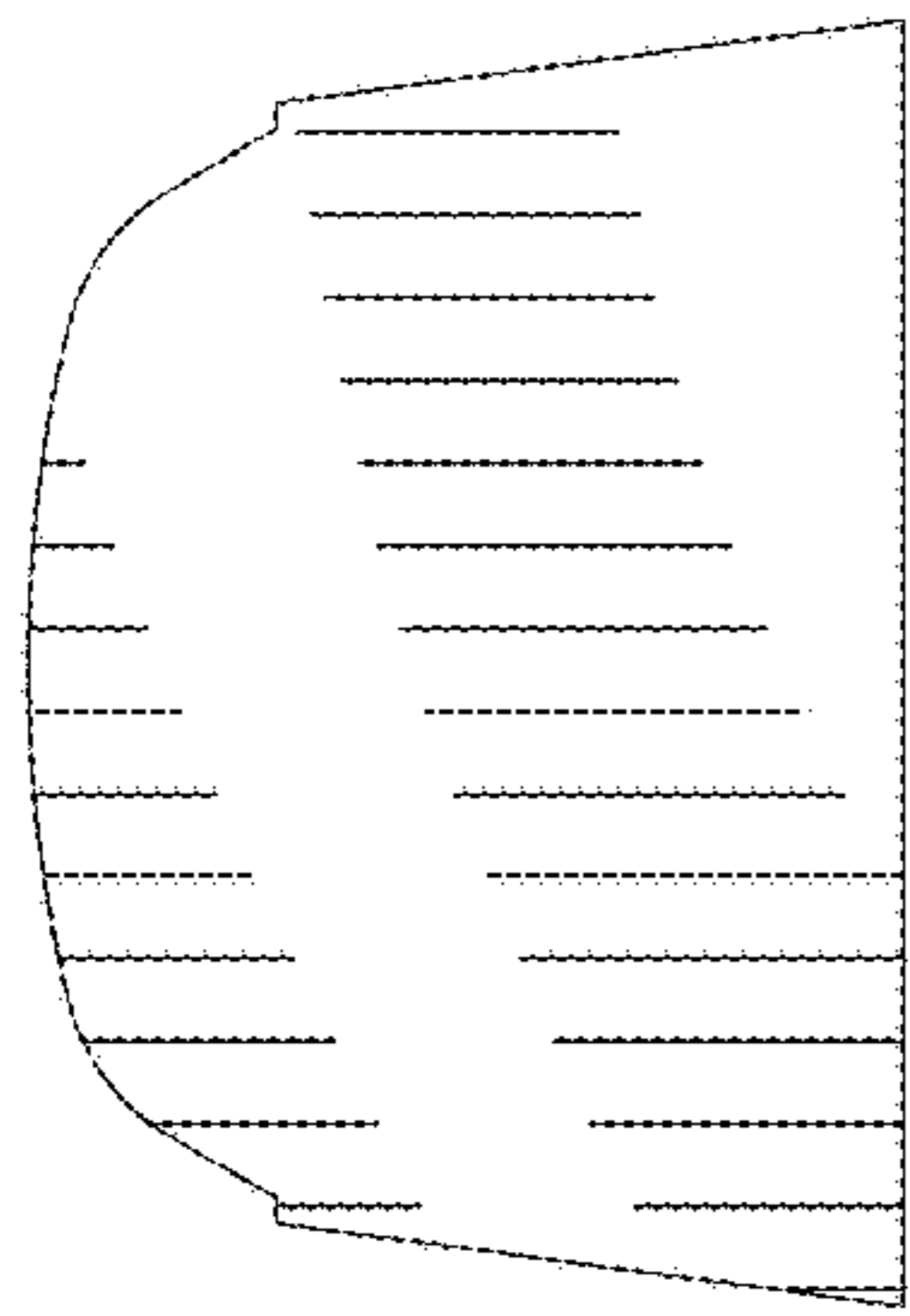

FIG. 10

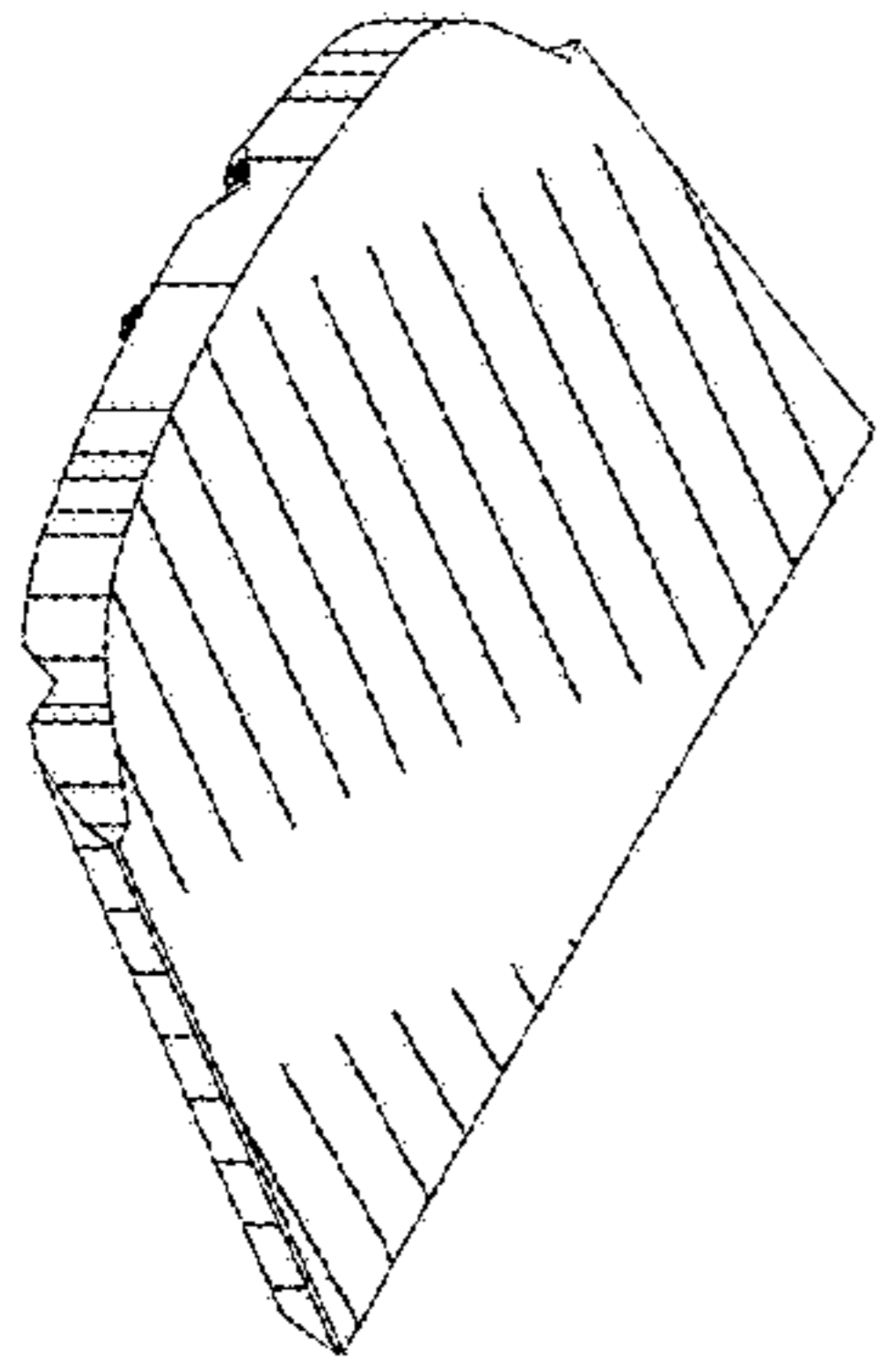

FIG. 16

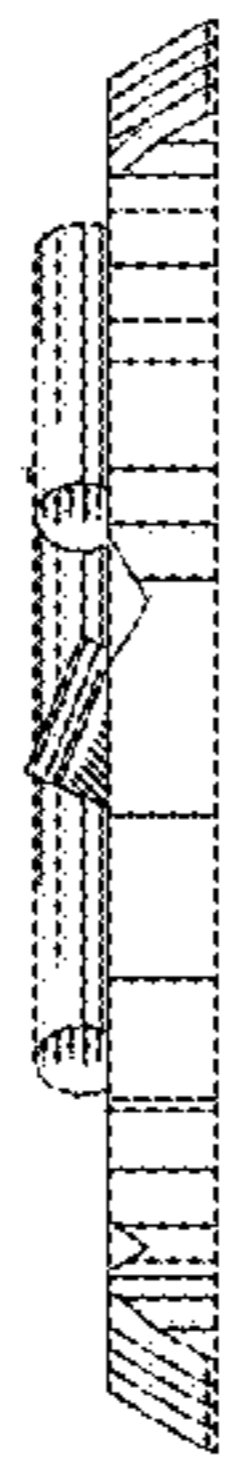

FIG. 11

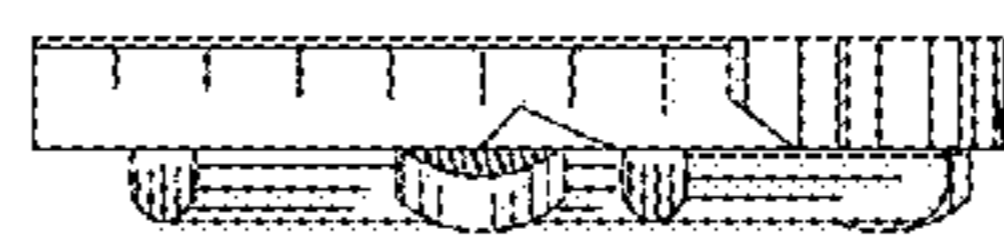

FIG. 13

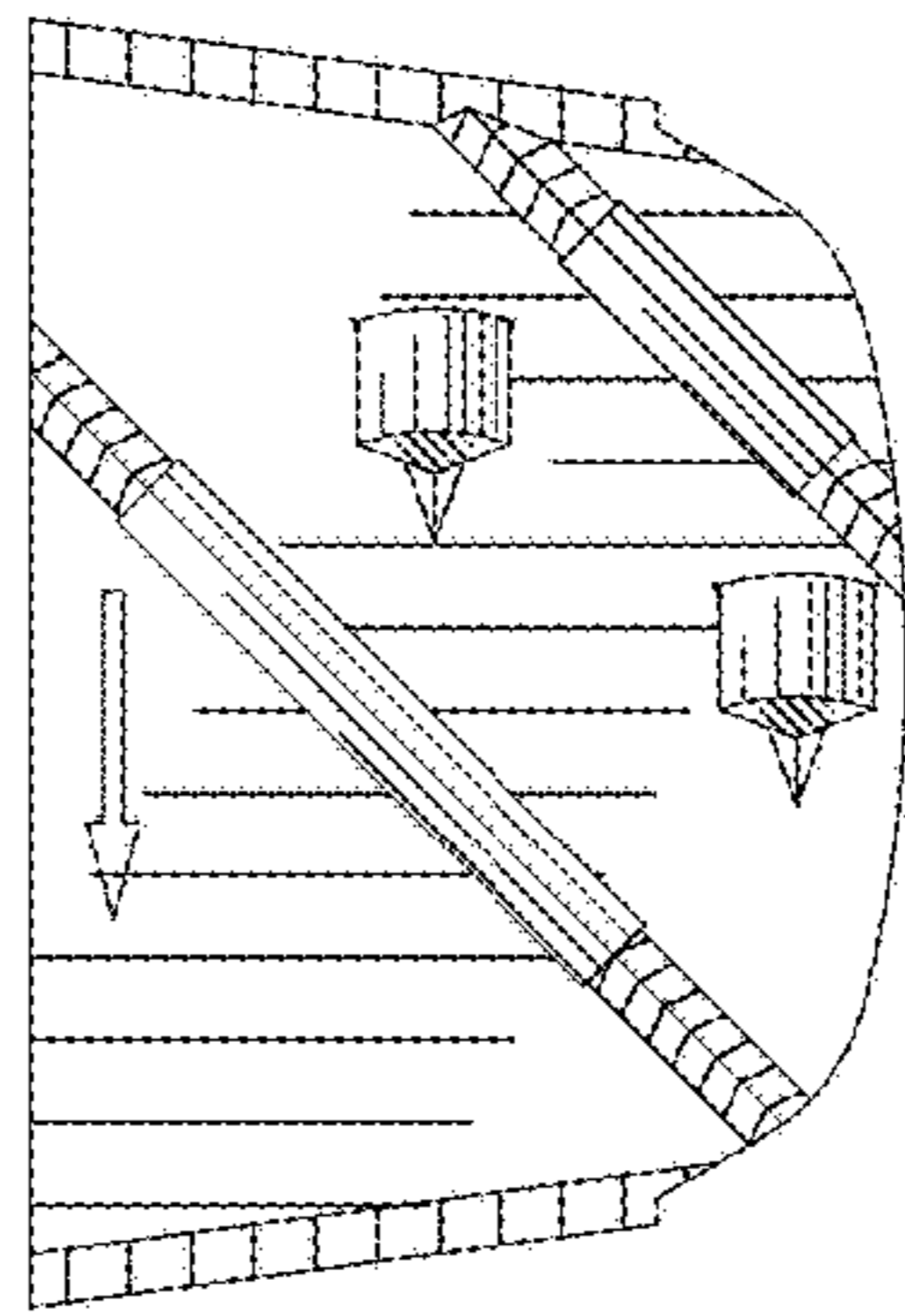

FIG. 12

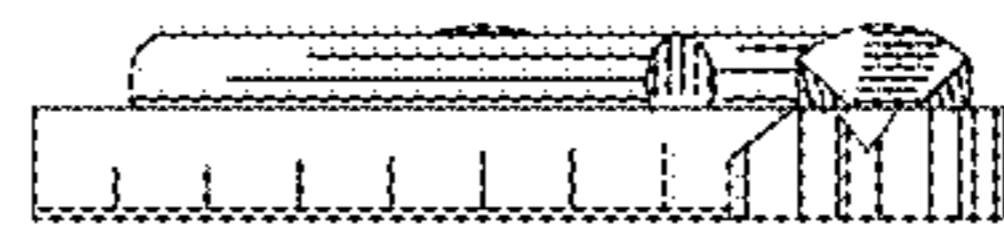

FIG. 14



FIG. 15