



US00D782930S

(12) **United States Design Patent**  
**Takakuwa et al.**

(10) **Patent No.:** **US D782,930 S**

(45) **Date of Patent:** **\*\* Apr. 4, 2017**

(54) **SENSOR MOUNT ASSEMBLY**

CPC .... F16B 2/00; F16B 2/005; F16B 2/02; F16B 2/04; F16B 2/06; F16B 2/065; F16B 2/08; F16B 2/10; F16B 2/12; F16B 2/14; F16B 2/16; F16B 2/18; F16B 2/185  
See application file for complete search history.

(71) Applicants: **Youji Takakuwa**, Tsukubamirai (JP);  
**Mitsuru Machijima**, Tsukubamirai (JP); **Kengo Monden**, Tsukubamirai (JP); **Seiichi Nagura**, Tsukubamirai (JP); **Kenta Onuki**, Tsukubamirai (JP)

(56) **References Cited**

U.S. PATENT DOCUMENTS

9,512,714 B2\* 12/2016 Sobolewski ..... E21B 47/01

\* cited by examiner

*Primary Examiner* — Antoine D Davis  
(74) *Attorney, Agent, or Firm* — Yokoi & Co., U.S.A.;  
Toshiyuki Yokoi

(72) Inventors: **Youji Takakuwa**, Tsukubamirai (JP);  
**Mitsuru Machijima**, Tsukubamirai (JP); **Kengo Monden**, Tsukubamirai (JP); **Seiichi Nagura**, Tsukubamirai (JP); **Kenta Onuki**, Tsukubamirai (JP)

(57) **CLAIM**

(73) Assignee: **SMC Corporation**, Chiyoda-ku, Tokyo (JP)

The ornamental design for a sensor mount assembly, as shown and described.

(\*\*) Term: **15 Years**

**DESCRIPTION**

(21) Appl. No.: **29/559,571**

FIG. 1 shows a front view of a sensor mount assembly showing our new design;  
FIG. 2 shows a rear view thereof;  
FIG. 3 shows a right side view thereof;  
FIG. 4 shows a left side view thereof;  
FIG. 5 shows a top view thereof;  
FIG. 6 shows a bottom view thereof; and,  
FIG. 7 shows a top, front and right side perspective view thereof.

(22) Filed: **Mar. 30, 2016**

(30) **Foreign Application Priority Data**

Oct. 9, 2015 (JP) ..... 2015-022301

(51) **LOC (10) Cl.** ..... **10-04**

(52) **U.S. Cl.**  
USPC ..... **D10/103; D8/394**

(58) **Field of Classification Search**  
USPC ..... D8/73, 394, 396; D10/74, 103; D15/141

**1 Claim, 7 Drawing Sheets**

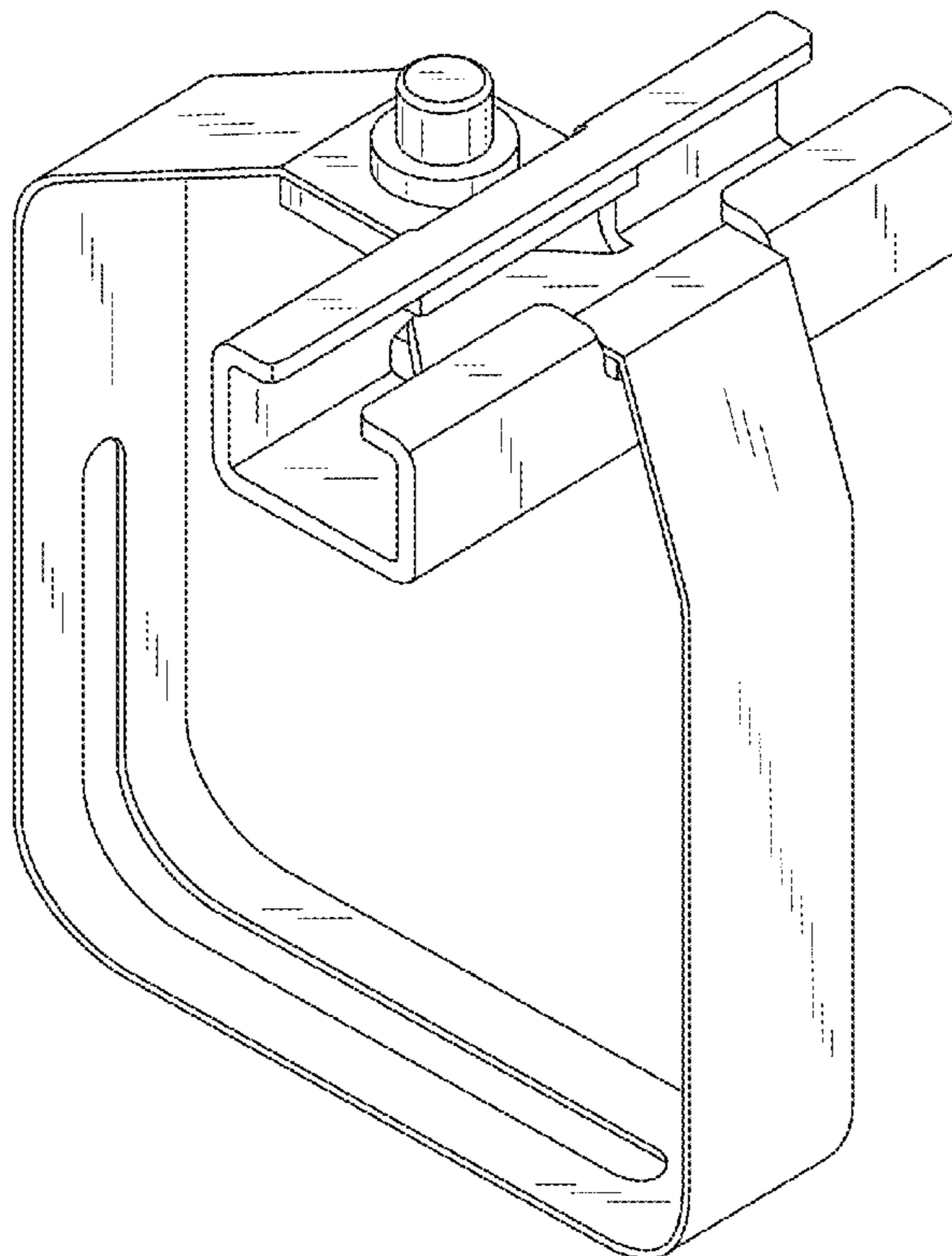

FIG. 1

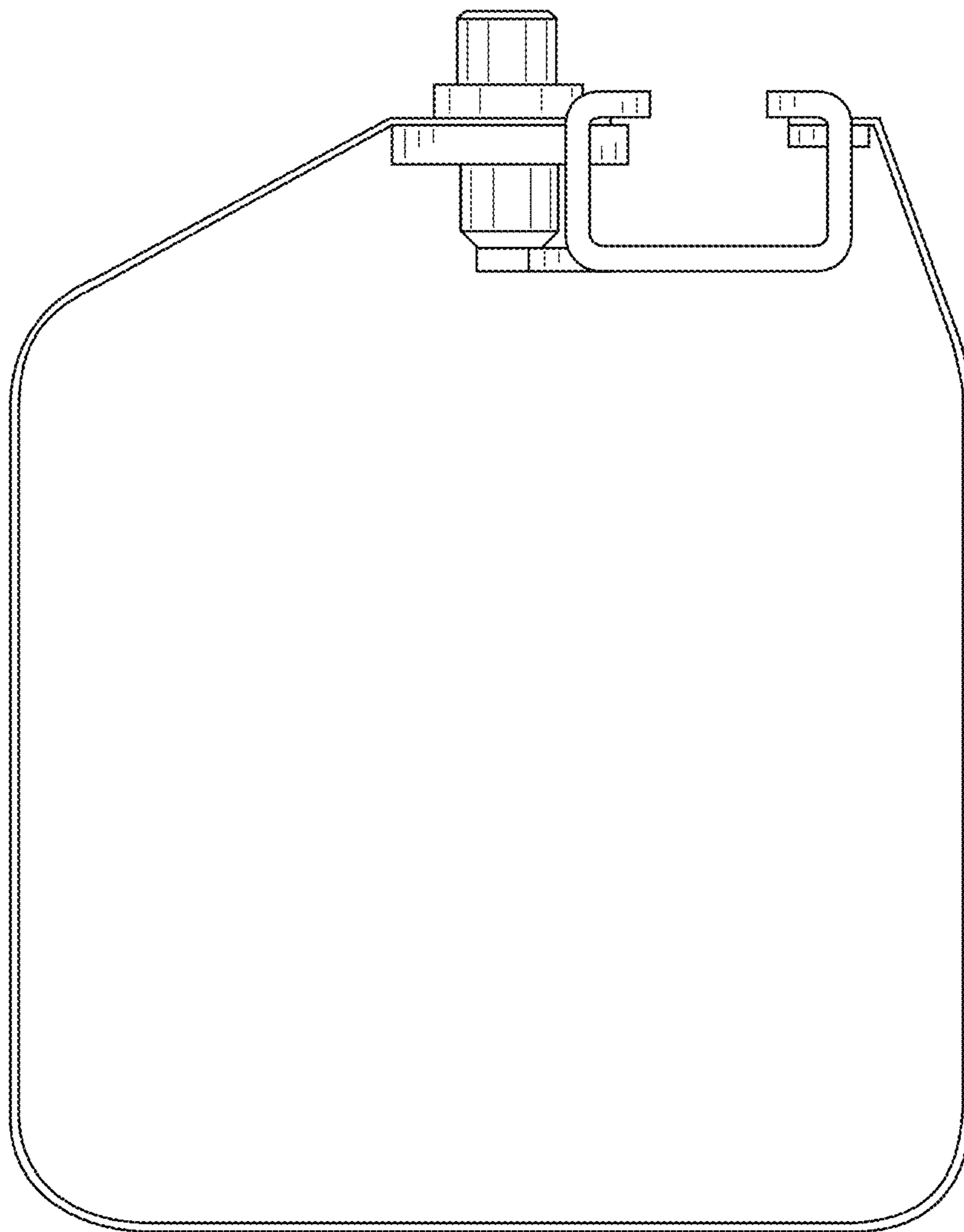

FIG. 2

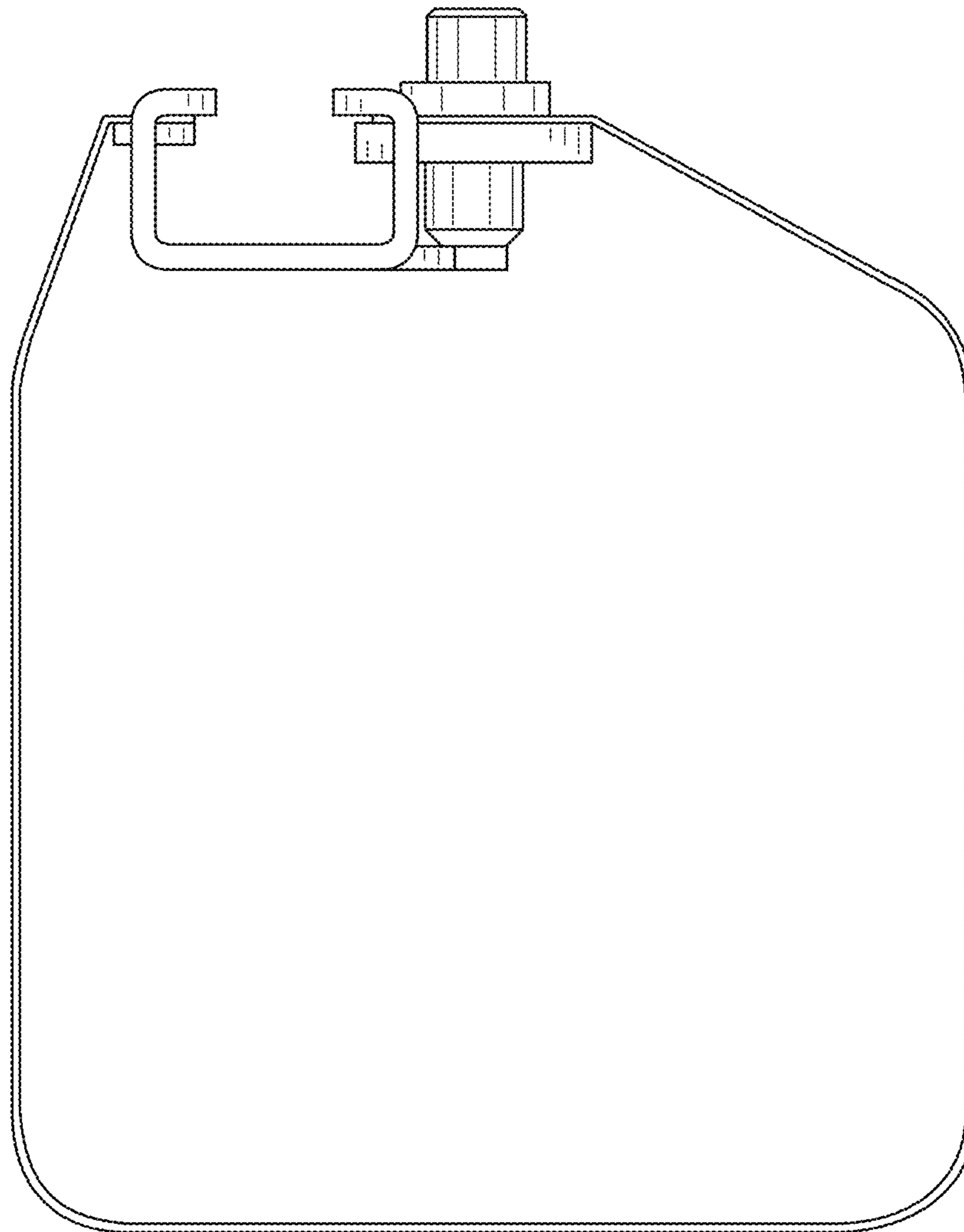

FIG. 3

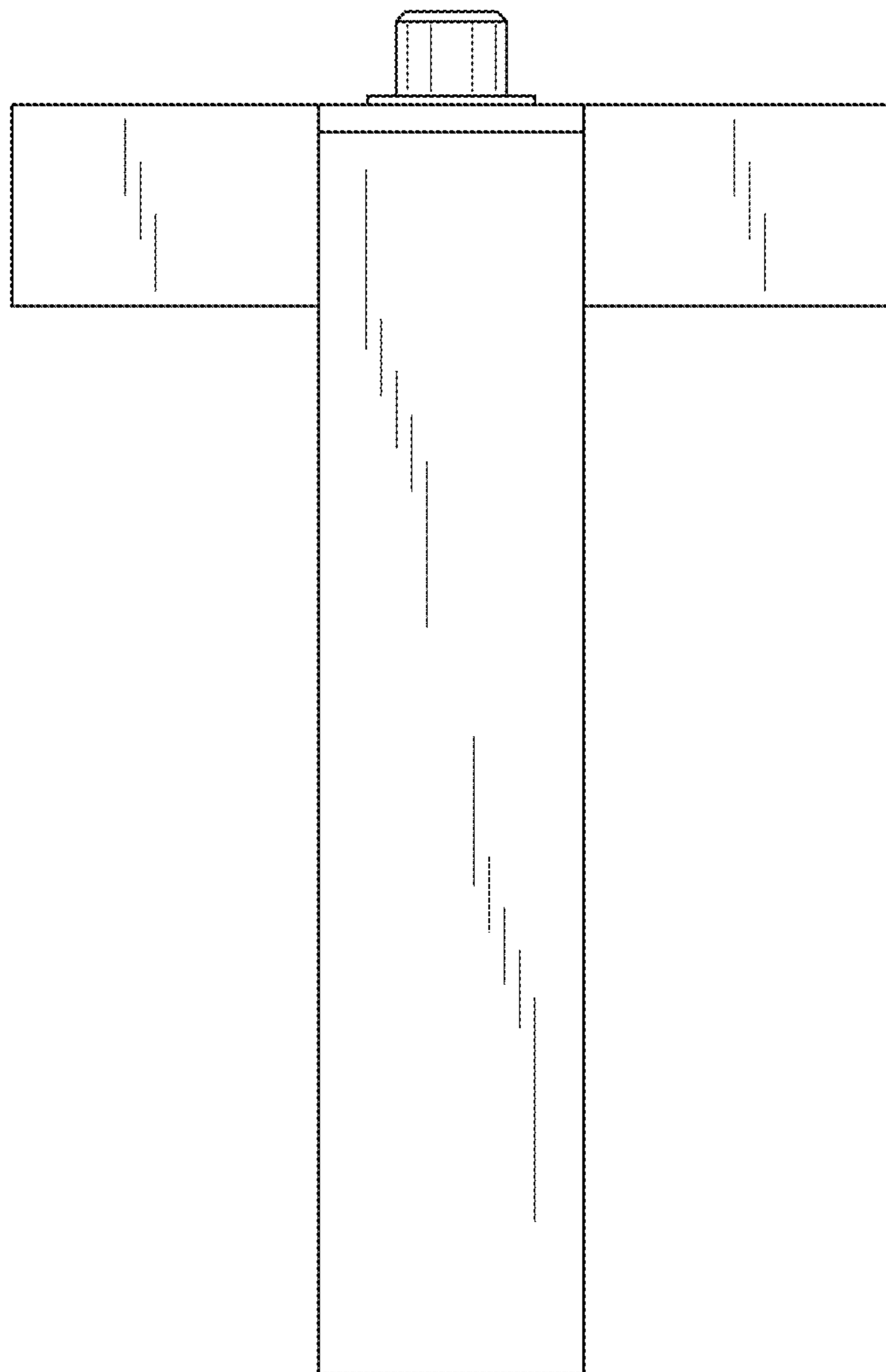

FIG. 4

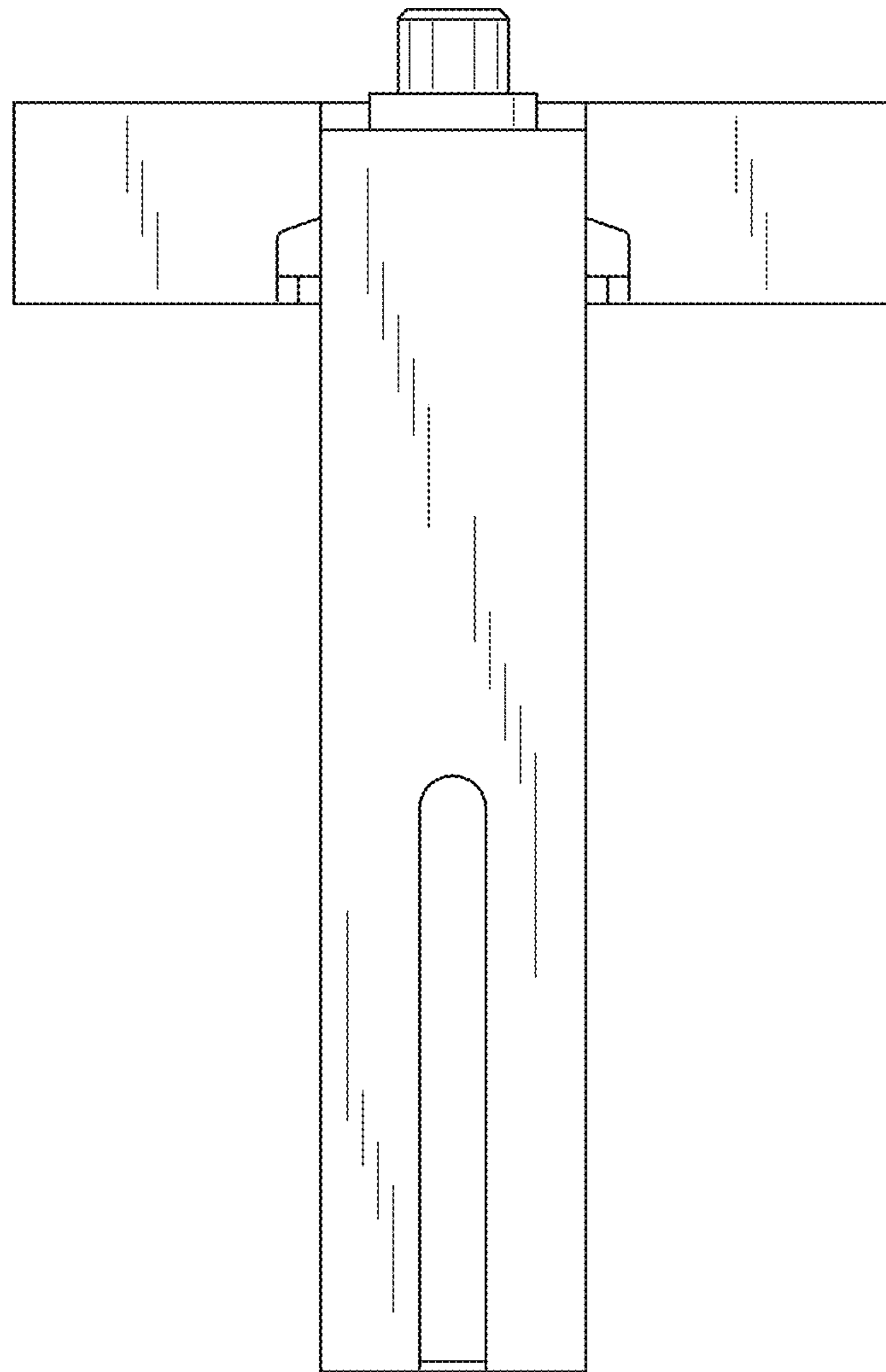

FIG. 5

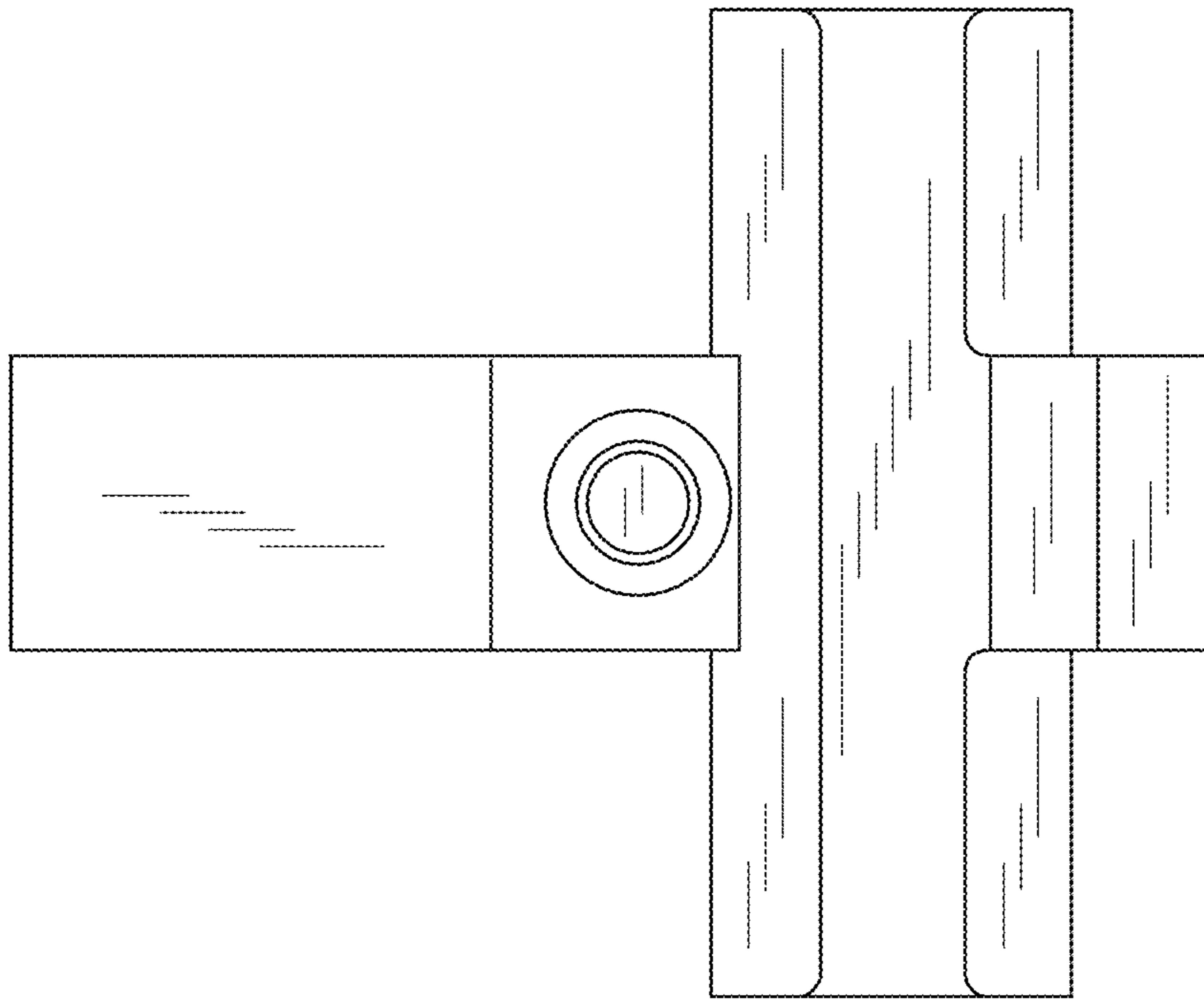

FIG. 6

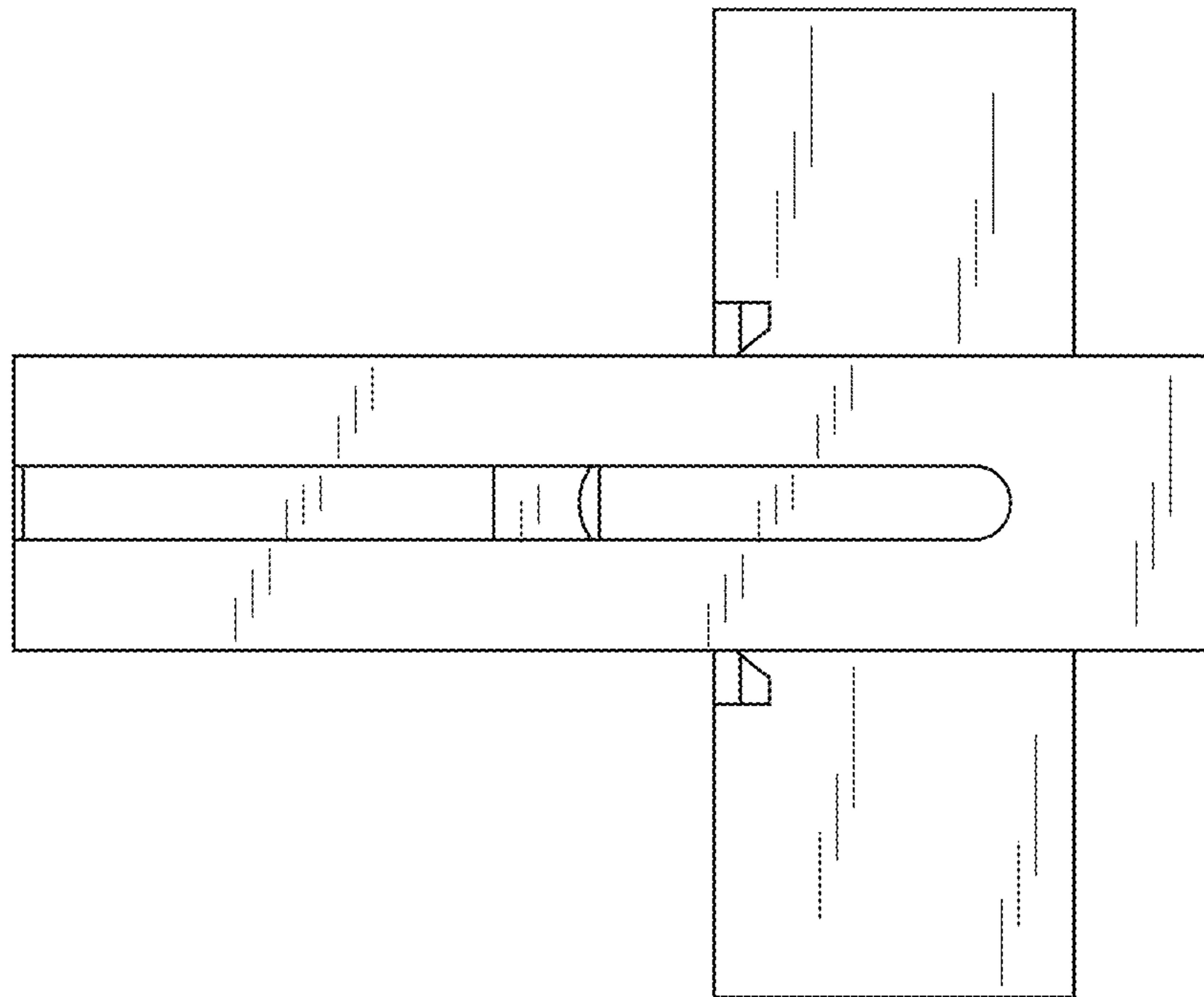

FIG. 7

