



US00D782730S

(12) **United States Design Patent**
Zhang et al.

(10) **Patent No.:** **US D782,730 S**
(45) **Date of Patent:** **** Mar. 28, 2017**

(54) **COSMETIC APPLICATOR**

DESCRIPTION

- (71) Applicants: **Yuhan Zhang**, Sichuan (CN); **Martti Johannes Lampela**, Woodland Hills, CA (US); **Carlos Barreto**, New York, NY (US)
- (72) Inventors: **Yuhan Zhang**, Sichuan (CN); **Martti Johannes Lampela**, Woodland Hills, CA (US); **Carlos Barreto**, New York, NY (US)
- (73) Assignee: **Revlon Consumer Products Corporation**, New York, NY (US)
- (**) Term: **15 Years**
- (21) Appl. No.: **29/537,925**
- (22) Filed: **Aug. 31, 2015**
- (51) **LOC (10) Cl.** **28-02**
- (52) **U.S. Cl.**
USPC **D28/7**
- (58) **Field of Classification Search**
USPC ... D32/40, 52; D28/7, 8, 20, 21, 22, 30, 31, D28/76, 99; D4/114, 116, 127, 129,
(Continued)

(56) **References Cited**

U.S. PATENT DOCUMENTS

- D53,980 S * 11/1919 Behrman D4/127
 - D151,483 S * 10/1948 Alderson D4/104
- (Continued)

Primary Examiner — Sheryl Lane
Assistant Examiner — Calvin E VanSant
(74) *Attorney, Agent, or Firm* — Revlon

(57) **CLAIM**

We claim the ornamental design for a cosmetic applicator, substantially as shown and described.

FIG. 1 is a perspective view of cosmetic applicator showing the new design;
 FIG. 2 is a front elevational view thereof;
 FIG. 3 is a back elevational view thereof;
 FIG. 4 is a right side elevational view thereof;
 FIG. 5 is a left side elevational view thereof;
 FIG. 6 is a bottom view thereof;
 FIG. 7 is a top view thereof;
 FIG. 8 is a perspective view of the second embodiment of the cosmetic applicator;
 FIG. 9 is a front elevational view of the second embodiment of the cosmetic applicator;
 FIG. 10 is a back elevational view of the second embodiment of the cosmetic applicator;
 FIG. 11 is a right side elevational view of the second embodiment of the cosmetic applicator;
 FIG. 12 is a left side elevational view of the second embodiment of the cosmetic applicator;
 FIG. 13 is a bottom view of the second embodiment of the cosmetic applicator;
 FIG. 14 is a top view of the second embodiment of the cosmetic applicator;
 FIG. 15 is a perspective view of the third embodiment of the cosmetic applicator;
 FIG. 16 is a front elevational view of the third embodiment of the cosmetic applicator;
 FIG. 17 is a back elevational view of the third embodiment of the cosmetic applicator;
 FIG. 18 is a right side elevational view of the third embodiment of the cosmetic applicator;
 FIG. 19 is a left side elevational view of the third embodiment of the cosmetic applicator;
 FIG. 20 is a bottom view of the third embodiment of the cosmetic applicator; and,
 FIG. 21 is a top view of the third embodiment of the cosmetic applicator.

The broken lines shown in the drawings are for the purpose of illustrating portions of a part of the cosmetic applicator and form no part of the claimed design.

1 Claim, 8 Drawing Sheets

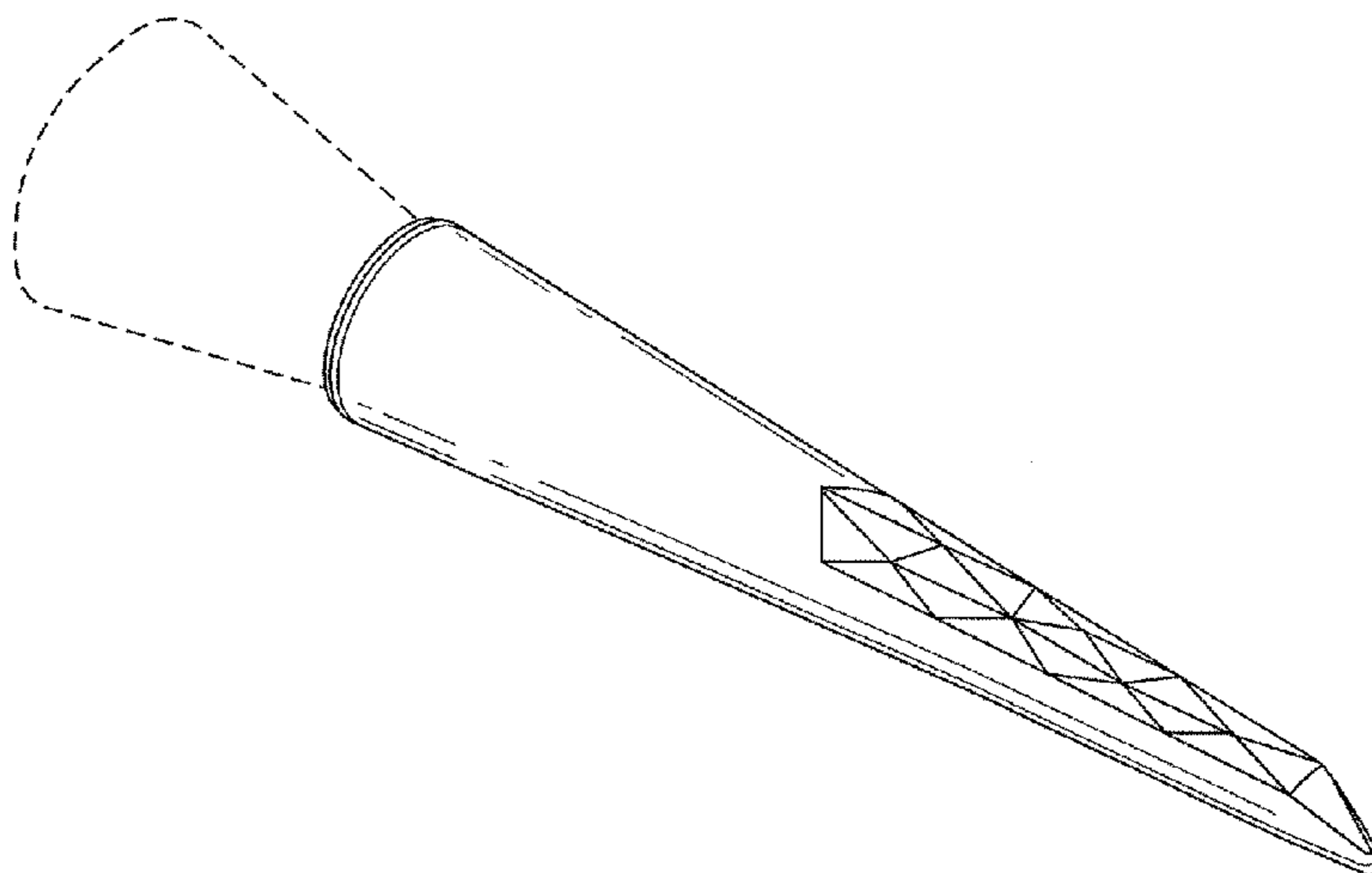

(58) **Field of Classification Search**

USPC D4/132-138; 15/209.1, 210.1, 244.1;
D19/109

CPC A61H 7/002; A61H 7/003; A46B 2200/1046;
A45D 33/34; A45D 33/36; A47L 23/05;
A47K 7/02; A47K 7/03; A47K 7/028;
A61M 35/003

See application file for complete search history.

(56) **References Cited**

U.S. PATENT DOCUMENTS

3,103,032 A * 9/1963 Brenne A45D 40/265
132/317
D258,241 S * 2/1981 Takada D4/135
D283,852 S * 5/1986 Hsu D4/136
D320,698 S * 10/1991 Reich D4/135
D378,026 S * 2/1997 Balazs D28/7
6,601,257 B1 * 8/2003 Felix-Flender A46B 9/02
15/160
D483,572 S * 12/2003 Fong D4/128
D484,704 S * 1/2004 Fong D4/133
D677,060 S * 3/2013 Floyd D4/127
D756,127 S * 5/2016 Nicoline D28/7

* cited by examiner

FIG. 1

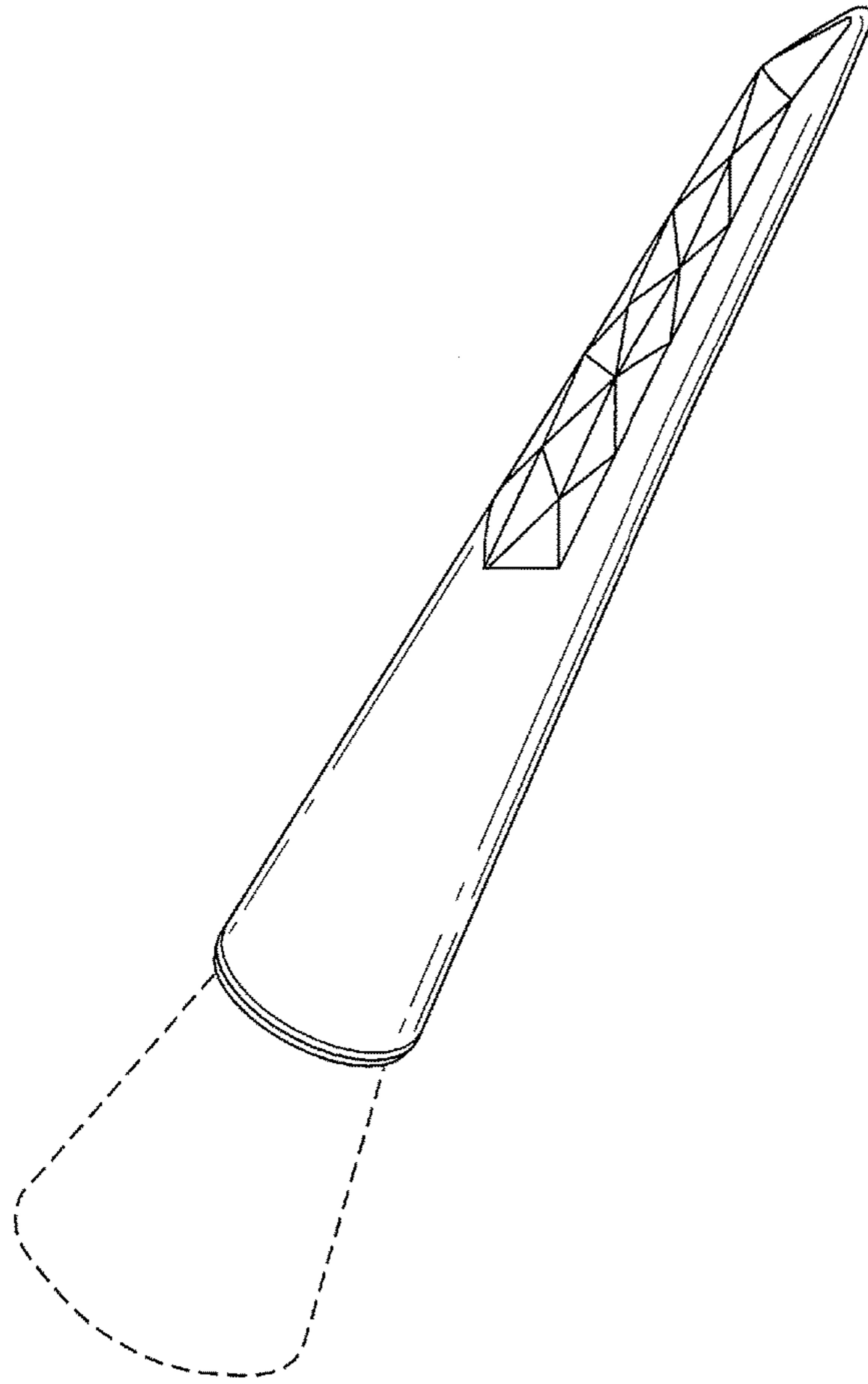

FIG. 2

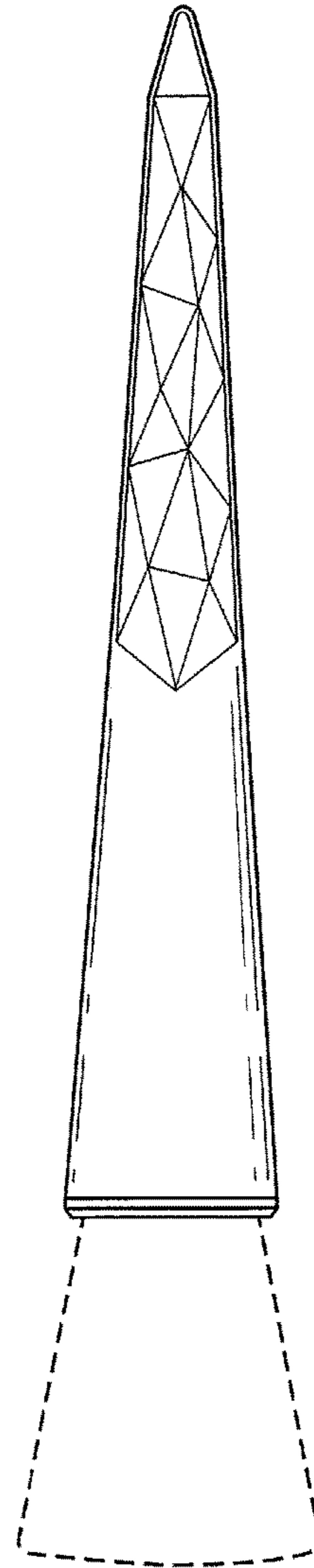

FIG. 3

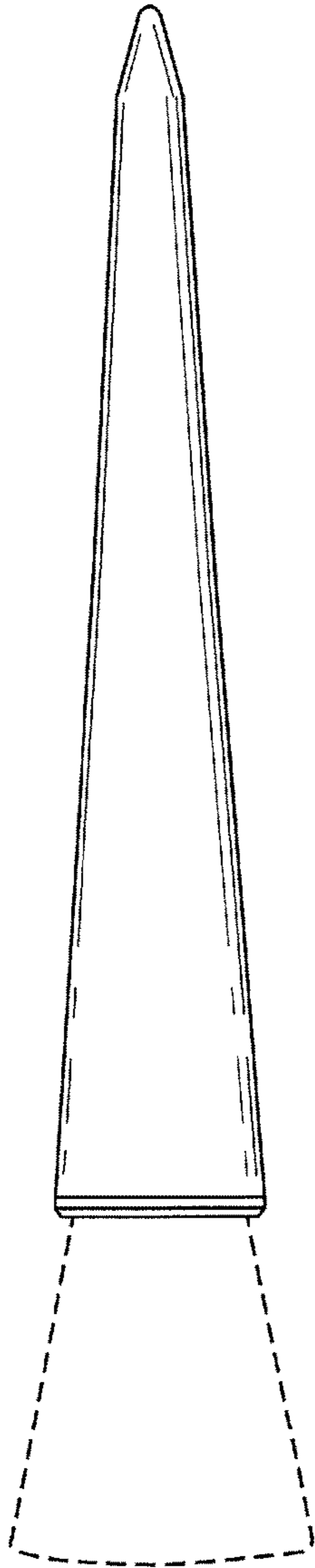

FIG. 4

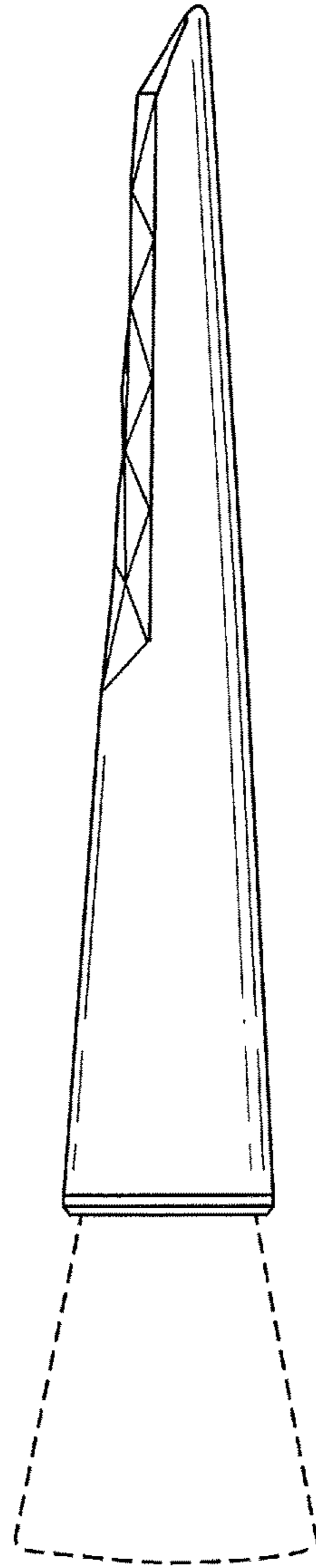

FIG. 5

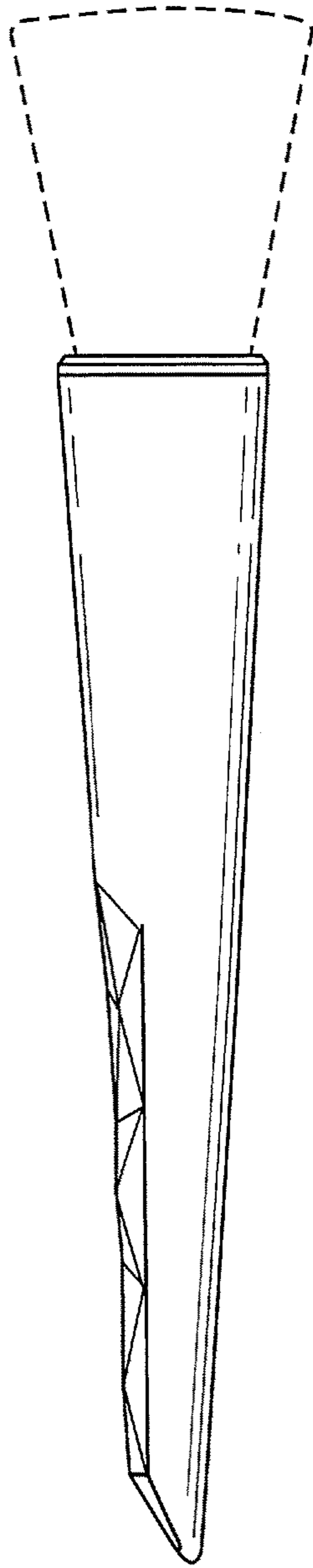

FIG. 6

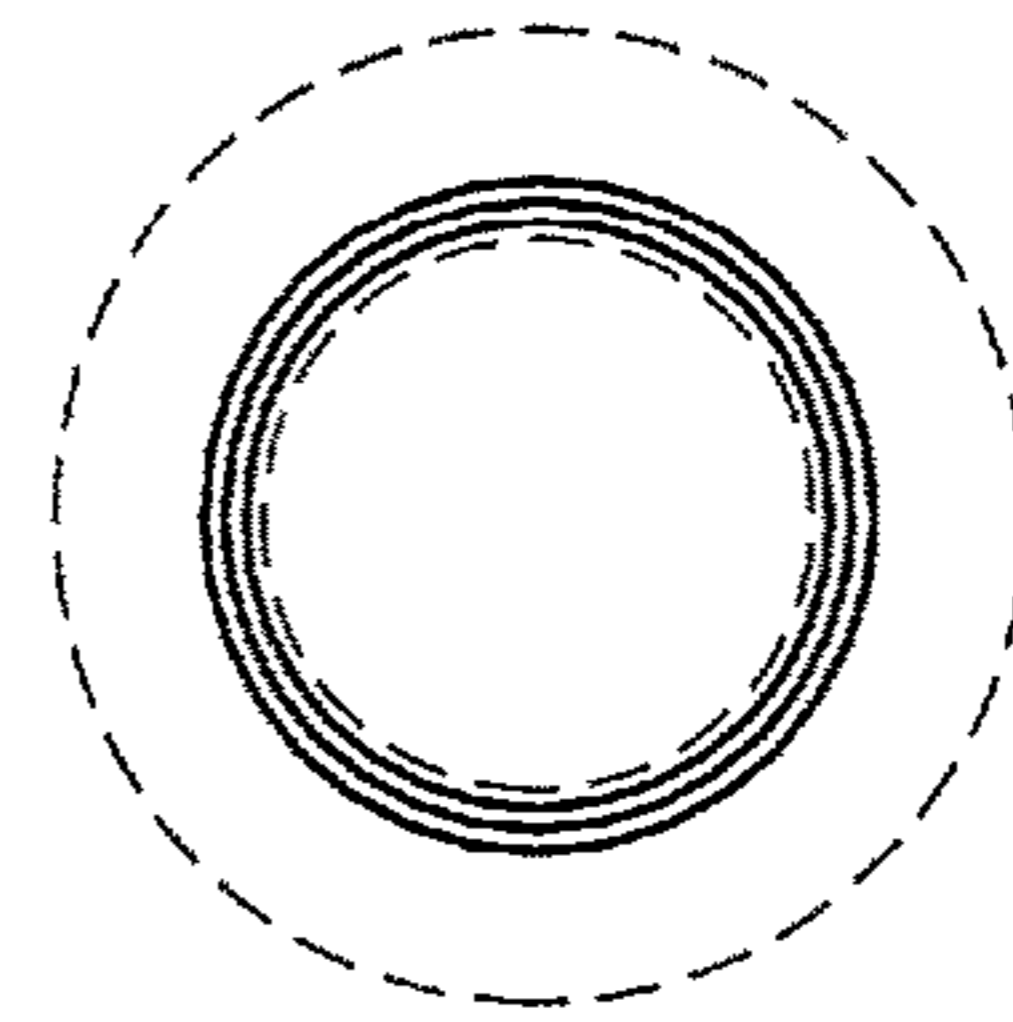

FIG. 7

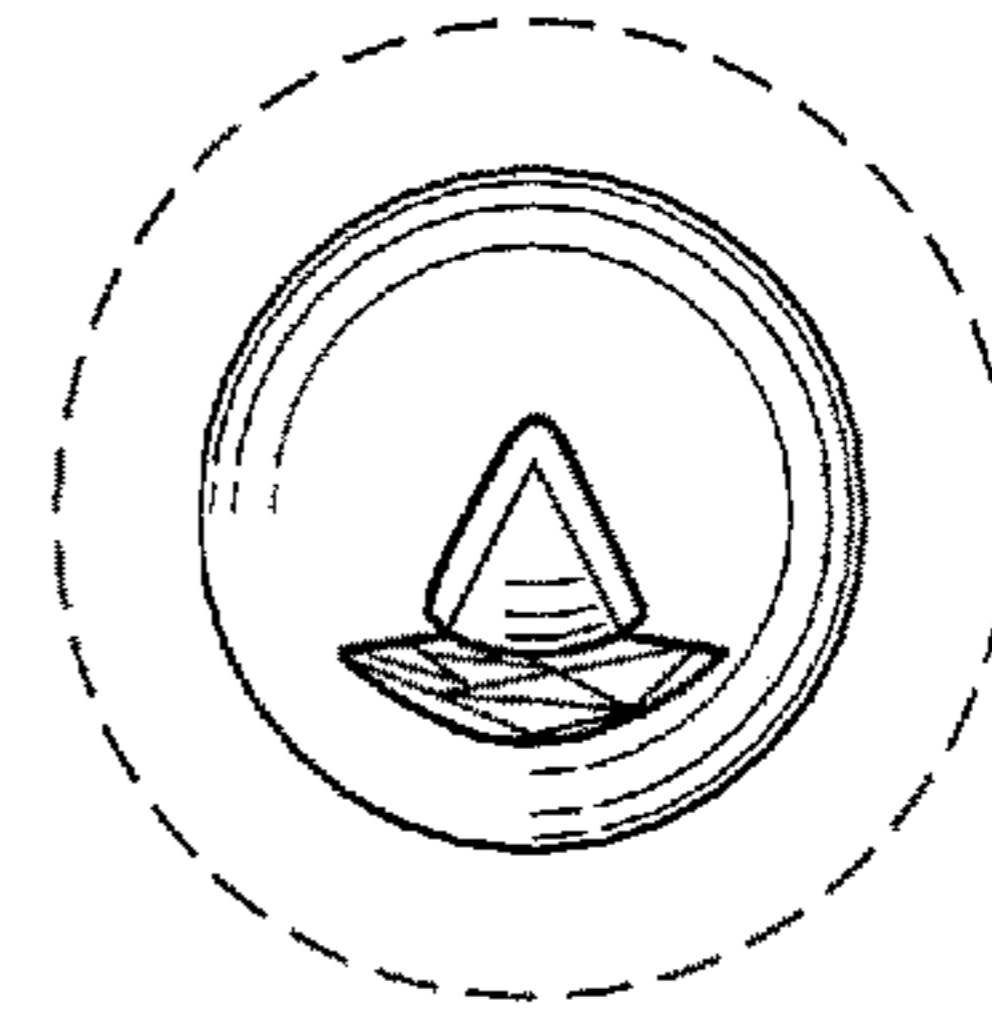

FIG. 8

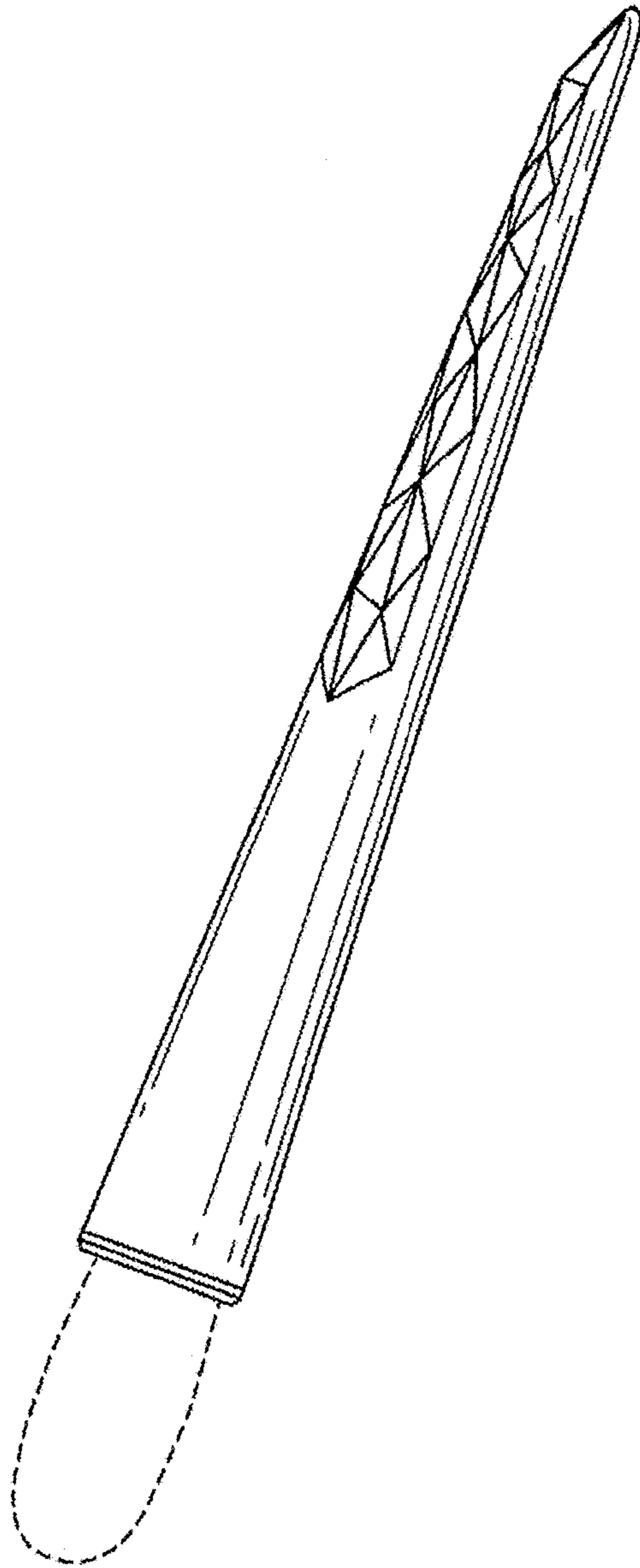

FIG. 9

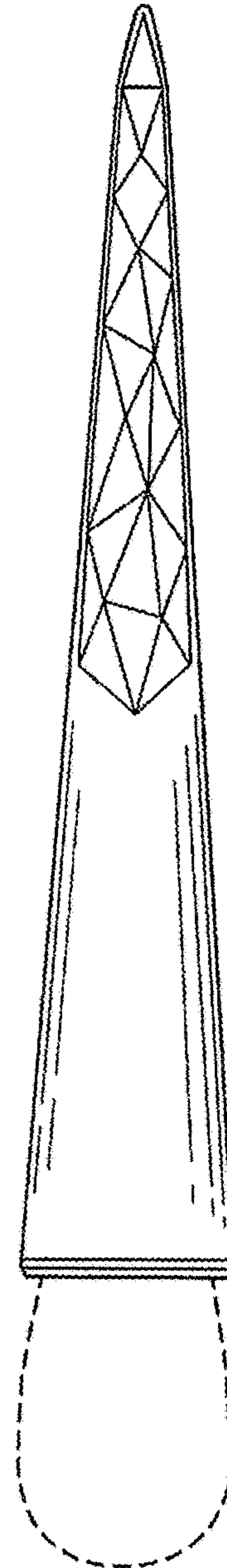

FIG. 10

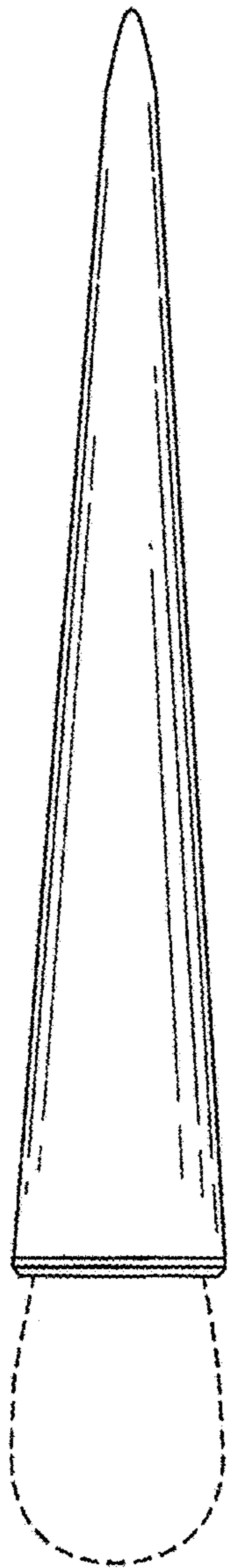

FIG. 11

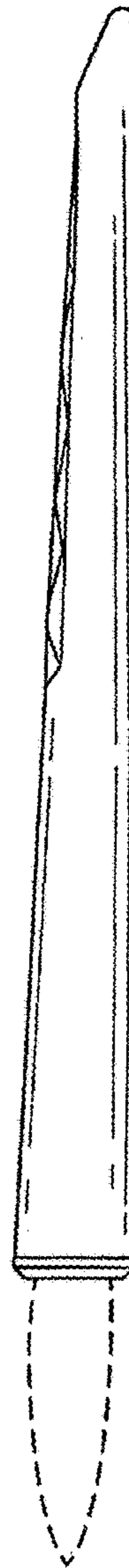

FIG. 12

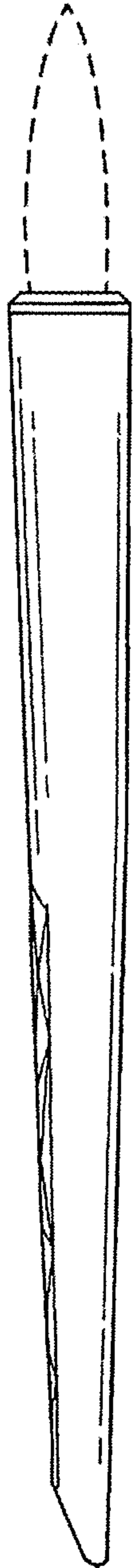

FIG. 13

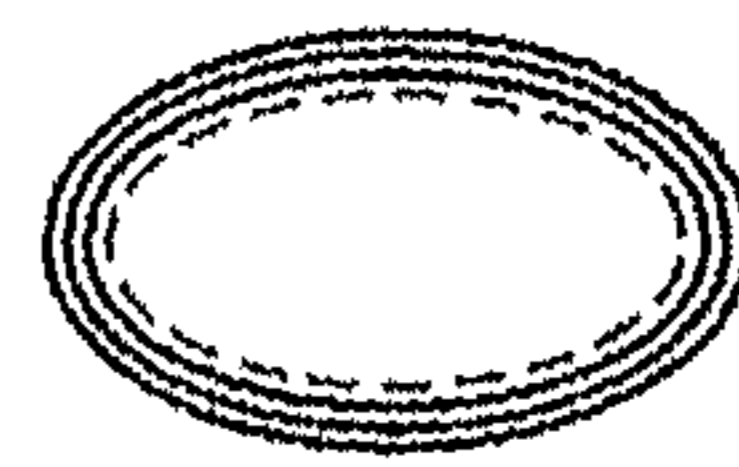
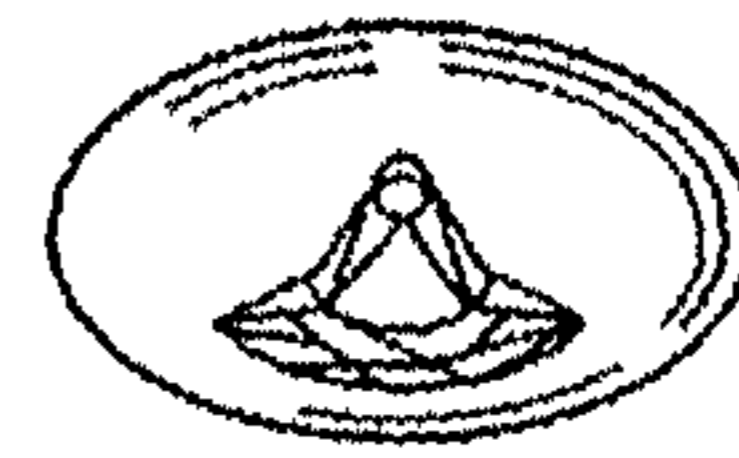

FIG. 14



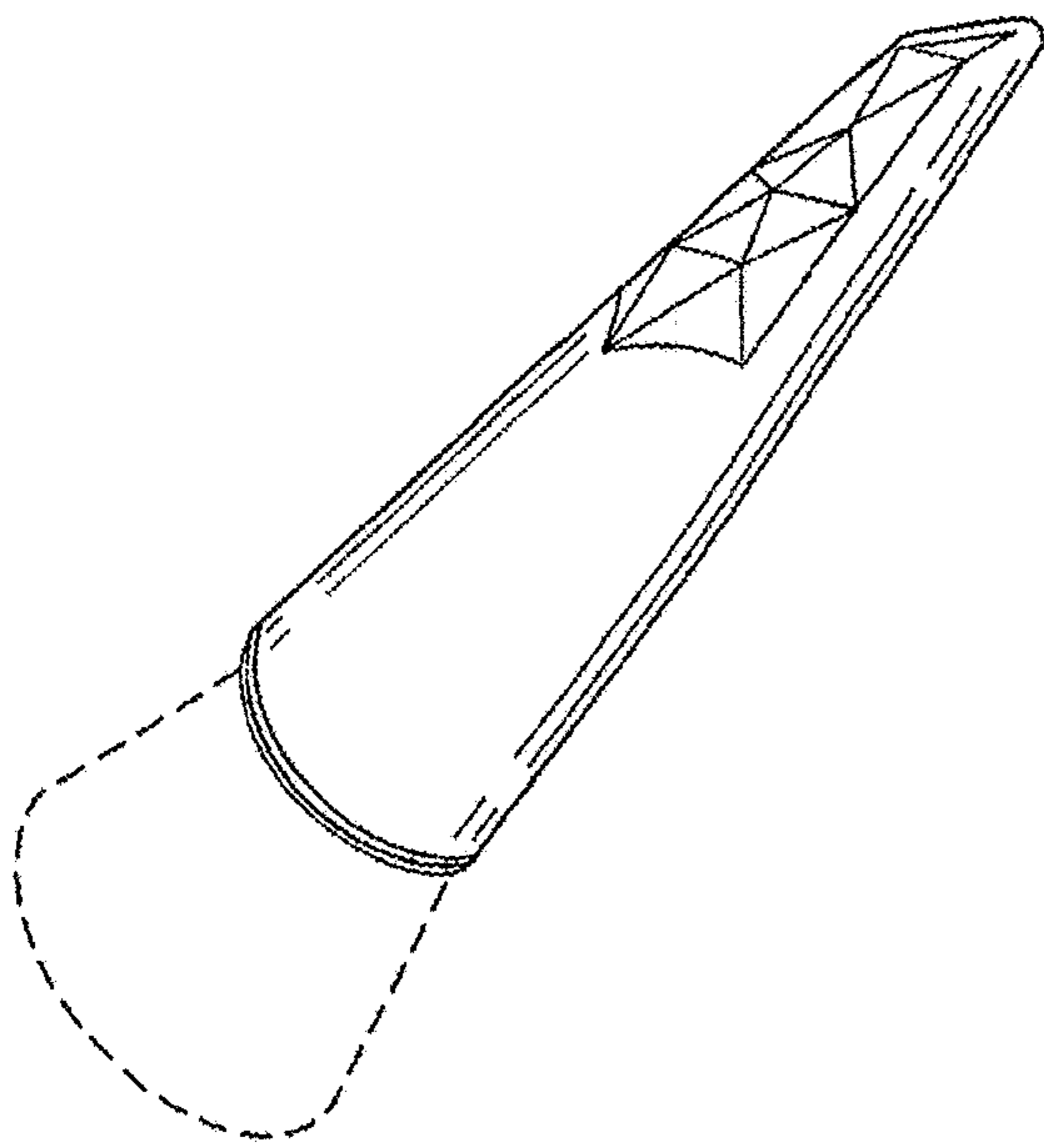

FIG. 15

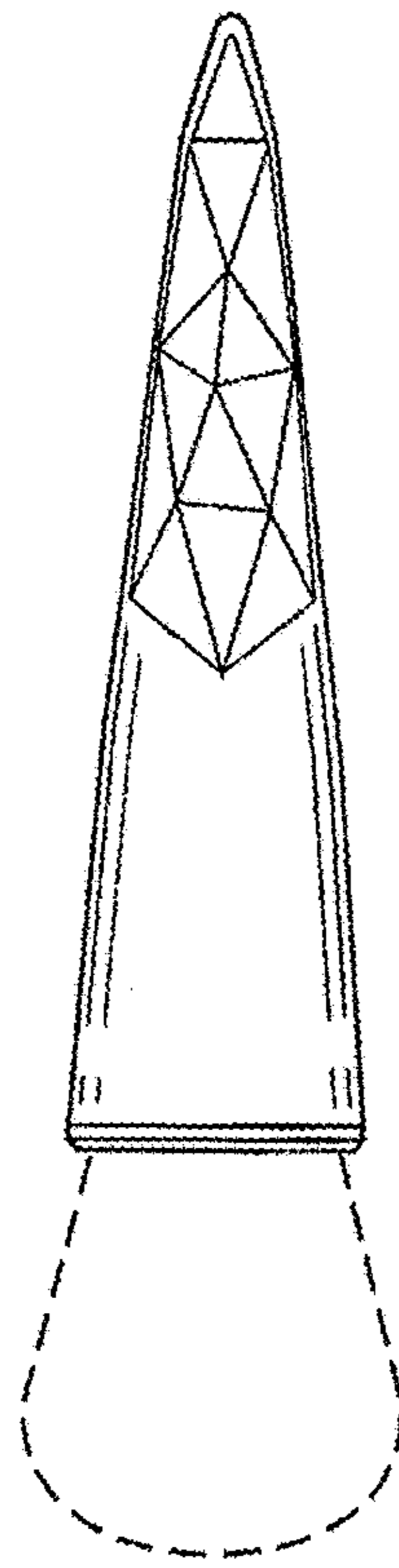

FIG. 16

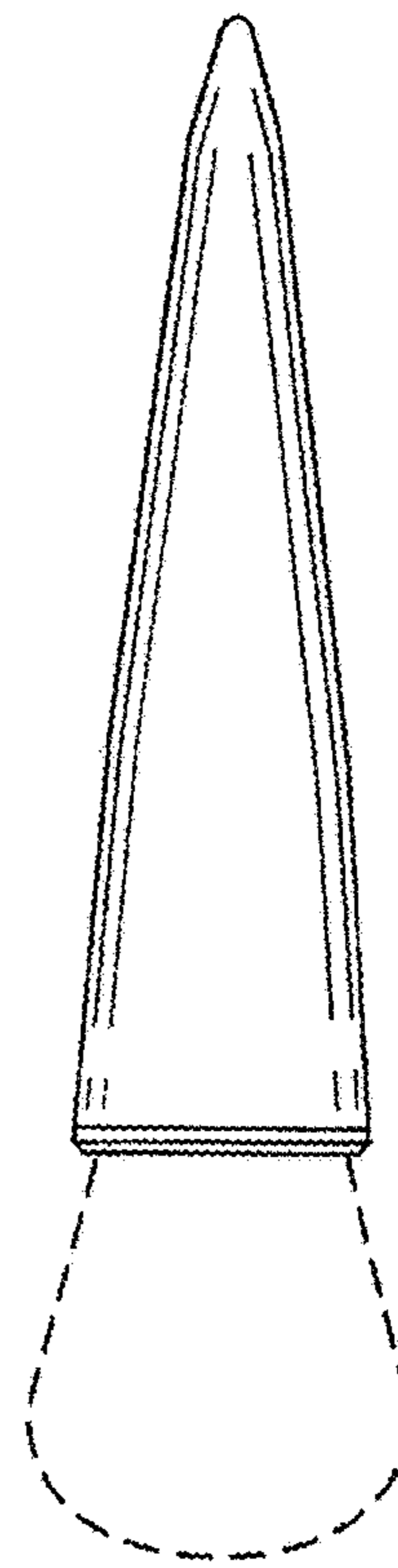

FIG. 17

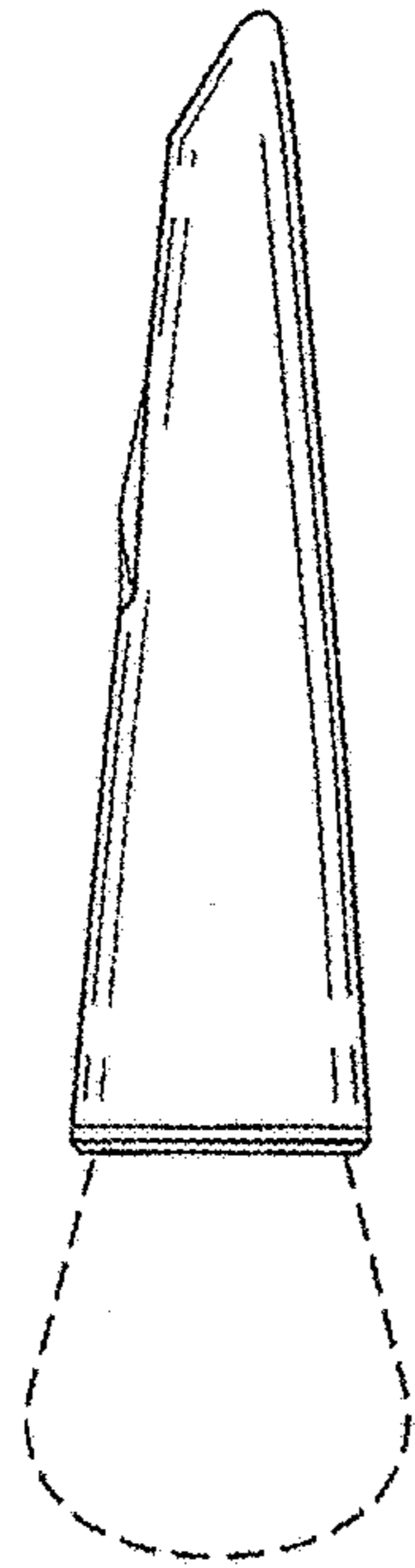

FIG. 18

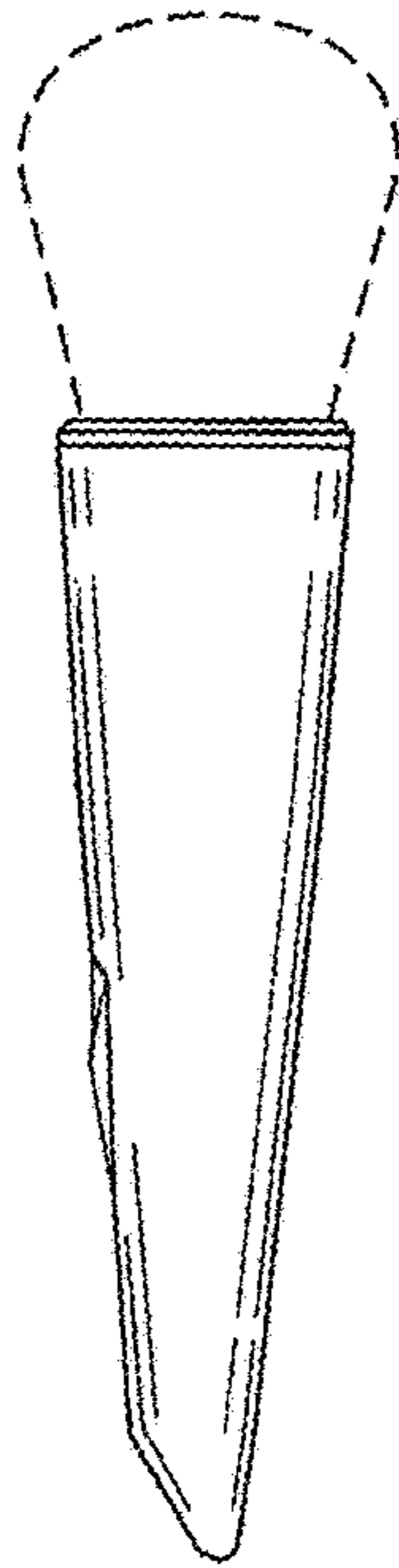

FIG. 19

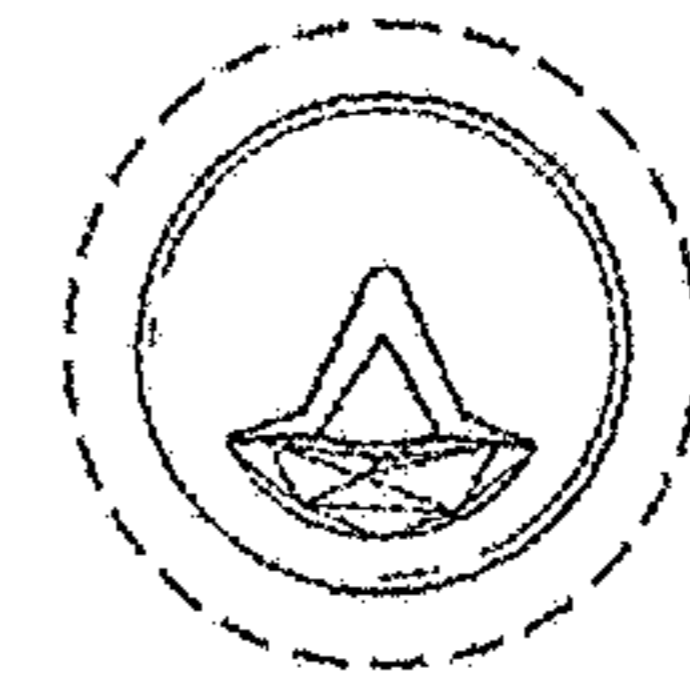

FIG. 21

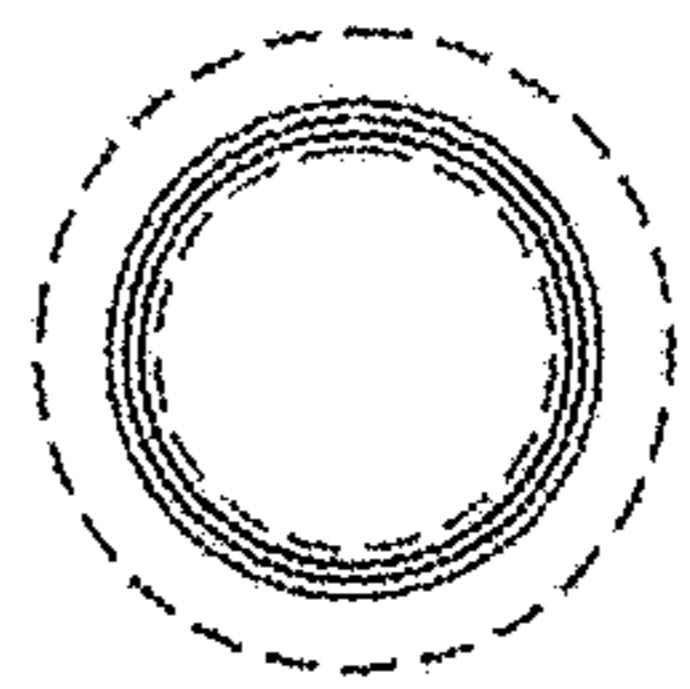

FIG. 20