



US00D782727S

(12) **United States Design Patent** (10) **Patent No.:** **US D782,727 S**  
**Weiss et al.** (45) **Date of Patent:** **\*\* Mar. 28, 2017**

(54) **LAMP**

(71) Applicants: **Blair Weiss**, Peterborough, NH (US);  
**Jason Lessard**, Bow, NH (US);  
**Richard Holland**, Stoddard, NH (US);  
**Craig Landcastle**, Bow, NH (US)

(72) Inventors: **Blair Weiss**, Peterborough, NH (US);  
**Jason Lessard**, Bow, NH (US);  
**Richard Holland**, Stoddard, NH (US);  
**Craig Landcastle**, Bow, NH (US)

(73) Assignee: **OSRAM SYLVANIA Inc.**, Wilmington, MA (US)

(\*\*) Term: **15 Years**

(21) Appl. No.: **29/579,993**

(22) Filed: **Oct. 5, 2016**

**Related U.S. Application Data**

(62) Division of application No. 29/525,601, filed on Apr. 30, 2015, now Pat. No. Des. 771,860.

(51) **LOC (10) Cl.** ..... **26-03**

(52) **U.S. Cl.**  
USPC ..... **D26/110; D26/124**

(58) **Field of Classification Search**  
USPC .. D26/24, 85, 89, 26, 37, 93, 104, 106, 124, D26/110  
CPC ..... F21S 8/03; F21S 8/033; F21S 8/04; F21V 3/04; F21V 3/0418; F21V 3/0427; F21V 3/0436; F21V 3/0445; F21V 21/02; F21V 21/03; F21V 29/506; F21V 3/049; F21V 5/045; F21V 7/04; F21V 11/06; B01J 23/8875

See application file for complete search history.

(56) **References Cited**

**U.S. PATENT DOCUMENTS**

4,334,116	A *	6/1982	Velenyi .....	B01J 23/8875
				585/440
D482,484	S *	11/2003	Benghozi .....	D26/85
D490,183	S *	5/2004	Benensohn .....	D26/89
D493,246	S *	7/2004	Benensohn .....	D26/89
D544,618	S *	6/2007	Coushaine .....	D26/37
D556,938	S *	12/2007	Russello .....	D26/89
D574,095	S *	7/2008	Hill .....	D26/26
D607,600	S *	1/2010	Keith .....	D26/85
D633,644	S *	3/2011	Sprengers .....	D26/89
D647,227	S *	10/2011	Kaule .....	D26/24
8,491,148	B2	7/2013	Coushaine et al.	
D694,463	S *	11/2013	Sieczkowski .....	D26/124

(Continued)

**OTHER PUBLICATIONS**

Sylvania "Dot-It Checker Light" LED utility light marketed by Osram Sylvania Inc., on sale prior to present application filing date at <https://store.kortendickhardware.com> (1 page, in color).

*Primary Examiner* — Brian N Vinson

(74) *Attorney, Agent, or Firm* — Edward S. Podszus

(57) **CLAIM**

The ornamental design for a lamp, as shown and described.

**DESCRIPTION**

FIG. 1 is a perspective view of the design for a lamp as seen from the front, top;  
FIG. 2 is a front elevational view thereof;  
FIG. 3 is a top view thereof;  
FIG. 4 is a left side elevational view thereof;  
FIG. 5 is a right side elevational view thereof; and,  
FIG. 6 is a bottom view thereof.  
The broken line disclosure is for environmental purposes only and does not form a part of the claimed design.

**1 Claim, 3 Drawing Sheets**

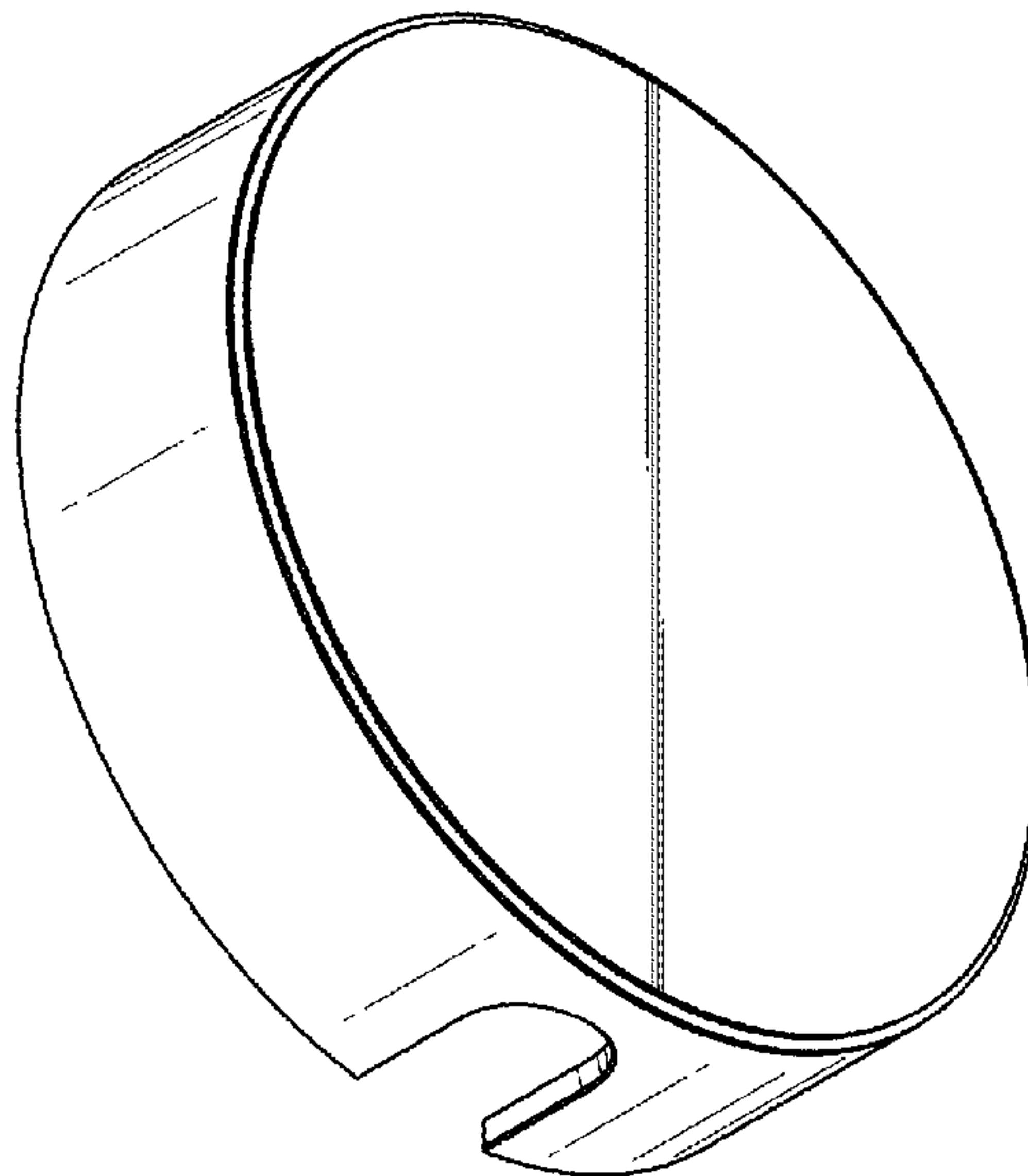

(56)

**References Cited**

U.S. PATENT DOCUMENTS

D759,877 S \* 6/2016 Hewitt ..... D26/89

\* cited by examiner

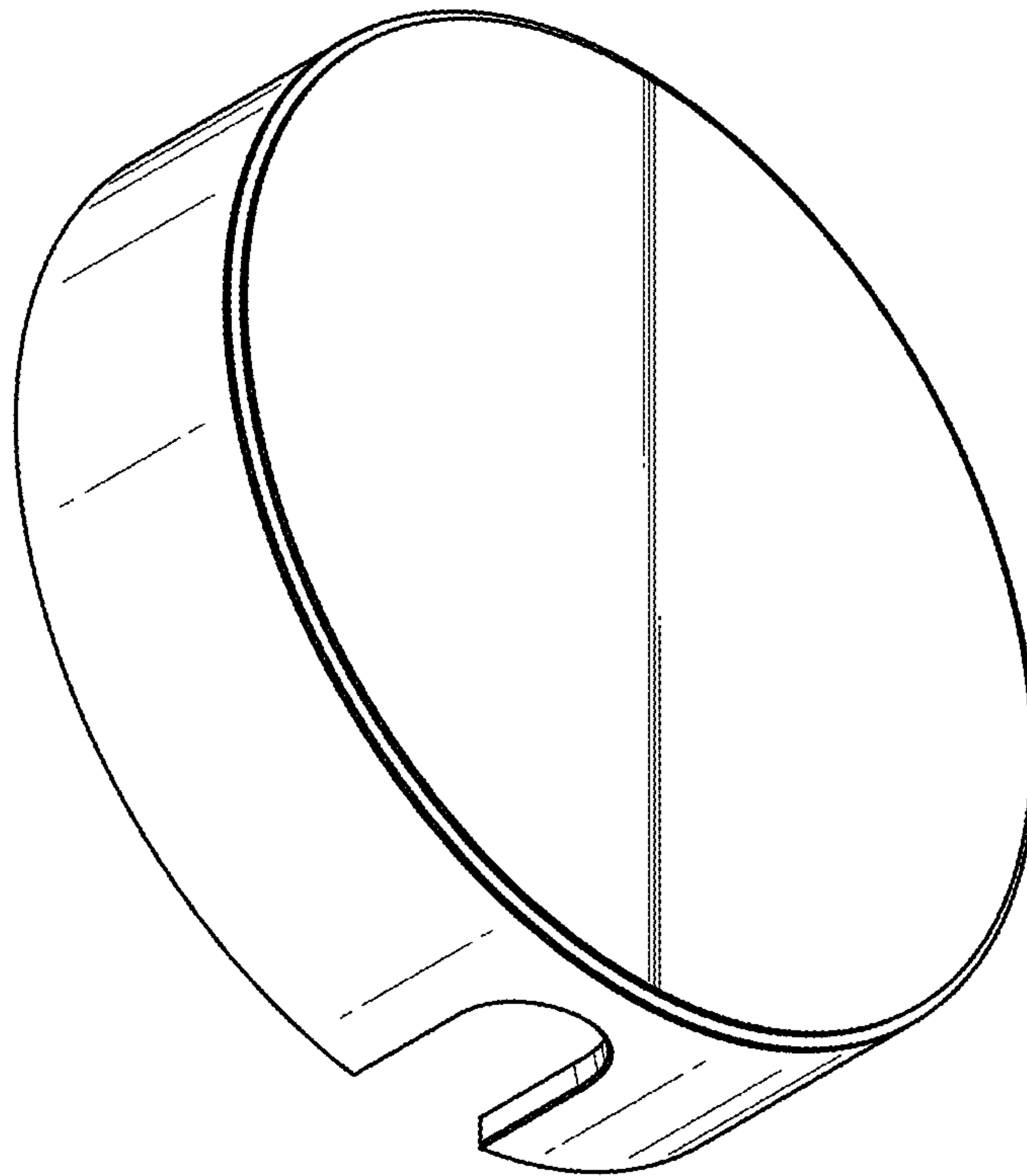

FIG. 1

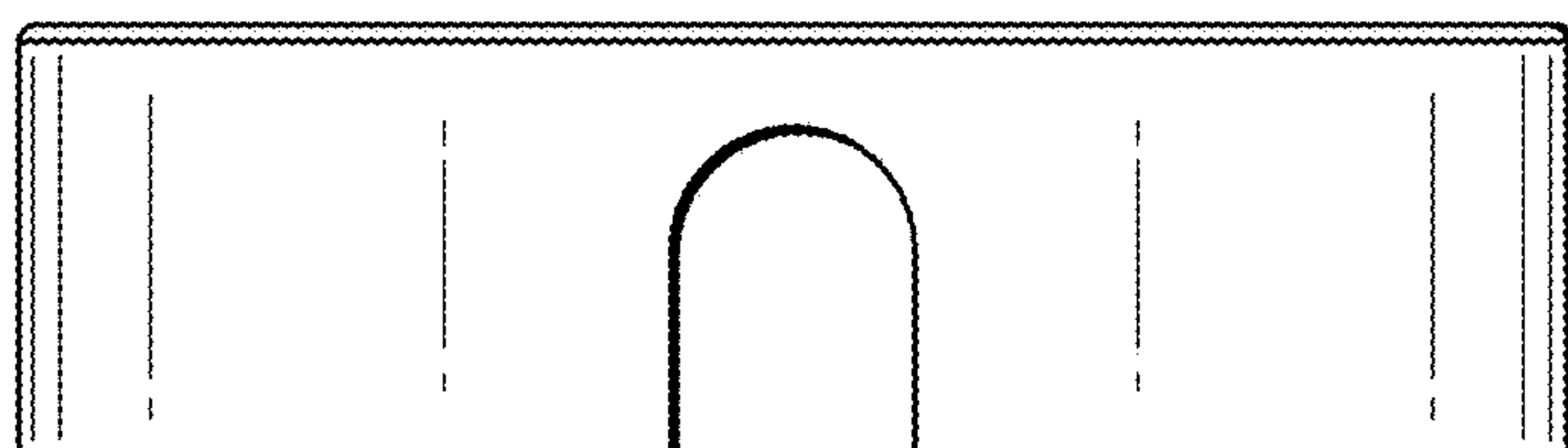

FIG. 2

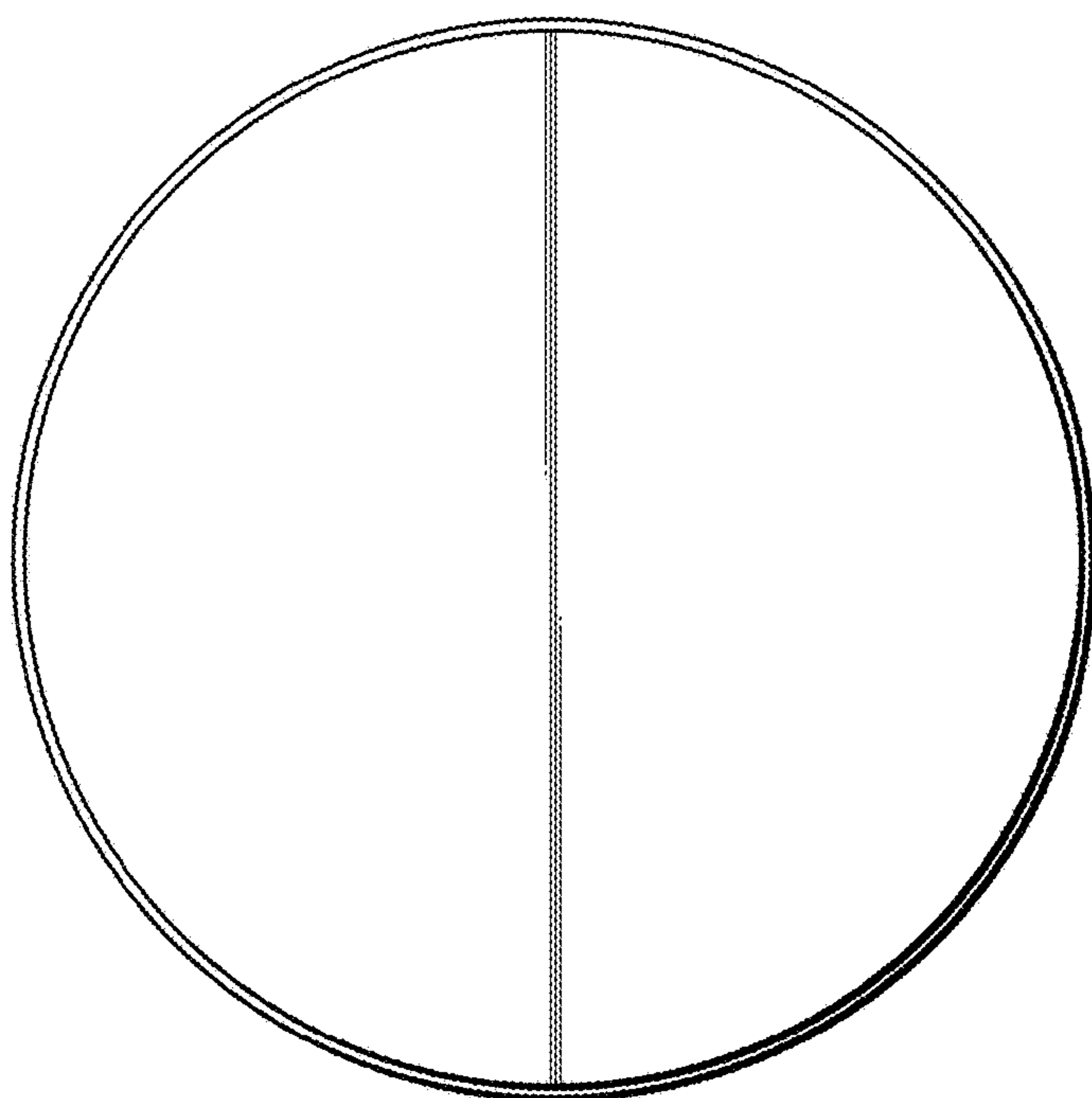

FIG. 3

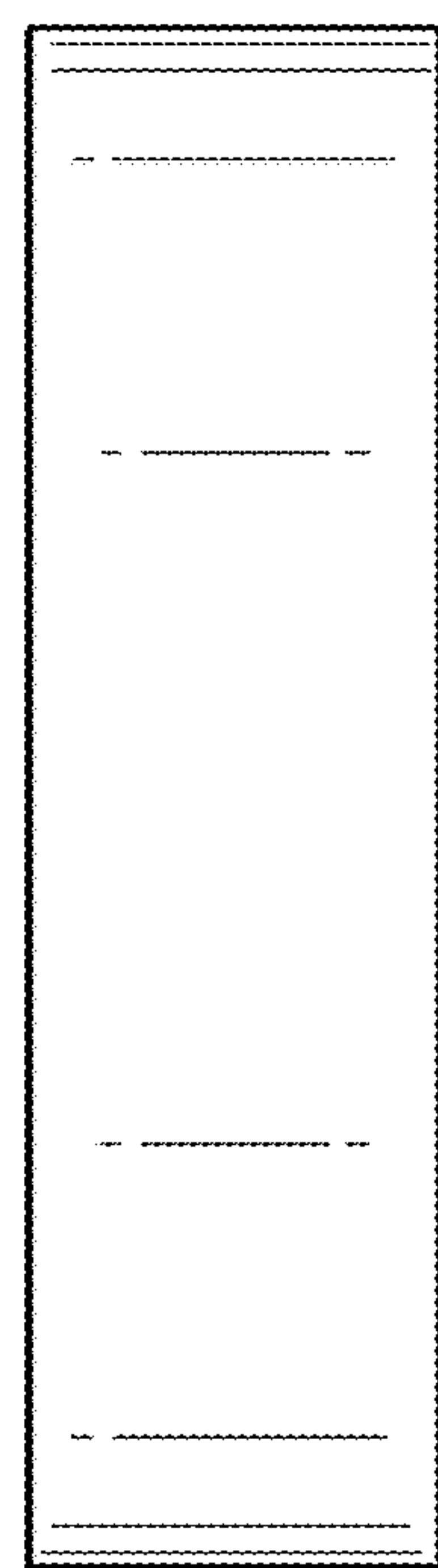

FIG. 4

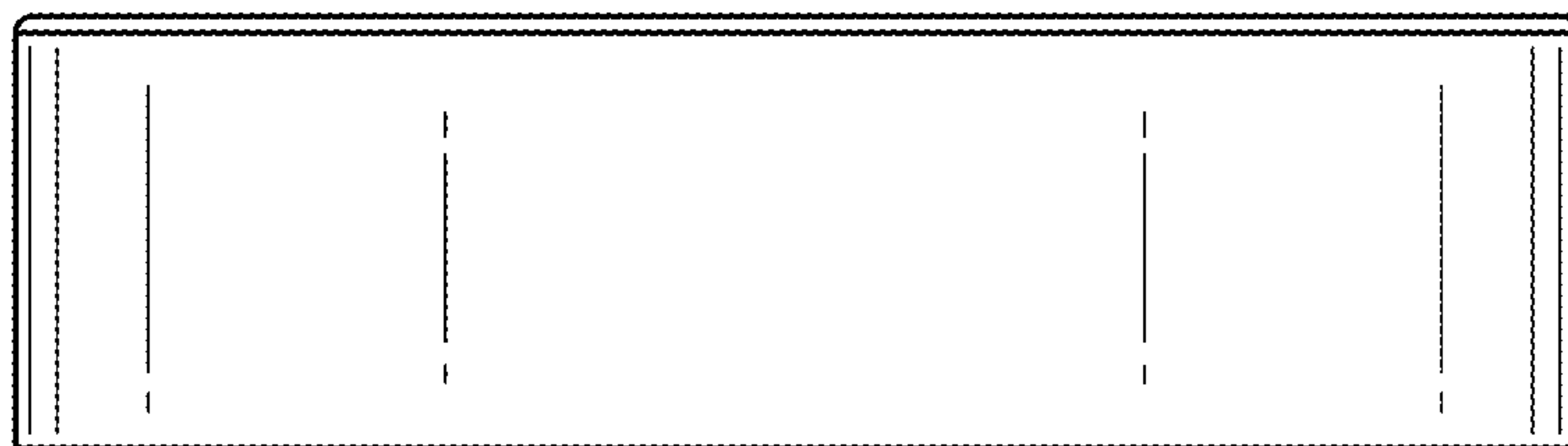

FIG. 5

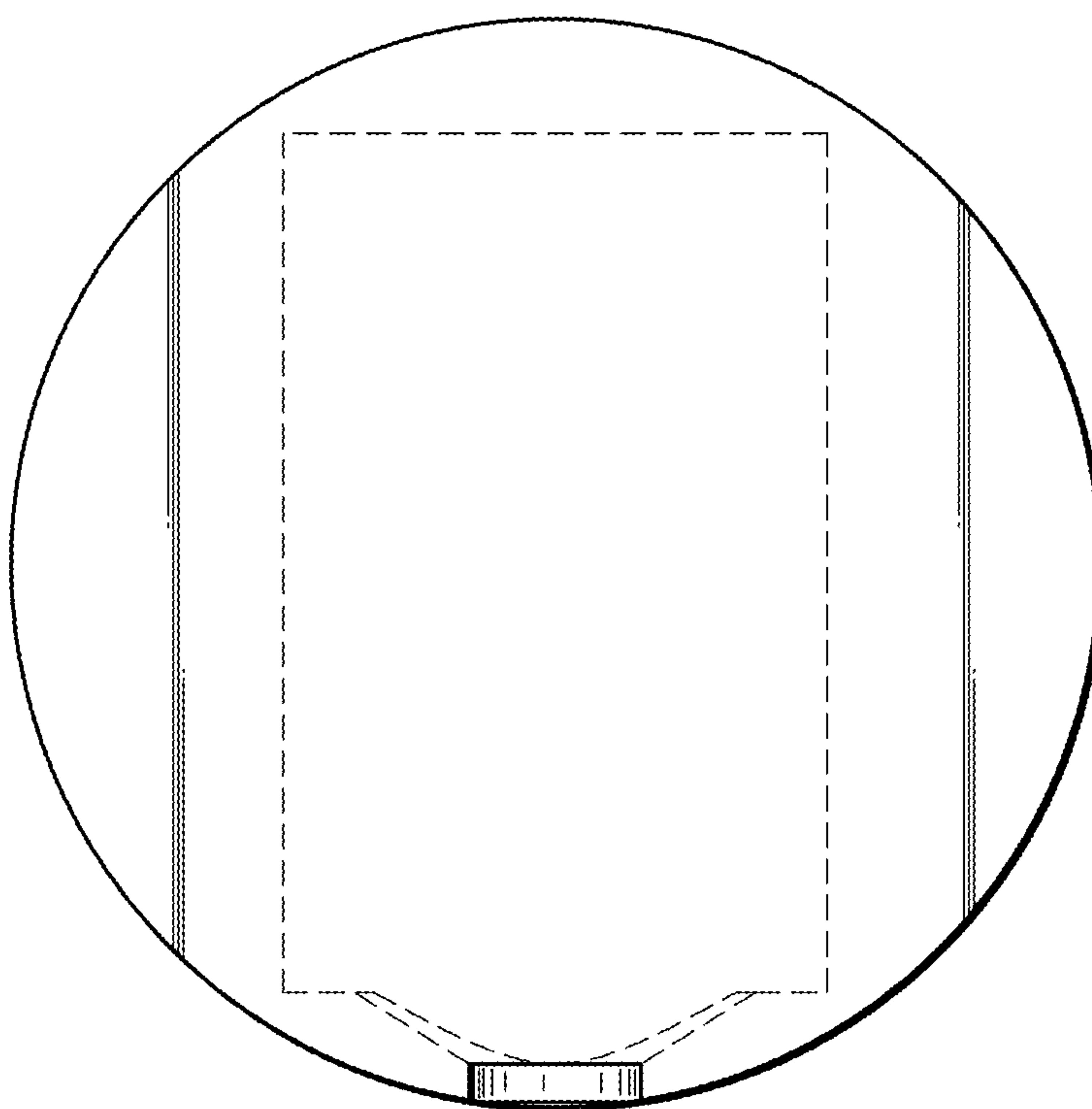

FIG. 6