



US00D782713S

(12) **United States Design Patent** (10) **Patent No.:** **US D782,713 S**  
**Munakata et al.** (45) **Date of Patent:** **\*\* Mar. 28, 2017**

(54) **REAR COMBINATION LAMP FOR AUTOMOBILE**

(71) Applicant: **Nissan Motor Co., Ltd.**, Yokohama, Kanagawa (JP)

(72) Inventors: **Kenichi Munakata**, Tokyo (JP); **Jaesang Lee**, Tokyo (JP)

(73) Assignee: **Nissan Motor Co., Ltd.**, Yokohama (JP)

(\*\*) Term: **15 Years**

(21) Appl. No.: **29/534,367**

(22) Filed: **Jul. 28, 2015**

(30) **Foreign Application Priority Data**

Jan. 30, 2015 (JP) ..... 2015-001765

(51) **LOC (10) Cl.** ..... **26-07**

(52) **U.S. Cl.**  
USPC ..... **D26/28**

(58) **Field of Classification Search**  
USPC ..... D26/28-36; 362/459-468, 475-478, 362/485-487

(Continued)

(56) **References Cited**

**U.S. PATENT DOCUMENTS**

D670,842 S 11/2012 Fuchigami et al.  
D680,249 S 4/2013 Iwai et al.

(Continued)

**FOREIGN PATENT DOCUMENTS**

JP D1349851 S 2/2009  
JP D1359797 S 5/2009

(Continued)

*Primary Examiner* — Angela J Lee

(74) *Attorney, Agent, or Firm* — Global IP Counselors, LLP

(57) **CLAIM**

The ornamental design for a rear combination lamp for automobile, as shown and described.

**DESCRIPTION**

FIG. 1 is a front elevational view of a rear combination lamp for automobile in accordance with a first embodiment of our new design;

FIG. 2 is a rear elevational view of the rear combination lamp in accordance with the first embodiment of our new design of FIG. 1;

FIG. 3 is a top plan view of the rear combination lamp in accordance with the first embodiment of our new design of FIGS. 1 and 2;

FIG. 4 is a bottom plan view of the rear combination lamp in accordance with the first embodiment of our new design of FIGS. 1 to 3;

FIG. 5 is a left side elevational view of the rear combination lamp in accordance with the first embodiment of our new design of FIGS. 1 to 4;

FIG. 6 is a right side elevational view of the rear combination lamp in accordance with the first embodiment of our new design of FIGS. 1 to 5; and,

FIG. 7 is a front side perspective view of the rear combination lamp in accordance with the first embodiment of our new design of FIGS. 1 to 6.

The rear combination lamp is configured to be mounted to an automobile. The mounting structure and support structure of the rear combination lamp, shown in broken lines in FIGS. 2 to 7, form no part of the claimed design since the mounting structure and support structure are hidden when the rear combination lamp is mounted to the automobile.

In addition, the appearance of the rear side structures of the rear combination lamp as shown in broken lines in FIGS. 2 to 7 is for purpose of illustrating the boundaries of the exterior surface of the rear combination lamp, and forms no part of the claimed design.

A second embodiment of our new design is identical to the first embodiment. The second embodiment of our new design includes the mirror image of the rear combination lamp shown in FIGS. 1 to 7.

**1 Claim, 7 Drawing Sheets**

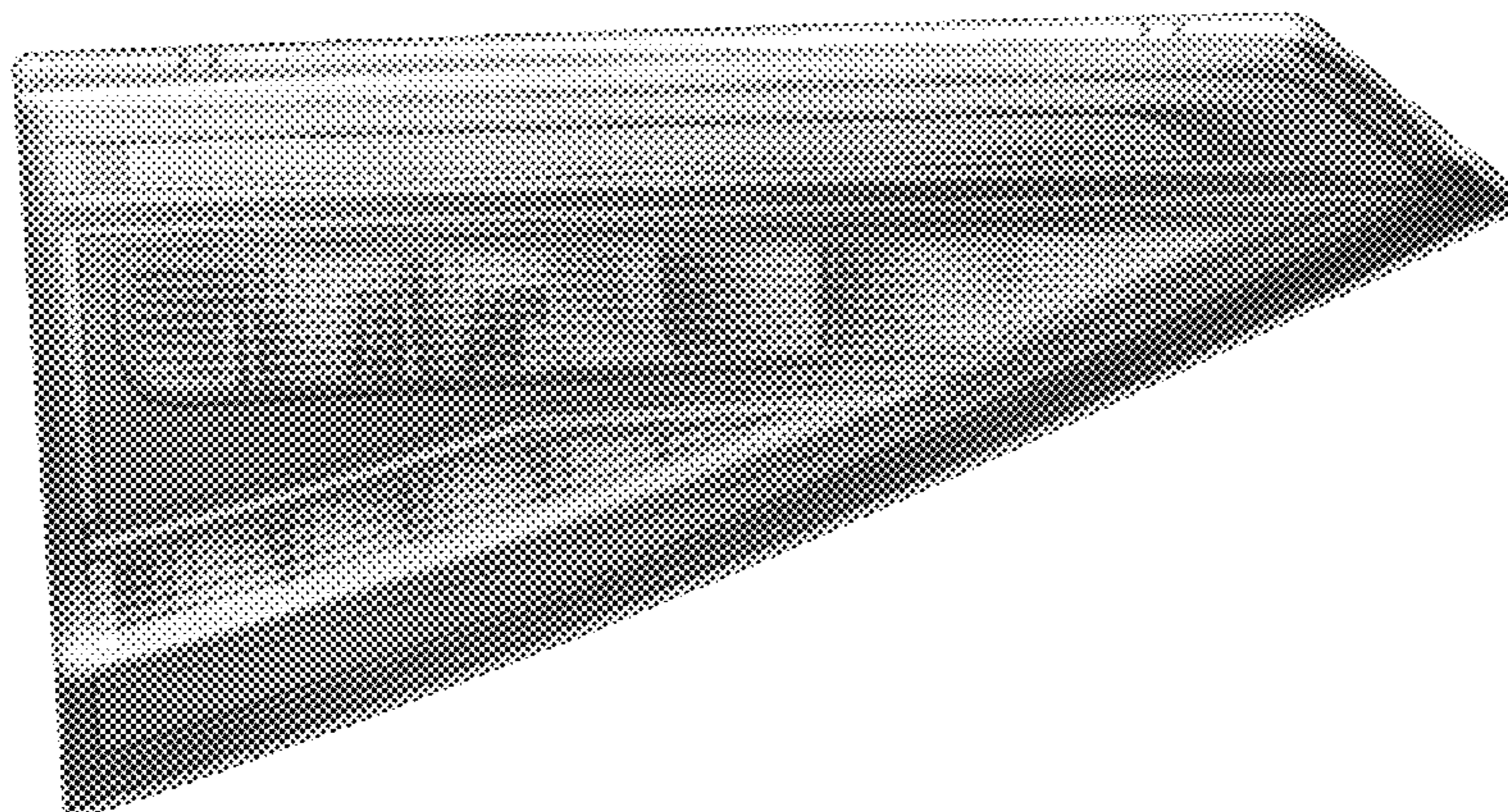

# US D782,713 S

Page 2

(58) **Field of Classification Search**

CPC ..... F21S 48/00; F21S 48/10; F21S 48/115;  
F21S 48/225; F21S 48/1233; F21S  
48/1266; F21S 48/1388; F21S 48/2268;  
F21V 21/04

See application file for complete search history.

D757,967 S \* 5/2016 Kim ..... D26/28  
D760,411 S \* 6/2016 Andersson Murkett ..... D26/28  
D760,412 S \* 6/2016 Andersson Murkett ..... D26/28  
D761,463 S \* 7/2016 Lai ..... D26/28  
D761,978 S \* 7/2016 Lai ..... D26/28

FOREIGN PATENT DOCUMENTS

(56)

**References Cited**

U.S. PATENT DOCUMENTS

D684,715 S 6/2013 Cogswell  
D690,447 S 9/2013 Endo et al.  
D701,983 S \* 4/2014 Kong ..... D26/28  
D710,524 S 8/2014 Hirabayashi  
D735,920 S \* 8/2015 Honda ..... D26/28  
D745,717 S \* 12/2015 Wu ..... D26/28  
D748,305 S \* 1/2016 Miyazawa ..... D26/28  
D749,251 S \* 2/2016 Nakahara ..... D26/28  
D752,780 S \* 3/2016 Hall ..... D26/28  
D752,783 S \* 3/2016 Whang ..... D26/28  
D755,420 S \* 5/2016 Ko ..... D26/28

JP D1386705 S 5/2010  
JP D1388786 S 5/2010  
JP D1403148 S 12/2010  
JP D1417521 S 6/2011  
JP D1403173 S 12/2011  
JP D1419130 S 7/2012  
JP D1485582 S 12/2013  
JP D1485753 S 12/2013  
JP D1488375 S 1/2014  
JP D1501245 S 6/2014  
JP D1501952 S 7/2014  
JP D1480240 S 9/2014  
JP D1491259 S 2/2015  
JP D1501254 S 6/2015

\* cited by examiner

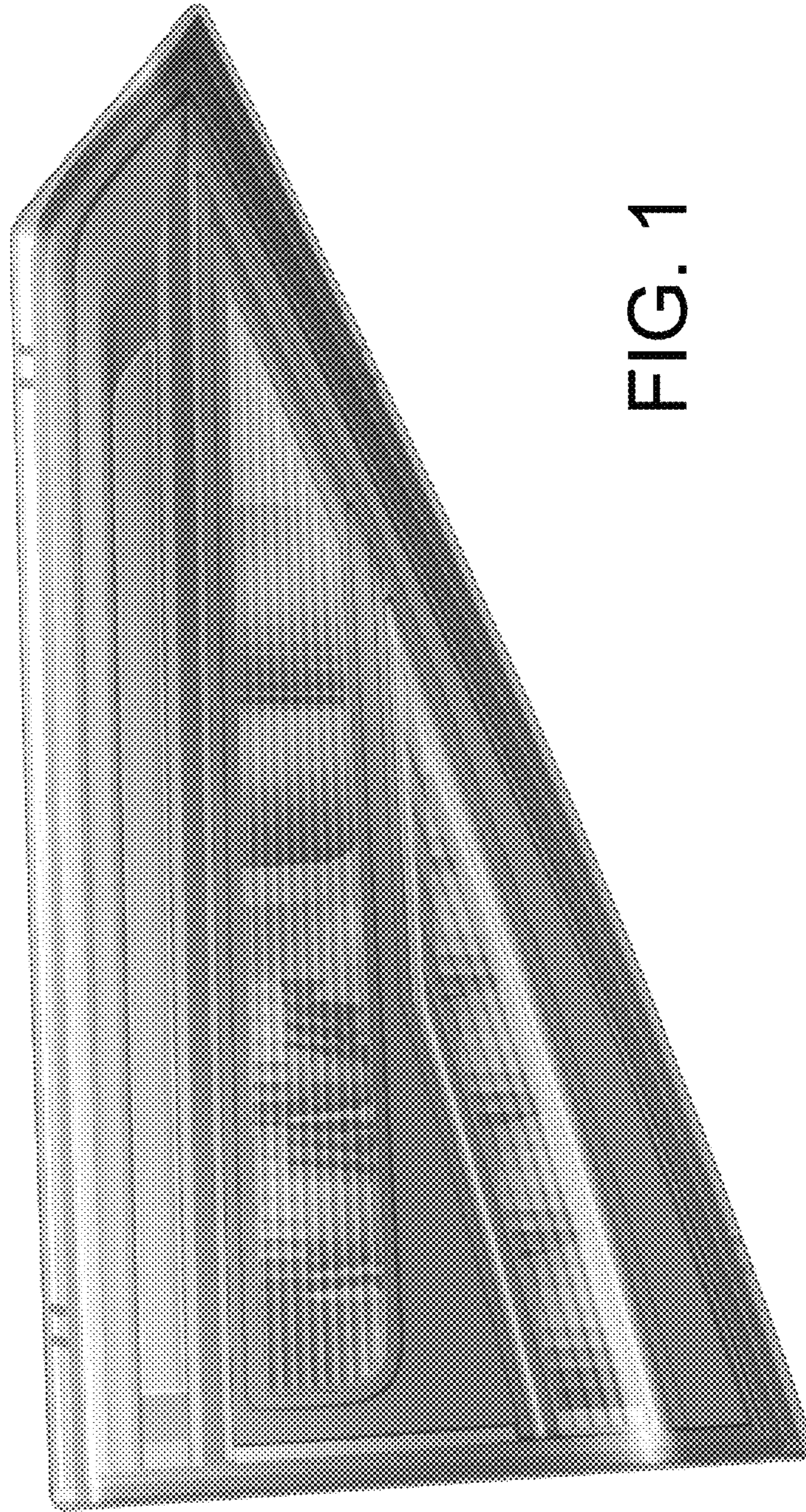

FIG. 1

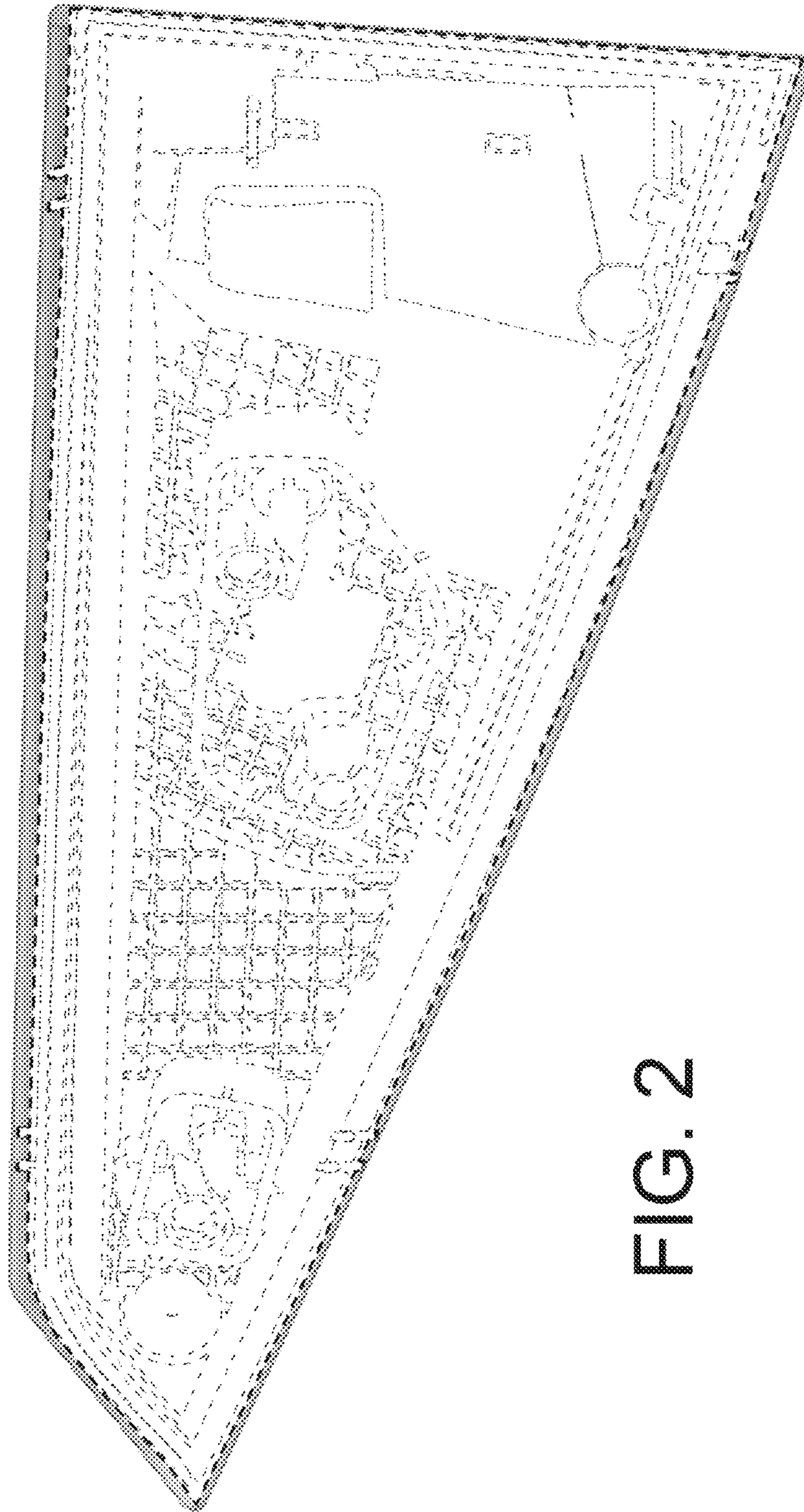
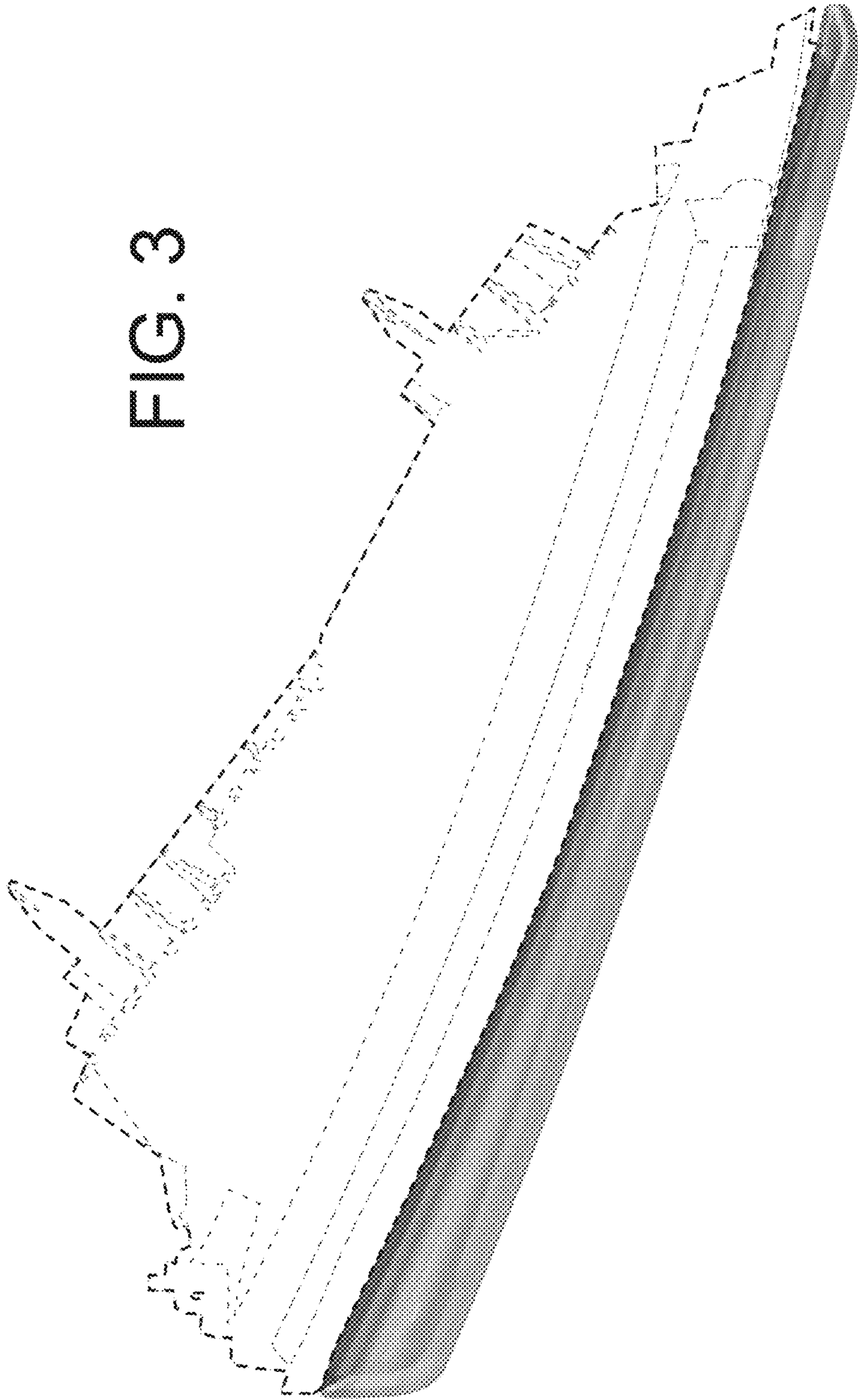

FIG. 2

FIG. 3



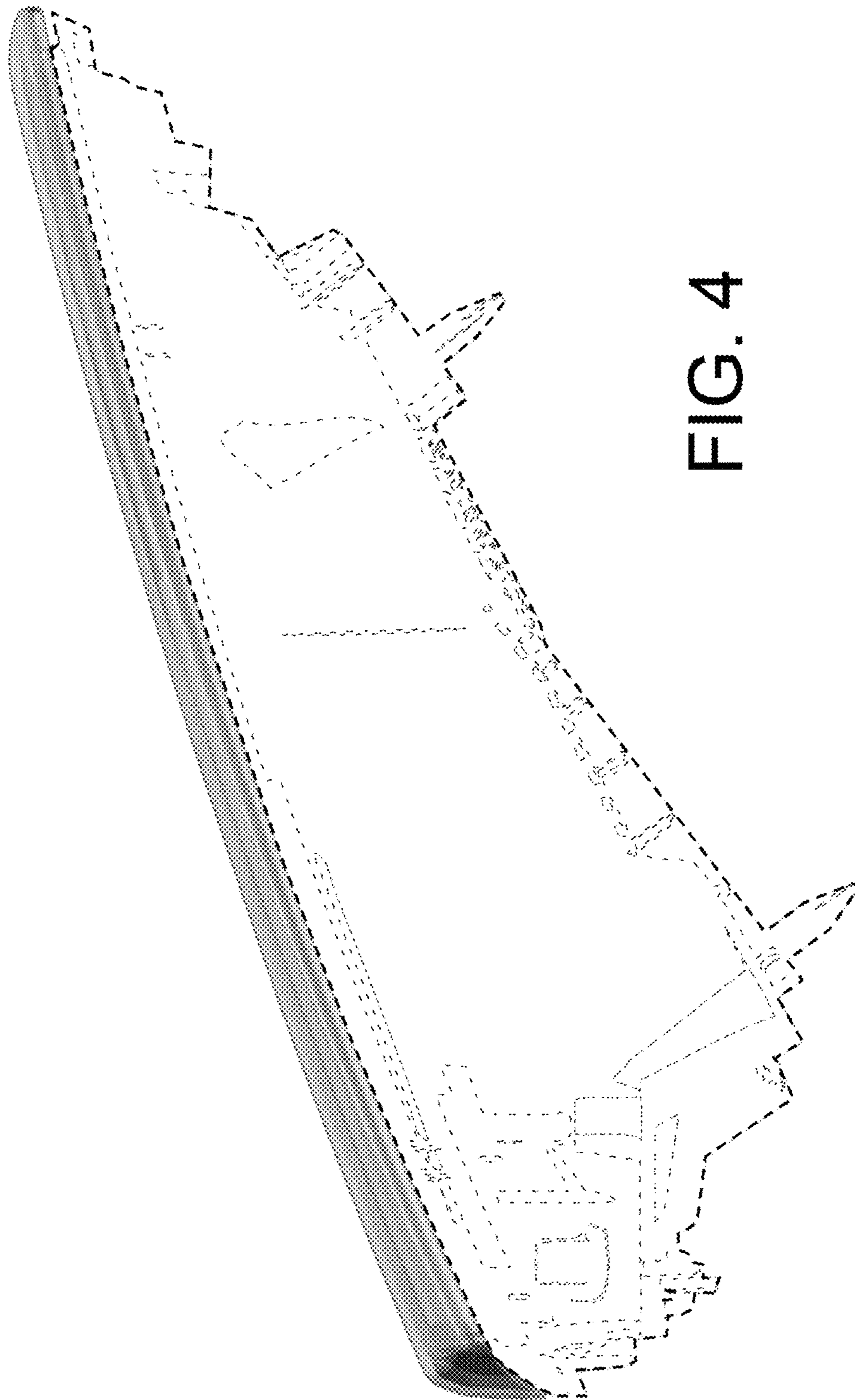

FIG. 4

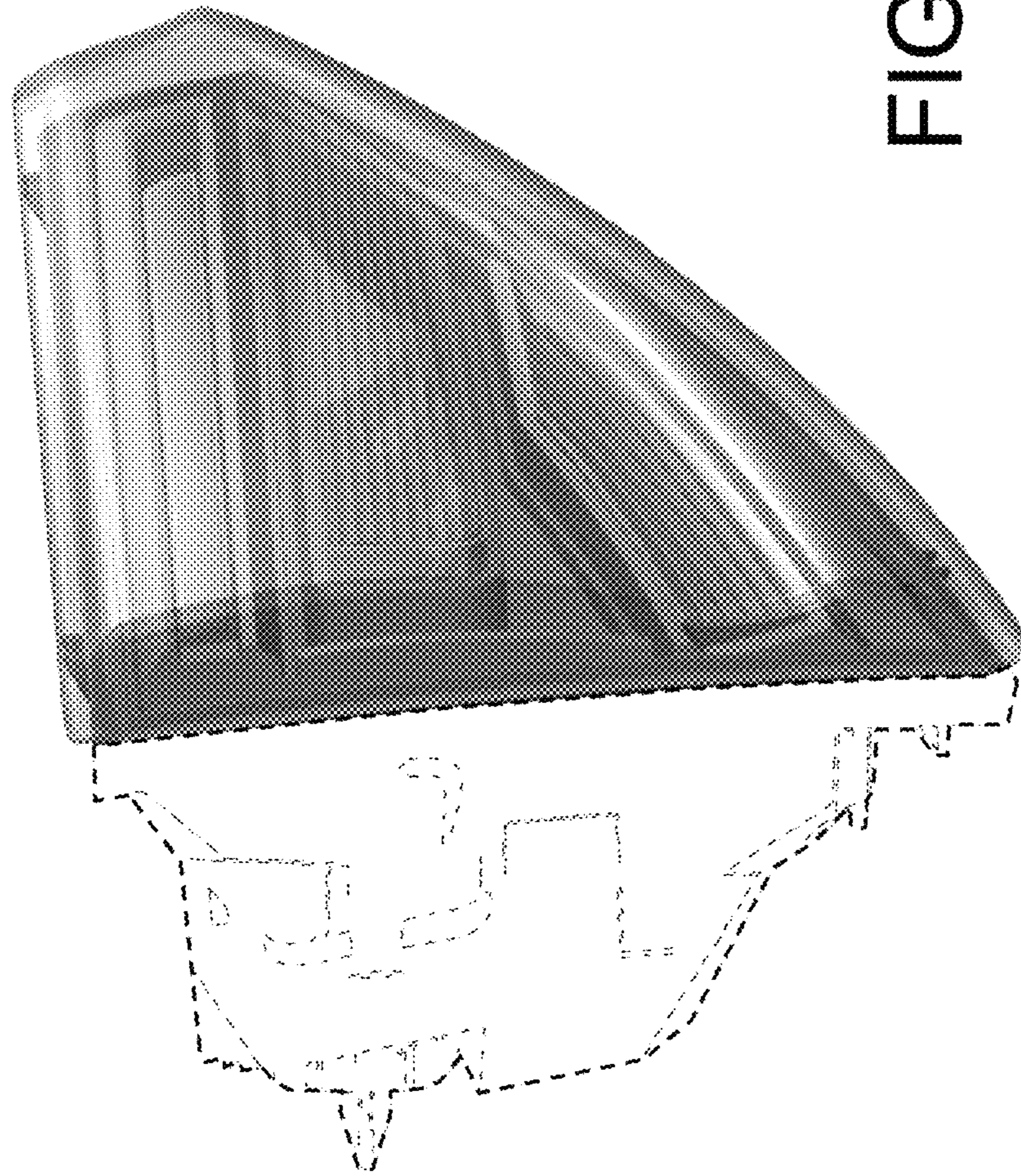

FIG. 5

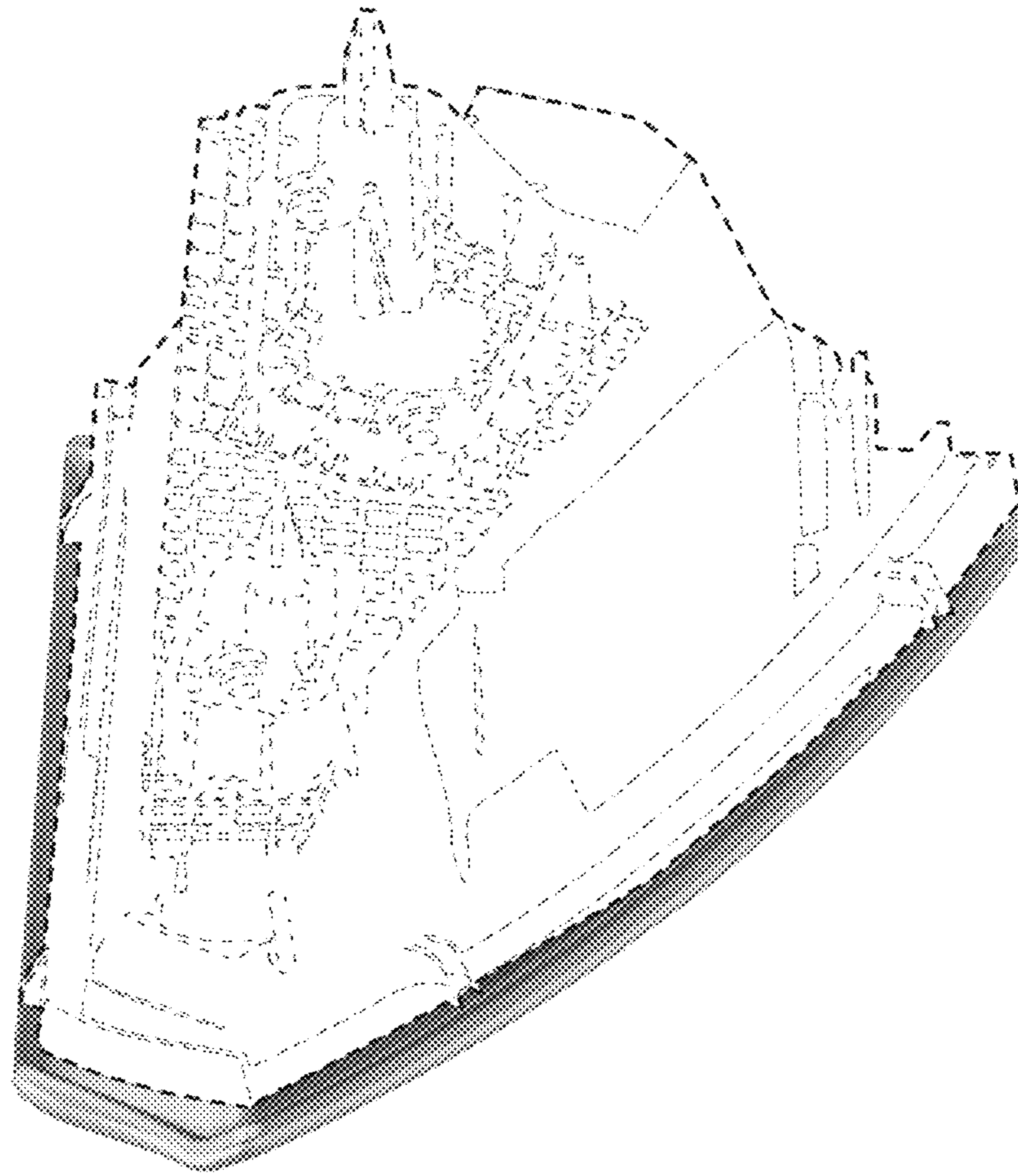

FIG. 6



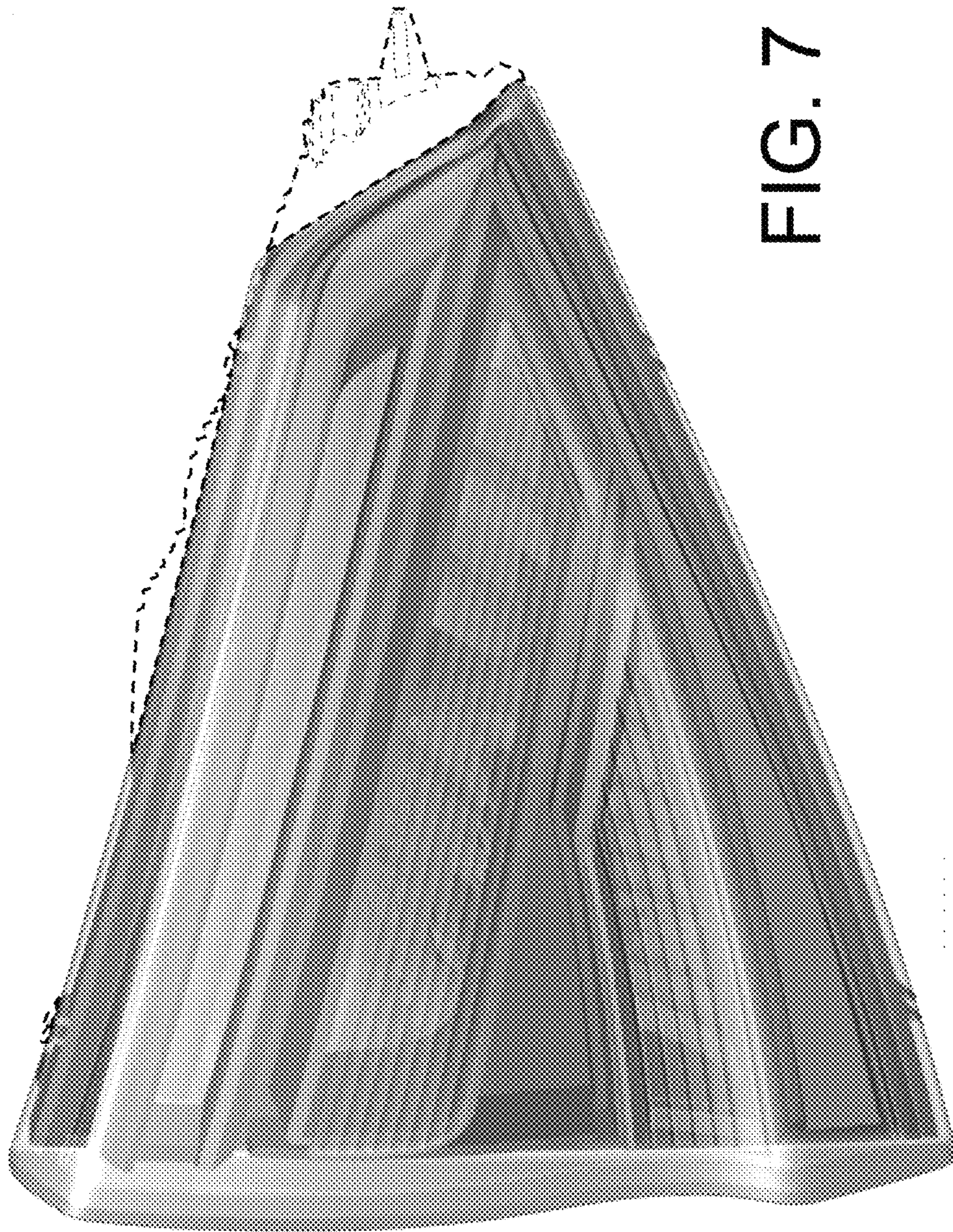

FIG. 7