



US00D782712S

(12) **United States Design Patent**
Munakata et al.

(10) **Patent No.:** **US D782,712 S**
(45) **Date of Patent:** **** Mar. 28, 2017**

(54) **REAR COMBINATION LAMP FOR
AUTOMOBILE**

(71) Applicant: **Nissan Motor Co., Ltd.**, Yokohama,
Kanagawa (JP)

(72) Inventors: **Kenichi Munakata**, Tokyo (JP);
Jaesang Lee, Tokyo (JP)

(73) Assignee: **Nissan Motor Co., Ltd.**, Yokohama
(JP)

(**) Term: **15 Years**

(21) Appl. No.: **29/534,364**

(22) Filed: **Jul. 28, 2015**

(30) **Foreign Application Priority Data**

Jan. 30, 2015 (JP) 2015-001764

(51) **LOC (10) Cl.** **26-07**

(52) **U.S. Cl.**
USPC **D26/28**

(58) **Field of Classification Search**
USPC D26/28-36; 362/459-468, 475-478,
362/485-487

(Continued)

(56) **References Cited**

U.S. PATENT DOCUMENTS

D680,248 S 4/2013 Iwai et al.
D696,444 S 12/2013 Ishizuka et al.

(Continued)

FOREIGN PATENT DOCUMENTS

JP D1418197 S 10/2011
JP D1439524 S 5/2012

(Continued)

Primary Examiner — Angela J Lee

(74) *Attorney, Agent, or Firm* — Global IP Counselors,
LLP

(57) **CLAIM**

The ornamental design for a rear combination lamp for automobile, as shown and described.

DESCRIPTION

FIG. 1 is a front elevational view of a rear combination lamp for automobile in accordance with a first embodiment of our new design;

FIG. 2 is a rear elevational view of the rear combination lamp in accordance with the first embodiment of our new design of FIG. 1;

FIG. 3 is a top plan view of the rear combination lamp in accordance with the first embodiment of our new design of FIGS. 1 and 2;

FIG. 4 is a bottom plan view of the rear combination lamp in accordance with the first embodiment of our new design of FIGS. 1 to 3;

FIG. 5 is a right side elevational view of the rear combination lamp in accordance with the first embodiment of our new design of FIGS. 1 to 4;

FIG. 6 is a left side elevational view of the rear combination lamp in accordance with the first embodiment of our new design of FIGS. 1 to 5; and,

FIG. 7 is a front side perspective view of the rear combination lamp in accordance with the first embodiment of our new design of FIGS. 1 to 6.

The rear combination lamp is configured to be mounted to an automobile. The mounting structure and support structure of the rear combination lamp, shown in broken lines in FIGS. 2 to 6, form no part of the claimed design since the mounting structure and support structure are hidden when the rear combination lamp is mounted to the automobile.

In addition, the appearance of the rear side structures of the rear combination lamp as shown in broken lines in FIGS. 2 to 6 is for purpose of illustrating the boundaries of the exterior surface of the rear combination lamp, and forms no part of the claimed design.

A second embodiment of our new design is identical to the first embodiment. The second embodiment of our new design includes the mirror image of the rear combination lamp shown in FIGS. 1 to 7.

1 Claim, 7 Drawing Sheets

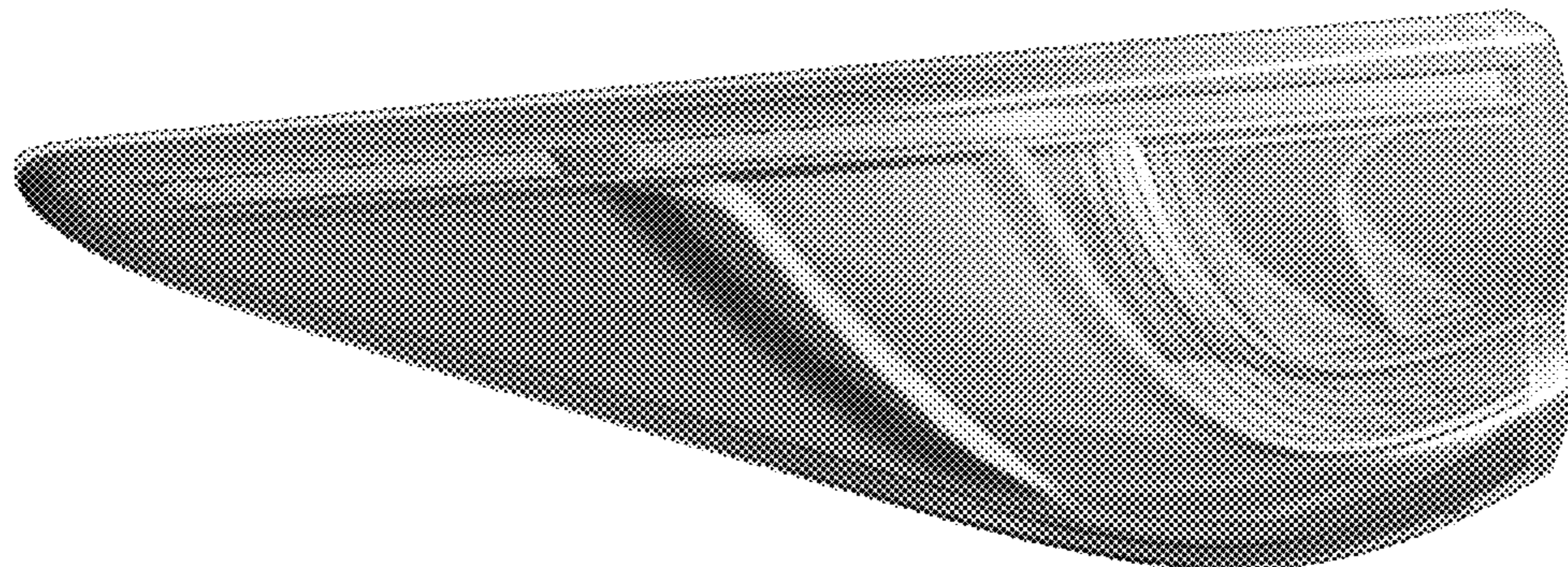

(58) **Field of Classification Search**

CPC F21S 48/00; F21S 48/10; F21S 48/115;
 F21S 48/225; F21S 48/1233; F21S
 48/1266; F21S 48/1388; F21S 48/2268;
 F21V 21/04

See application file for complete search history.

(56) **References Cited**

U.S. PATENT DOCUMENTS

D701,983 S * 4/2014 Kong D26/28
 D706,965 S 6/2014 Katou et al.
 D735,920 S * 8/2015 Honda D26/28
 D745,717 S * 12/2015 Wu D26/28
 D748,305 S * 1/2016 Miyazawa D26/28
 D749,251 S * 2/2016 Nakahara D26/28
 D752,780 S * 3/2016 Hall D26/28
 D752,783 S * 3/2016 Whang D26/28
 D755,420 S * 5/2016 Ko D26/28
 D757,967 S * 5/2016 Kim D26/28
 D760,411 S * 6/2016 Andersson Murkett D26/28
 D760,412 S * 6/2016 Andersson Murkett D26/28
 D761,463 S * 7/2016 Lai D26/28
 D761,978 S * 7/2016 Lai D26/28

FOREIGN PATENT DOCUMENTS

JP D1444611 S 6/2012
 JP D1444786 S 6/2012
 JP D1445132 S 7/2012
 JP D1450478 S 9/2012
 JP D1474632 S 7/2013
 JP D1458893 S 12/2013
 JP D1485584 S 12/2013
 JP D1491430 S 3/2014
 JP D1493070 S 3/2014
 JP D1444229 S 6/2014
 JP D1472544 S 6/2014
 JP D1472891 S 6/2014
 JP D1500453 S 6/2014
 JP D1503583 S 7/2014
 JP D1479716 S 9/2014
 JP D1480240 S 9/2014
 JP D1510475 S 11/2014
 JP D1513122 S 12/2014
 JP D1517667 S 2/2015
 JP D1518110 S 2/2015
 JP D1518112 S 2/2015
 JP D1525055 S 6/2015

* cited by examiner

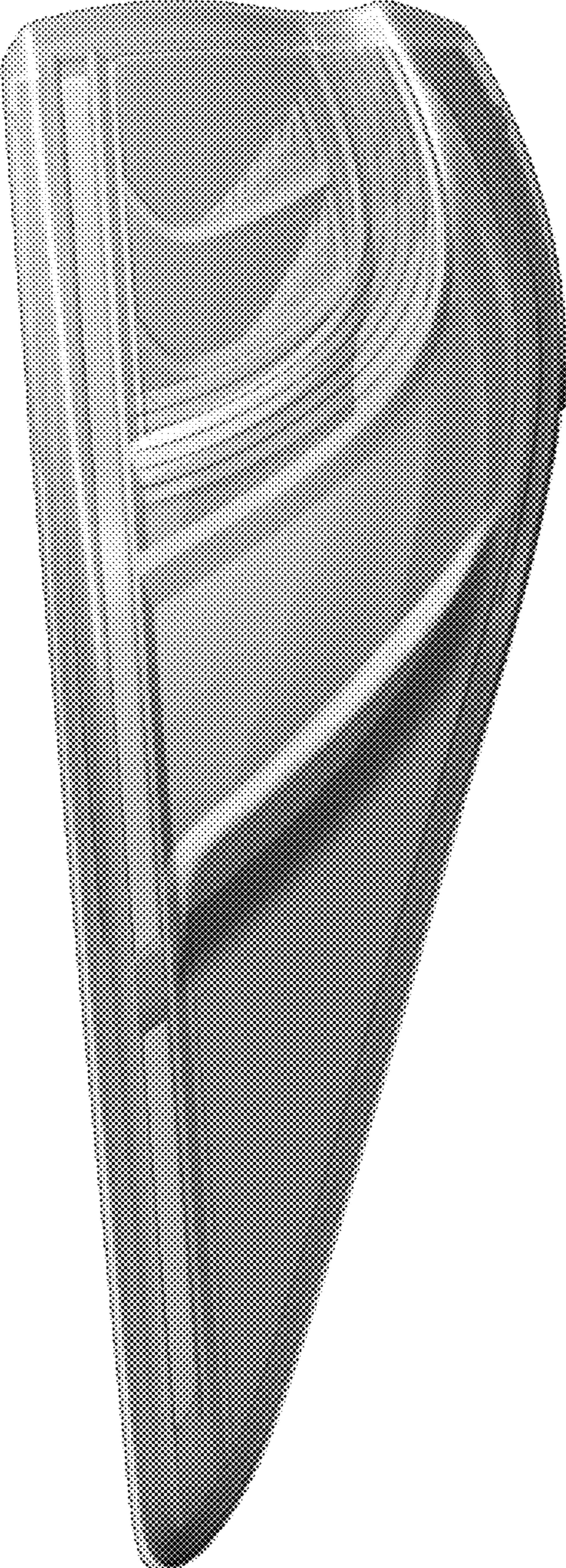

FIG. 1

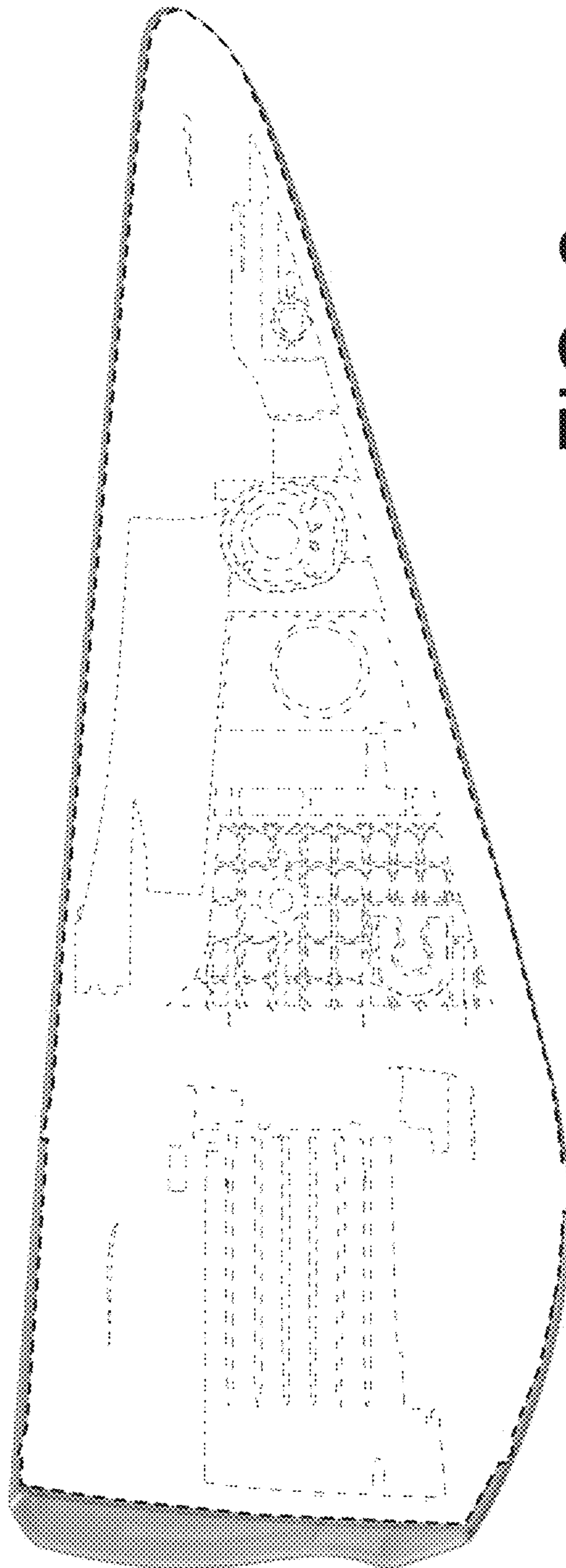

FIG. 2

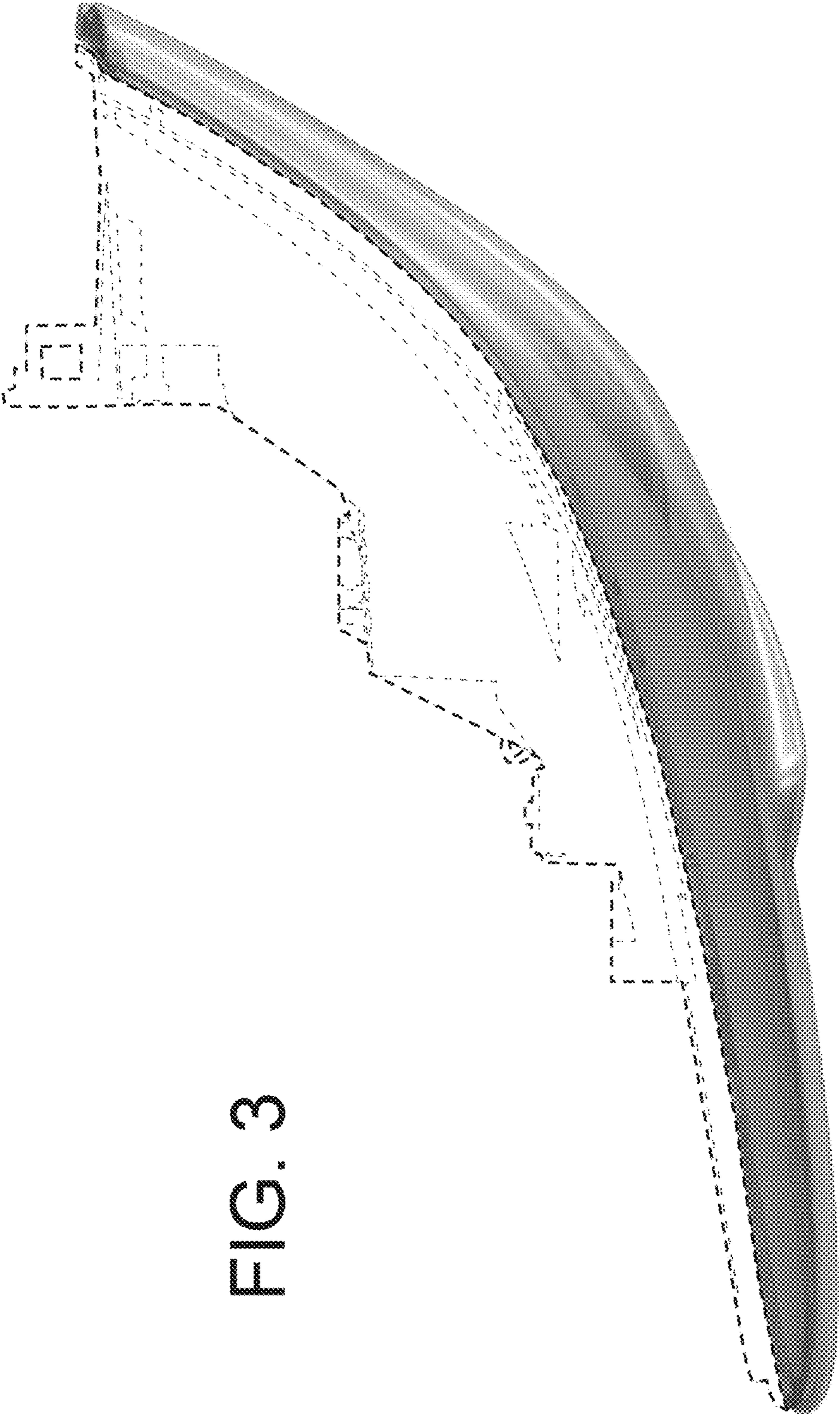

FIG. 3

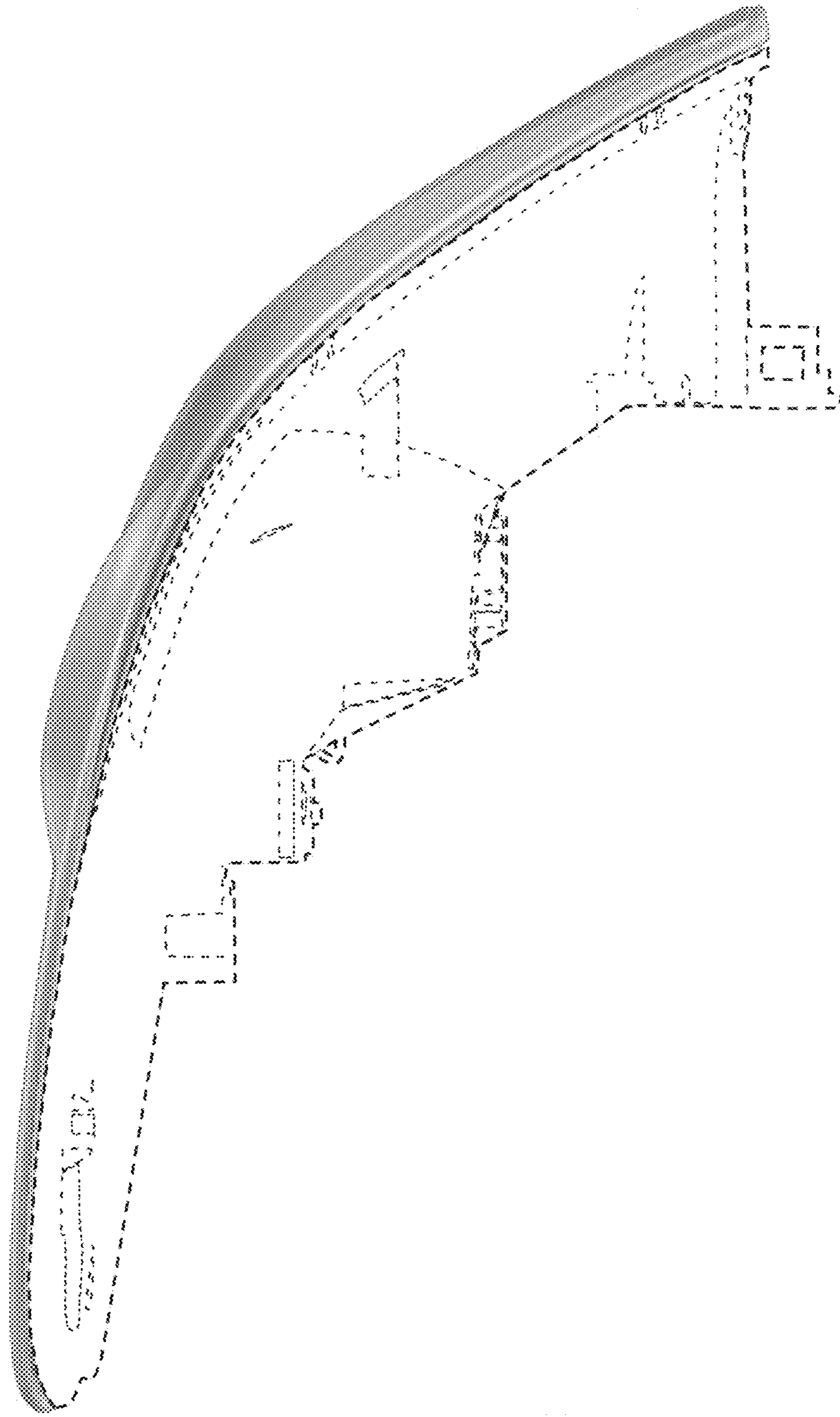

FIG. 4

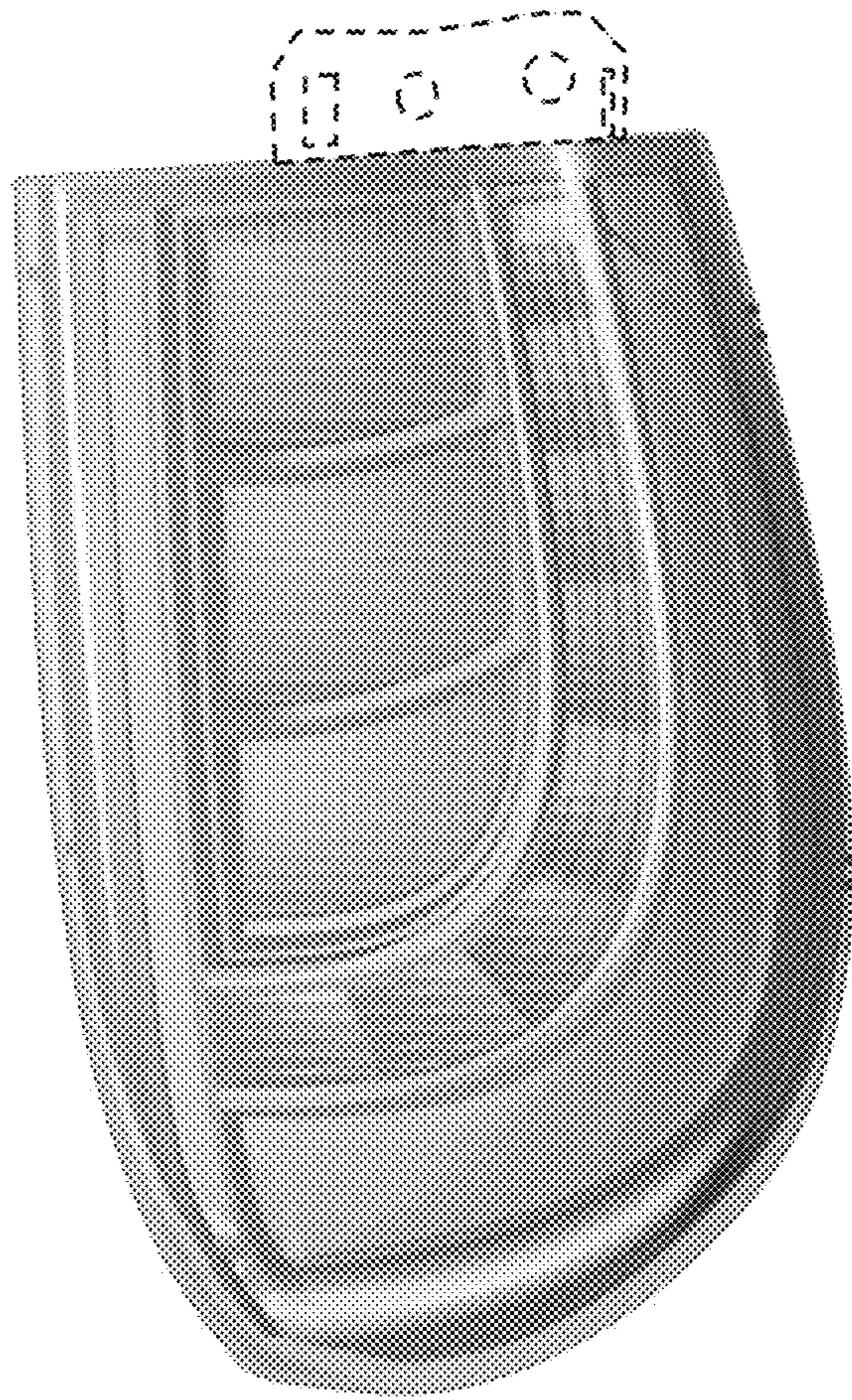

FIG. 5

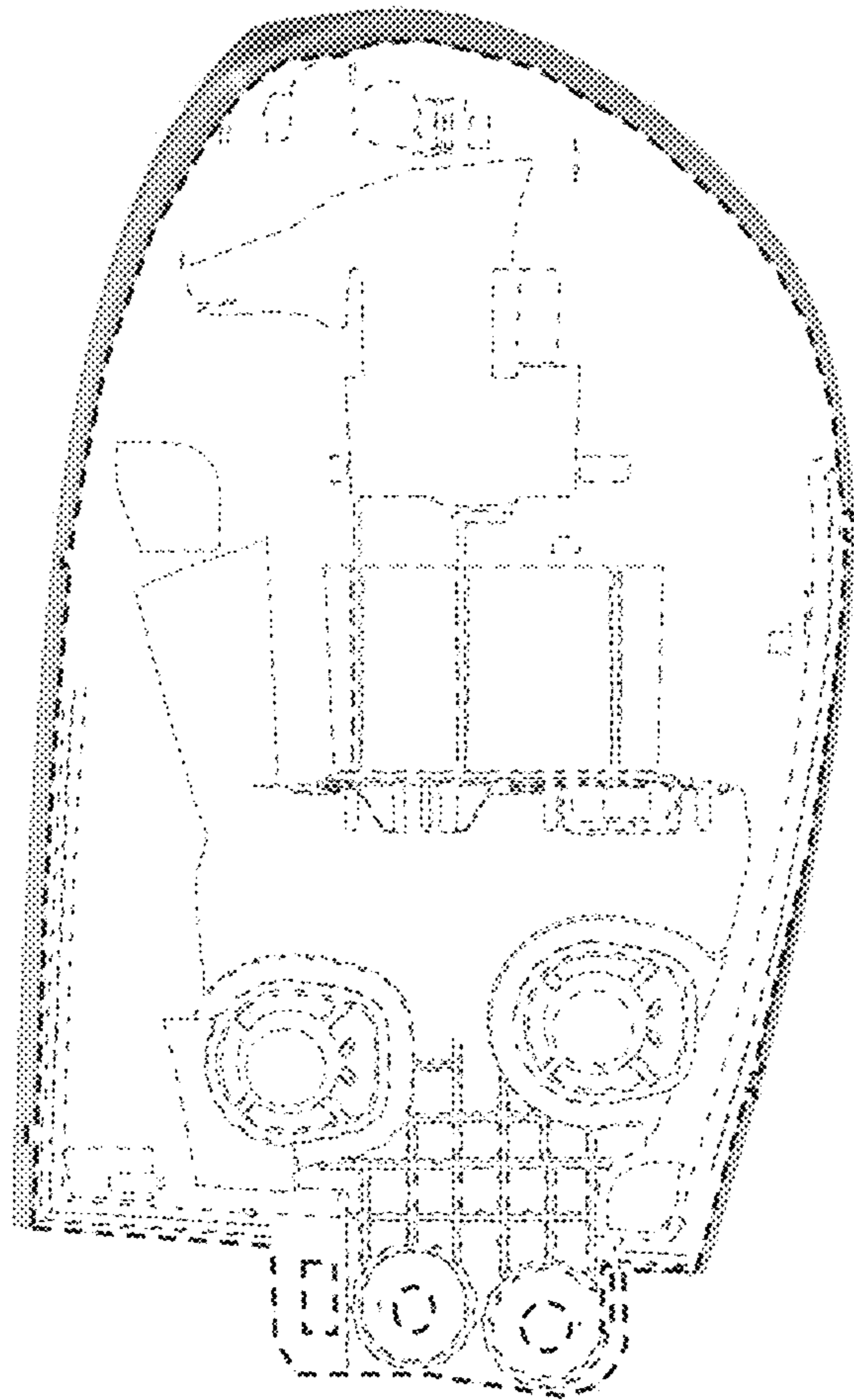

FIG. 6

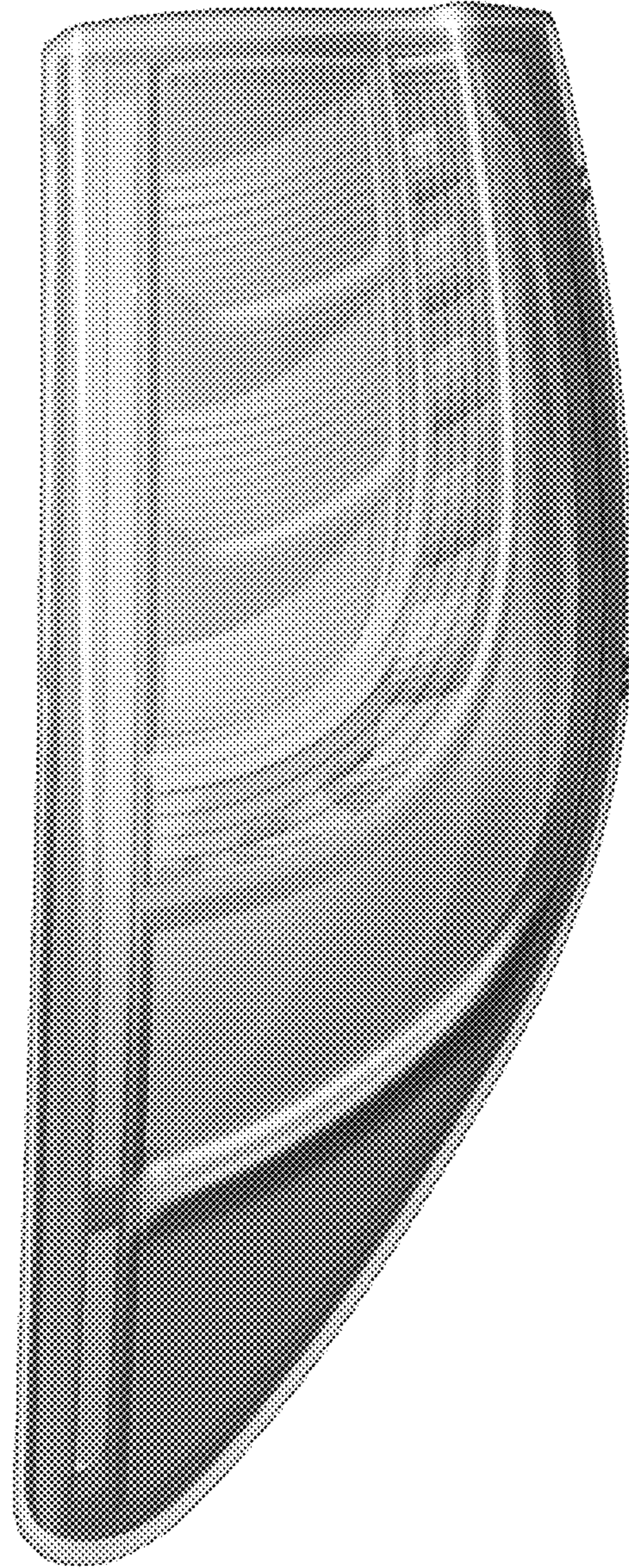

FIG. 7