

US00D782628S

(12) **United States Design Patent**  
**Schachter et al.**

(10) **Patent No.:** **US D782,628 S**  
(45) **Date of Patent:** **\*\* Mar. 28, 2017**

(54) **BATHTUB**

(71) Applicant: **Fleurco Products Inc.**, Ville  
Saint-Laurent (CA)

(72) Inventors: **Robert Schachter**, Montreal (CA);  
**Michael Salamon**, Miami, FL (US)

(\*\*) Term: **15 Years**

(21) Appl. No.: **29/554,810**

(22) Filed: **Feb. 16, 2016**

(30) **Foreign Application Priority Data**

Aug. 25, 2015 (CA) ..... 163973

(51) **LOC (10) Cl.** ..... **23-02**

(52) **U.S. Cl.**  
USPC ..... **D23/277**

(58) **Field of Classification Search**  
USPC ..... D23/277, 280.1, 275, 273, 303-306  
CPC ..... A47K 3/02  
See application file for complete search history.

(56) **References Cited**

U.S. PATENT DOCUMENTS

D672,017 S \* 12/2012 Garrels ..... D23/277

\* cited by examiner

*Primary Examiner* — Robert Delehanty

(74) *Attorney, Agent, or Firm* — Eric L. Lane; Green  
Patent Law

(57) **CLAIM**

The ornamental design of a bathtub, as shown and described.

**DESCRIPTION**

FIG. 1 is a front perspective view showing the design;  
FIG. 2 is a front view thereof;  
FIG. 3 is a left side view thereof;  
FIG. 4 is a right side view thereof;  
FIG. 5 is a top view thereof;  
FIG. 6 is a rear view thereof; and,  
FIG. 7 is a bottom view thereof.

**1 Claim, 7 Drawing Sheets**

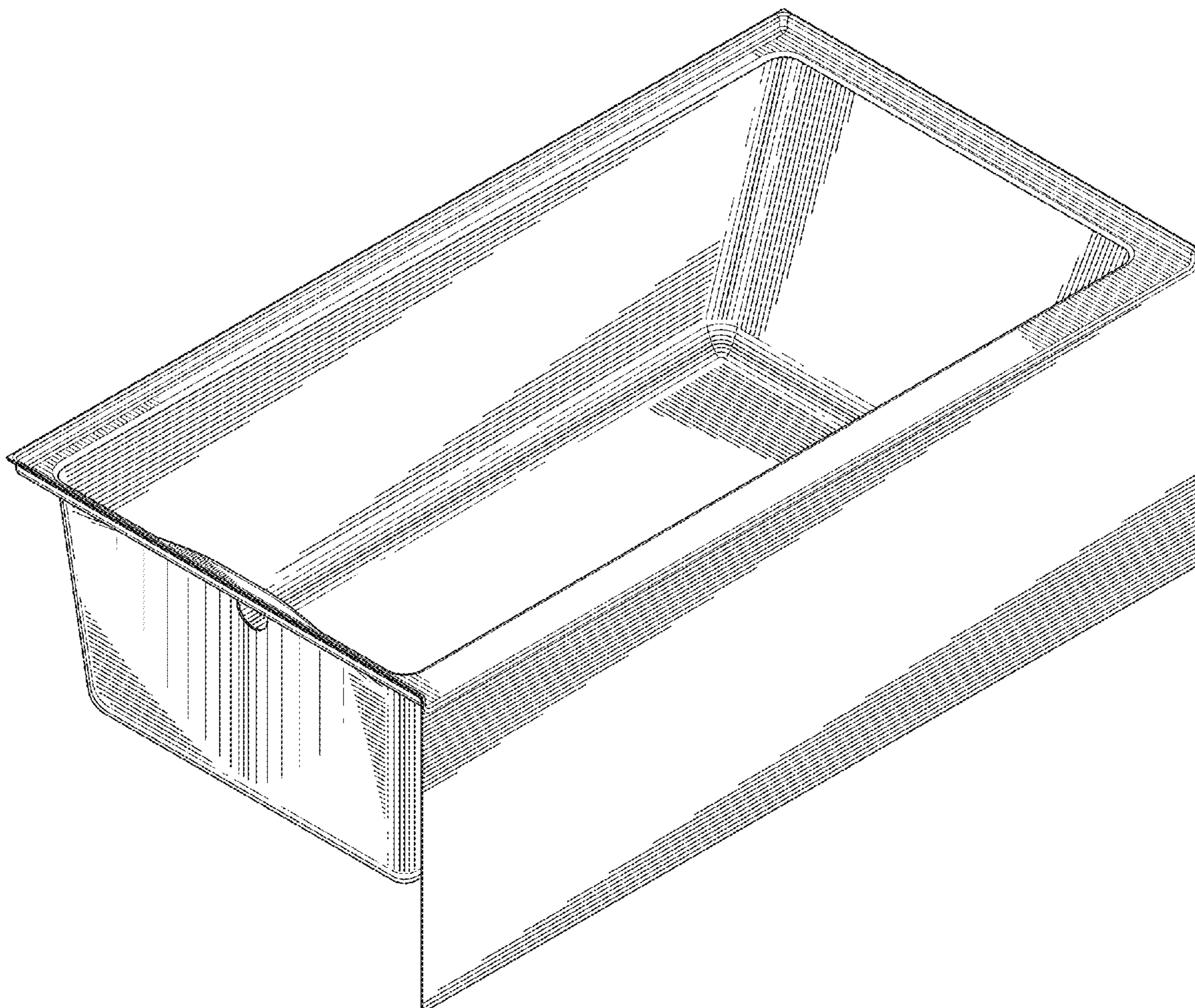



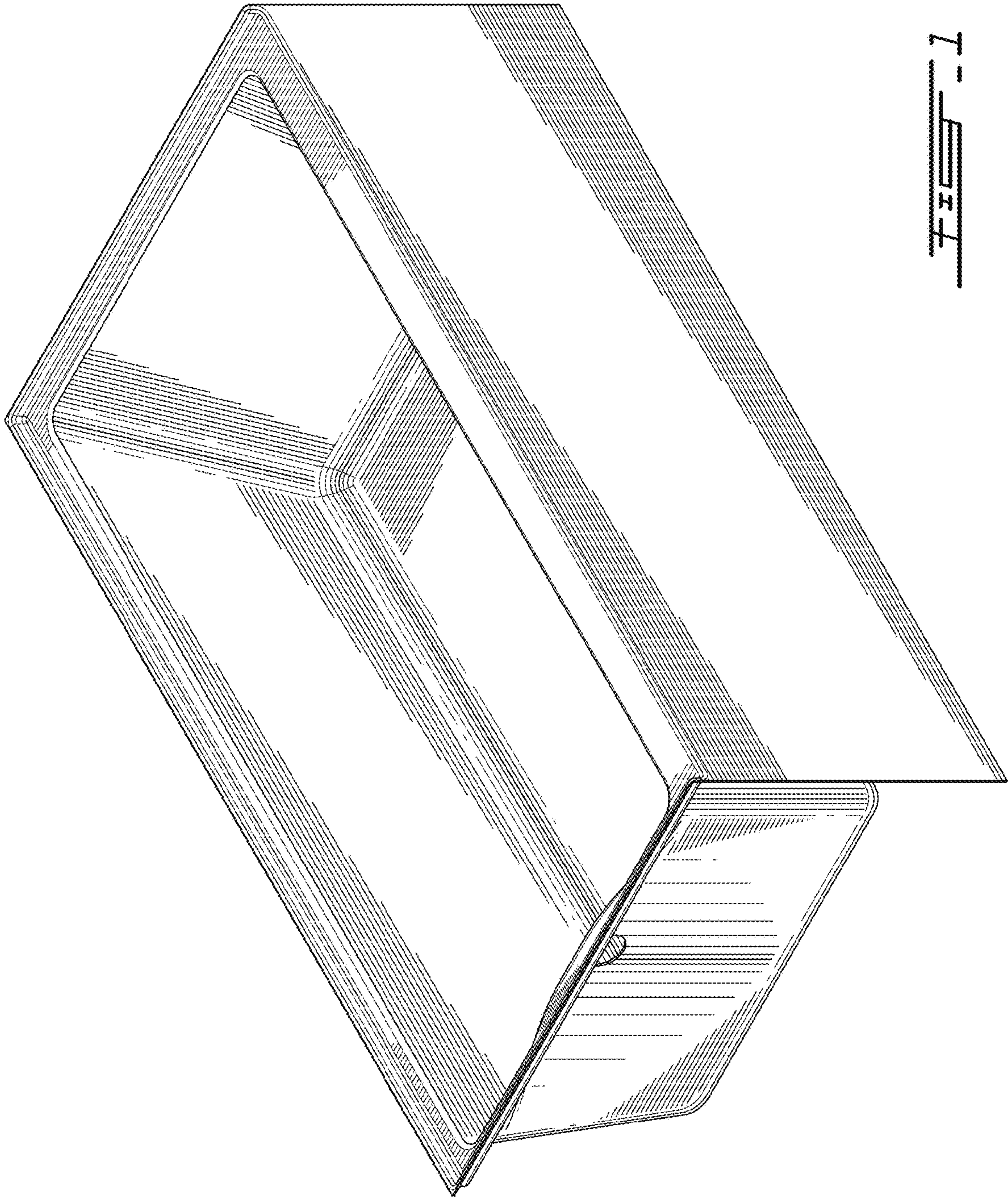

FIG. 1

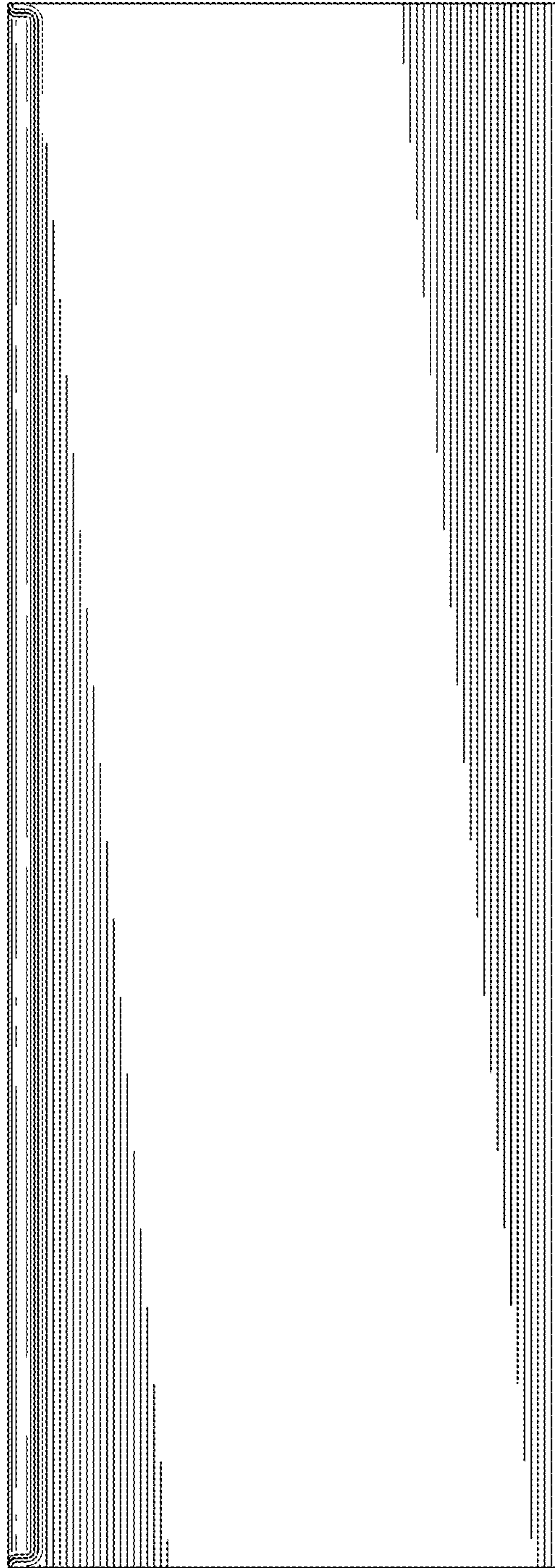

FIG. 2

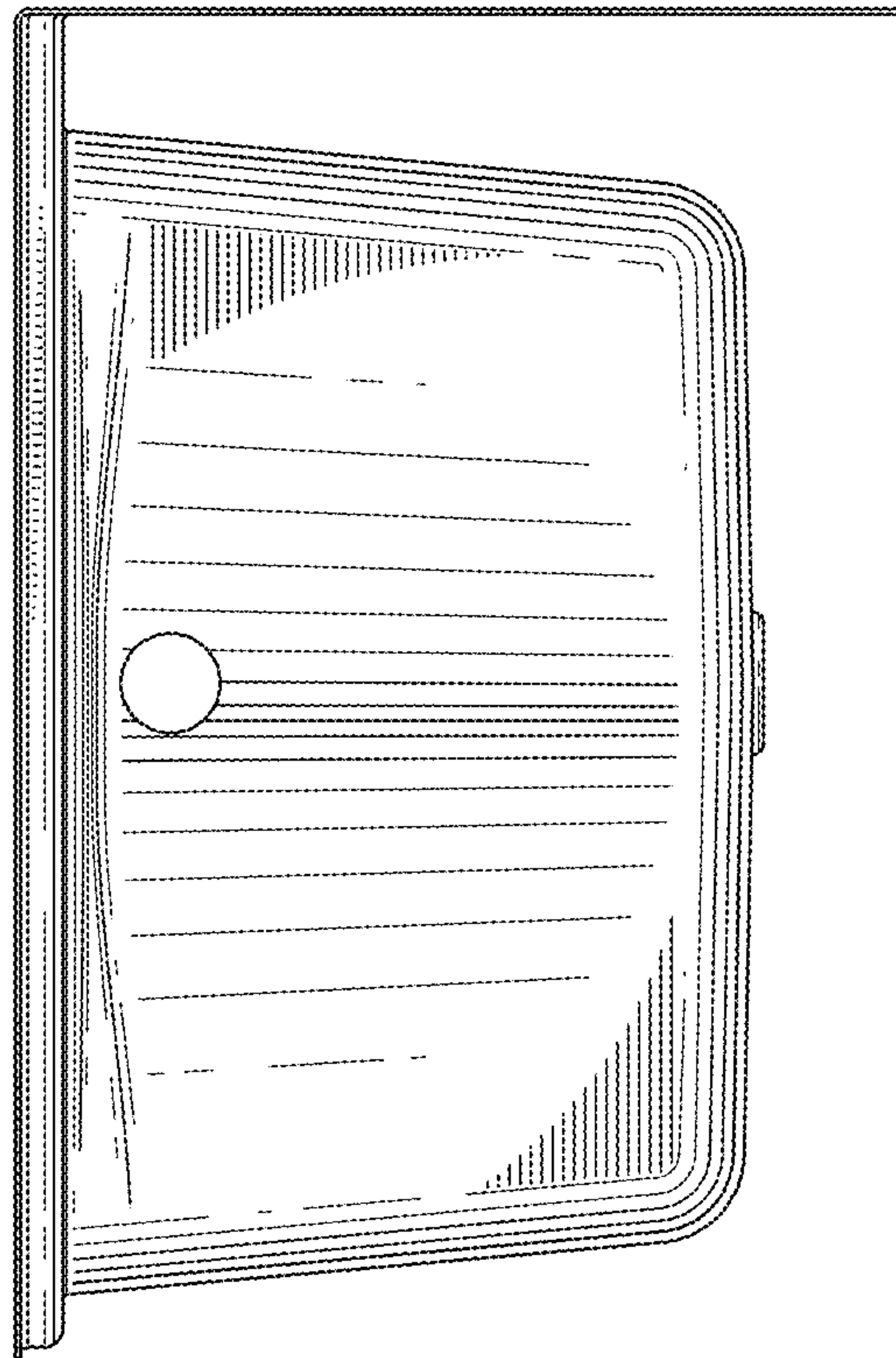

FIG. 3



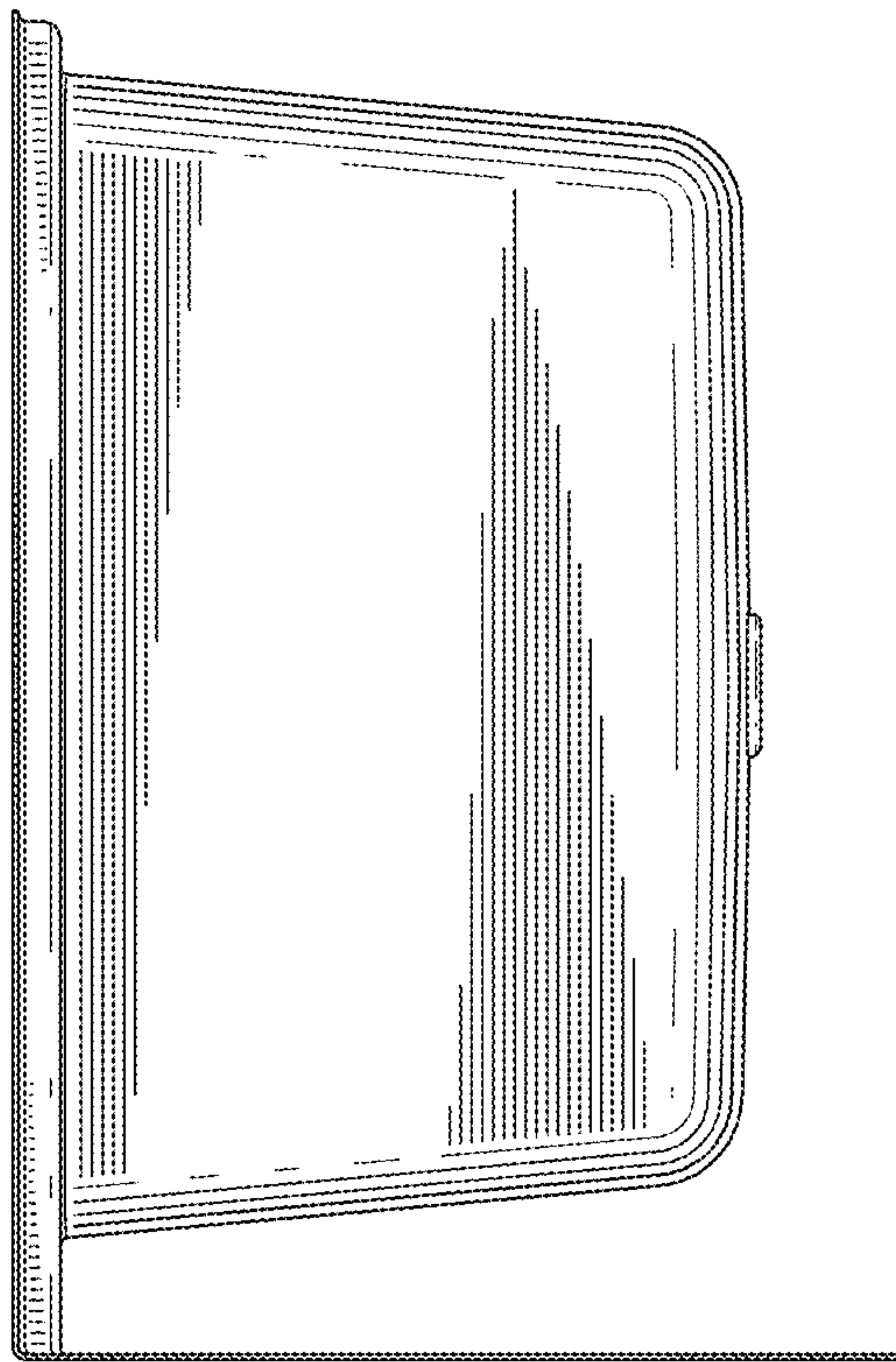

FIG. 4

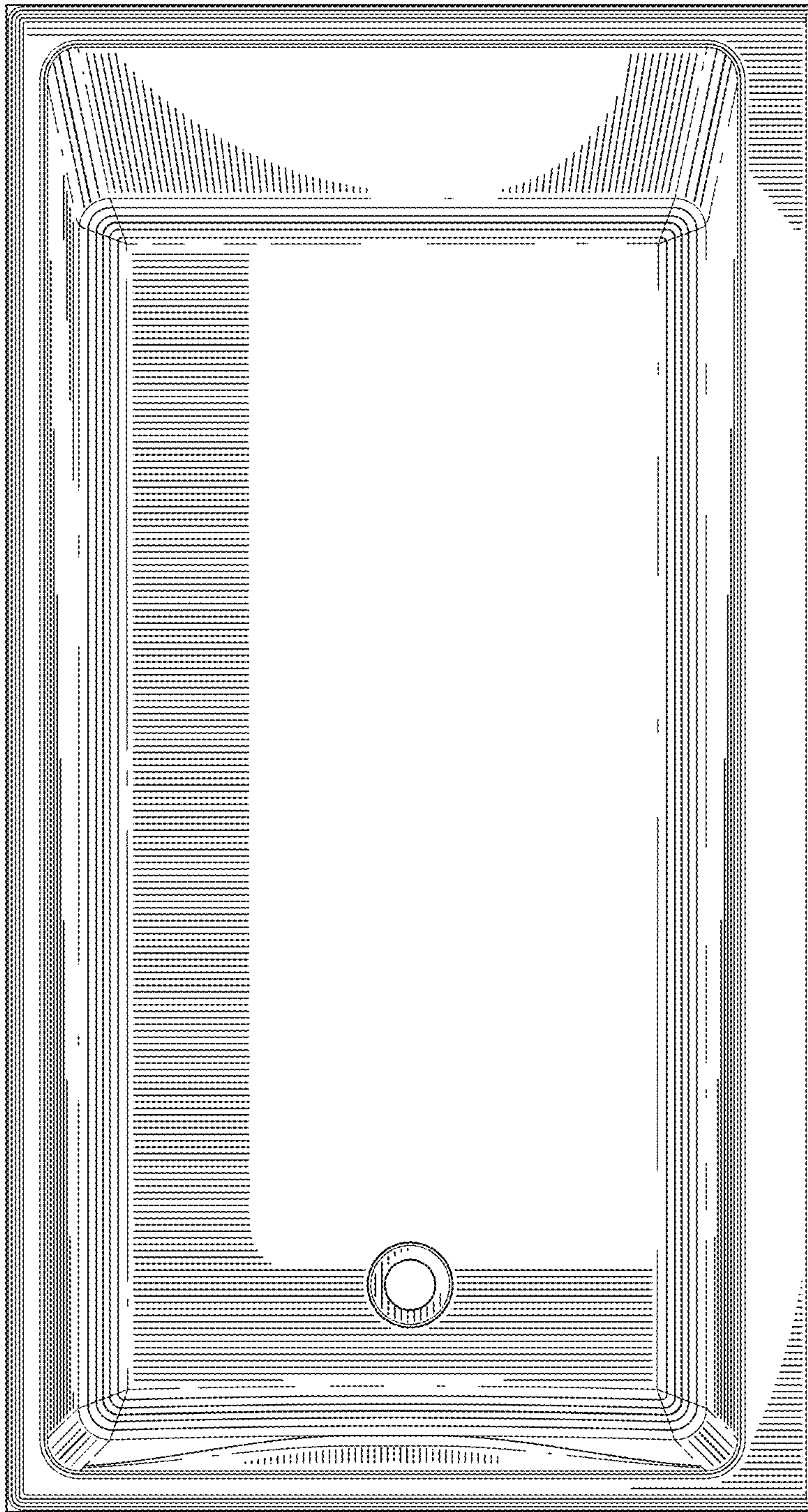

FIG. 5

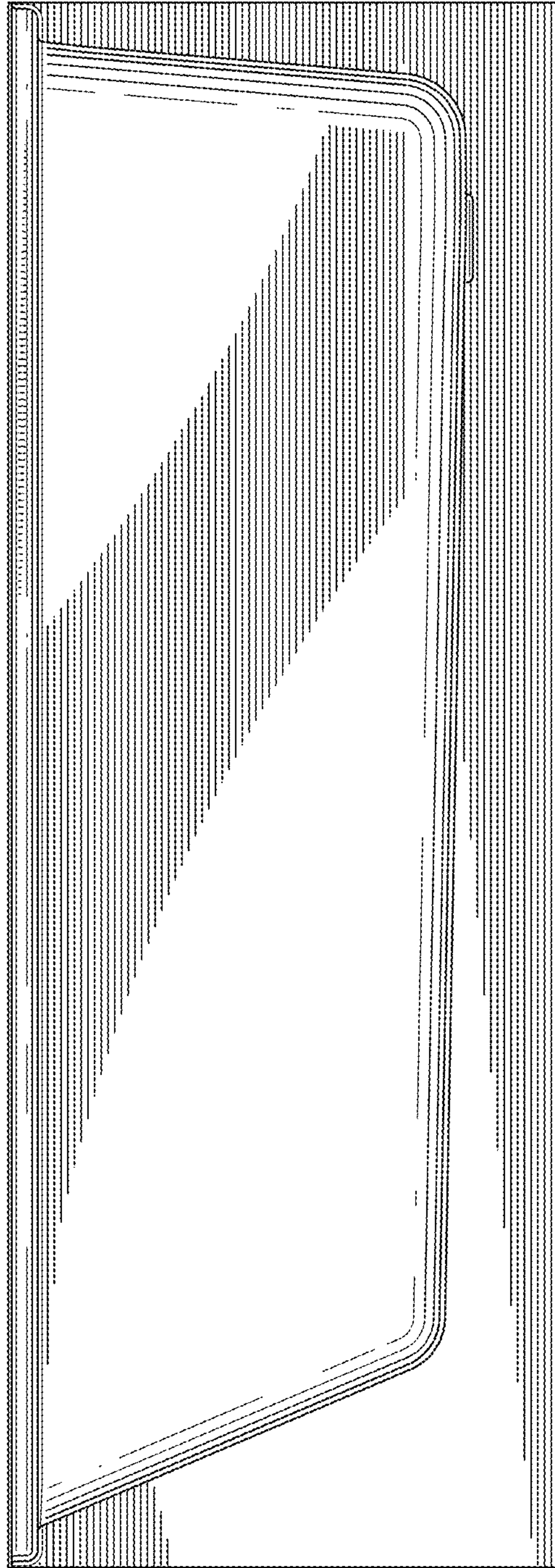

FIG. 6





FIG. 7