



US00D782574S

(12) **United States Design Patent**  
**the Losen et al.**

(10) **Patent No.:** **US D782,574 S**

(45) **Date of Patent:** **\*\* Mar. 28, 2017**

- (54) **STORAGE UNIT**
- (71) Applicant: **Savor Goods, LLC**, Sag Harbor, NY (US)
- (72) Inventors: **Karla the Losen**, New York, NY (US);  
**Jennifer Nevins**, New York, NY (US)
- (73) Assignee: **Savor Goods, LLC**, Sag Harbor, NY (US)
- (\*\*) Term: **15 Years**
- (21) Appl. No.: **29/531,055**
- (22) Filed: **Jun. 23, 2015**
- (51) **LOC (10) Cl.** ..... **19-02**
- (52) **U.S. Cl.**  
USPC ..... **D19/90**
- (58) **Field of Classification Search**  
USPC ..... D3/304, 305, 310–315; D6/407, 627,  
D6/675, 683, 683.1; D7/600.1–600.4,  
D7/601; D9/737, 414, 432; D19/75,  
D19/77–80, 86–87, 90–92  
CPC ..... B42F 7/10; B42F 7/12; B42F 7/06; B42F  
7/145; B42F 17/02; B42F 17/12; B43M  
99/00; B43M 99/001; B43M 99/008;  
A47B 6/00; A47B 47/00; A47B 47/0033;  
A47B 47/0041; B65D 5/566  
See application file for complete search history.

(56) **References Cited**

**U.S. PATENT DOCUMENTS**

- 522,237 A \* 7/1894 Sexton ..... B42F 17/02  
190/16
- 1,692,865 A \* 11/1928 Riederer ..... B42F 17/02  
206/425
- 3,216,426 A \* 11/1965 Furrer ..... B42F 7/145  
211/113

- 3,332,600 A \* 7/1967 Guernsey ..... B65D 5/38  
229/125.125
- 3,439,861 A \* 4/1969 Olson ..... B65D 5/10  
229/108
- 3,455,462 A \* 7/1969 Morgan ..... A47B 47/00  
211/42
- 3,517,854 A \* 6/1970 Ziegler ..... B42F 7/145  
206/556
- 3,592,344 A \* 7/1971 Schade ..... A47B 47/00  
206/557
- 3,726,411 A \* 4/1973 Jones ..... A47F 5/0025  
211/126.13
- 3,949,928 A \* 4/1976 Perkins ..... B65D 5/22  
229/125.125
- 4,322,000 A \* 3/1982 Struble ..... G11B 23/0233  
206/387.1
- 4,895,267 A \* 1/1990 Karlsson ..... B42F 17/02  
220/4.28

(Continued)

*Primary Examiner* — Elizabeth Albert

(74) *Attorney, Agent, or Firm* — Rankin, Hill & Clark  
LLP

(57) **CLAIM**

The ornamental design for a storage unit, as shown and described.

**DESCRIPTION**

FIG. 1 is an exploded perspective view of a storage unit; FIG. 2 is a front elevation view thereof; FIG. 3 is a rear elevation view thereof; FIG. 4 is a left side elevation view thereof; FIG. 5 is a right side elevation view thereof; FIG. 6 is a top plan view thereof; and FIG. 7 is a bottom plan view thereof; and, FIG. 8 is a perspective view of the storage unit shown assembled.

The broken lines in the drawings are included to show features that form no part of the claimed design.

**1 Claim, 8 Drawing Sheets**

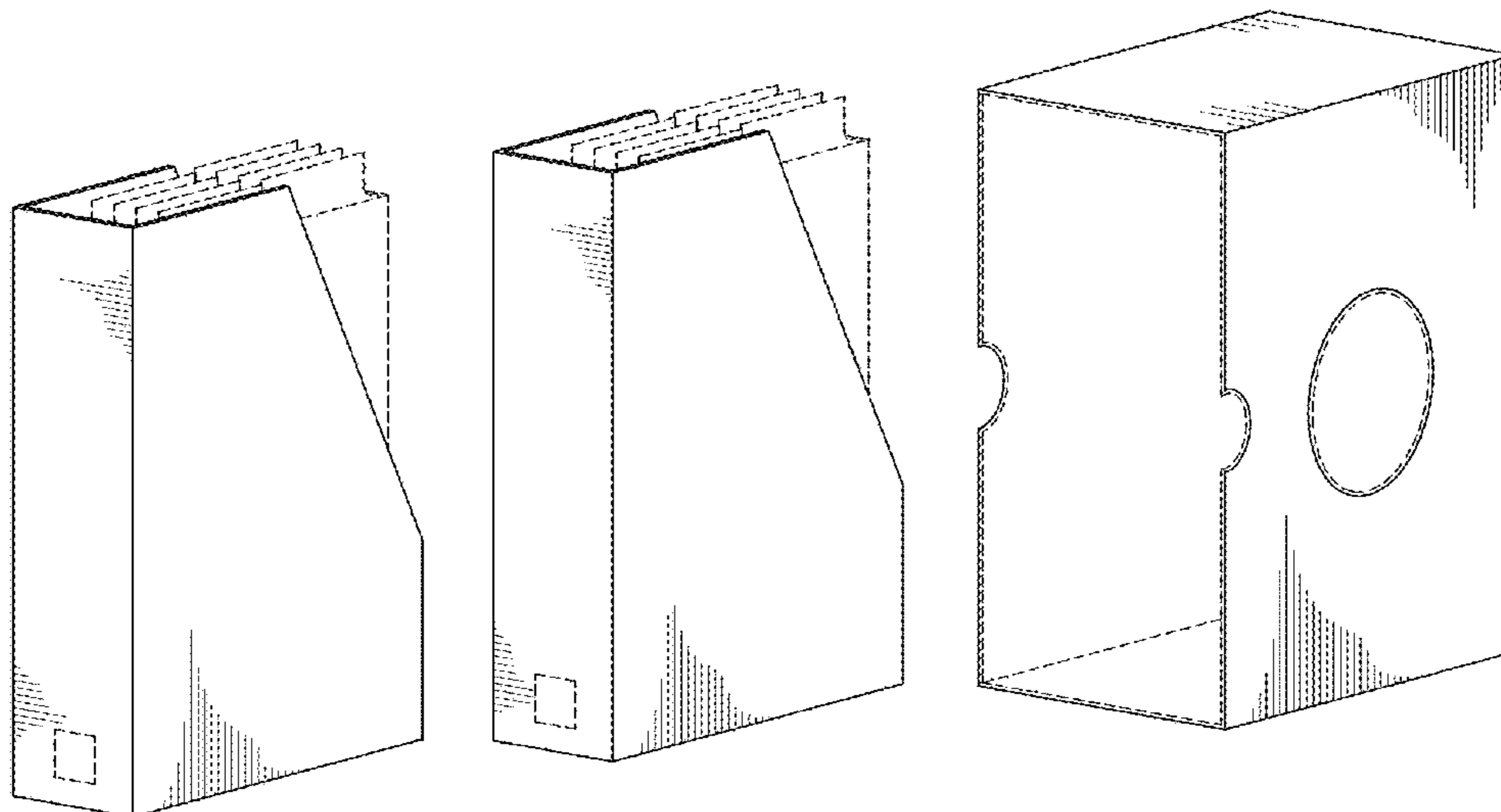

(56)

References Cited

U.S. PATENT DOCUMENTS

4,909,398 A \* 3/1990 Santucci ..... A47F 7/147  
 211/11  
 D335,996 S \* 6/1993 Evenson ..... D19/90  
 5,224,608 A \* 7/1993 Paquette ..... B42F 15/0088  
 211/206  
 D342,026 S \* 12/1993 Cross ..... D19/86  
 5,351,826 A \* 10/1994 Chen ..... B42F 7/145  
 206/425  
 5,372,256 A \* 12/1994 Chen ..... B42F 7/145  
 206/425  
 D365,487 S \* 12/1995 Chen ..... D6/629  
 D381,691 S \* 7/1997 Miyake ..... D19/75  
 5,655,656 A \* 8/1997 Gottlieb ..... G11B 33/0494  
 206/232  
 5,707,003 A \* 1/1998 Miyake ..... B42F 7/145  
 206/245  
 D395,580 S \* 6/1998 Kendrick ..... D19/90  
 D500,802 S \* 1/2005 DeCarlo ..... D19/90  
 D502,966 S \* 3/2005 çakir ..... D19/90  
 7,299,968 B2 \* 11/2007 Mittmann ..... B65D 5/38  
 229/125.125  
 D562,405 S \* 2/2008 Gusdorf ..... D19/90  
 2015/0202721 A1 \* 7/2015 Gu ..... B23K 11/04  
 219/100

\* cited by examiner

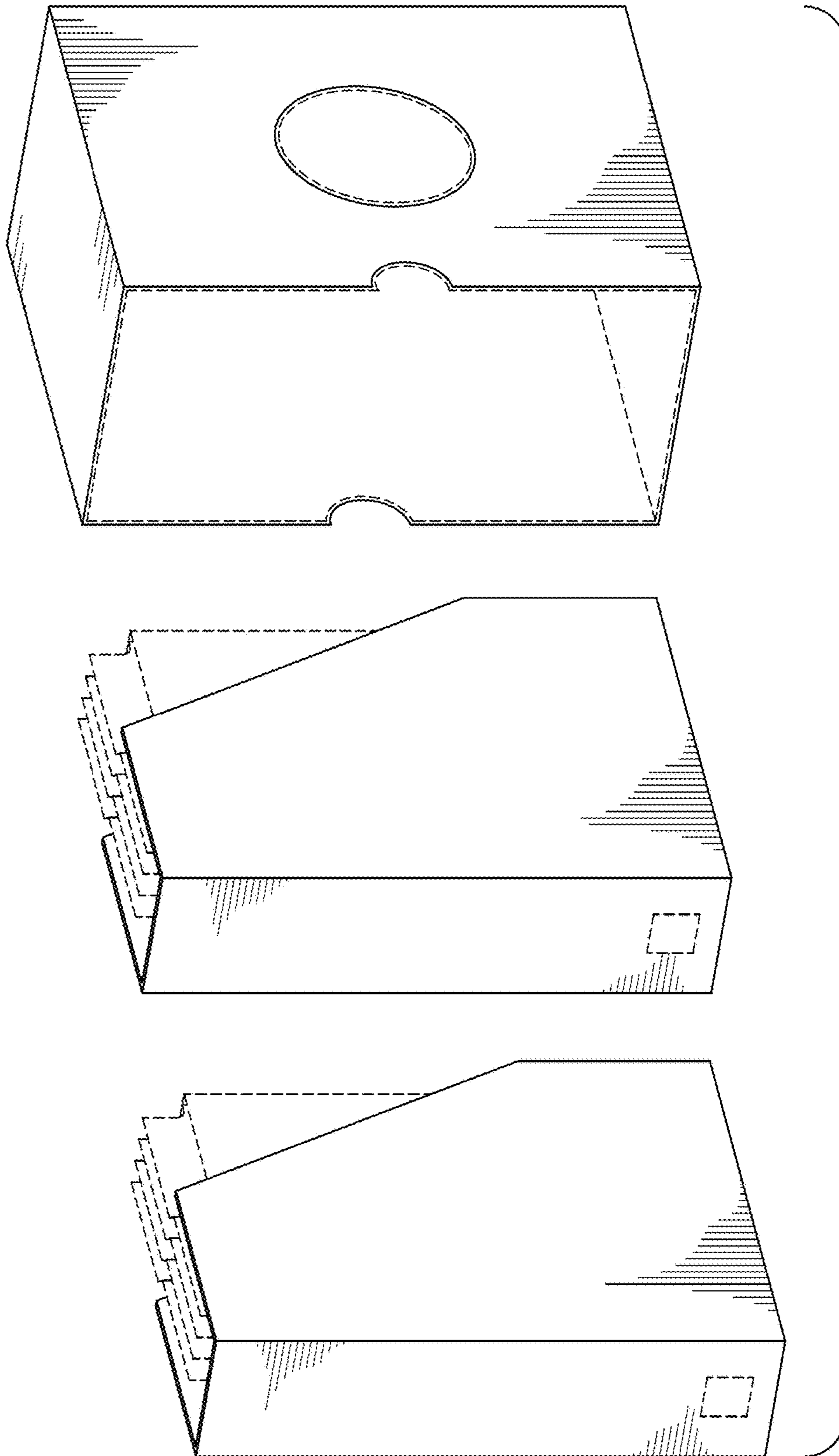

FIG. 1

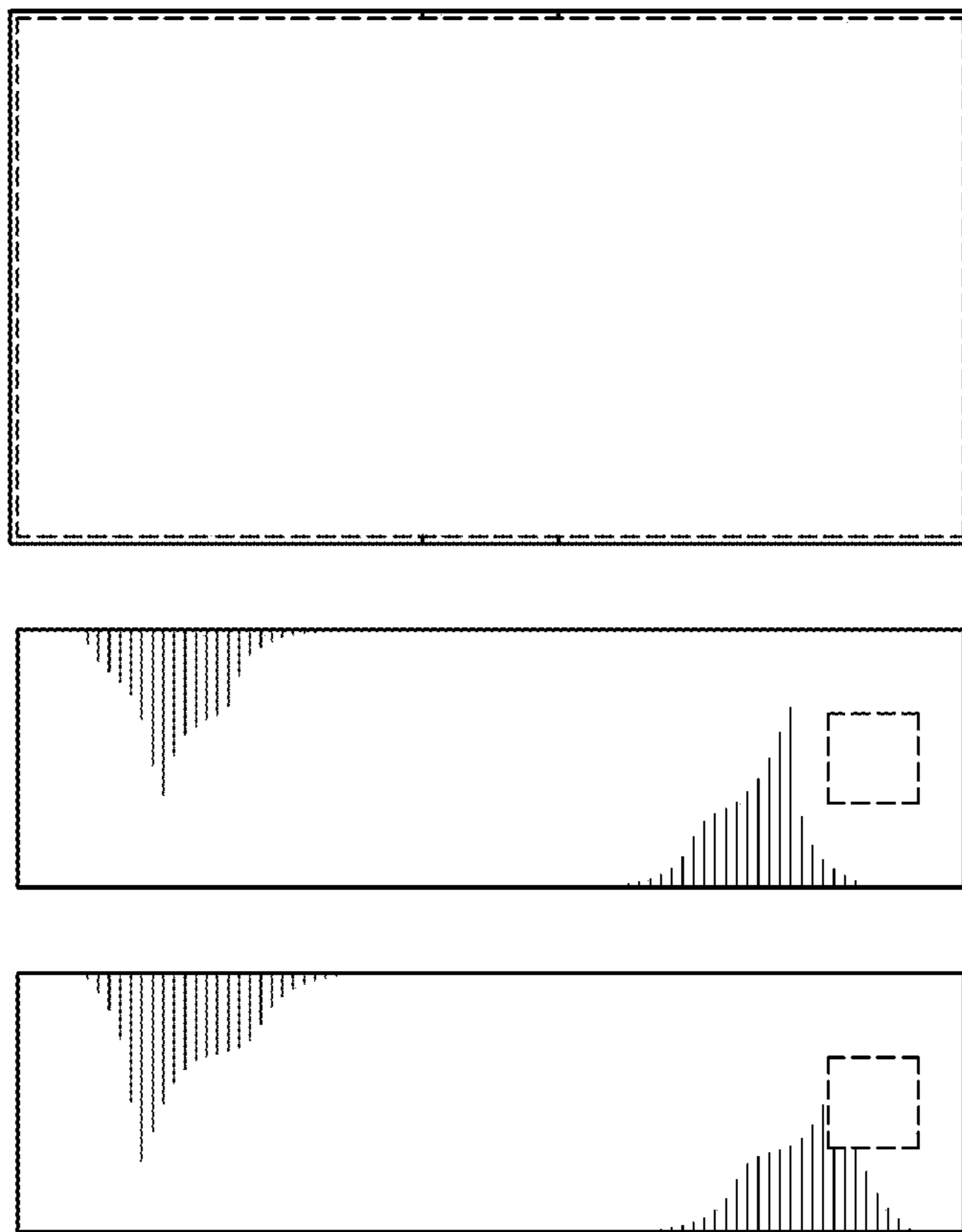

FIG. 2

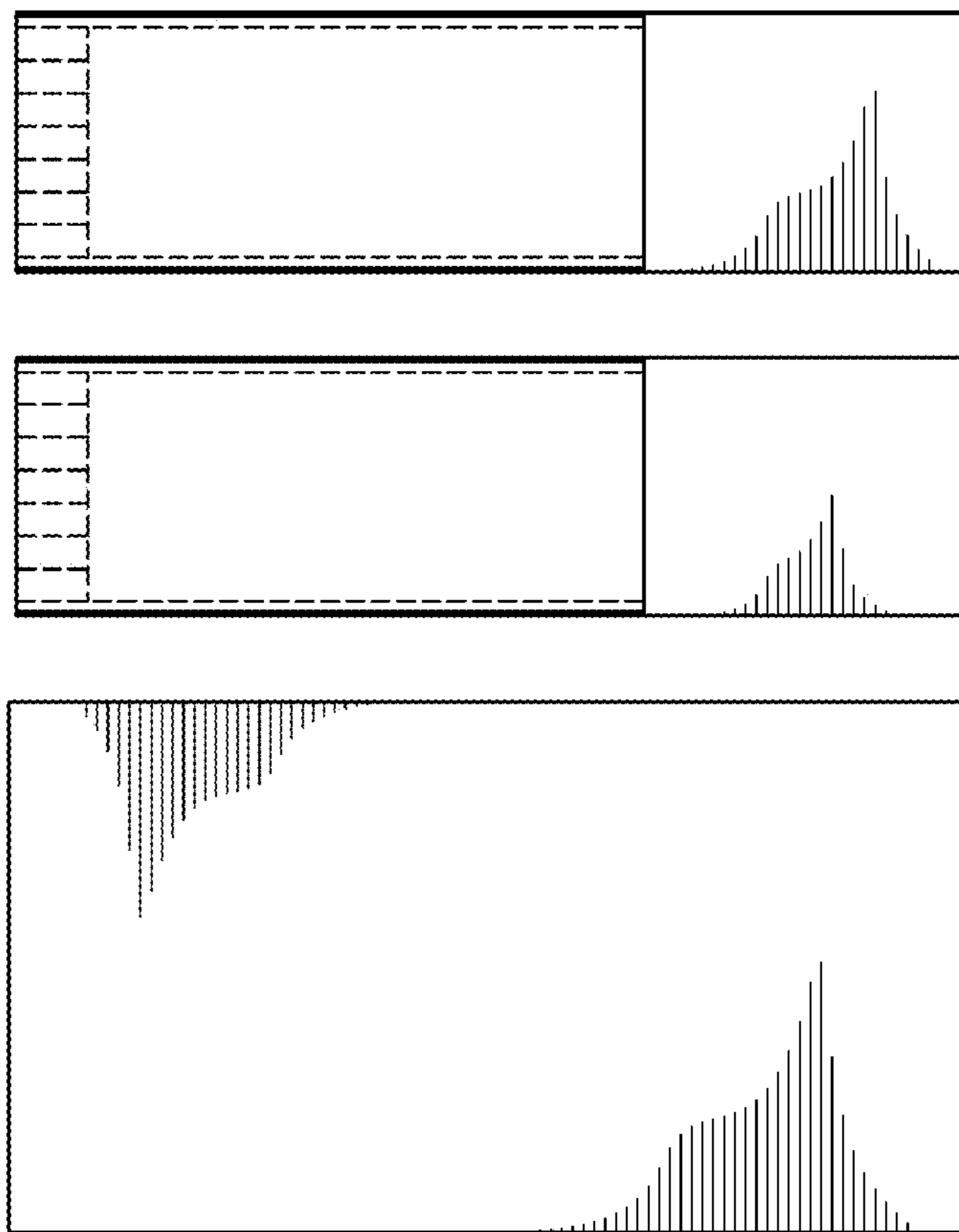

FIG.3

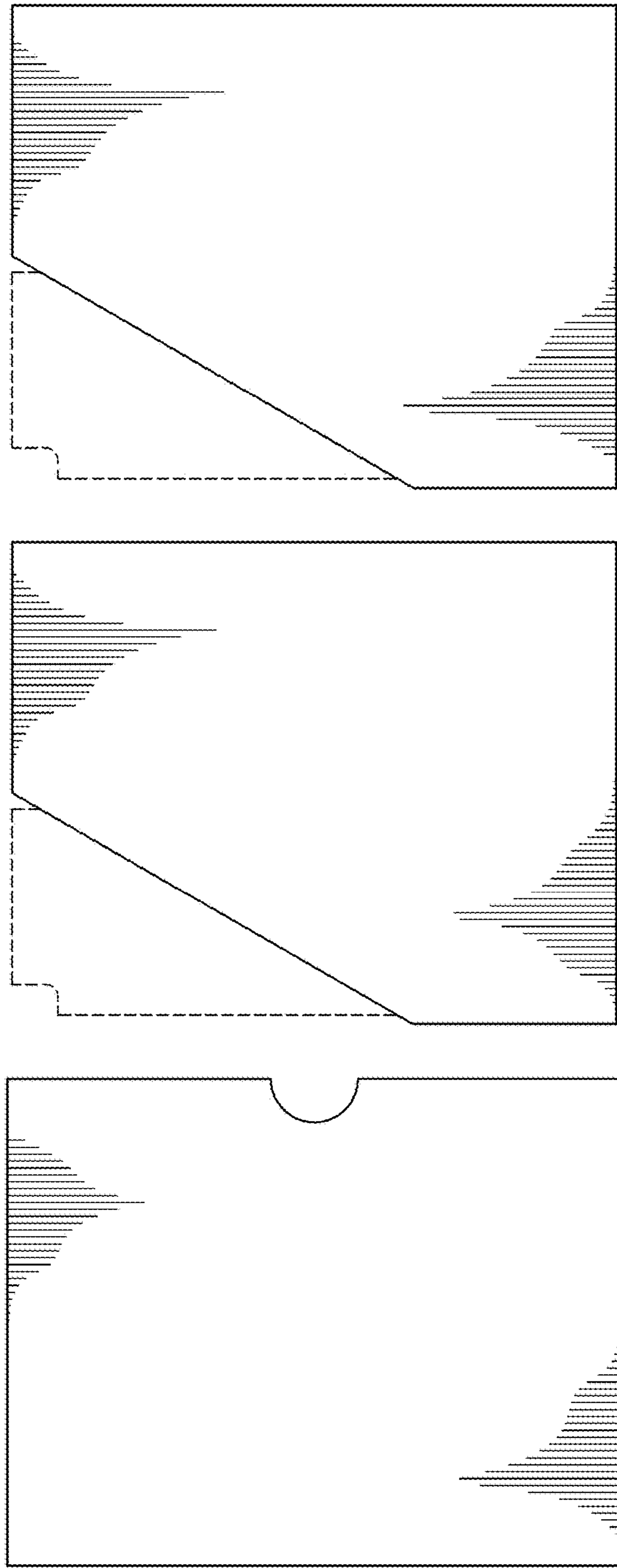

FIG. 4

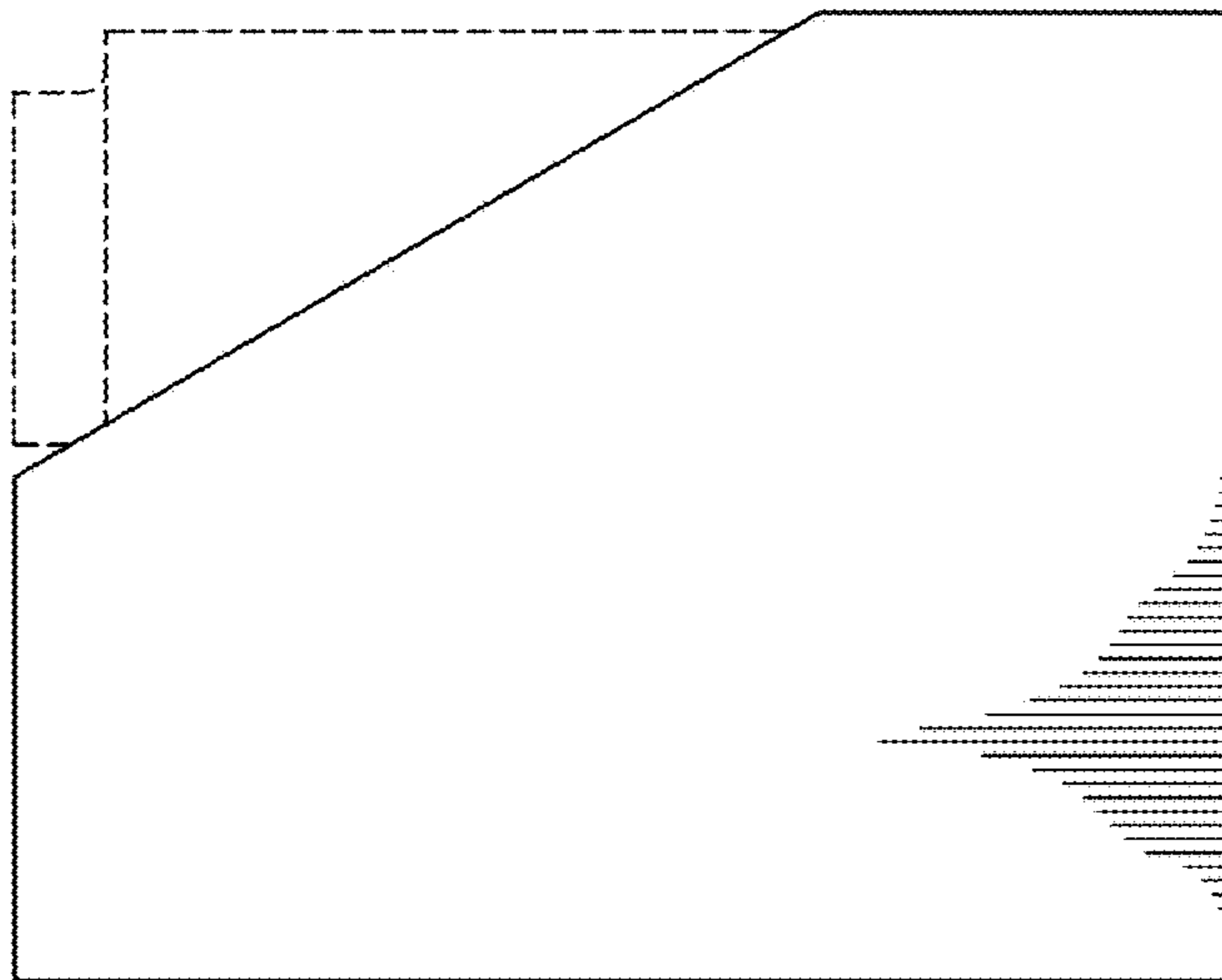
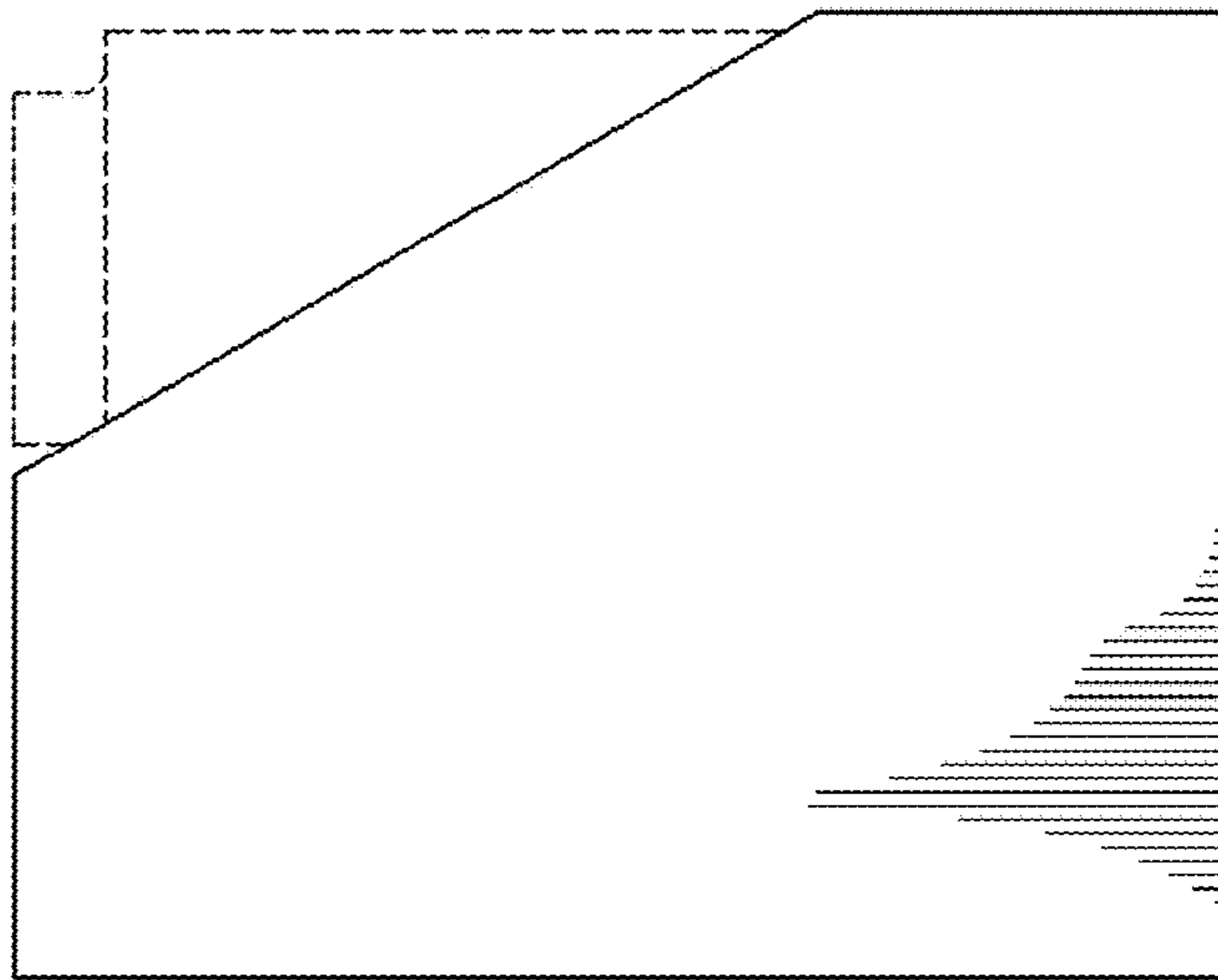
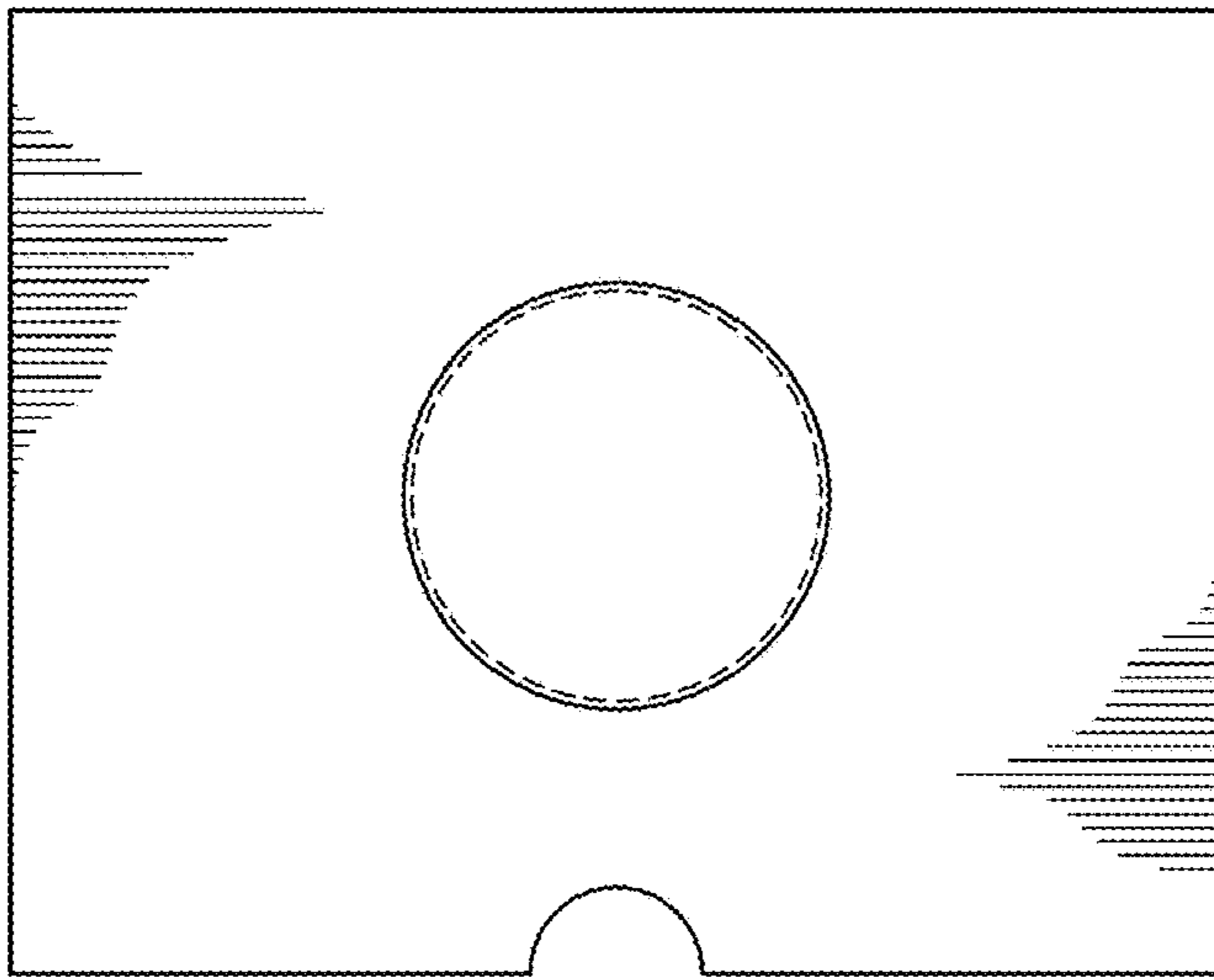

FIG. 5

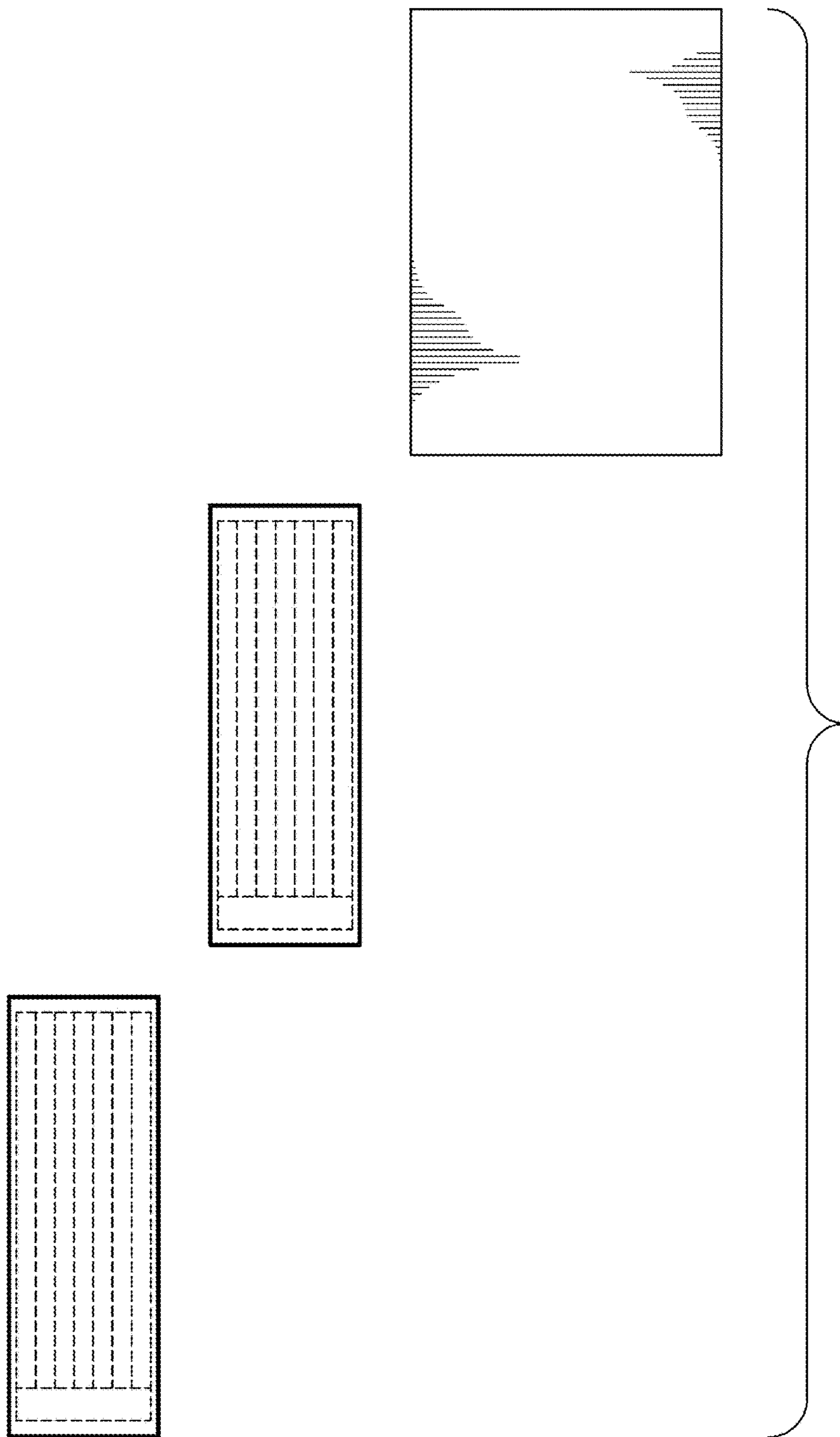

FIG. 6



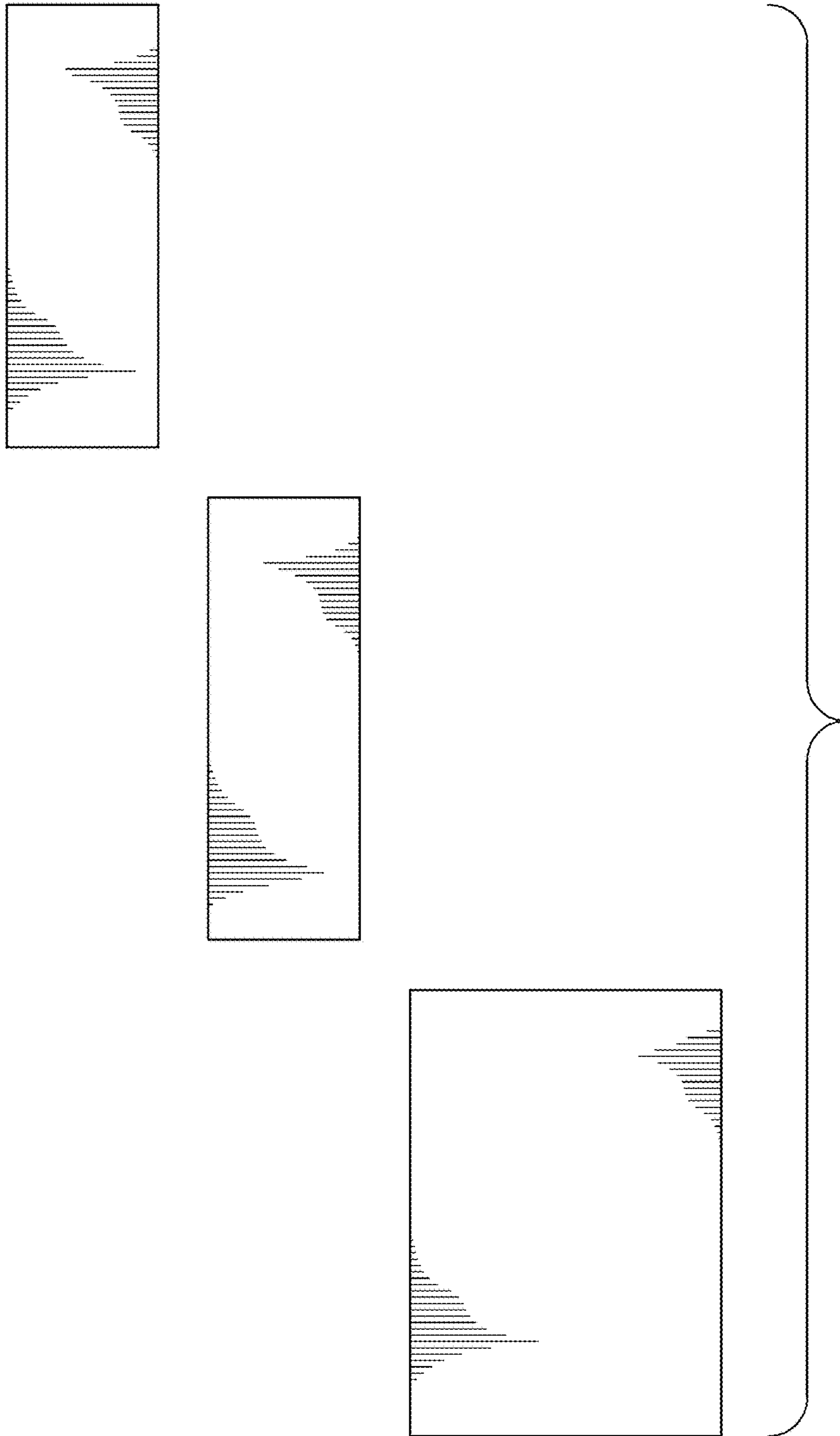

FIG. 7

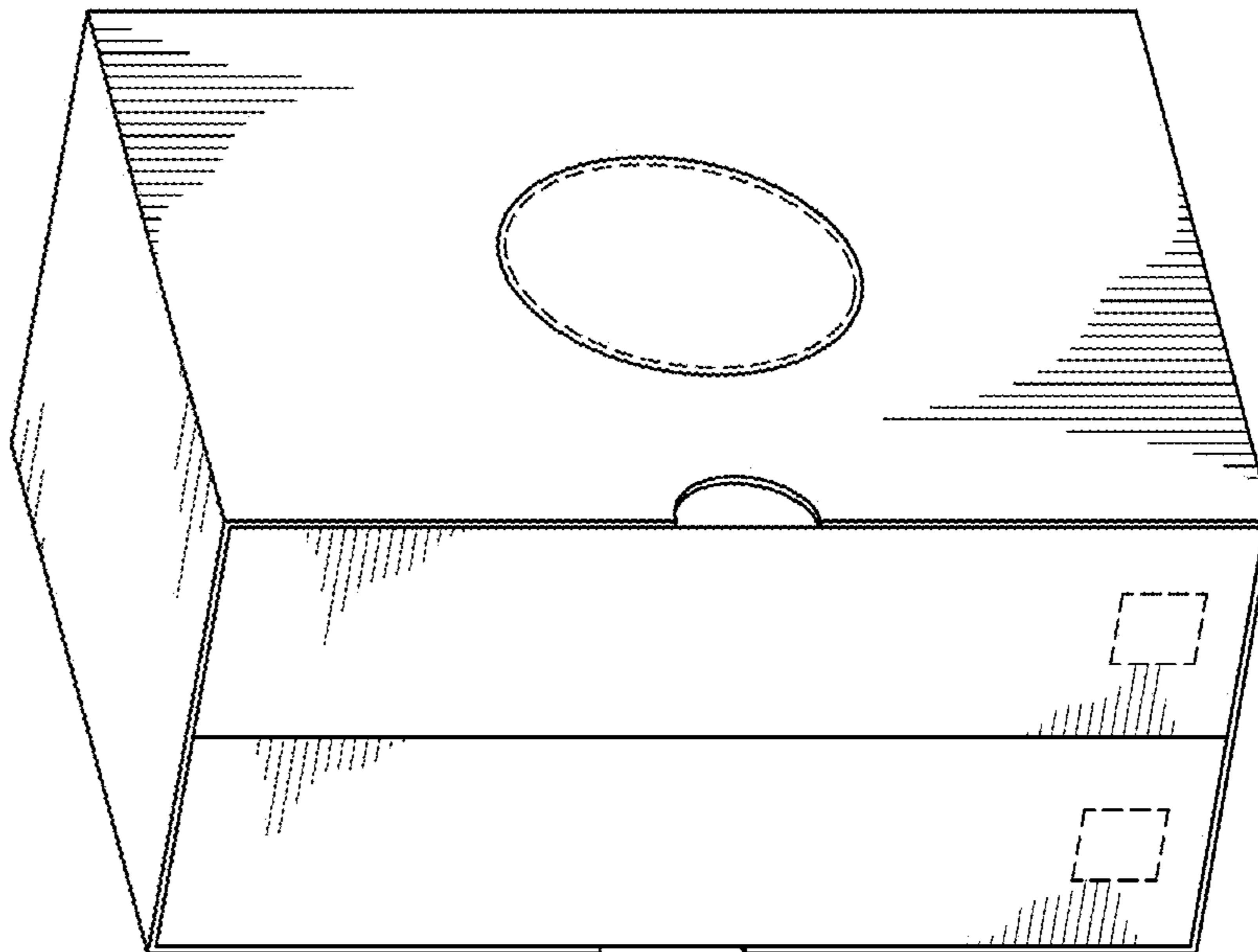

FIG. 8