



US00D782434S

(12) **United States Design Patent**
Kim et al.

(10) **Patent No.:** **US D782,434 S**
(45) **Date of Patent:** **** Mar. 28, 2017**

(54) **TELEVISION RECEIVER**

(71) Applicant: **Samsung Electronics Co., Ltd.**,
Suwon-si (KR)

(72) Inventors: **Eunah Kim**, Seoul (KR); **Sungil Bang**,
Seoul (KR)

(73) Assignee: **SAMSUNG ELECTRONICS CO.,
LTD.**, Suwon-si (KR)

(**) Term: **15 Years**

(21) Appl. No.: **29/556,795**

(22) Filed: **Mar. 3, 2016**

(30) **Foreign Application Priority Data**

Sep. 3, 2015 (KR) 30-2015-0044725

(51) **LOC (10) Cl.** **14-03**

(52) **U.S. Cl.**
USPC **D14/126**

(58) **Field of Classification Search**
USPC D14/125-134, 239, 371, 136, 374-377,
D14/440, 450, 448, 336, 342, 159;
312/7.2; 348/836, 838, 180, 184, 325,
348/739; 248/917-924, 465; 345/104,
345/133, 156, 168, 87, 173; D21/329,
D21/515, 577, 622, 333, 433, 448, 452,
D21/450, 331, 505; D10/15, 26;
446/484, 175, 356; D6/477, 479, 300;
D20/10, 19, 39; D16/203, 241; 160/24
CPC G06F 1/1601; G06F 1/1643; G06F 1/1652;
G06F 1/1647; G06F 3/0412; H05K
5/0004; H05K 5/0017; H05K 5/02; H05K
5/0217; H04N 13/0459

See application file for complete search history.

(56) **References Cited**

U.S. PATENT DOCUMENTS

D680,106 S *	4/2013	Hwangbo	D14/239
D700,187 S *	2/2014	Lee	D14/451
D716,244 S *	10/2014	Kim	D14/126
D719,119 S *	12/2014	Park	D14/126
D729,755 S *	5/2015	McManigal	D14/126
D734,282 S *	7/2015	Shin	D14/126
D735,153 S *	7/2015	Snyder	D14/126
D749,532 S *	2/2016	McManigal	D14/126
D751,519 S *	3/2016	Ma	D14/126
D765,615 S *	9/2016	Kim	D14/126

* cited by examiner

Primary Examiner — Raphael Barkai

(74) *Attorney, Agent, or Firm* — McAndrews Held &
Malloy, Ltd.

(57) **CLAIM**

The ornamental design for a television receiver, as shown
and described.

DESCRIPTION

FIG. 1 is a front perspective view of a television receiver
showing our new design;
FIG. 2 is a front elevation view thereof;
FIG. 3 is a rear elevation view thereof;
FIG. 4 is a left side elevation view thereof;
FIG. 5 is a right side elevation view thereof;
FIG. 6 is a top plan view thereof;
FIG. 7 is a bottom plan view thereof; and,
FIG. 8 is a rear perspective view thereof.
The dashed broken lines in the figures represent unclaimed
portions of the television receiver and form no part of the
claimed design.

1 Claim, 8 Drawing Sheets

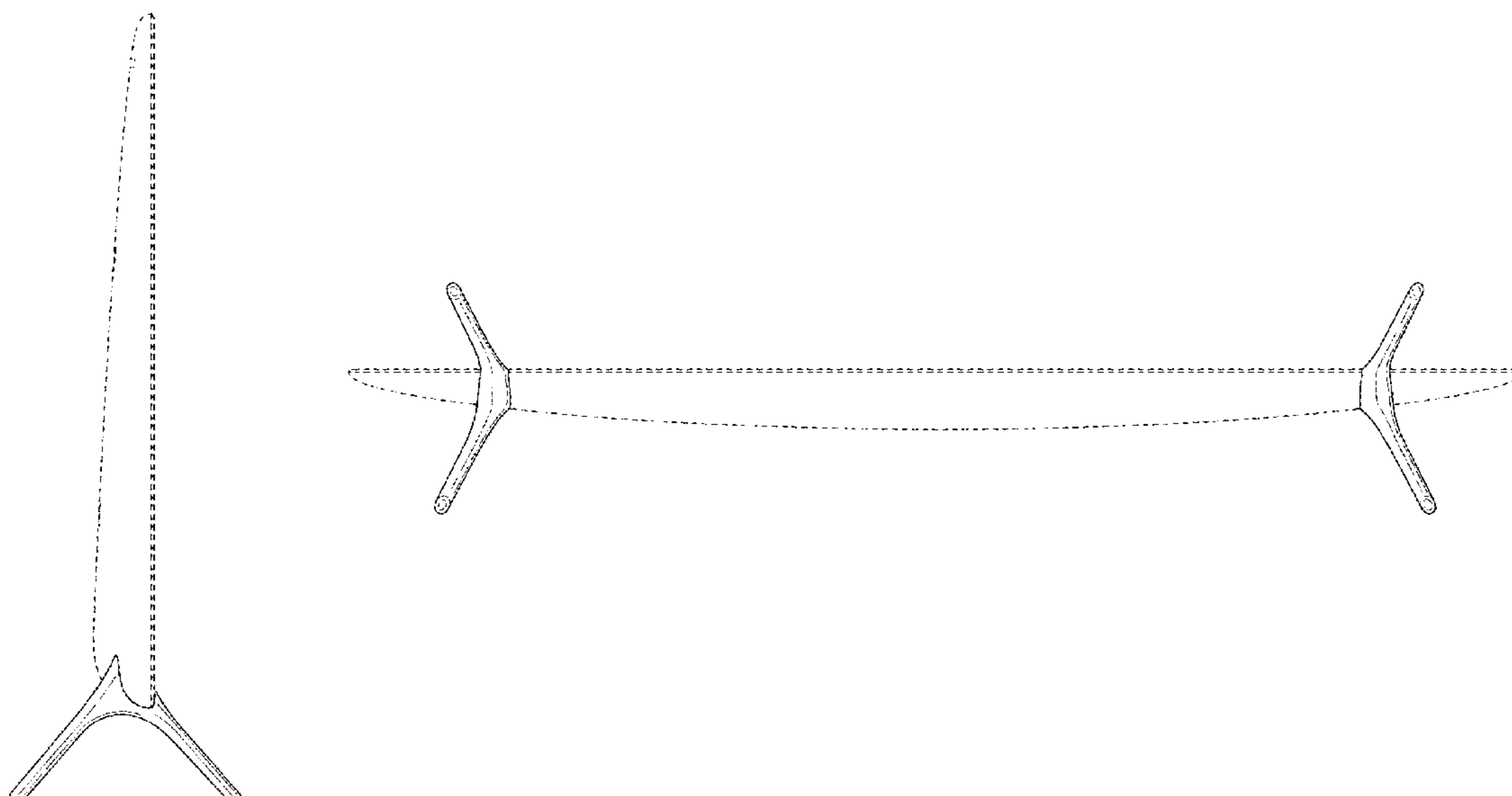

FIG. 1

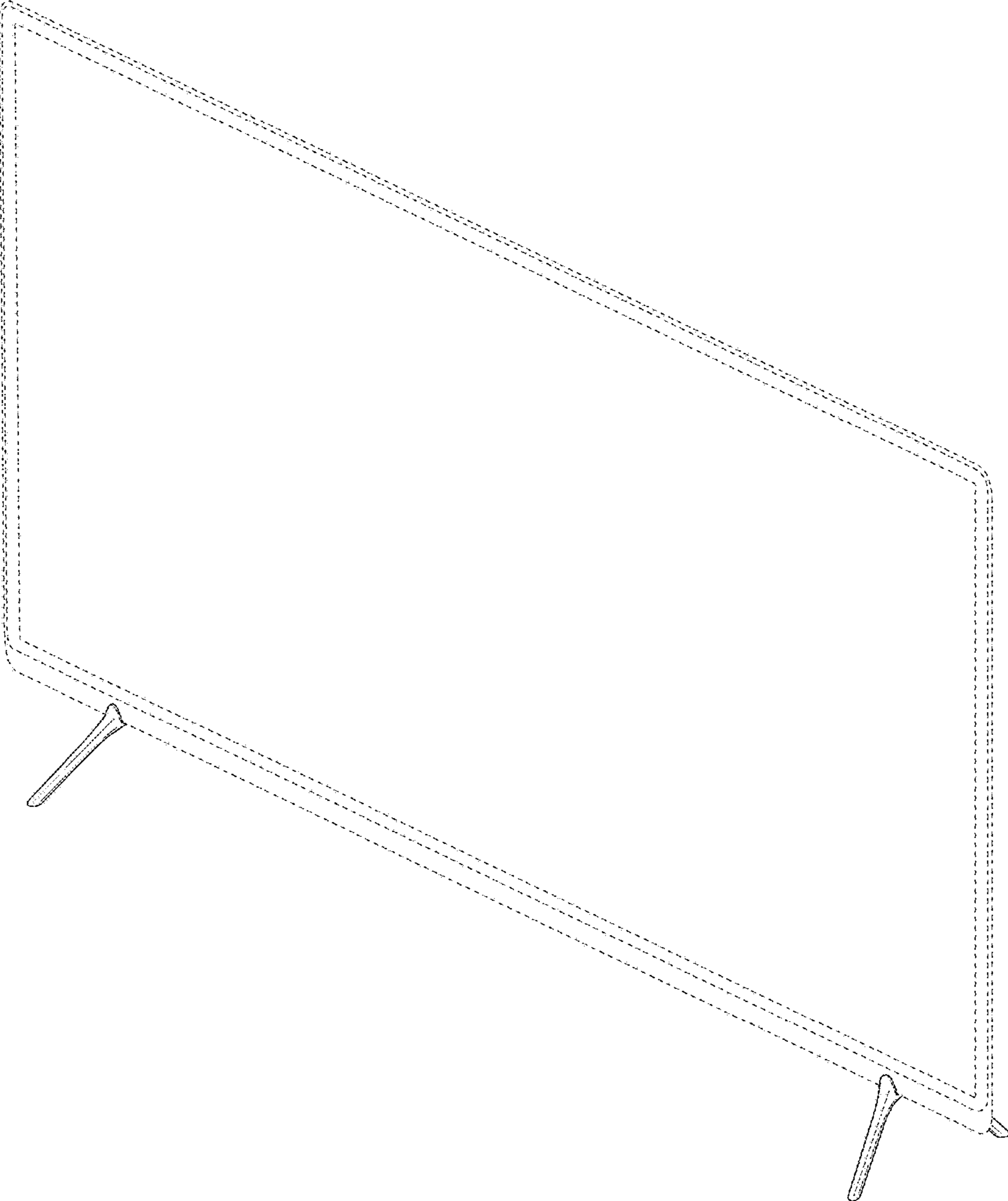

FIG. 2



FIG. 3

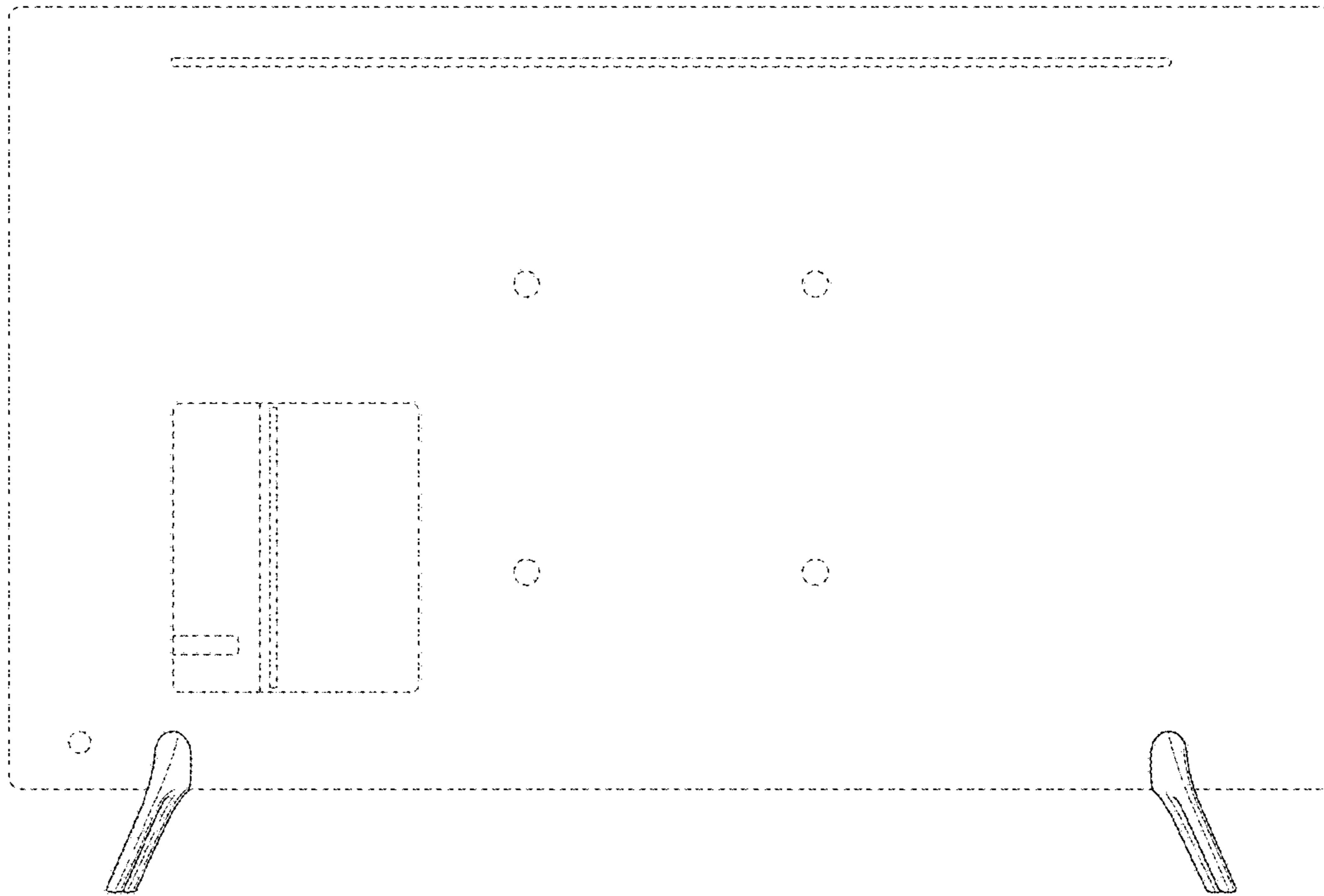

FIG. 4

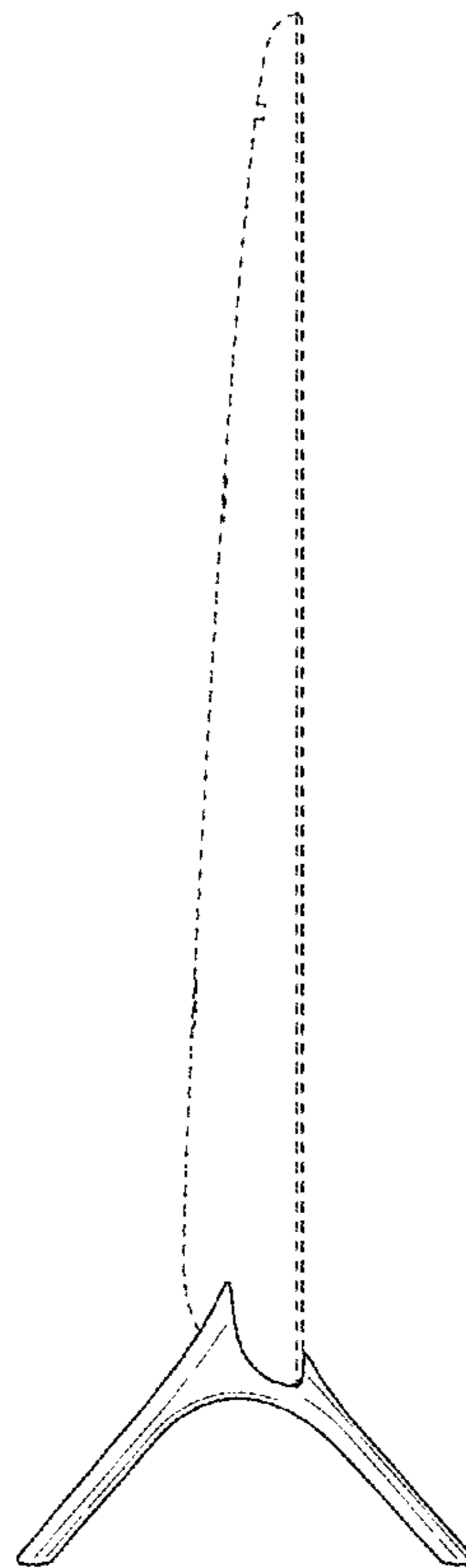

FIG. 5

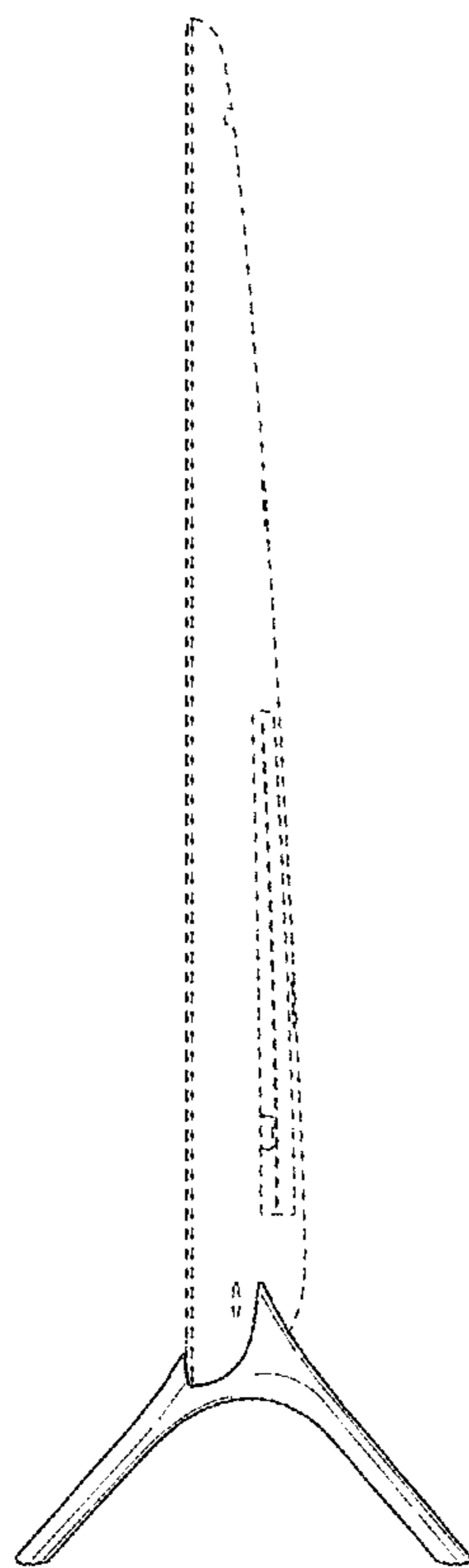

FIG. 6

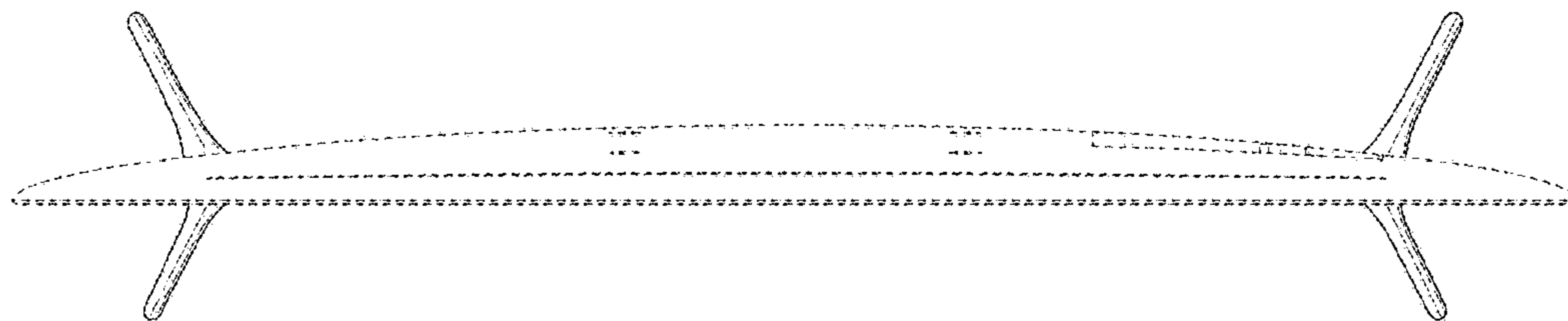

FIG. 7

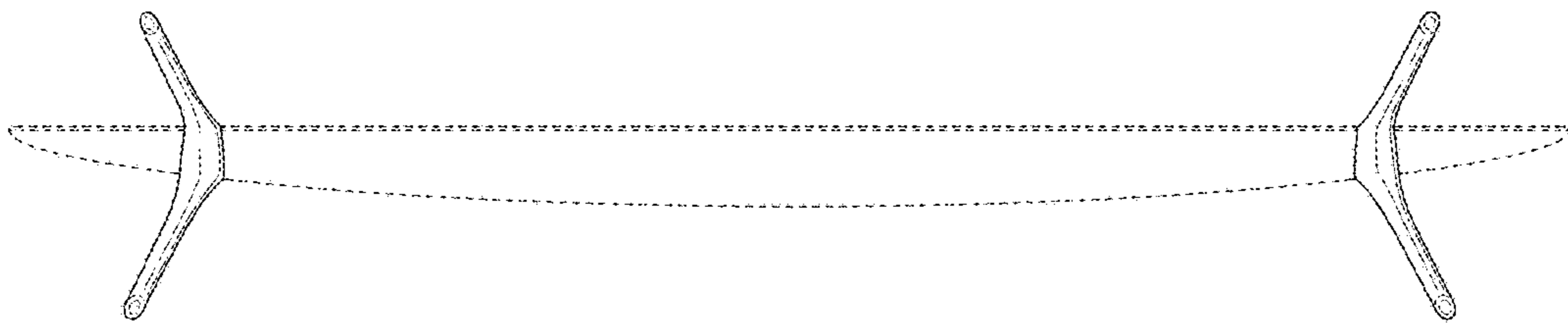

FIG. 8

