



US00D782153S

(12) **United States Design Patent** (10) **Patent No.:** **US D782,153 S**  
**Caliman** (45) **Date of Patent:** **\*\* Mar. 28, 2017**

- (54) **GLOVE WITH HOOVES**
- (71) Applicant: **Matthew Caliman**, Kings Park, NY  
(US)
- (72) Inventor: **Matthew Caliman**, Kings Park, NY  
(US)
- (\*\*) Term: **15 Years**
- (21) Appl. No.: **29/528,917**
- (22) Filed: **Jun. 2, 2015**
- (51) **LOC (10) Cl.** ..... **02-06**
- (52) **U.S. Cl.**  
USPC ..... **D2/616**
- (58) **Field of Classification Search**  
USPC ..... D2/611-618, 622, 889, 900; D21/416,  
D21/584, 614, 620; D29/117.1; 446/327  
CPC ..... A41D 19/00; A41D 19/01; A41D 19/04;  
A41D 19/0058; A41G 7/00; A63H 3/14;  
A63J 19/00; A63J 19/006  
See application file for complete search history.

- D734,406 S \* 7/2015 Jiencke ..... D21/620
- D742,600 S \* 11/2015 Mathews ..... D2/619
- D748,342 S \* 1/2016 Kaniaru ..... D2/617
- D749,792 S \* 2/2016 Visokey ..... D29/117.1
- D765,920 S \* 9/2016 Ko ..... D2/615
- 2013/0160721 A1\* 6/2013 Cain ..... A01K 29/00  
119/850

\* cited by examiner

*Primary Examiner* — Wan Laymon  
*Assistant Examiner* — Clint A Samuel  
(74) *Attorney, Agent, or Firm* — QuickPatents, LLC;  
Kevin Prince

(57) **CLAIM**

I claim the ornamental design for a glove with hooves, as shown and described.

**DESCRIPTION**

FIG. 1 is a perspective view of a glove with hooves, showing my new design;  
FIG. 2 is a right-side elevational view thereof;  
FIG. 3 is a left-side elevational view thereof;  
FIG. 4 is a front elevational view thereof;  
FIG. 5 is a rear elevational view thereof;  
FIG. 6 is a top plan view thereof; and,  
FIG. 7 is a bottom plan view thereof.  
The dot-dash broken lines showing a plush animal head and tail in the figures depict environmental matter and form no part of the claimed design. The remaining broken lines on FIGS. 3, 4 and 7 represent stitching, and are part of the claimed design.

**1 Claim, 5 Drawing Sheets**

(56) **References Cited**

U.S. PATENT DOCUMENTS

- 2,335,320 A \* 11/1943 Swietek ..... A41D 19/0013  
132/73
- D378,869 S \* 4/1997 Mikell ..... D2/615
- 6,061,830 A \* 5/2000 Geller ..... A41D 1/00  
2/159
- D466,662 S \* 12/2002 Lorkovic ..... D32/43
- D472,944 S \* 4/2003 Jacobs ..... D21/576
- D513,827 S \* 1/2006 Ward ..... D2/619
- D707,310 S \* 6/2014 Carlson ..... D21/620
- D719,302 S \* 12/2014 Ko ..... D2/615

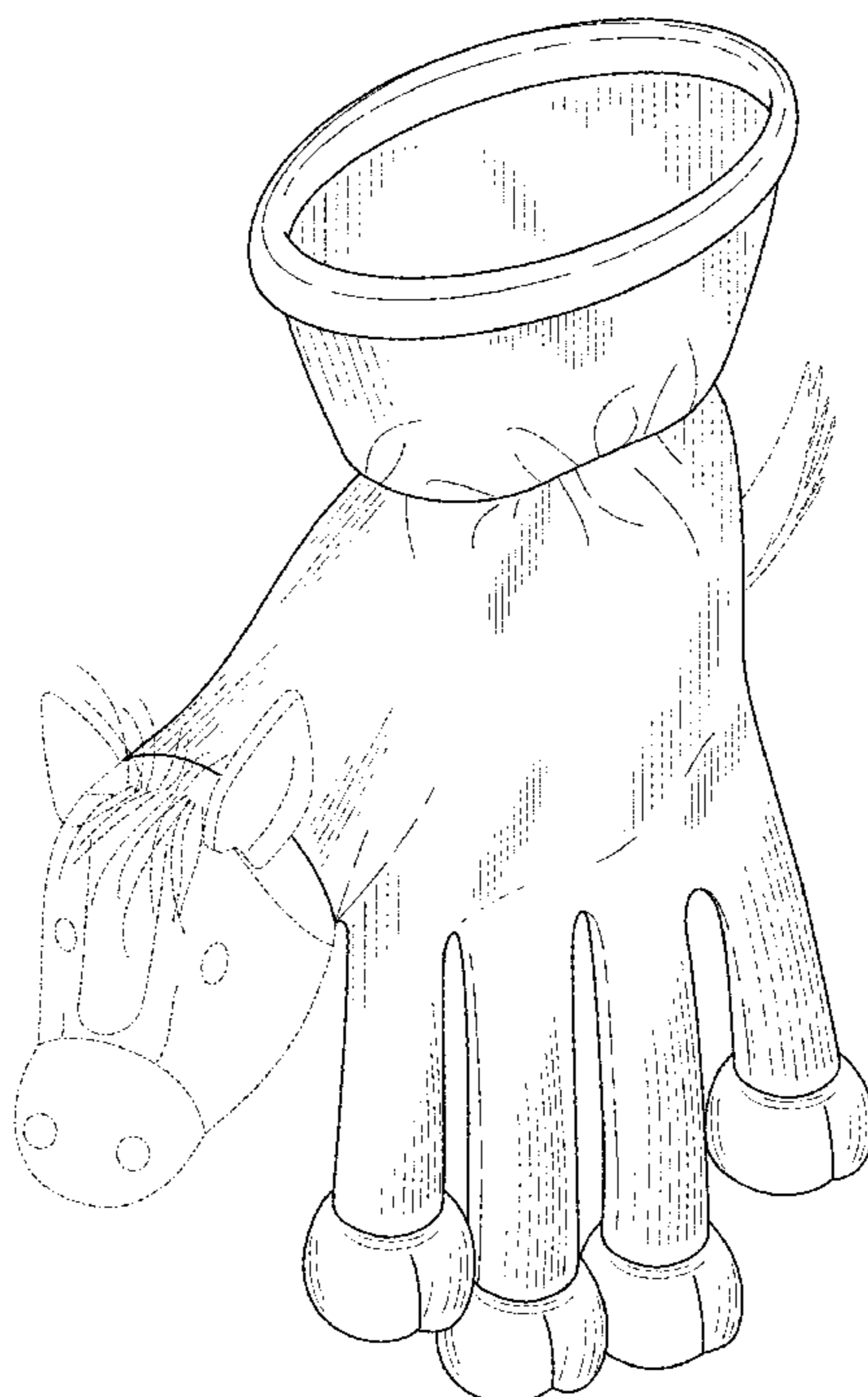

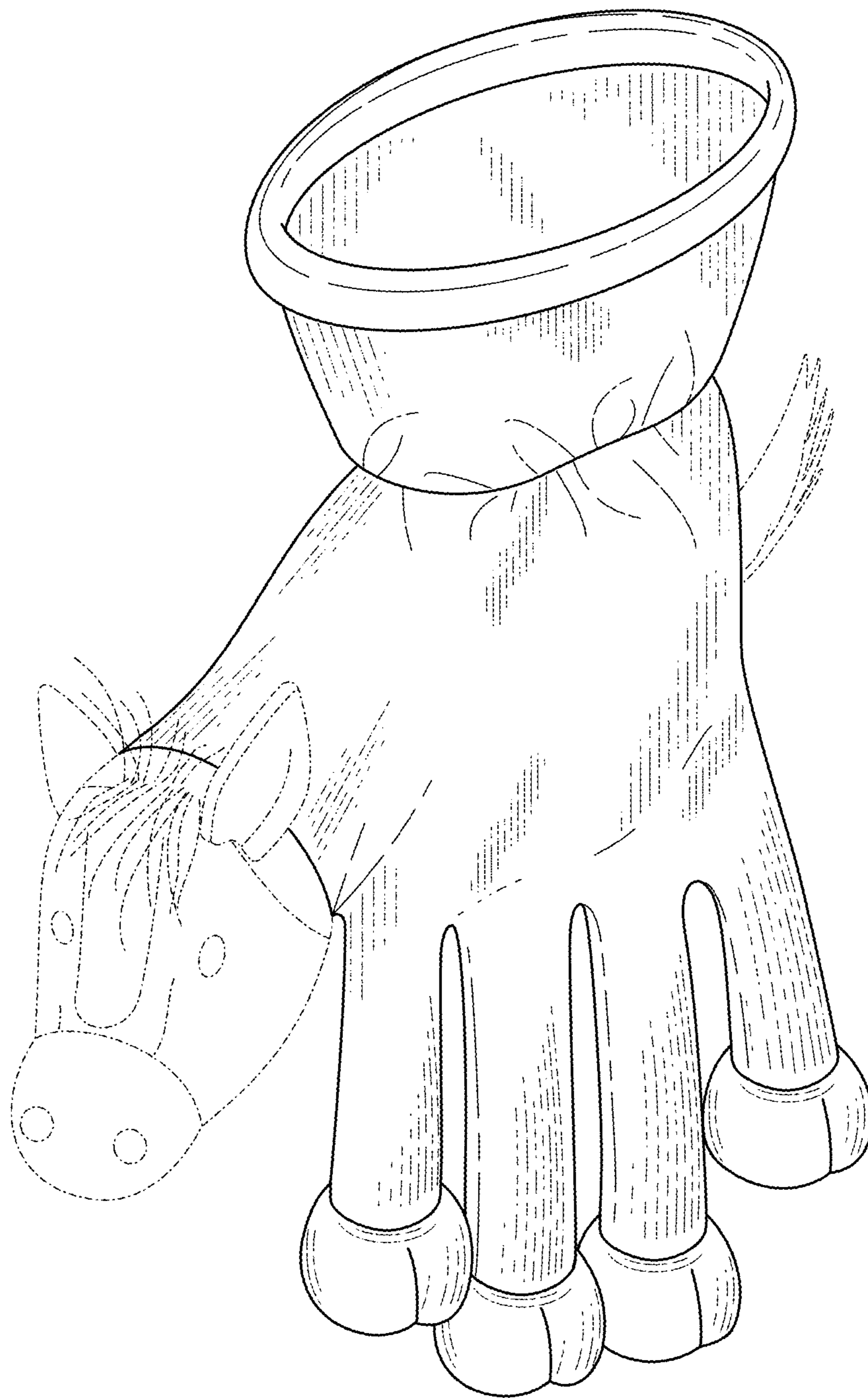

FIG. 1



FIG. 2

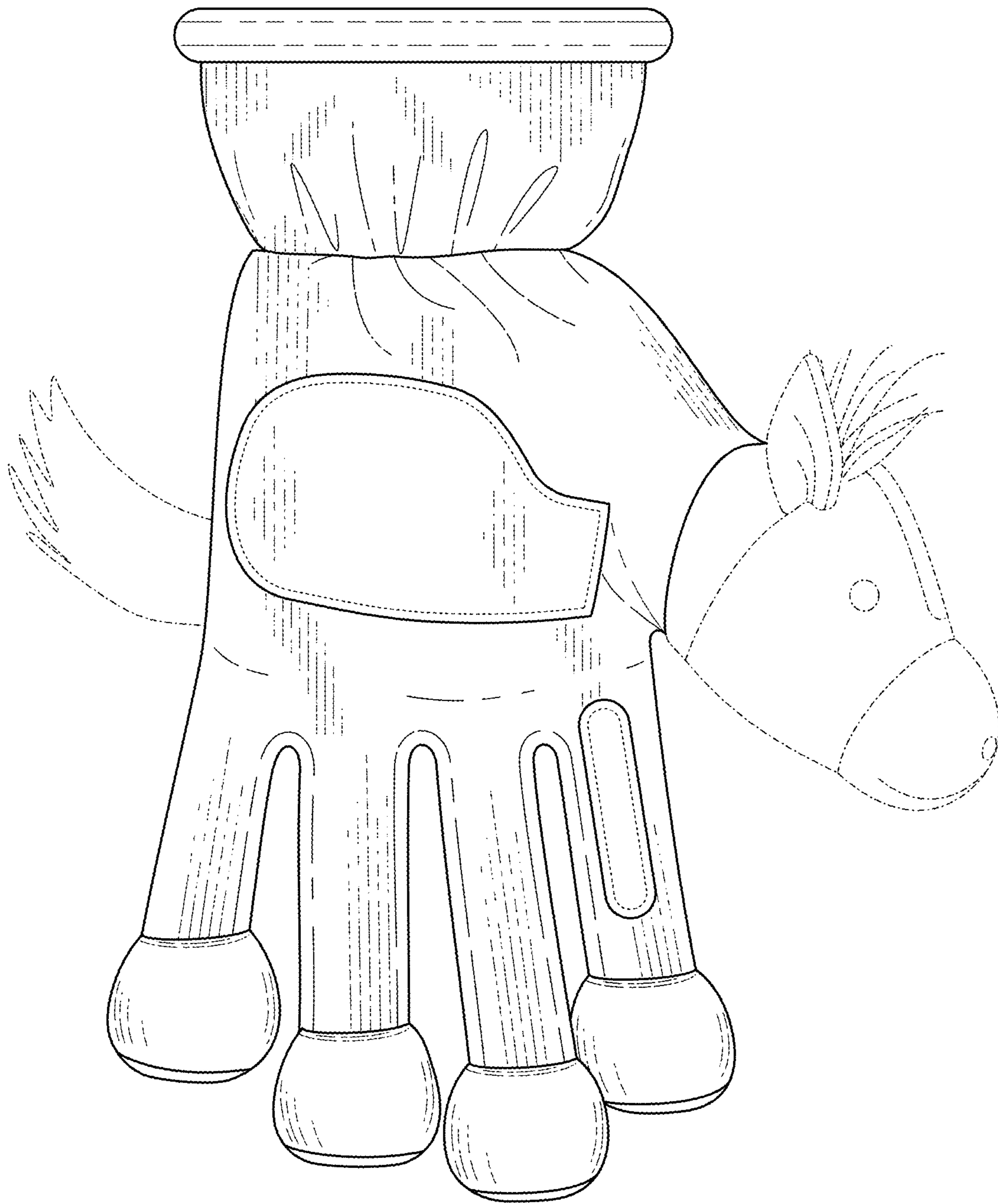

FIG. 3



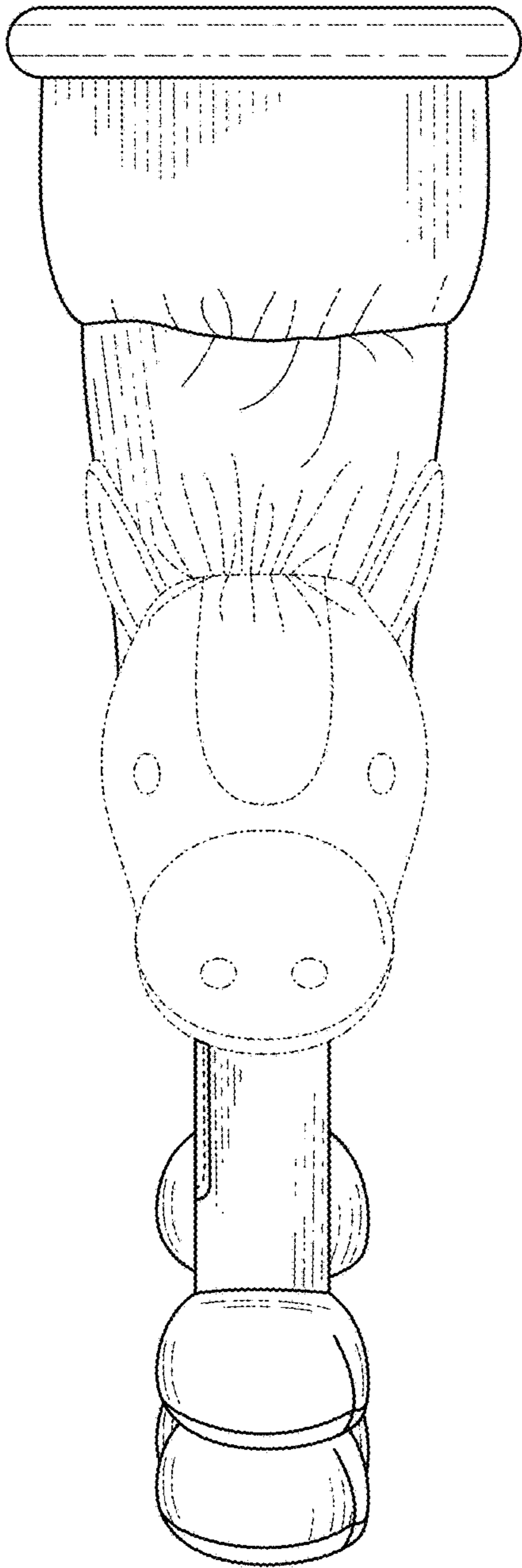

FIG. 4

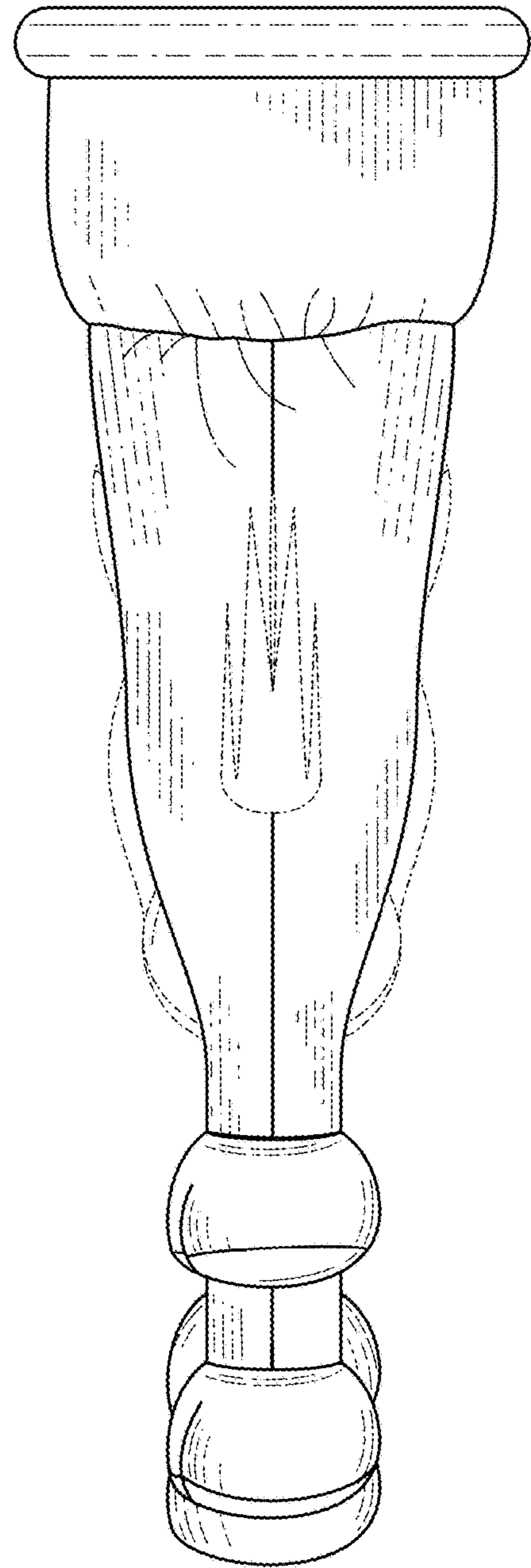

FIG. 5

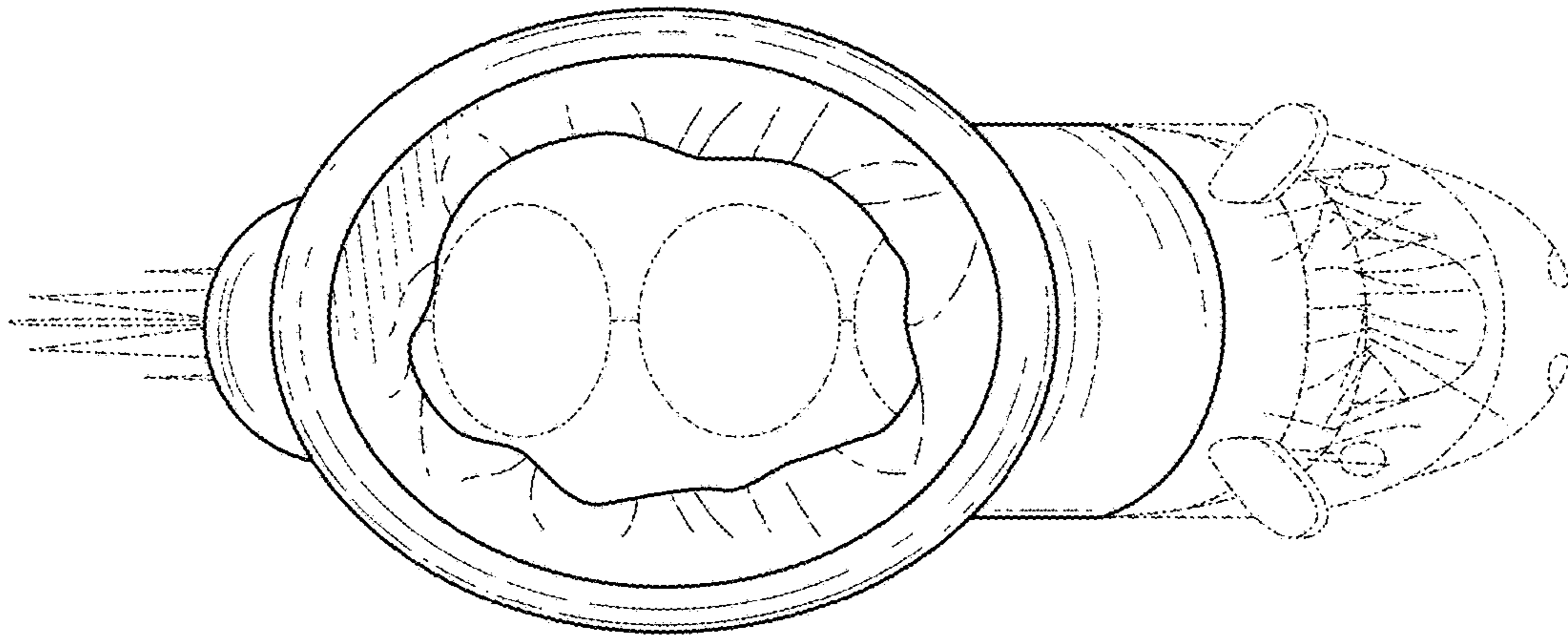

FIG. 6

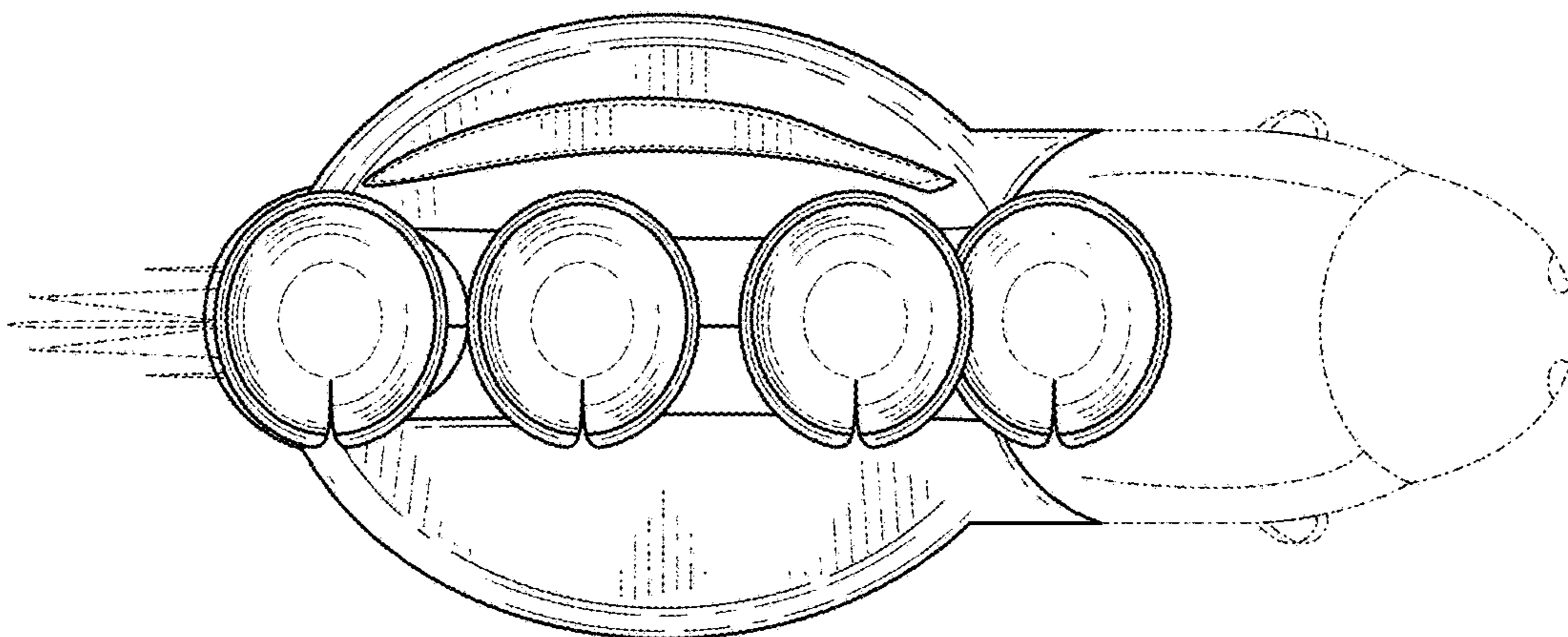

FIG. 7