



US00D782130S

(12) **United States Design Patent** (10) **Patent No.:** **US D782,130 S**
Javornick et al. (45) **Date of Patent:** **** Mar. 21, 2017**

(54) **PET COLLAR BUCKLE**
(71) Applicant: **Dig It, Inc.**, Carnegie, PA (US)
(72) Inventors: **Georgine Javornick**, Carnegie, PA (US); **David Aliberti**, Pittsburgh, PA (US)
(73) Assignee: **Dig It, Inc.**, Pittsburgh, PA (US)
(**) Term: **14 Years**

D579,819 S 11/2008 Brown
D579,820 S 11/2008 Brown
D619,928 S 7/2010 Bodino et al.
D628,515 S 12/2010 Schieble
D683,263 S 5/2013 Paik et al.
D703,097 S 4/2014 Nanbu et al.
D710,251 S * 8/2014 Mariner D11/234
D714,683 S 10/2014 McEntyre et al.
D719,485 S 12/2014 Kung
D750,850 S * 3/2016 Javornick D11/218
D755,076 S * 5/2016 Blocker D11/231

(Continued)

(21) Appl. No.: **29/523,761**
(22) Filed: **Apr. 14, 2015**
(51) **LOC (10) Cl.** **30-04**
(52) **U.S. Cl.**
USPC **D30/152; D11/231**
(58) **Field of Classification Search**
USPC D30/139, 144, 145, 151, 152, 155, 199;
D2/627, 635, 638, 894; D29/100, 101.1,
D29/101.2, 101.5; D11/3, 231; D24/190
CPC A01K 27/001
See application file for complete search history.

OTHER PUBLICATIONS

“Kalan Full Grain Leather Belt 1 ¾" Wide”. Found on Dec. 1, 2016 at belts.com. Page dated Feb. 9, 2014. Retrieved from <https://web.archive.org/web/20140209180933/http://belts.com/kalevilebe13.html>.*

(Continued)

Primary Examiner — Robert M Spear
Assistant Examiner — Kendra L Hamilton
(74) *Attorney, Agent, or Firm* — McKay & Associates, P.C.

(56) **References Cited**

(57) **CLAIM**

U.S. PATENT DOCUMENTS

The ornamental design for a pet collar buckle, as shown.

D45,603 S * 4/1914 Reynolds D11/231
1,987,469 A * 1/1935 Devendor A44B 11/001
24/101 R
D130,445 S * 11/1941 Kaben D11/231
2,698,980 A * 1/1955 White A44B 11/001
24/194
D259,152 S * 5/1981 Heuser D11/230
D297,776 S * 9/1988 Bridges D30/152
D347,197 S 5/1994 Greene
6,748,903 B1 * 6/2004 Price, III A01K 27/006
119/858
D503,997 S * 4/2005 Sanchez, Jr. D30/152
D556,634 S 12/2007 Koroluk
D571,550 S * 6/2008 Valle D2/946

DESCRIPTION

FIG. 1 is a perspective view of a pet collar buckle, showing my new design;
FIG. 2 is a top plan view thereof;
FIG. 3 is a bottom plan view thereof;
FIG. 4 is a rear elevation view thereof;
FIG. 5 is a front elevation view thereof;
FIG. 6 is a left side view thereof; and,
FIG. 7 is a right side view thereof.

1 Claim, 2 Drawing Sheets

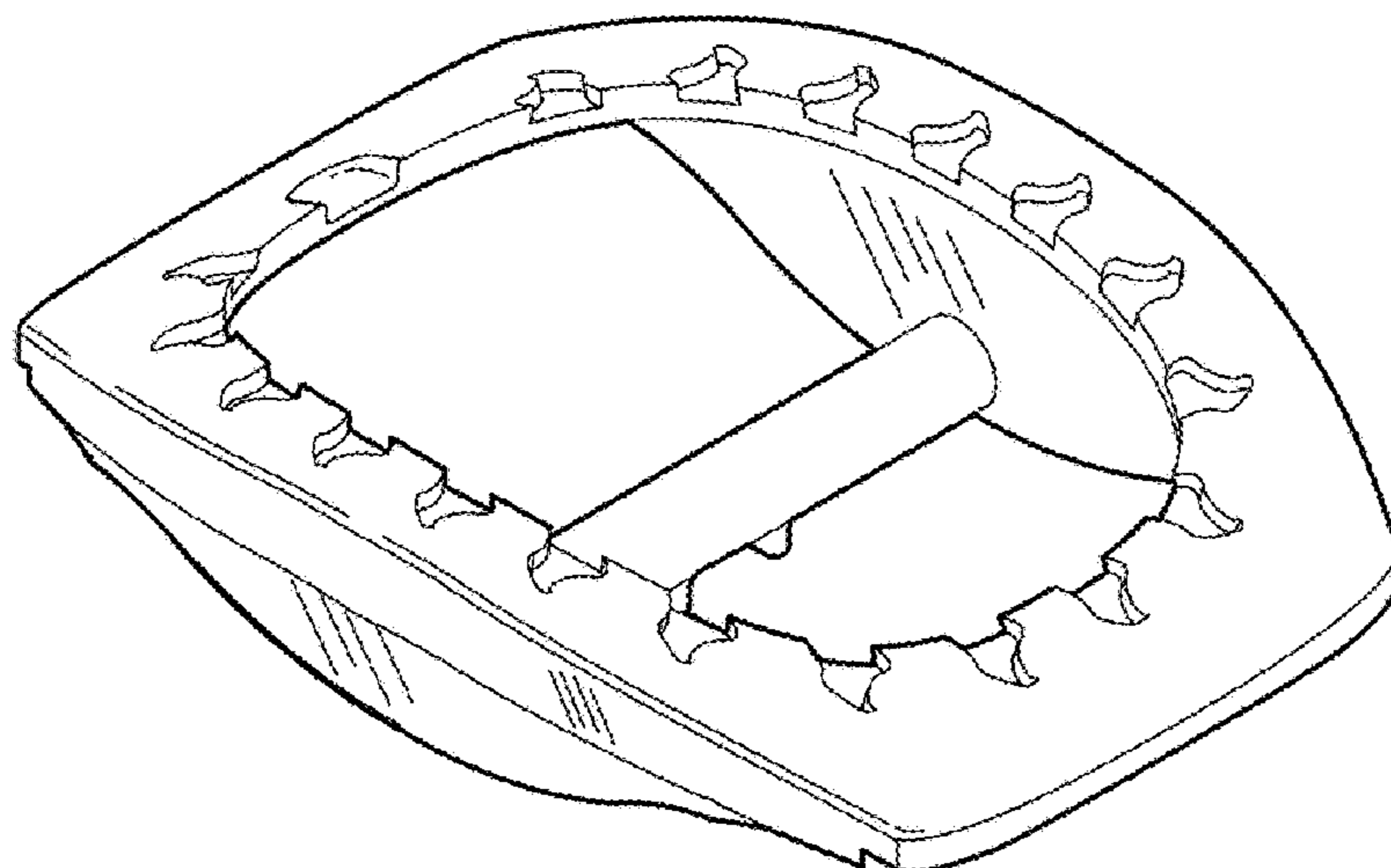

(56)

References Cited

U.S. PATENT DOCUMENTS

2008/0229551 A1* 9/2008 Bell A01K 27/00
24/188

OTHER PUBLICATIONS

“Fancy Decorative Clasp Fashion Style Buckle for Purse”. Found on Dec. 1, 2016 at sell.lulusoso.com. Page dated Jun. 26, 2012. Retrieved from <http://sell.lulusoso.com/selling-leads/2402278/fancy-decorative-clasp-fashion-style-plastic-buckle-for-purse-shoes-garment-accessories.html>.*

“Black Basketweave 2.5" Tapered Belt”. Found online Dec. 1, 2016 at belts.com. Page dated Aug. 11, 2013. Retrieved from <https://web.archive.org/web/20130811093607/http://belts.com/blba.html>.*

“Western Tooled Full Grain Leather Belt”. Found online Dec. 2, 2016 at belts.com. Page dated Aug. 12, 2013. Retrieved from <https://web.archive.org/web/20130812215755/http://belts.com/sfwetofugrle.html>.*

* cited by examiner

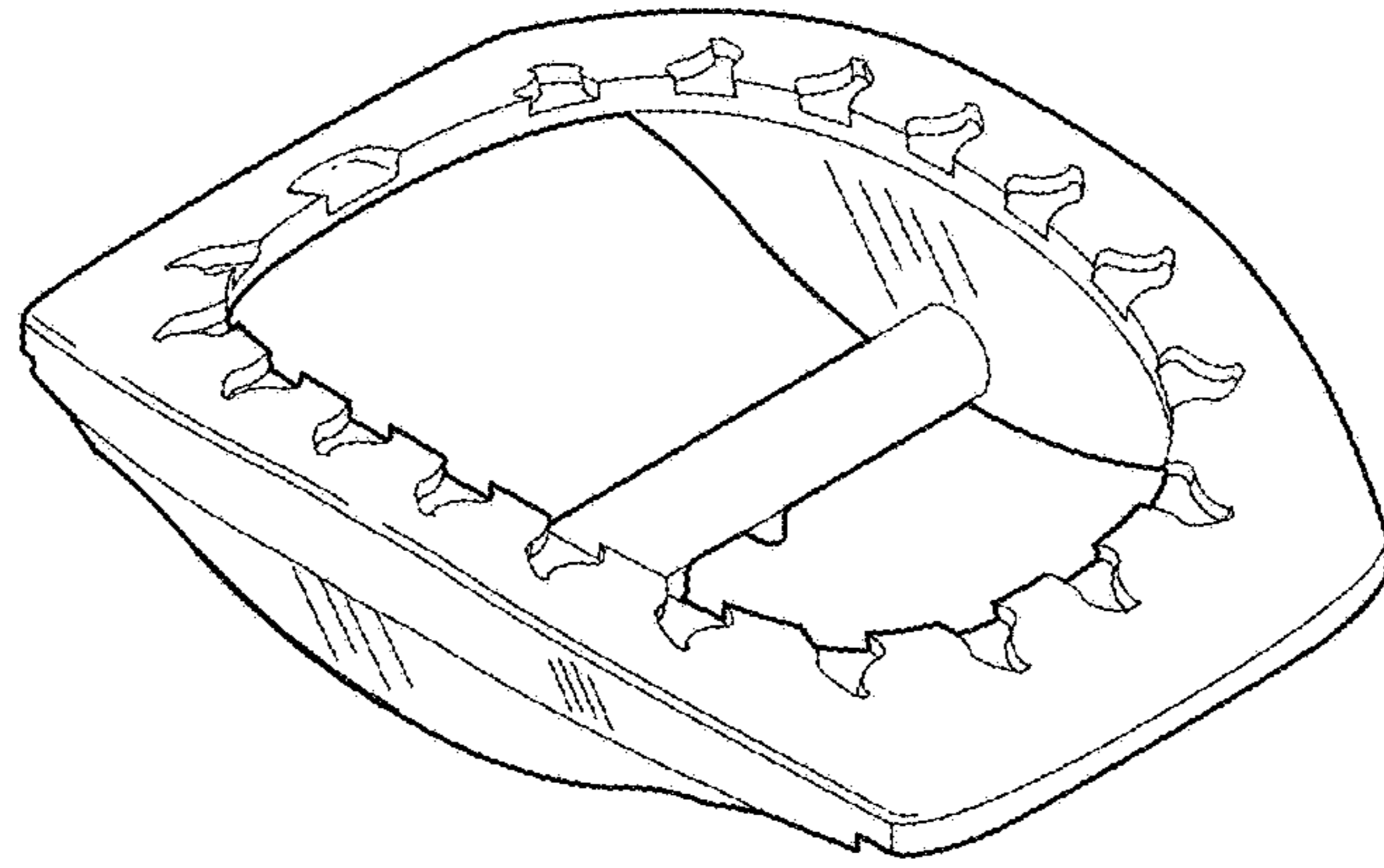

FIG. 1

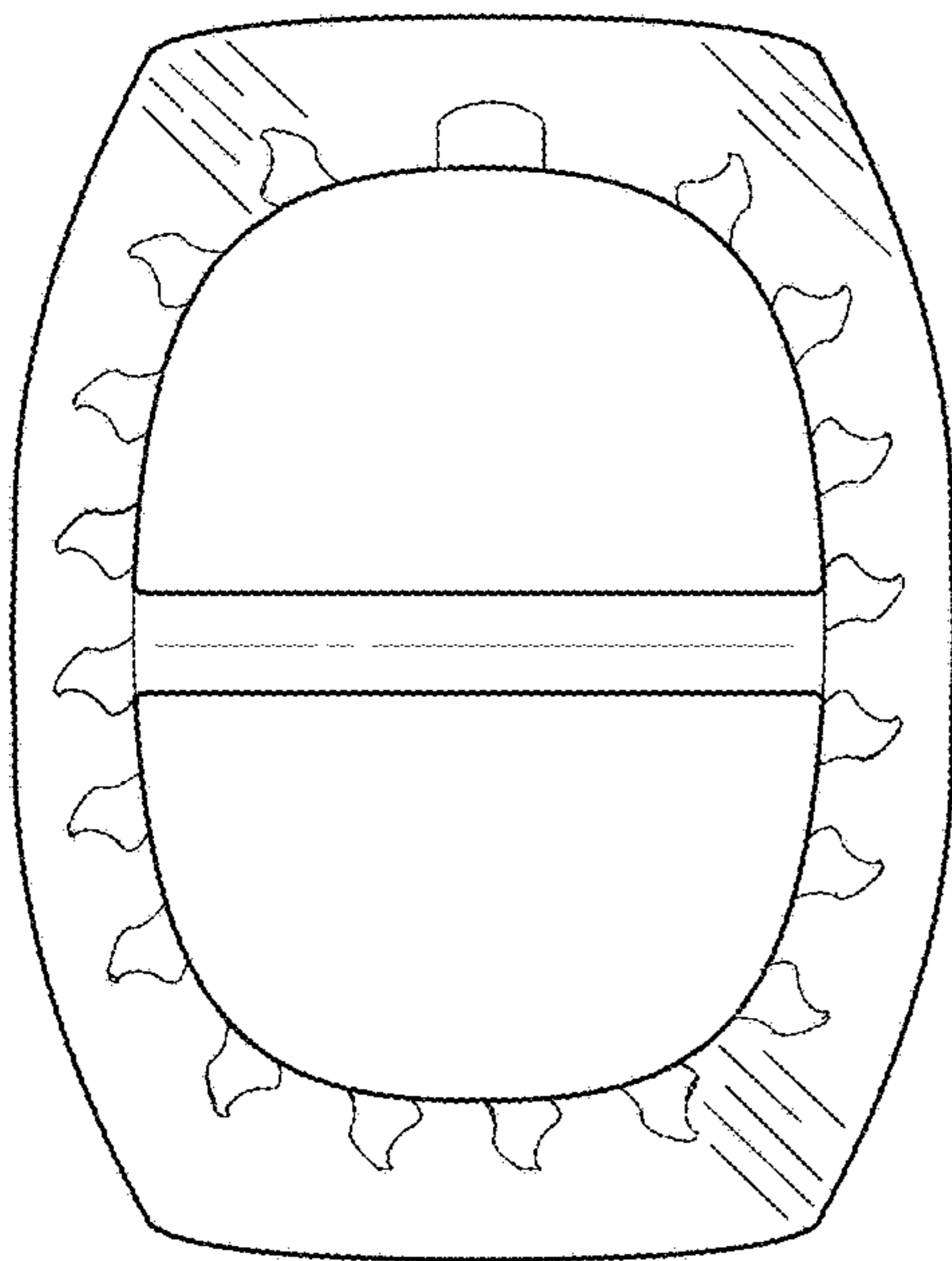

FIG. 2

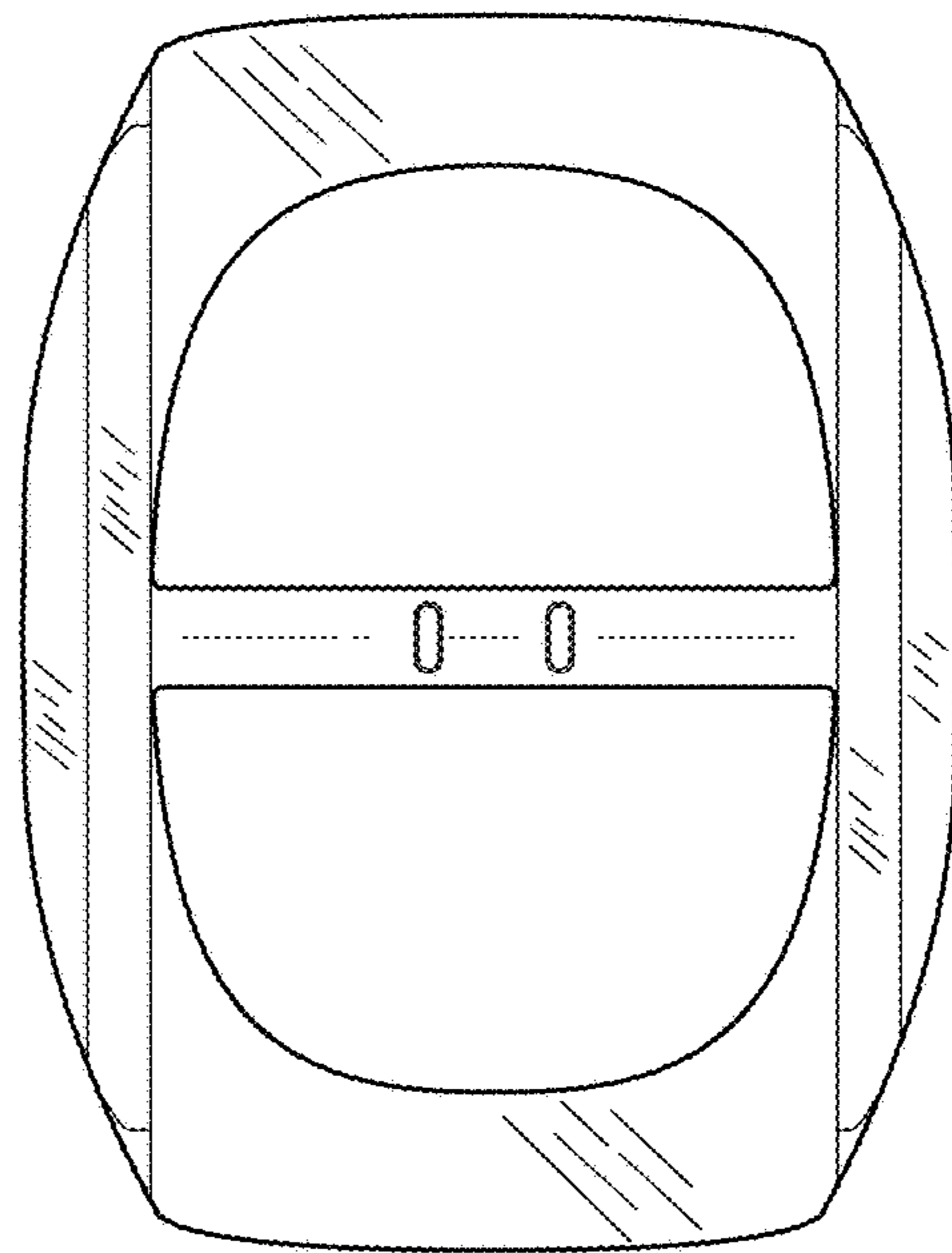

FIG. 3

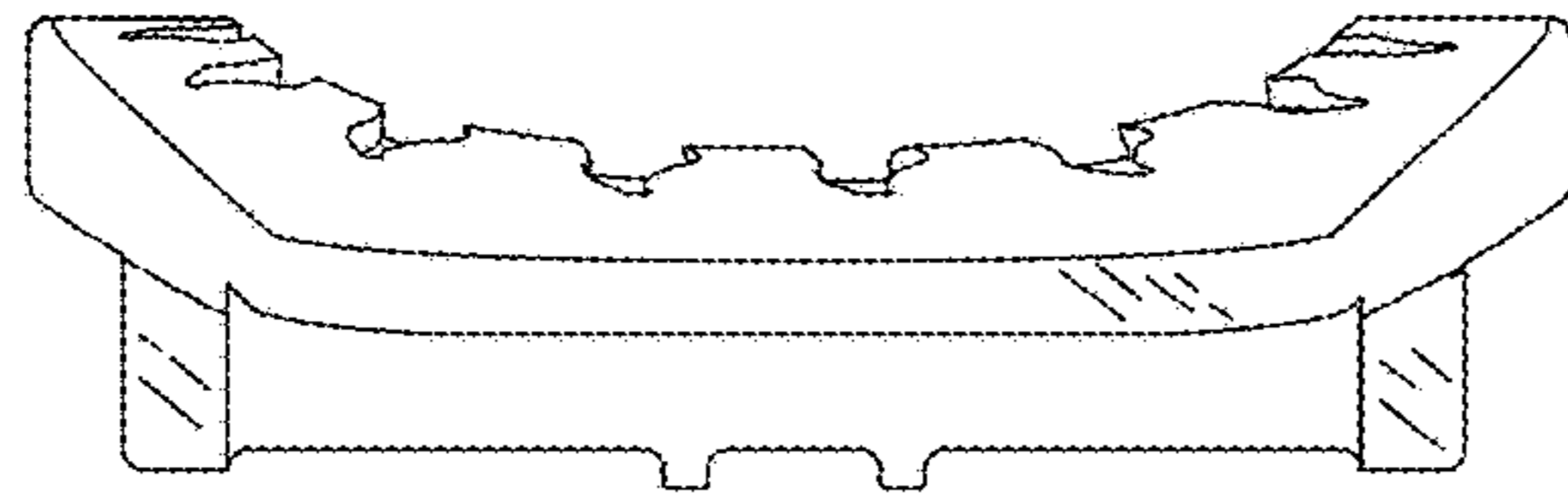

FIG. 4

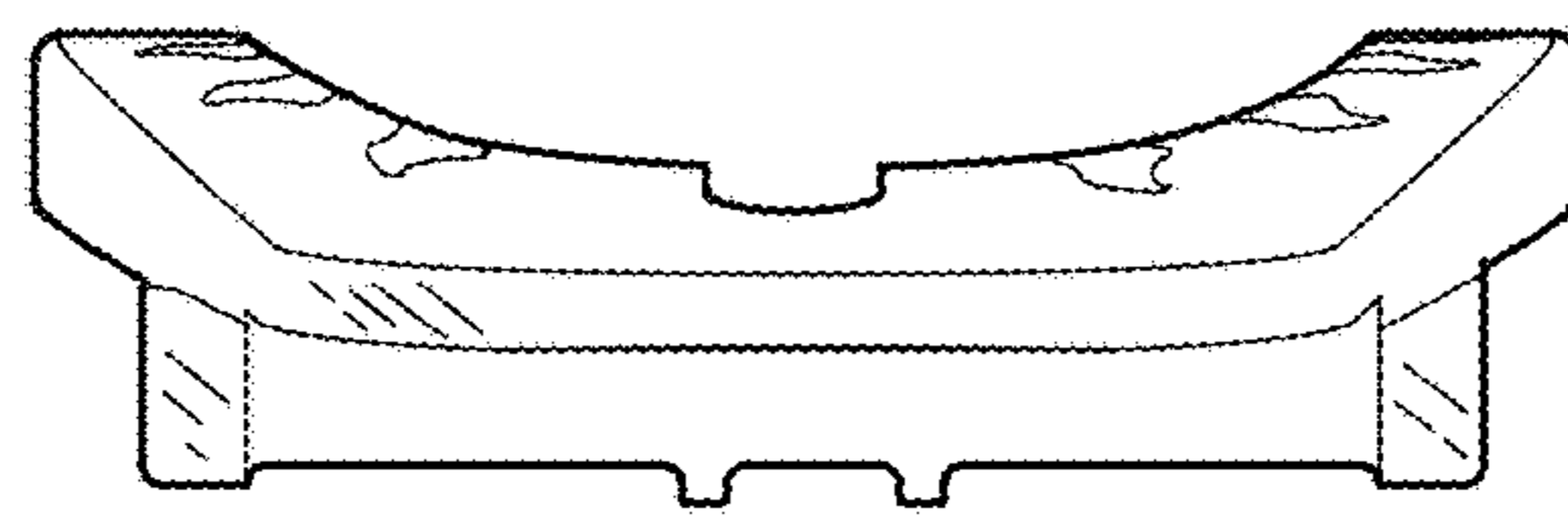

FIG. 5

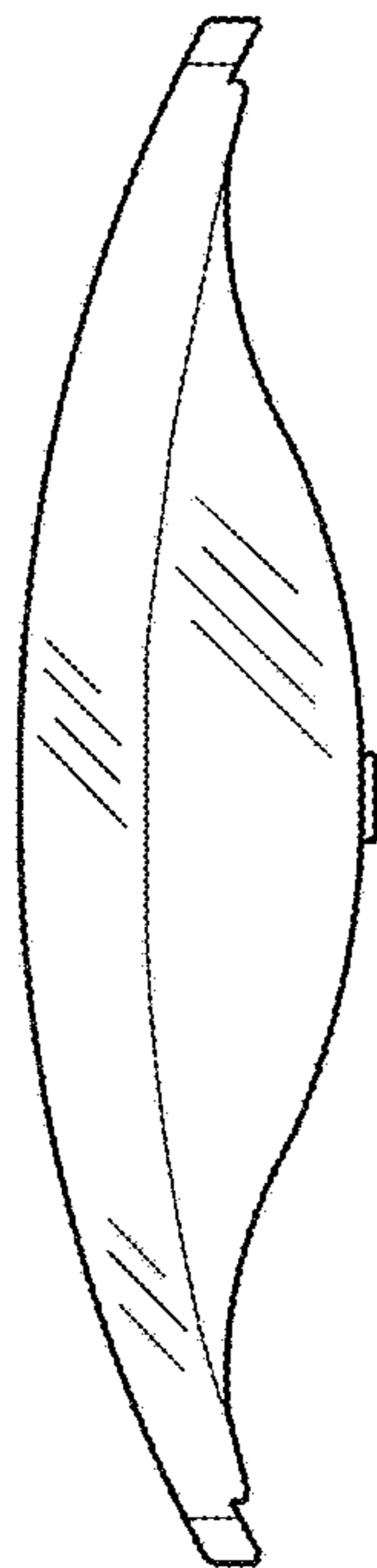

FIG. 6

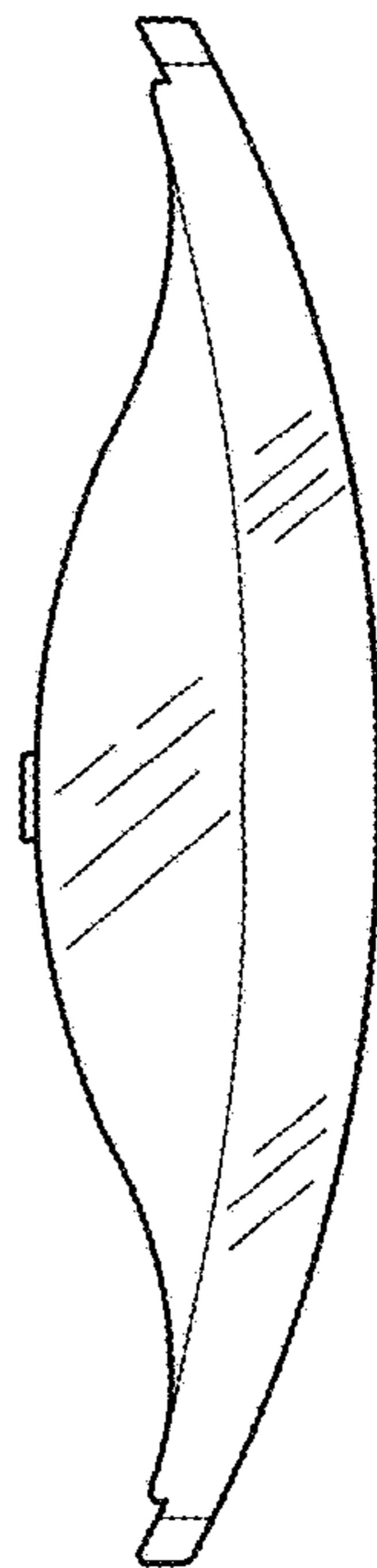

FIG. 7