

US00D782088S

(12) **United States Design Patent** (10) **Patent No.:** **US D782,088 S**
Honda (45) **Date of Patent:** **** Mar. 21, 2017**

- (54) **FRONT COMBINATION LAMP FOR AN AUTOMOBILE**
- (71) Applicant: **Nobuhiko Honda**, Nisshin (JP)
- (72) Inventor: **Nobuhiko Honda**, Nisshin (JP)
- (73) Assignee: **Toyota Jidosha Kabushiki Kaisha** (JP)
- (**) Term: **15 Years**
- (21) Appl. No.: **29/553,353**
- (22) Filed: **Feb. 1, 2016**
- (51) **LOC (10) Cl.** **26-06**
- (52) **U.S. Cl.**
USPC **D26/28**
- (58) **Field of Classification Search**
USPC D26/28-36; 362/80-83, 267-269,
362/459-468, 475-478, 485-487
CPC F21S 48/00; F21S 48/10; F21S 48/115;
F21S 48/225; F21S 48/1233; F21S
48/1266; F21S 48/1388; F21S 48/2268;
F21V 21/04
See application file for complete search history.

(56) **References Cited**

U.S. PATENT DOCUMENTS

D528,685 S	*	9/2006	Yoshida	D26/28
D544,114 S	*	6/2007	Ohta	D26/28
D560,291 S	*	1/2008	Koyama	D26/28
D561,358 S	*	2/2008	Tachibana	D26/28
D597,232 S	*	7/2009	Hanaoka	D26/28
D726,941 S	*	4/2015	Kato	D26/28
D728,133 S	*	4/2015	Bieling	D26/28

OTHER PUBLICATIONS

Toyota, Toyota Corolla (2014), netcarshow.com <<http://www.netcarshow.com/toyota/2014-corolla/>>, available at least as early as Apr. 20, 2015.
Mazda, Mazda 6 (2016), netcarshow.com <<http://www.netcarshow.com/mazda/2016-6/>>, available at least as early as Apr. 20, 2015.
Audi, Audi A1 (2015), netcarshow.com <<http://www.netcarshow.com/audi/2015-a1/>>, available at least as early as Apr. 20, 2015.

* cited by examiner

Primary Examiner — Marcus Jackson
(74) *Attorney, Agent, or Firm* — Saidman DesignLaw Group, LLC

(57) **CLAIM**

The ornamental design for a front combination lamp for an automobile, as shown and described.

DESCRIPTION

FIG. 1 is a perspective view of a front combination lamp for an automobile showing my new design;
FIG. 2 is a front view thereof;
FIG. 3 is a rear view thereof;
FIG. 4 is a top view thereof;
FIG. 5 is a bottom view thereof;
FIG. 6 is a left side view thereof; and,
FIG. 7 is a right side view thereof.
The claimed design is indicated by the relatively dark portions in the figures. The relatively light portions form no part of the claimed design.

1 Claim, 5 Drawing Sheets

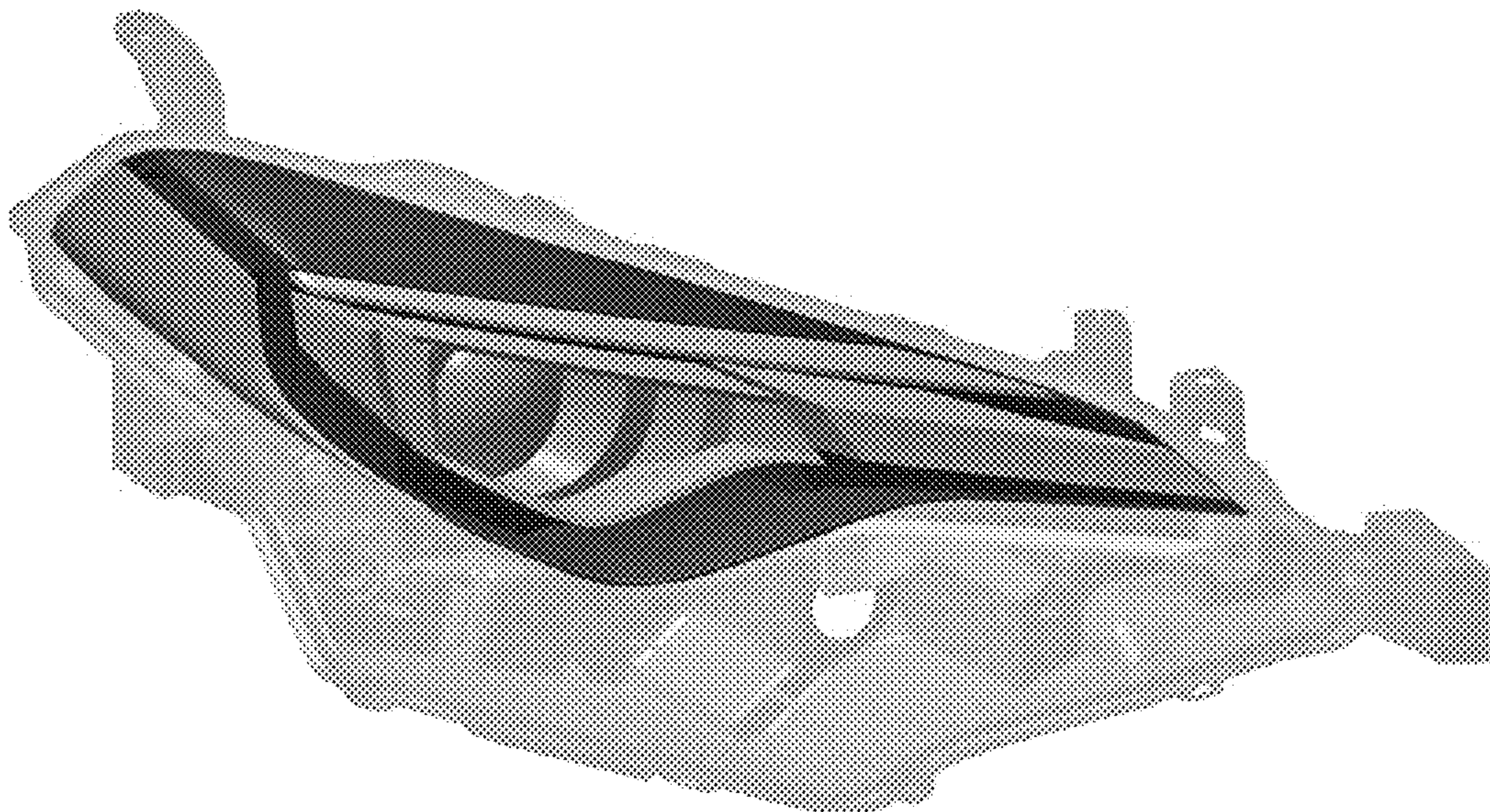

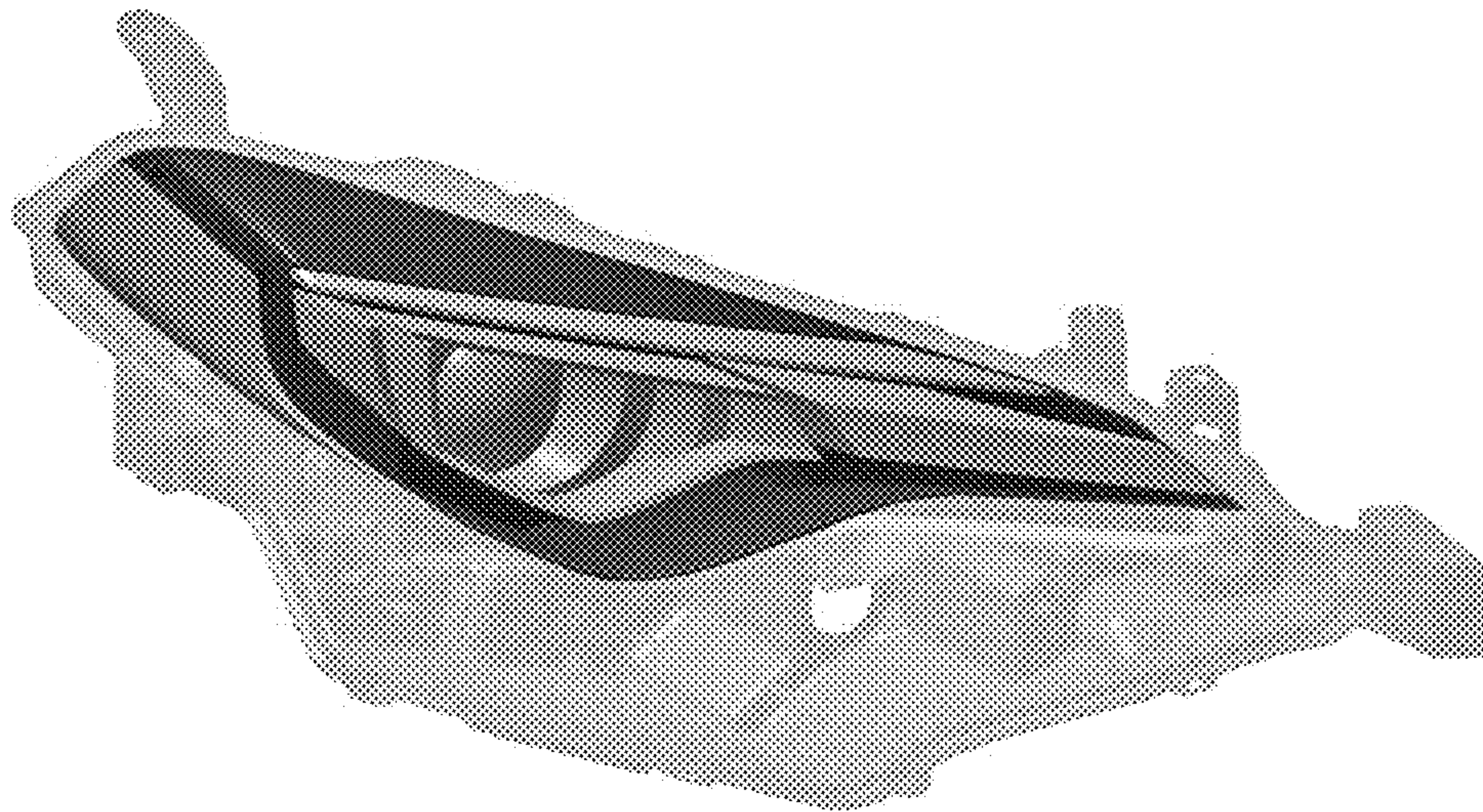

Fig. 1

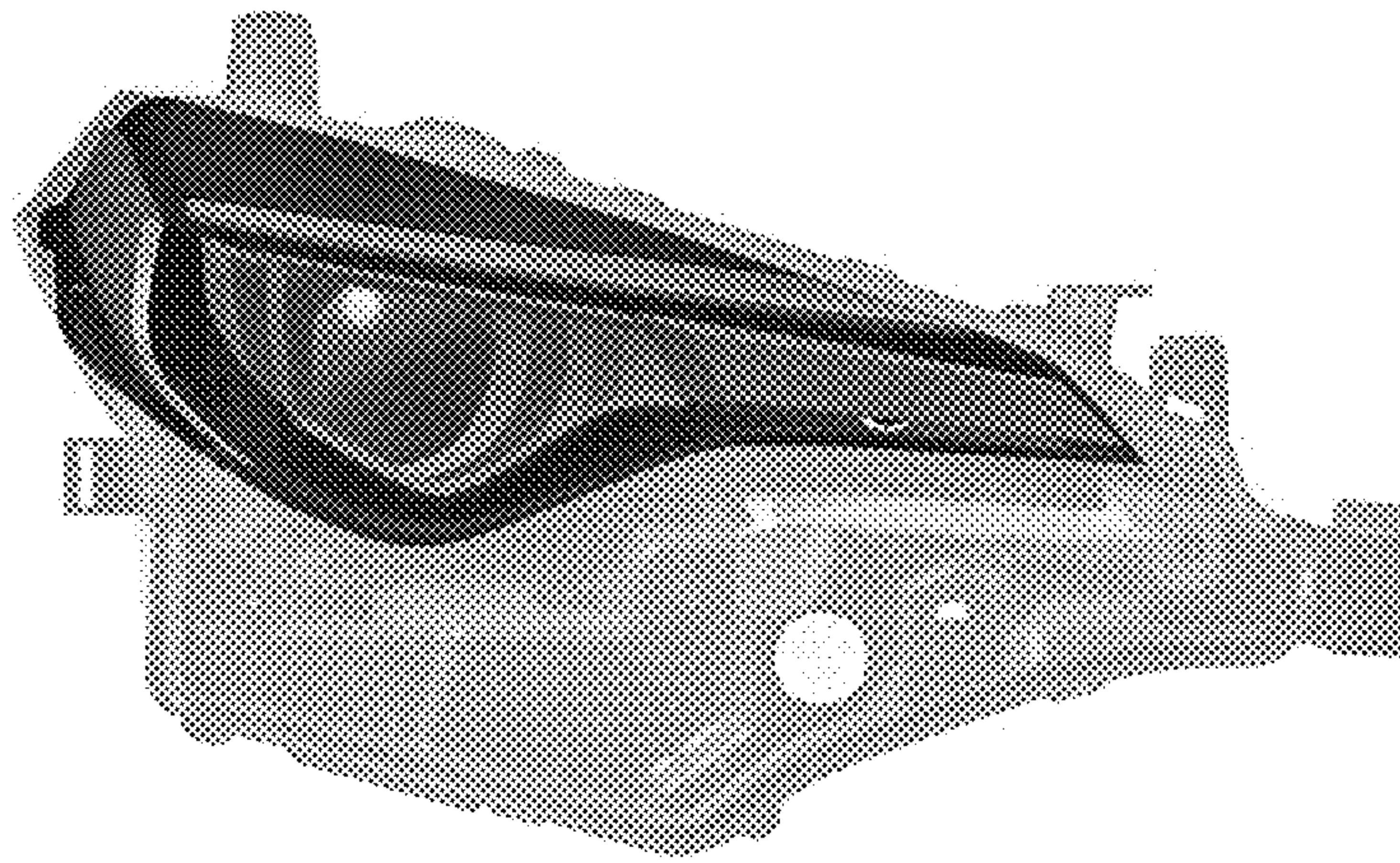

Fig. 2

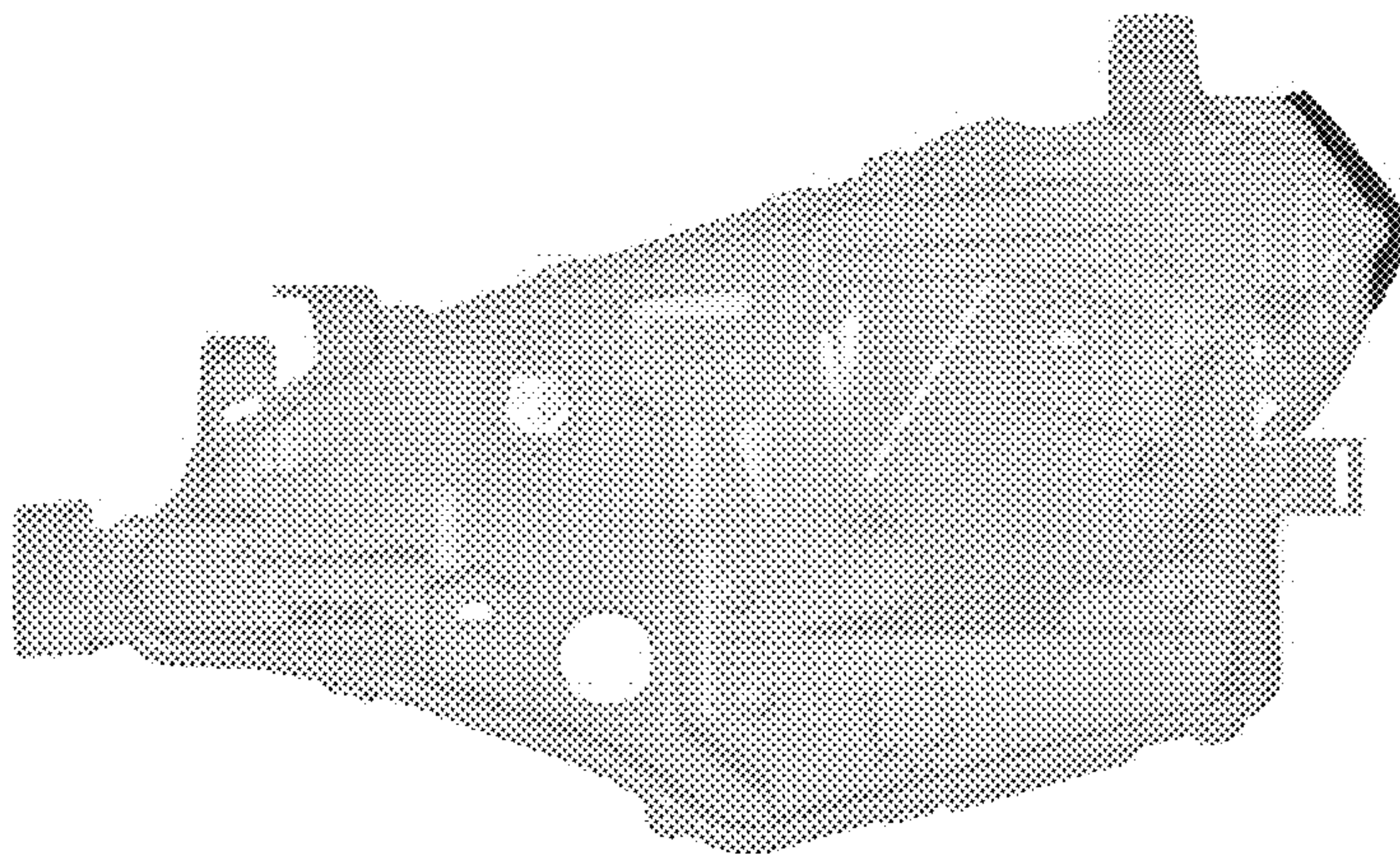

Fig. 3

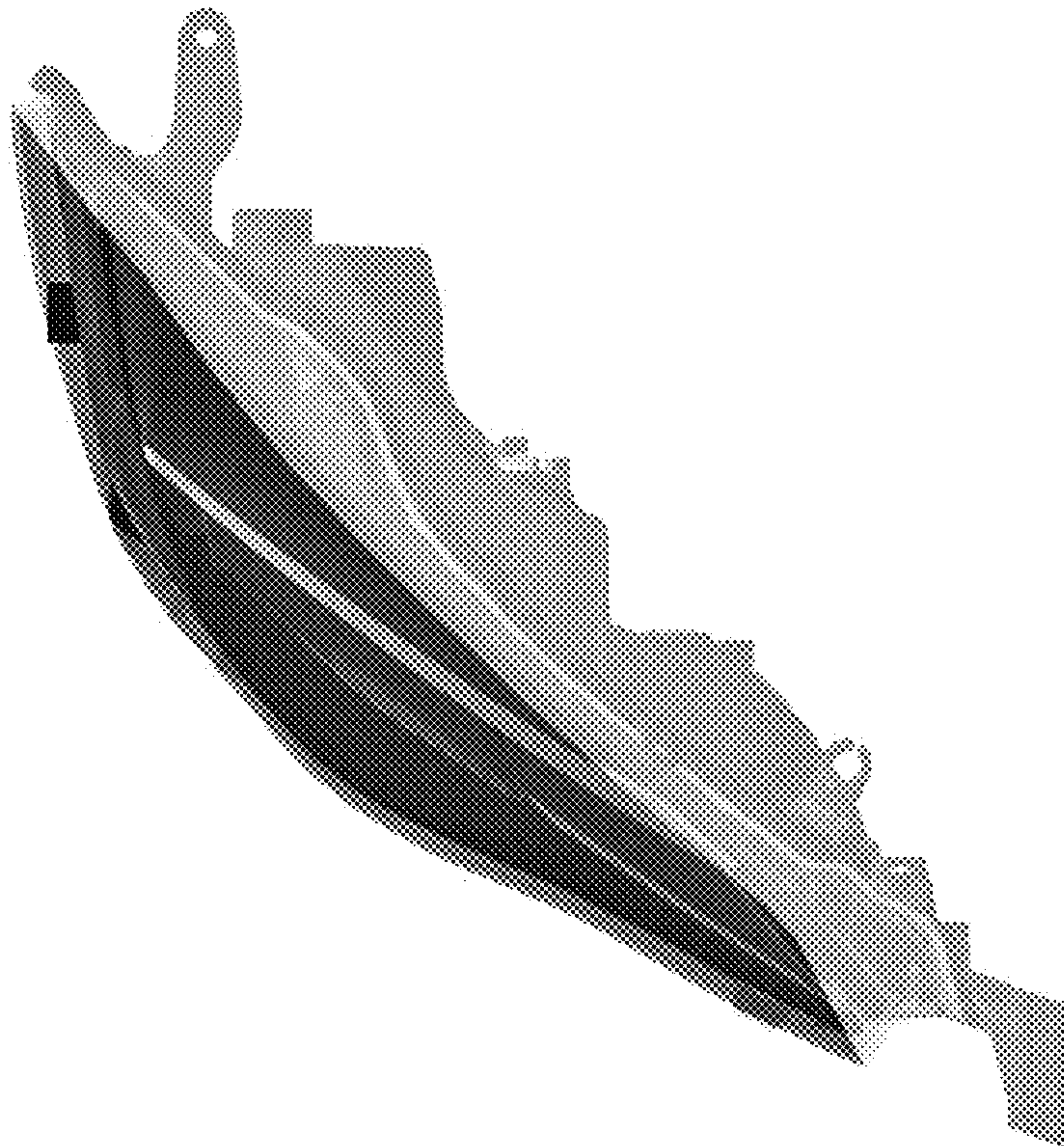

Fig. 4

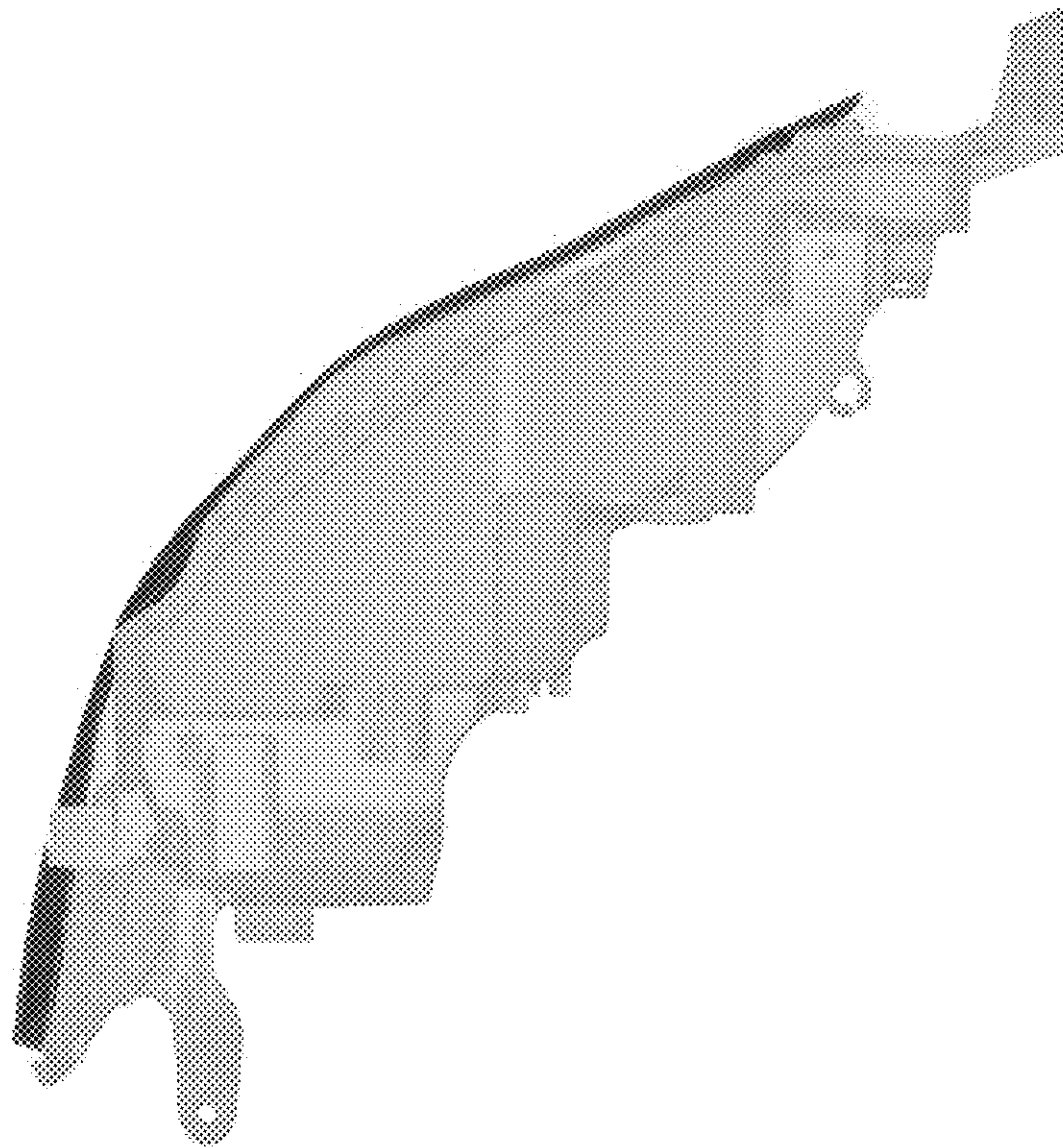

Fig. 5

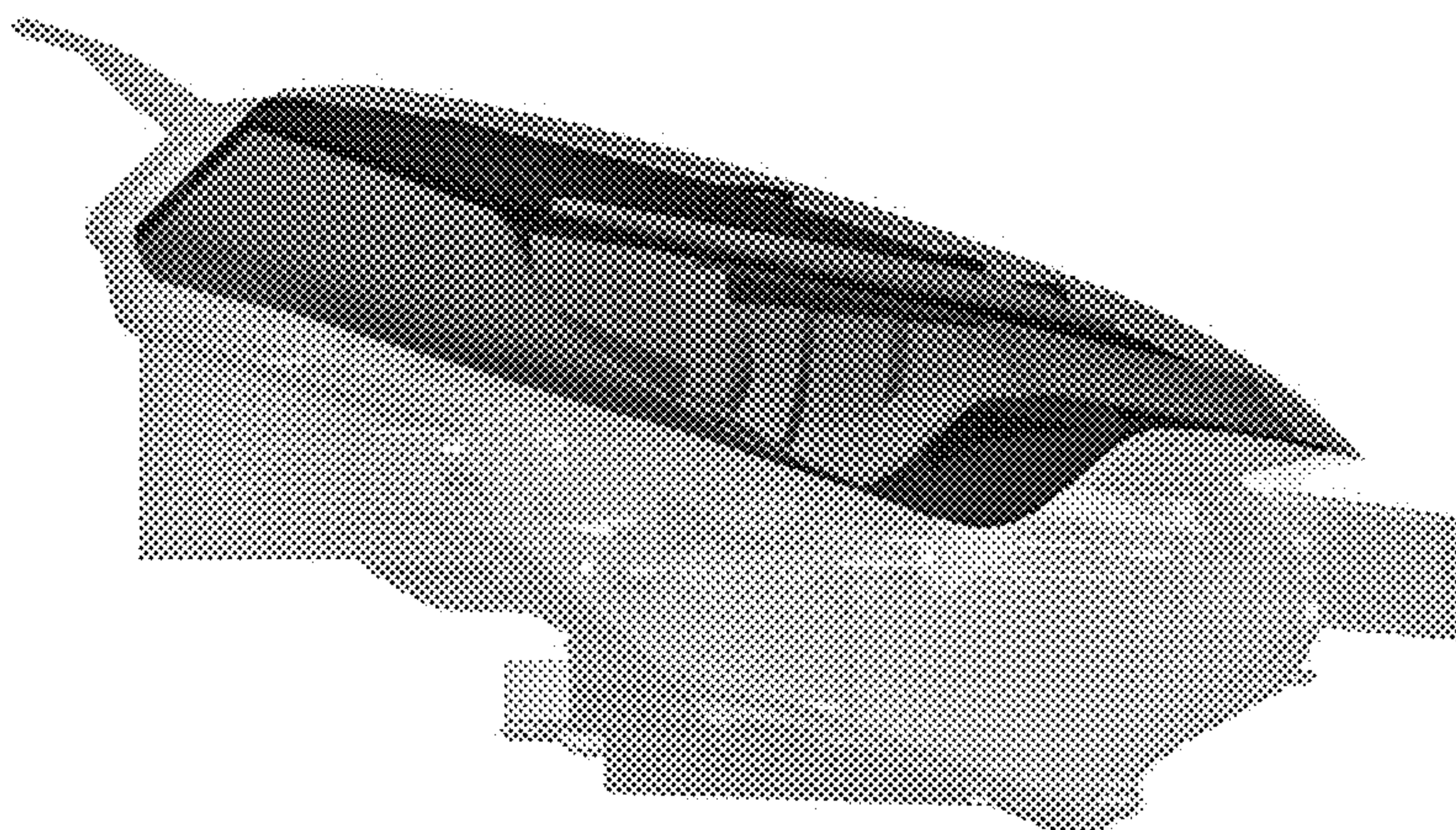

Fig. 6

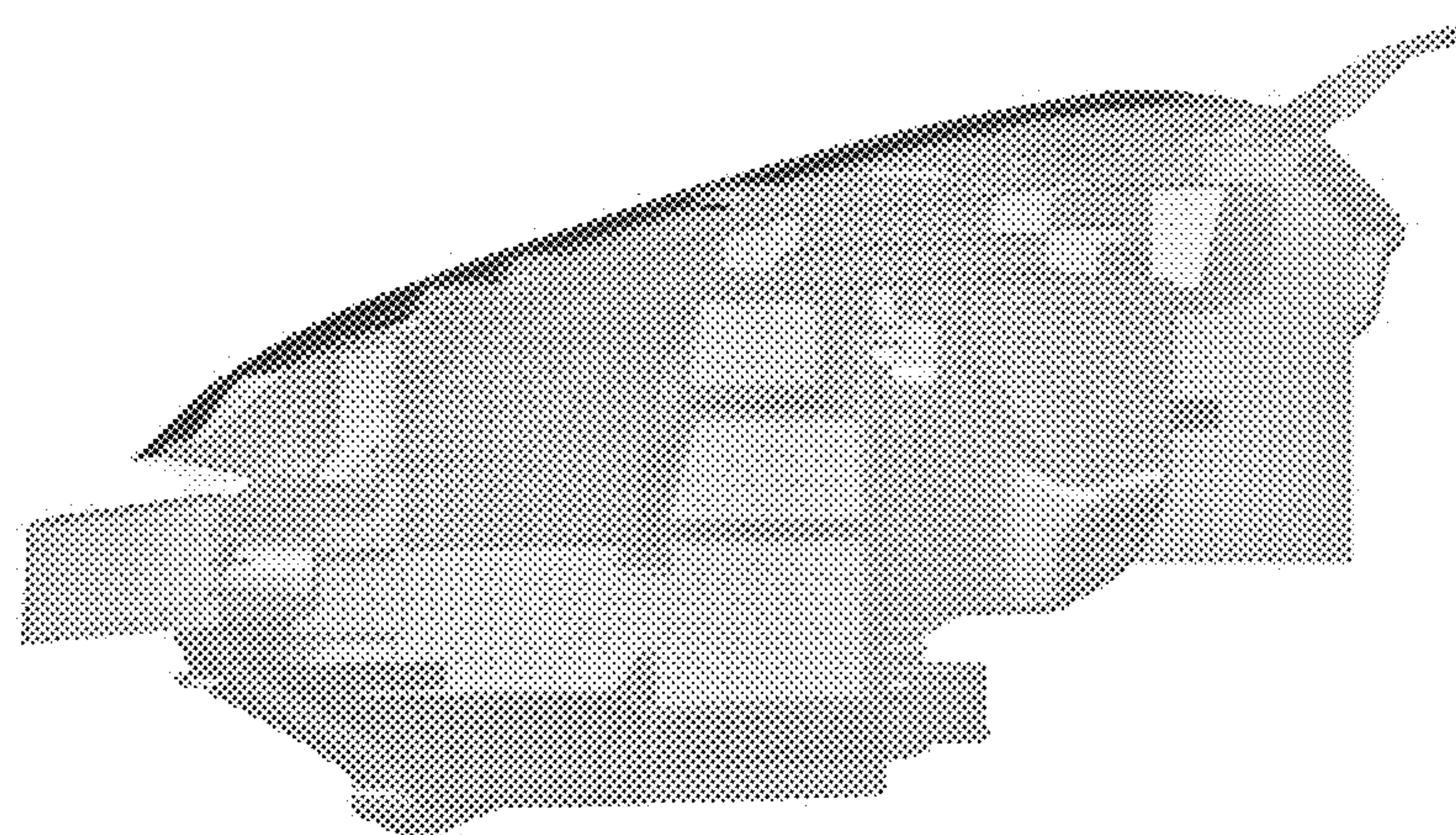

Fig. 7