



US00D782083S

(12) **United States Design Patent**  
**Huang**

(10) **Patent No.:** **US D782,083 S**  
(45) **Date of Patent:** **\*\* Mar. 21, 2017**

- (54) **LED LIGHT**
- (71) Applicant: **Nan Huang Huang**, Rancho Palos Verdes, CA (US)
- (72) Inventor: **Nan Huang Huang**, Rancho Palos Verdes, CA (US)
- (73) Assignee: **Grand General Accessories Manufacturing**, Rancho Dominguez, CA (US)
- (\*\*) Term: **14 Years**
- (21) Appl. No.: **29/500,005**
- (22) Filed: **Aug. 20, 2014**
- (51) **LOC (10) Cl.** ..... **26-06**
- (52) **U.S. Cl.**  
USPC ..... **D26/28**
- (58) **Field of Classification Search**  
USPC ..... D26/2, 28-36, 118; 362/459-468, 362/475-478, 485-487; 219/220  
CPC ... B60Q 1/0047; F21S 48/115; F21S 48/1145; F21S 48/1291; F21S 48/2275; F21S 48/1258  
See application file for complete search history.

D578,680 S *	10/2008	Huang	.....	D26/28
D586,486 S *	2/2009	DiPenti	.....	D26/28
D592,778 S *	5/2009	Chang	.....	D26/28
D614,781 S *	4/2010	Huang	.....	D26/2
D617,474 S *	6/2010	Huang	.....	D26/2
7,914,162 B1 *	3/2011	Huang	.....	B60L 1/14 219/220
D660,506 S *	5/2012	McMahan	.....	D26/118
D693,035 S *	11/2013	Datz	.....	D26/28
D711,565 S *	8/2014	Tsai	.....	D26/28
D715,976 S *	10/2014	Chou	.....	D26/28
9,052,070 B2 *	6/2015	Davis	.....	B29C 45/14467
9,057,498 B2 *	6/2015	Nall	.....	F21V 5/04

\* cited by examiner

*Primary Examiner* — Lakiya Rogers  
*Assistant Examiner* — Harold Blackwell, II  
(74) *Attorney, Agent, or Firm* — Thomas I. Rozsa

(57) **CLAIM**

The ornamental design for an LED light, as shown and described.

**DESCRIPTION**

FIG. 1 is a front perspective view of the LED light, showing my new design;  
FIG. 2 is a rear perspective view thereof;  
FIG. 3 is a front view thereof;  
FIG. 4 is a rear view thereof;  
FIG. 5 is a top view thereof;  
FIG. 6 is a bottom view thereof;  
FIG. 7 is a right side view thereof; and,  
FIG. 8 is a left side view thereof.

**1 Claim, 6 Drawing Sheets**

- (56) **References Cited**  
U.S. PATENT DOCUMENTS  
D570,012 S \* 5/2008 Huang ..... D26/28  
D578,230 S \* 10/2008 Huang ..... D26/28  
D578,677 S \* 10/2008 Huang ..... D26/28  
D578,678 S \* 10/2008 Huang ..... D26/28

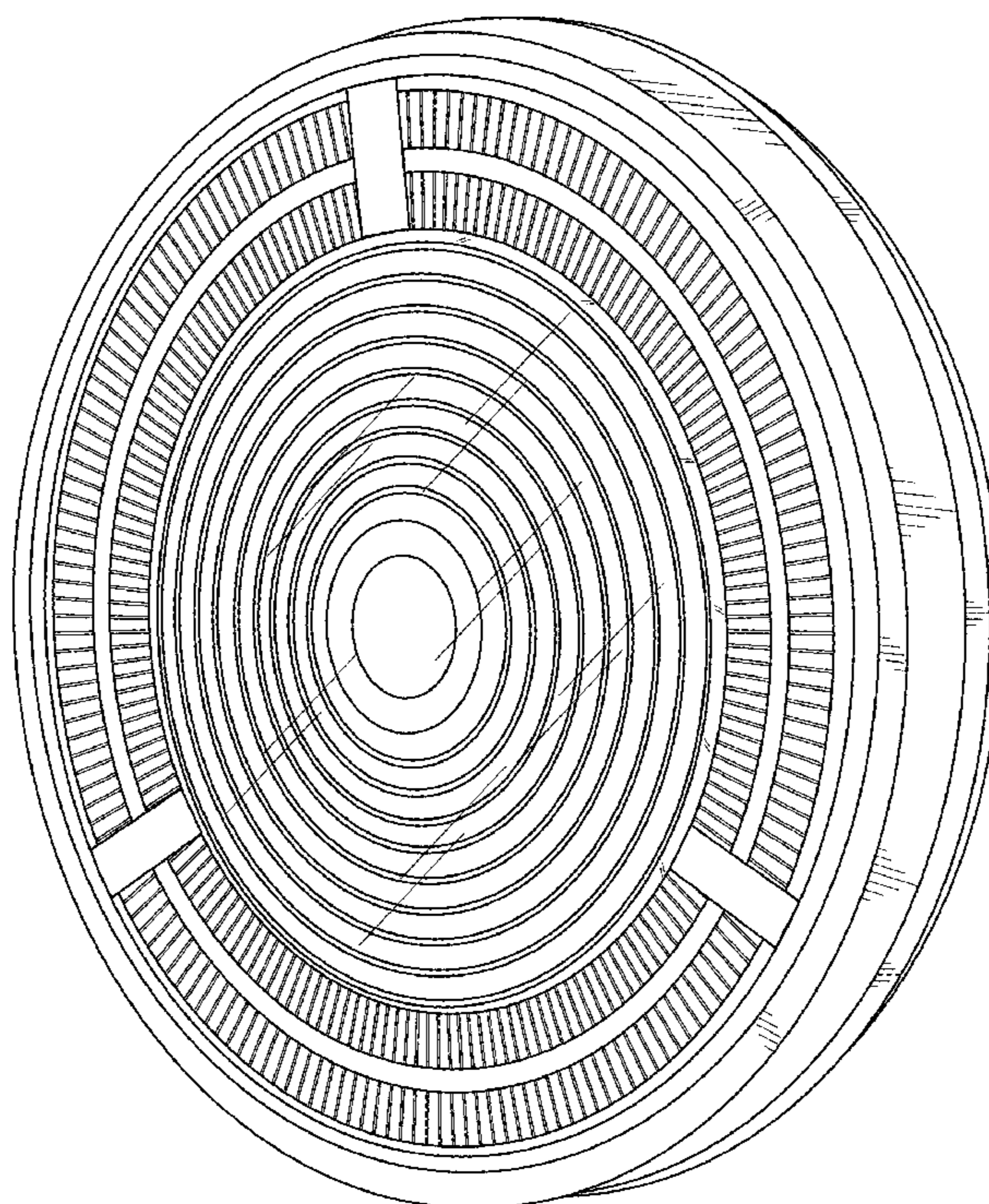

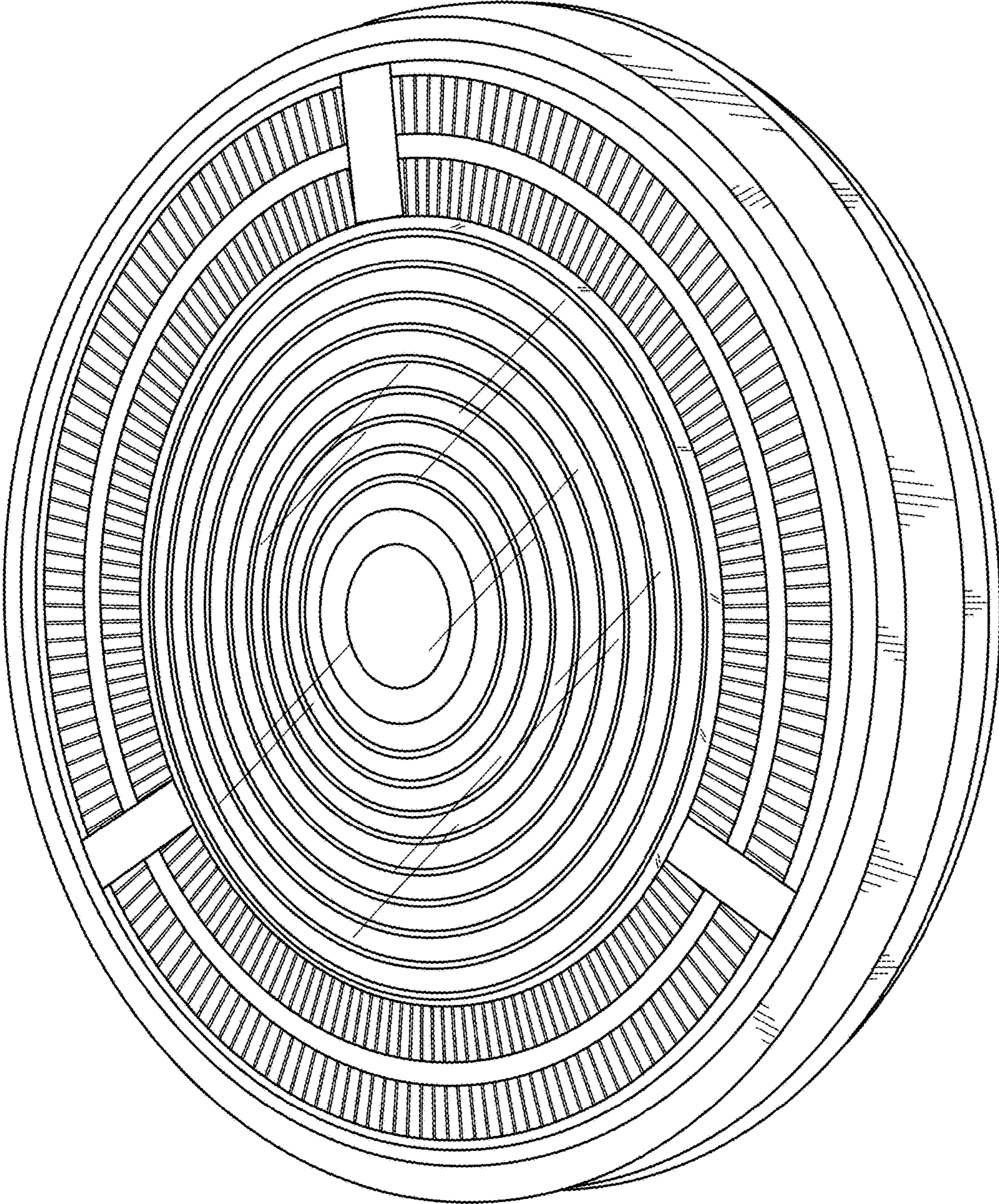

FIG. 1

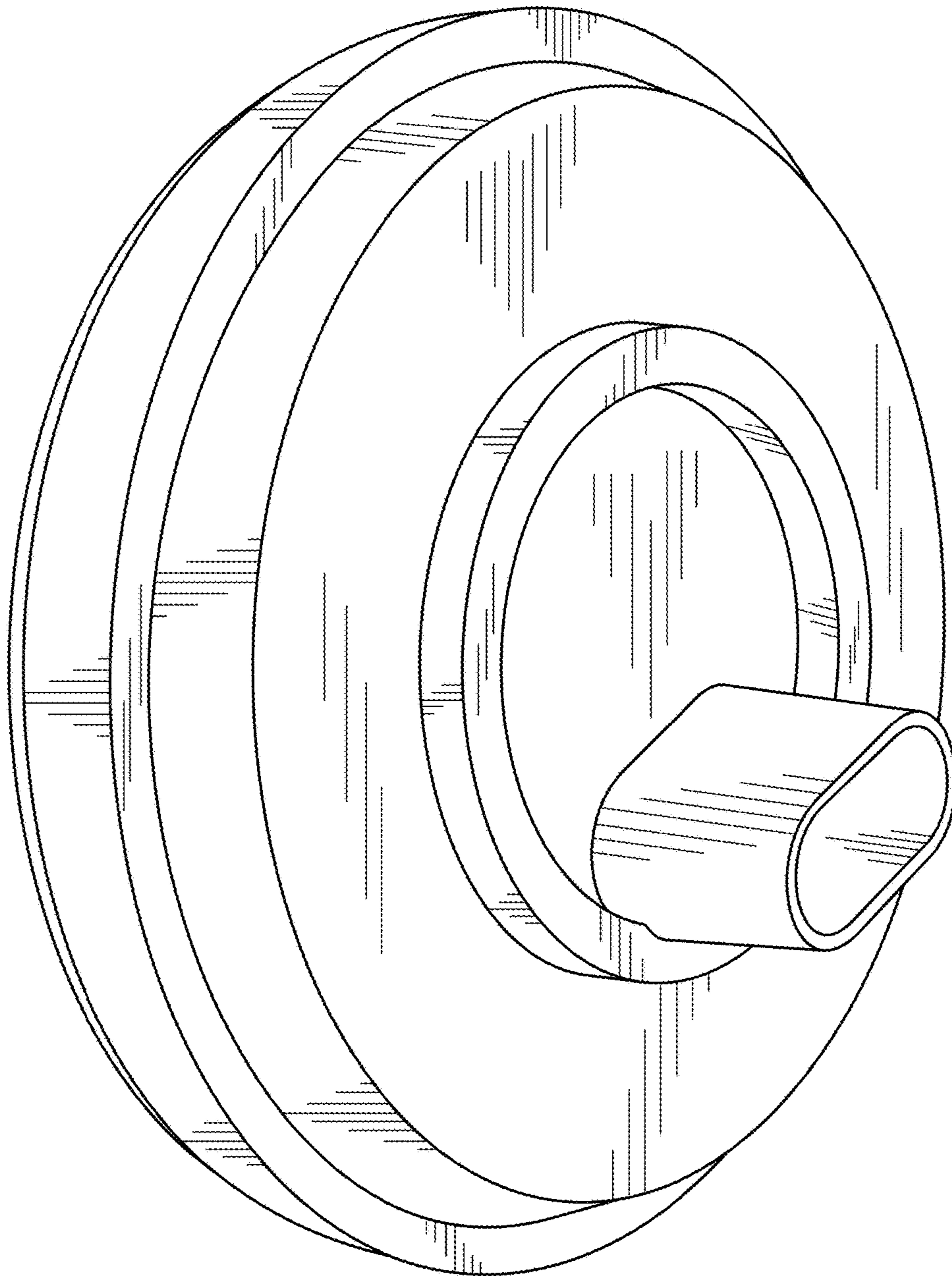

FIG. 2

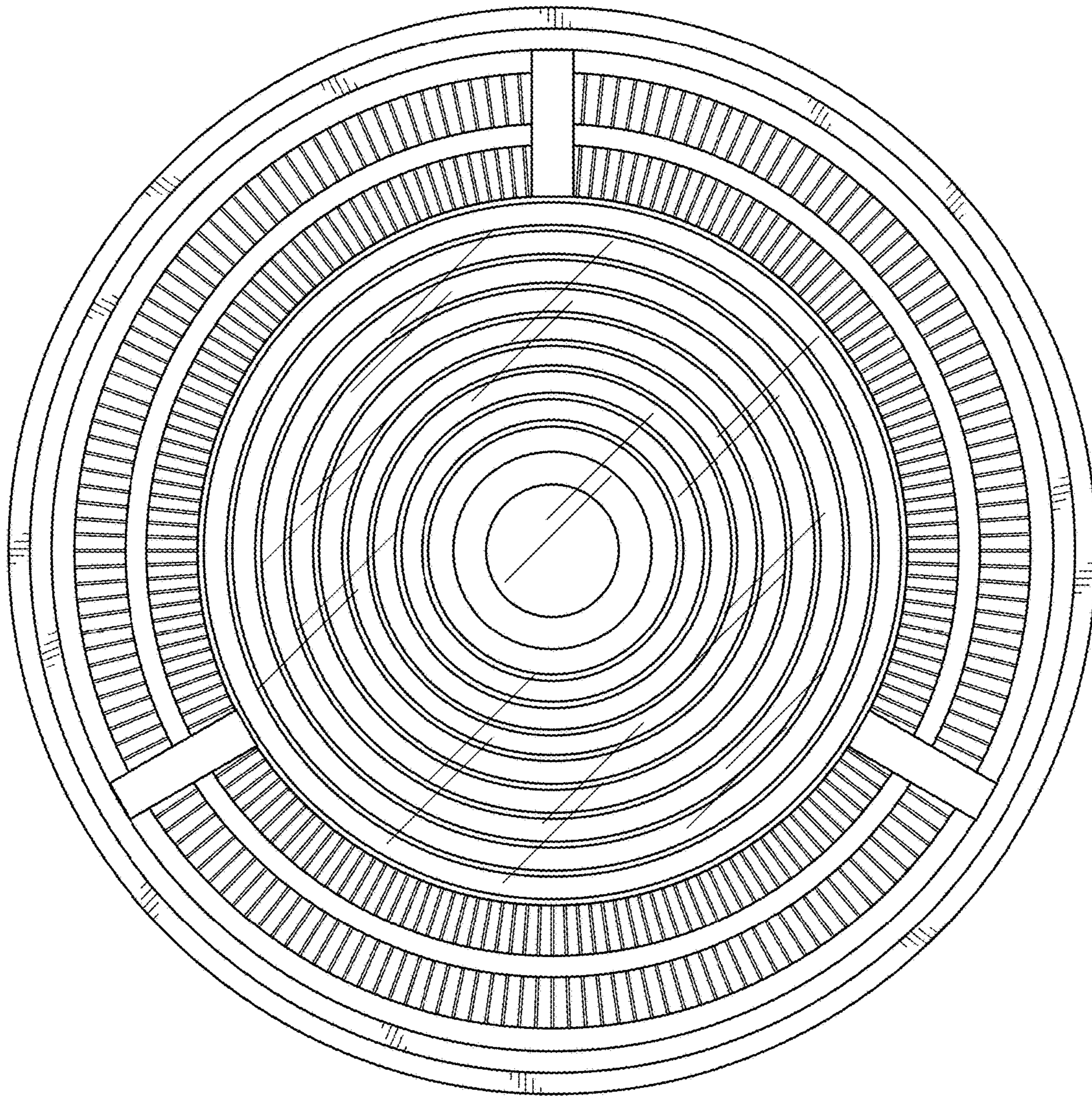

FIG. 3

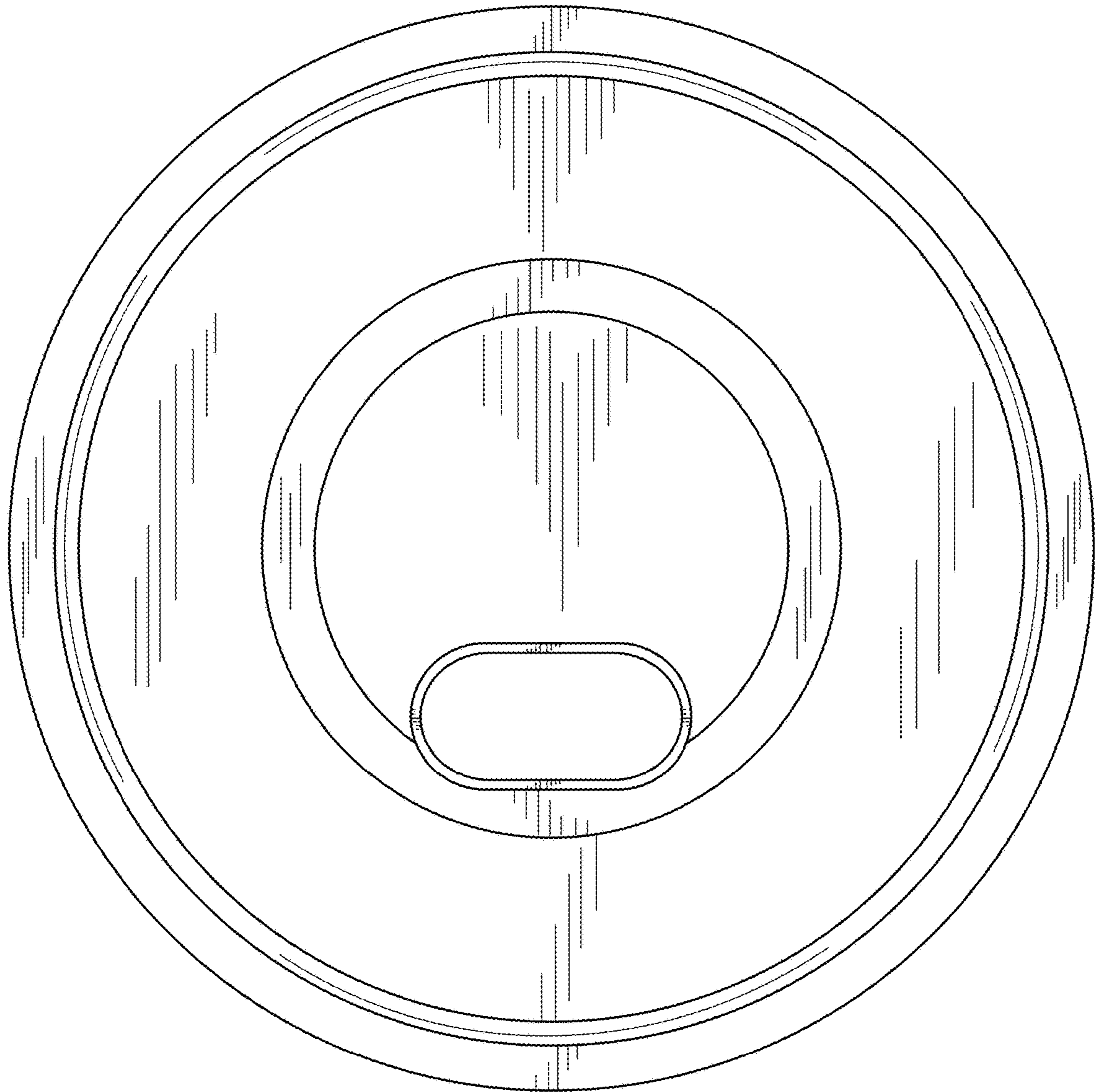

FIG. 4

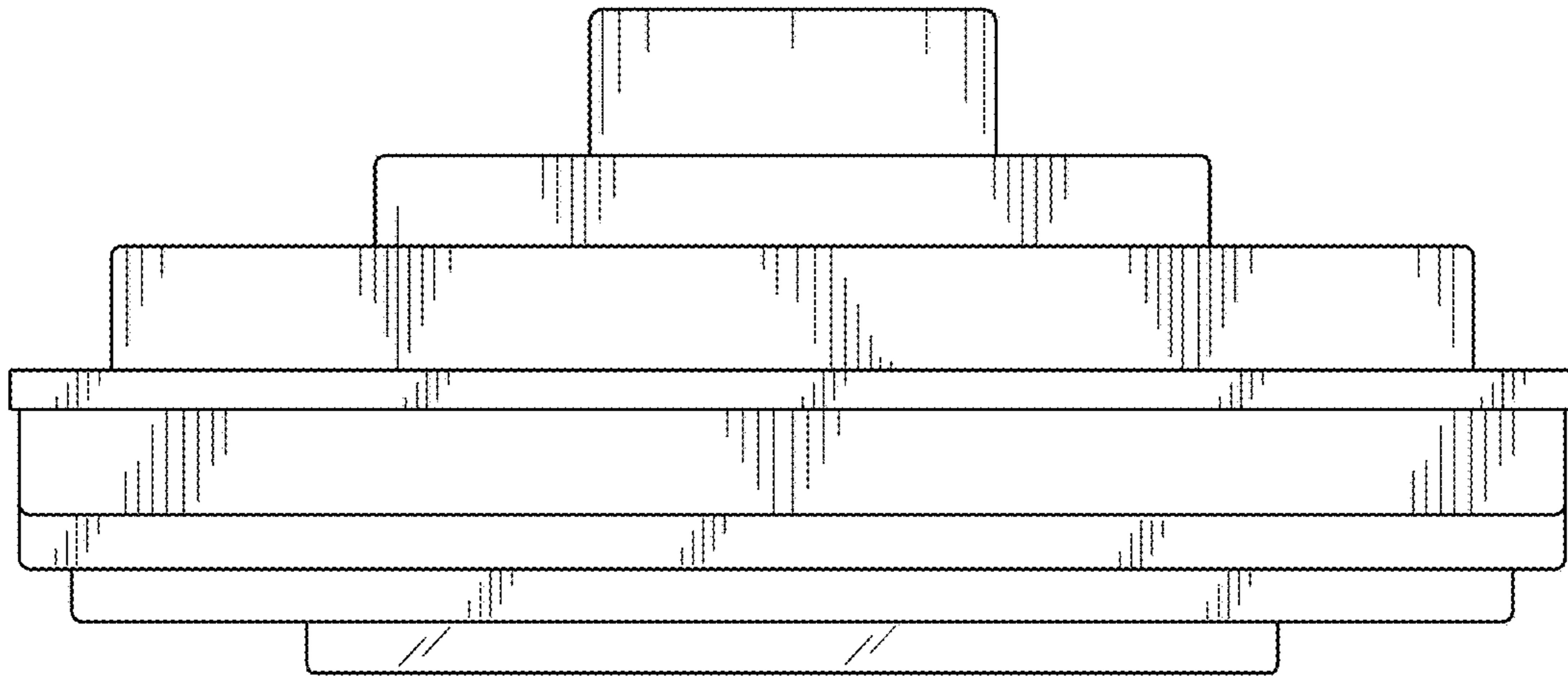

FIG. 5

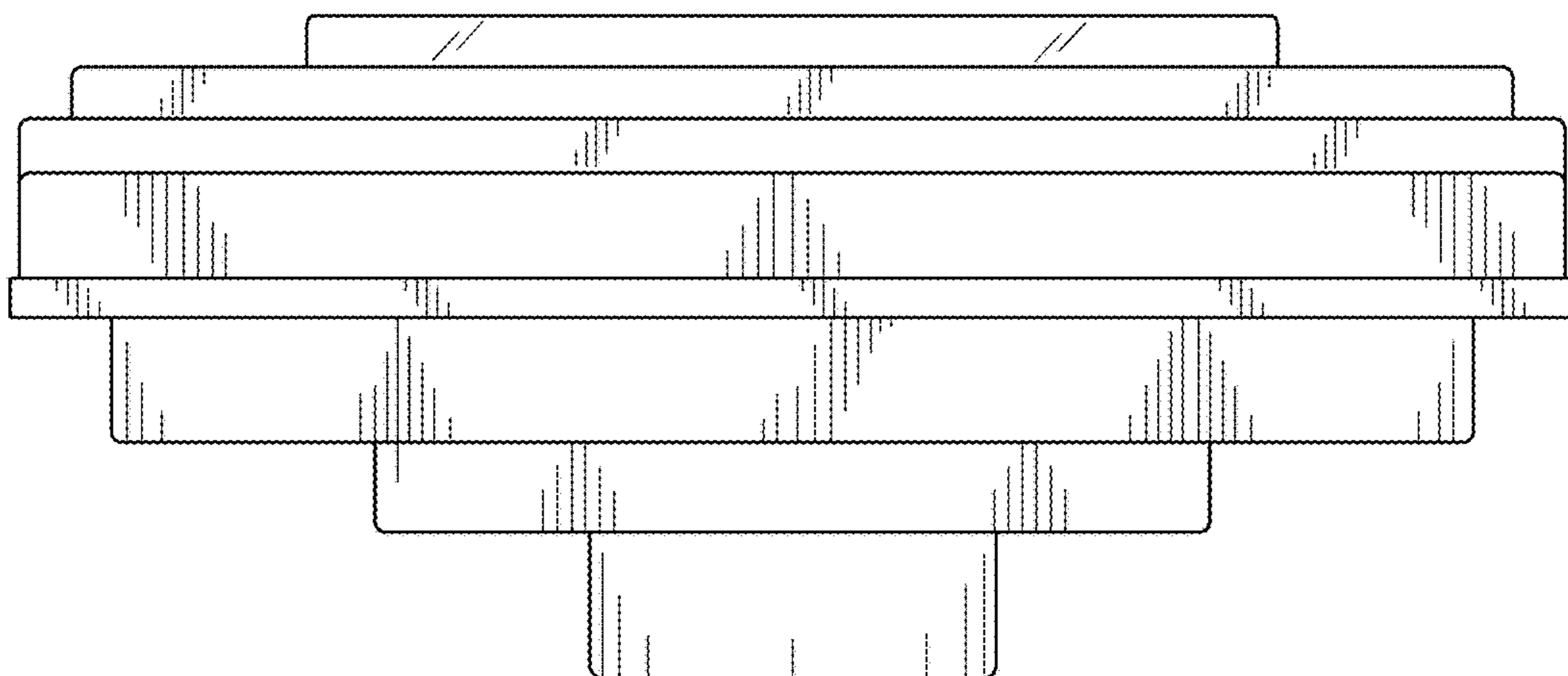

FIG. 6

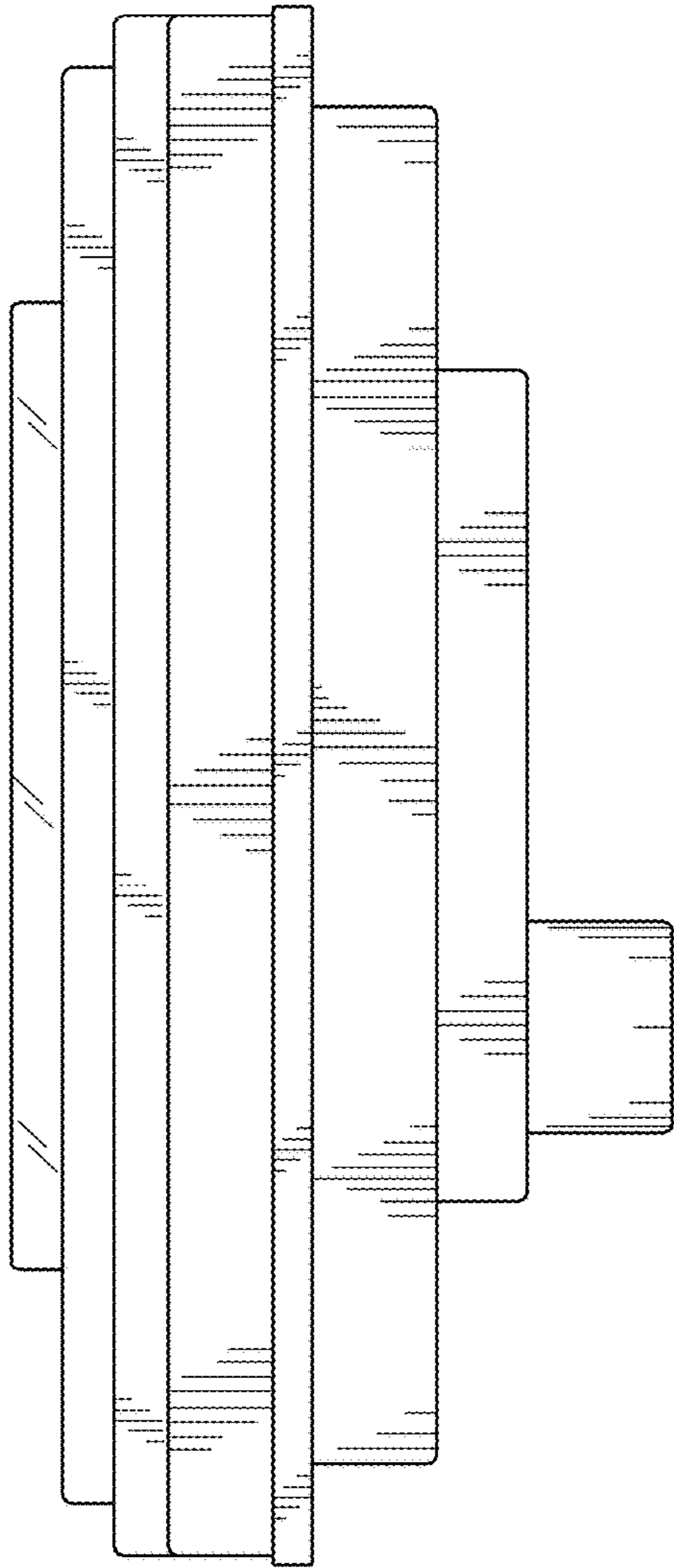

FIG. 7

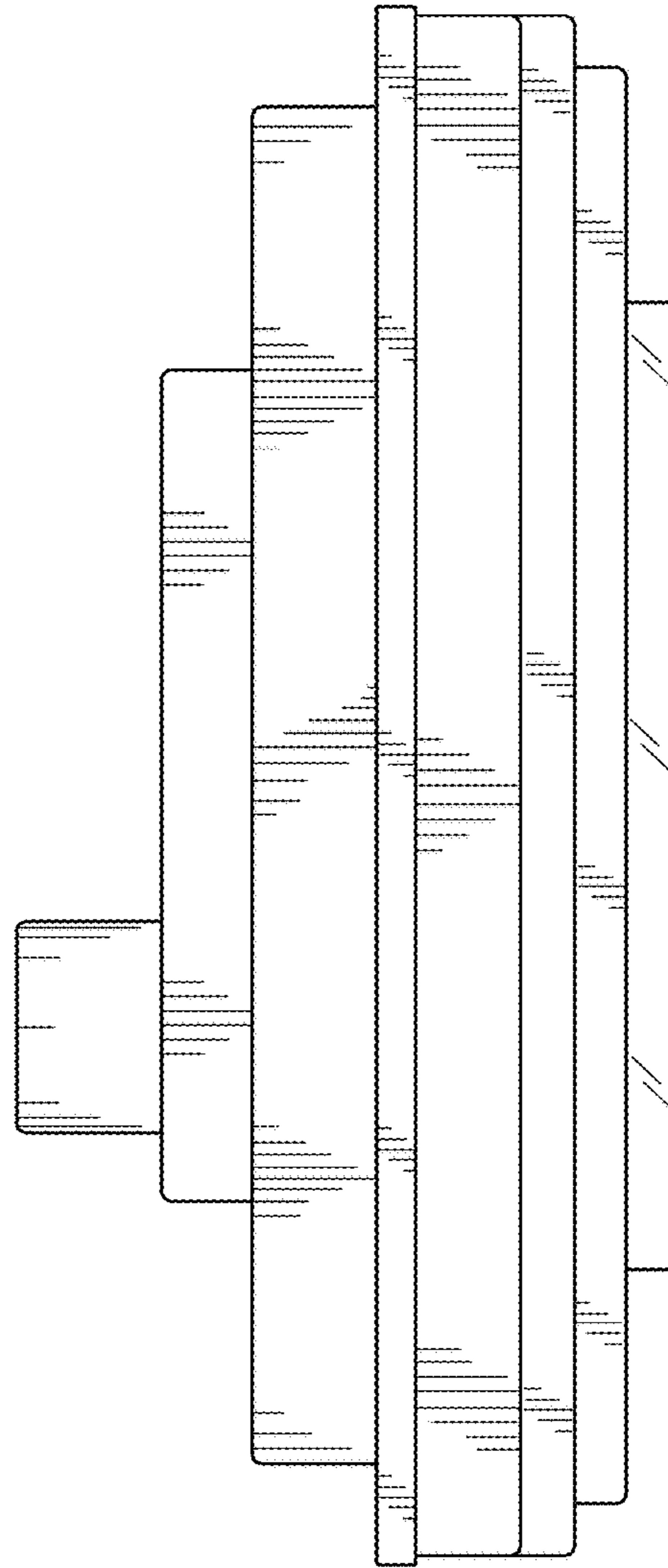

FIG. 8