



US00D782069S

(12) **United States Design Patent** (10) **Patent No.:** **US D782,069 S**  
**McGrath et al.** (45) **Date of Patent:** **\*\* Mar. 21, 2017**

(54) **WALL WITH TABLE FOR STORE WITHIN STORE**

(71) Applicant: **Google Inc.**, Mountain View, CA (US)

(72) Inventors: **Lachlan McGrath**, Cupertino, CA (US); **Joshua Hanson**, Stillwater, MN (US); **Adam Jan Tolsma**, St. Paul, MN (US)

(73) Assignee: **GOOGLE INC.**, Mountain View, CA (US)

(\*\*) Term: **14 Years**

(21) Appl. No.: **29/507,931**

(22) Filed: **Oct. 31, 2014**

(51) **LOC (10) Cl.** ..... **25-02**

(52) **U.S. Cl.**  
USPC ..... **D25/58**

(58) **Field of Classification Search**  
USPC ..... D6/329, 335, 336, 657, 662, 672, 698, D6/702, 708; D25/1, 16, 17, 18, 33, 36,  
(Continued)

(56) **References Cited**

**U.S. PATENT DOCUMENTS**

2,237,080 A \* 4/1941 Muse ..... A47F 9/04  
186/66  
4,154,027 A \* 5/1979 Searcy ..... A47F 10/02  
186/52

(Continued)

**FOREIGN PATENT DOCUMENTS**

FR 080178-001 \* 5/2008

**OTHER PUBLICATIONS**

<http://www.radiohamburg.de/Nachrichten/Deutschland-und-die-Welt/Internet-Co/2013/September/Erster-Google-Shop-in-Shop-in-Hamburg> Posted Sep. 13, 2013.\*

(Continued)

*Primary Examiner* — Susan Bennett Hattan

*Assistant Examiner* — Leanne Was

(74) *Attorney, Agent, or Firm* — Leason Ellis LLP

(57) **CLAIM**

The ornamental design for wall with table for store within store, as shown and described.

**DESCRIPTION**

FIG. 1 is a perspective view of wall with table for store within store according to a first embodiment of our new design;

FIG. 2 is a perspective view of the design of FIG. 1 shown rotated 180 degrees;

FIG. 3 is a top view of the design of FIG. 1;

FIG. 4 is a front side view of the design of FIG. 1;

FIG. 5 is a rear side view of the design of FIG. 1;

FIG. 6 is a left side view of the design of FIG. 1;

FIG. 7 is a right side view of the design of FIG. 1; and,

FIG. 8 is a perspective view of a second embodiment of our new design which differs from the first embodiment in having contrasting material on a top surface of the facing walls.

The dash-dash broken lines illustrate environmental structure and form no part of the claimed design.

The curved dash-dot-dash broken-away lines indicate break lines and the appearance of any portion of the article on or between the break lines forms no part of the claimed design.

**1 Claim, 6 Drawing Sheets**

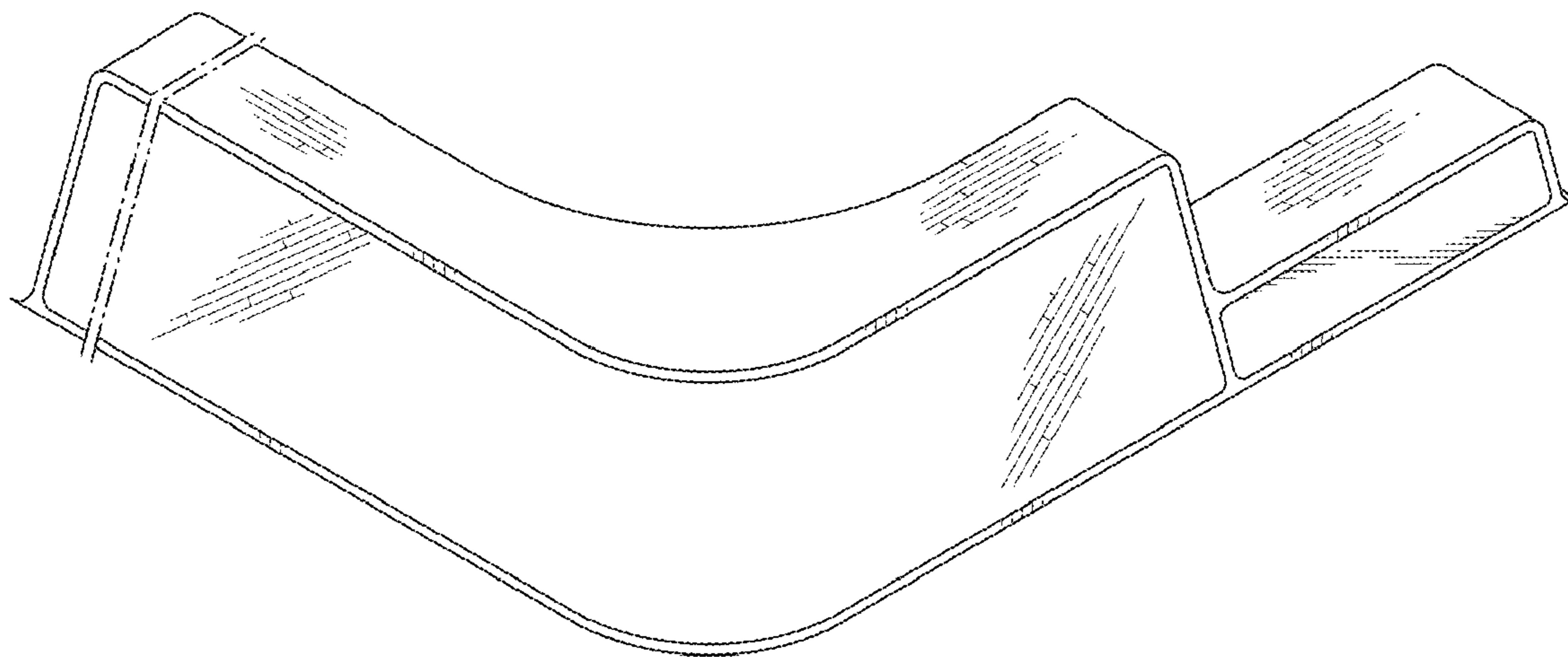

(58) **Field of Classification Search**

USPC ..... D25/55, 56, 58, 59; 52/33, 36.1, 36.2,  
52/79.1, 79.4, 79.5, 234; 312/140.1  
CPC . E04H 3/04; E04H 1/1272; A47F 9/00; A47F  
9/04; A47F 10/02

See application file for complete search history.

D694,428 S \* 11/2013 Eckert ..... D25/35  
D694,912 S \* 12/2013 Eckert ..... D25/35  
D733,440 S \* 7/2015 McGrath ..... D6/335  
D733,441 S \* 7/2015 McGrath ..... D6/335  
D742,537 S \* 11/2015 Graham ..... D25/1  
2013/0192153 A1\* 8/2013 Kobe ..... E04H 3/02  
52/234

(56) **References Cited**

U.S. PATENT DOCUMENTS

4,274,233 A 6/1981 Currier  
4,288,948 A \* 9/1981 Harris ..... E04H 3/04  
52/28  
D395,521 S \* 6/1998 De Leu ..... D25/58  
D488,332 S \* 4/2004 Muenzberg ..... D6/702  
D488,649 S \* 4/2004 Muenzberg ..... D6/699.2  
D488,650 S \* 4/2004 Muenzberg ..... D6/702  
D638,551 S \* 5/2011 Gann ..... D25/16  
D670,929 S \* 11/2012 Pinette ..... D6/673  
D674,114 S \* 1/2013 Van De Ven ..... D25/58  
D694,426 S \* 11/2013 Eckert ..... D25/35  
D694,427 S \* 11/2013 Eckert ..... D25/35

OTHER PUBLICATIONS

<http://www.popai.com/industry-news-blog/google-unveils-first-physical-storefront> Posted Mar. 12, 2015.\*  
<http://phandroid.com/2015/03/11/google-shop-london-retail-store-vr-tour-app/> Posted Mar. 11, 2015.\*  
Intechnic: Kogan, Danielle, "Chrome Zone—Google's first retail shop opens in London," Business, On the Radar, printed prior to Oct. 31, 2014, 2 pages, [intechnic.com/blog](http://intechnic.com/blog), USA.  
Patentably Apple: Purcher, Jack, "The Apple Store's Distinctive Design & Layout is now a Registered Trademark," Jan. 24, 2013, 5 pages, [patentlyapple.com](http://patentlyapple.com), USA.

\* cited by examiner

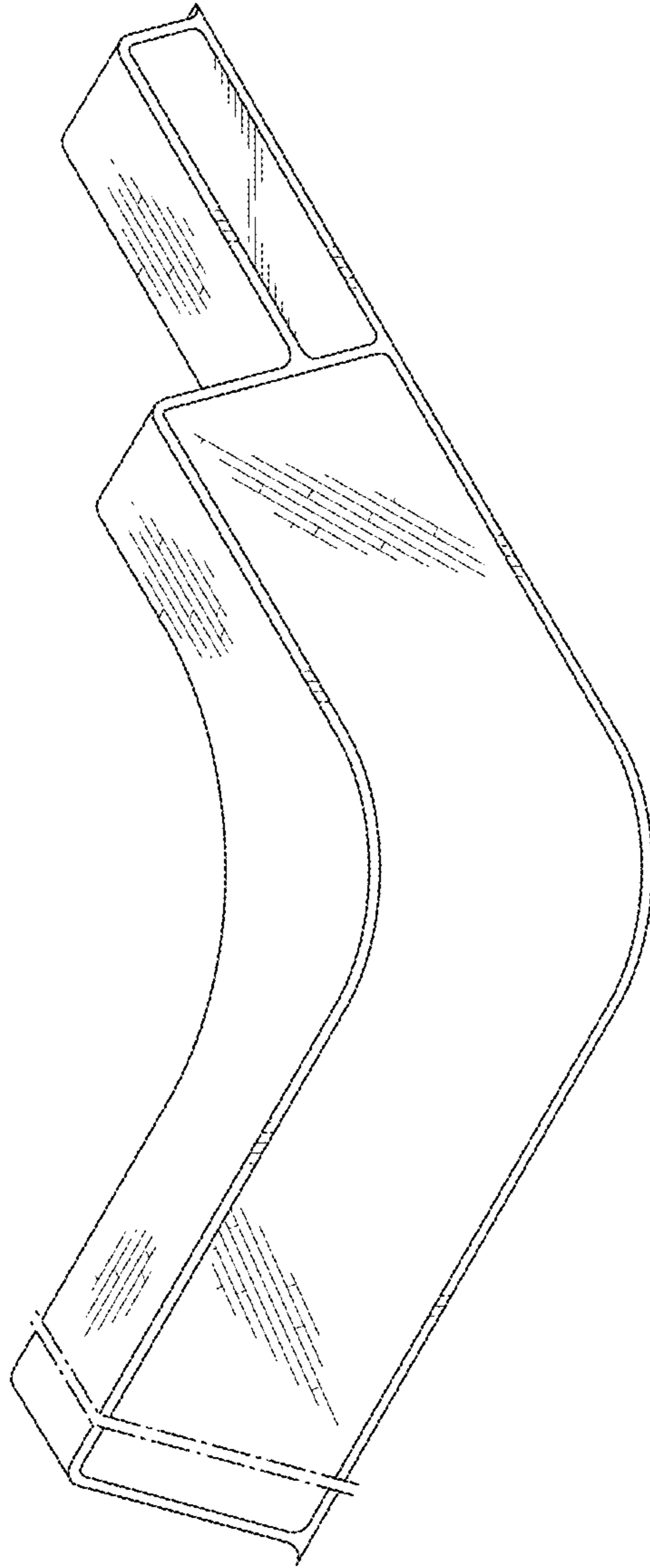

Fig. 1

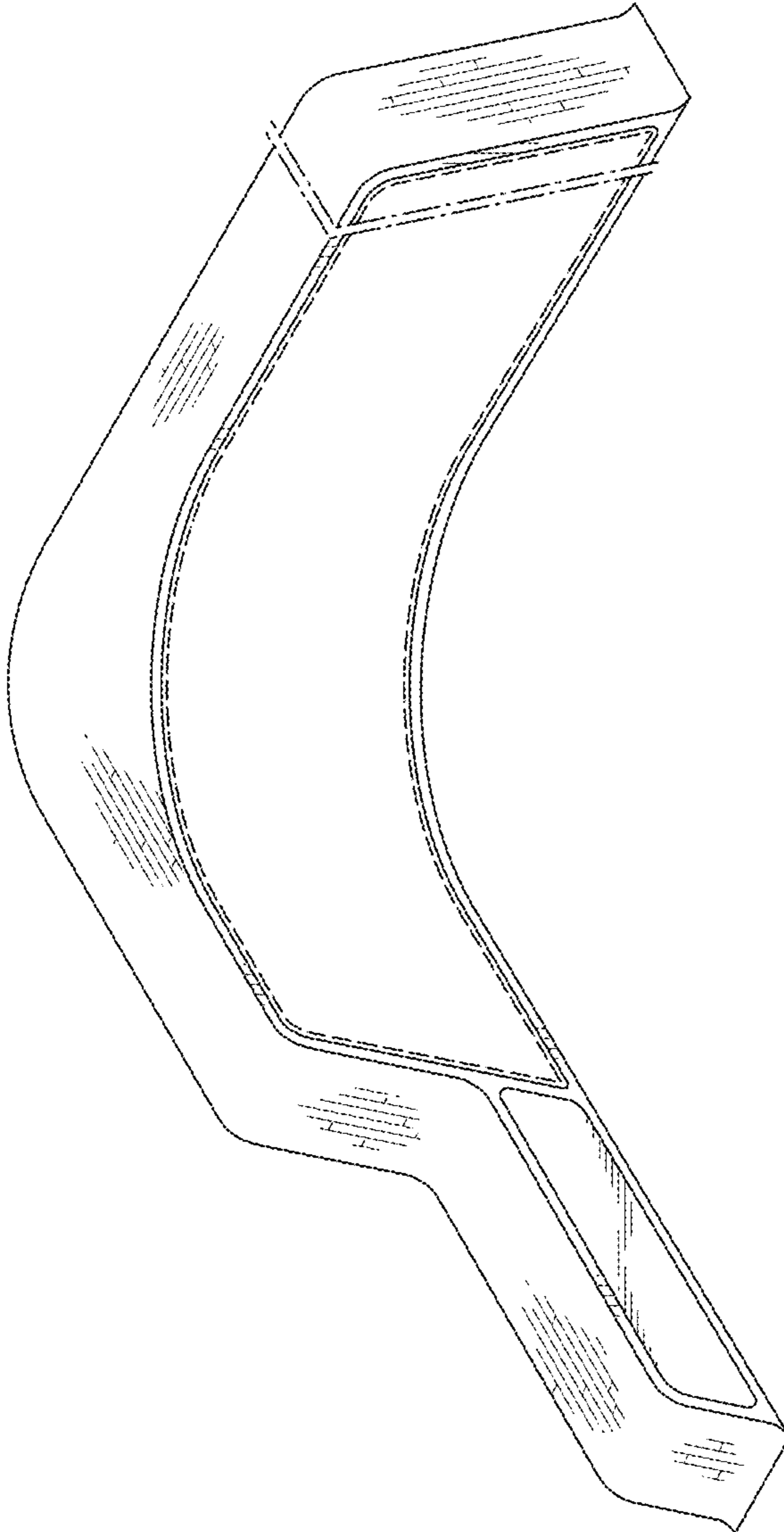

Fig. 2

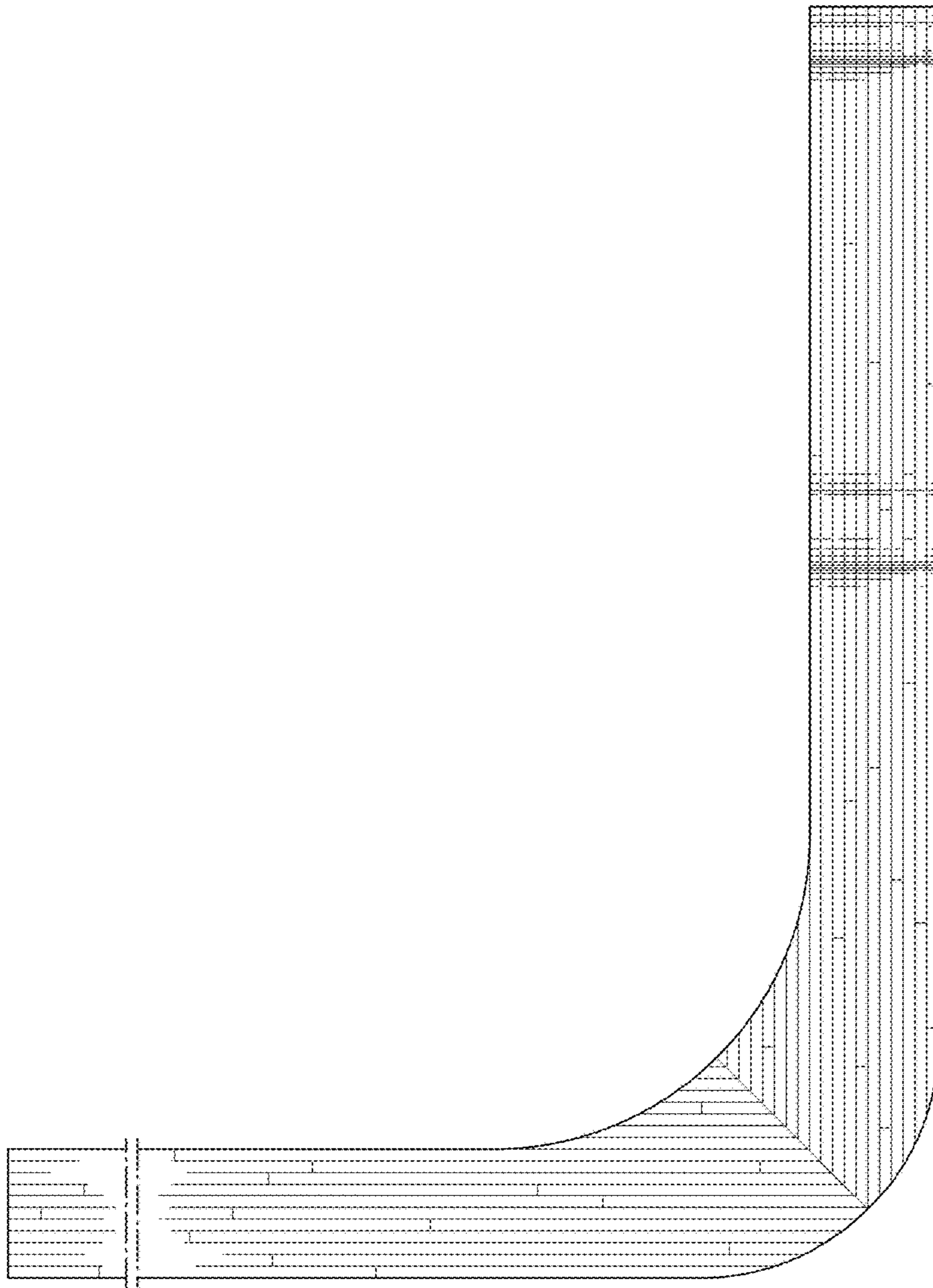

Fig. 3



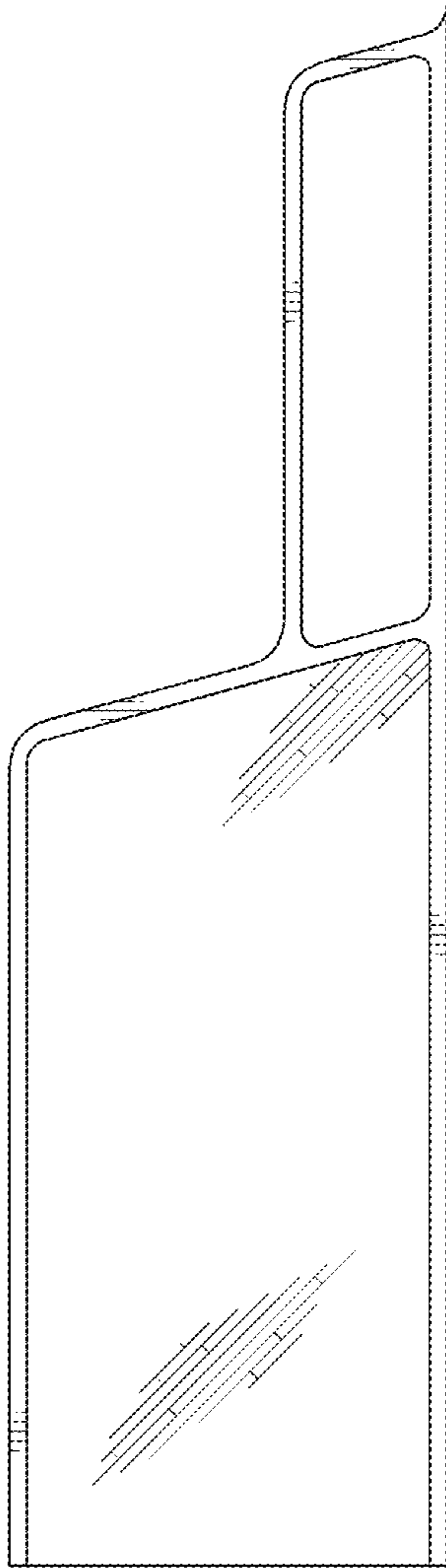

Fig. 4

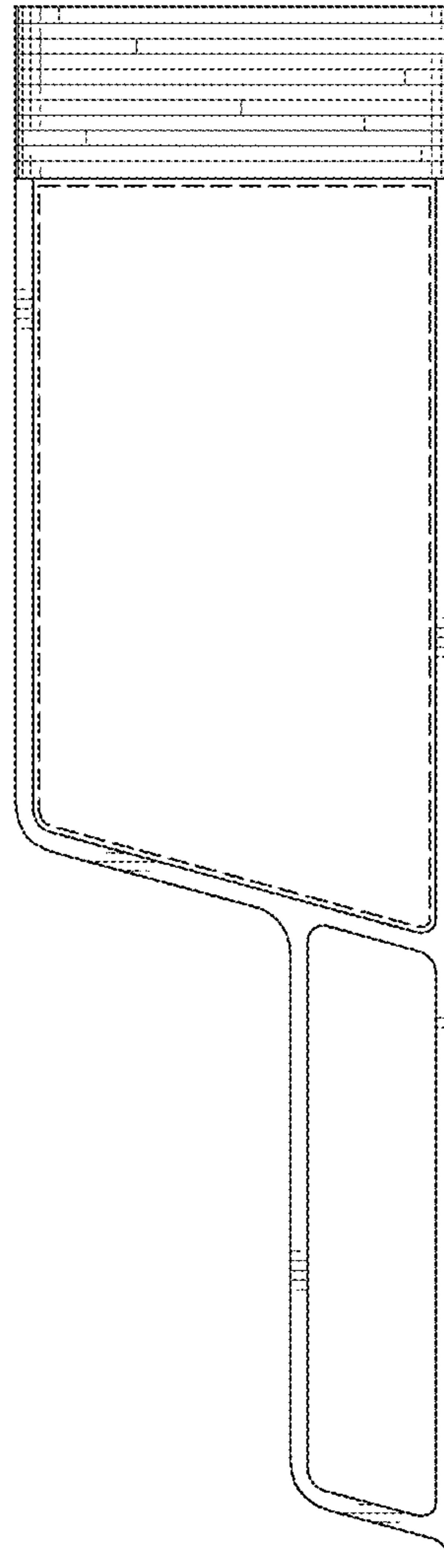

Fig. 5

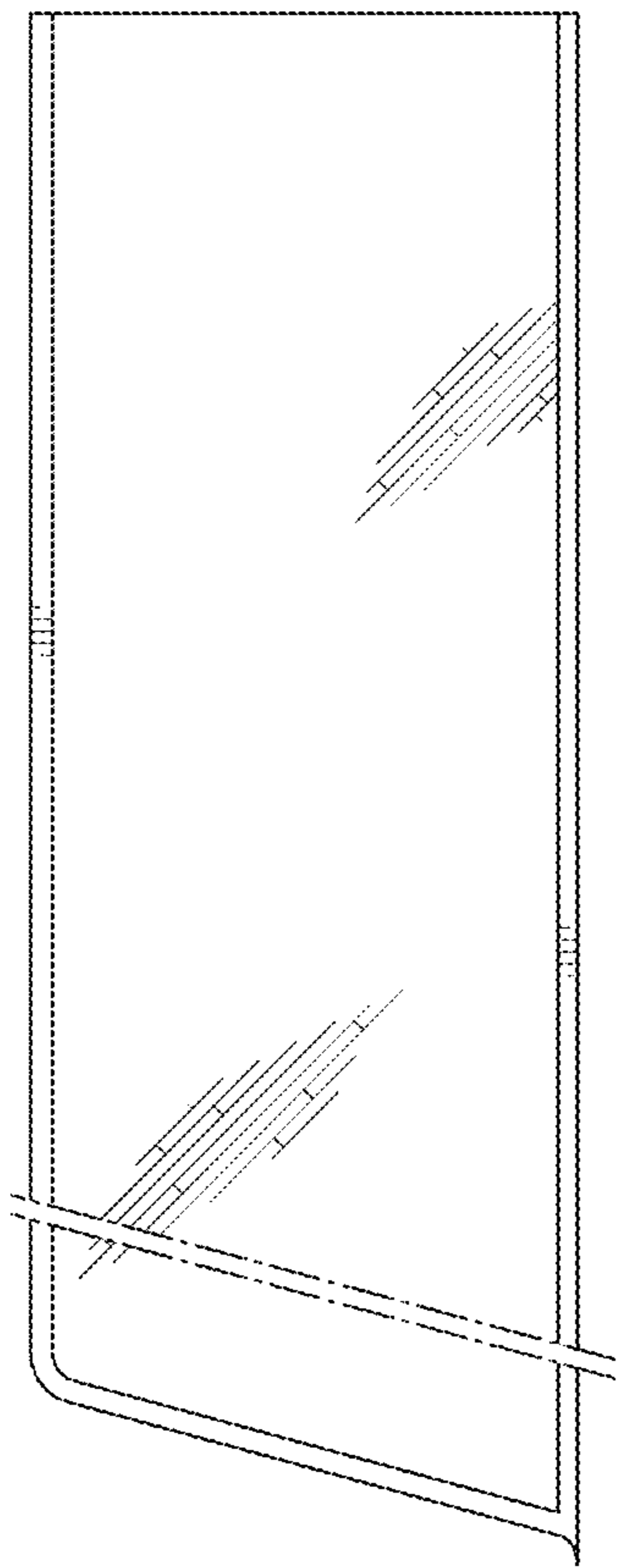

Fig. 6

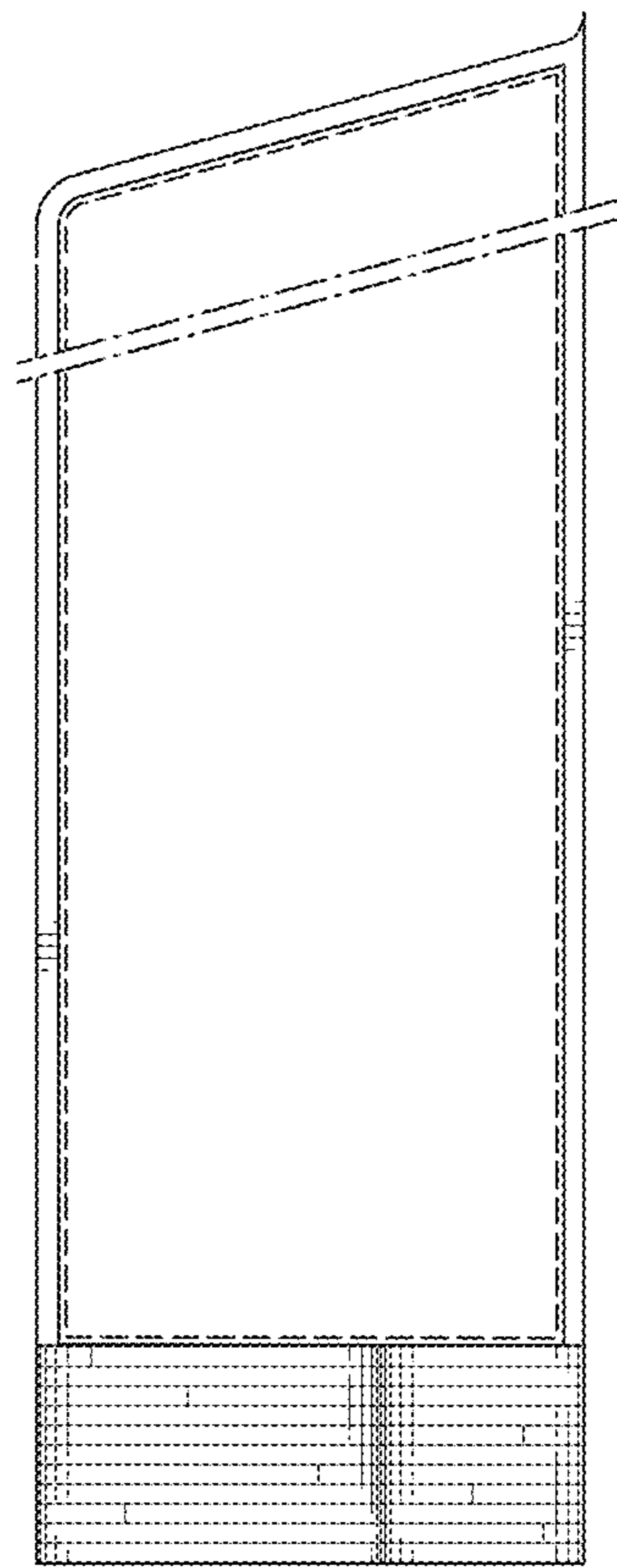

Fig. 7

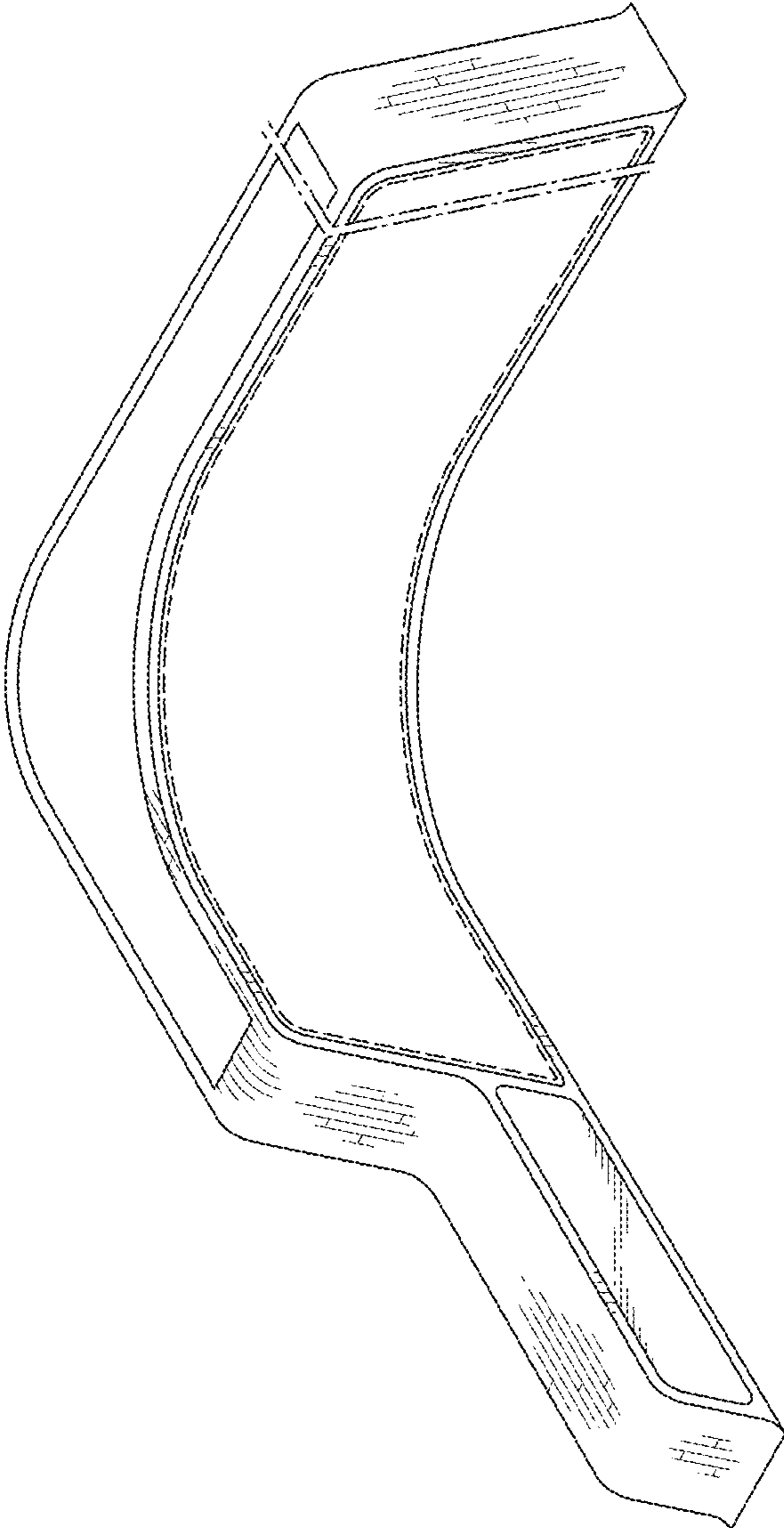

Fig. 8