



US00D781698S

(12) **United States Design Patent**
Koroukian

(10) **Patent No.:** **US D781,698 S**
(45) **Date of Patent:** **** Mar. 21, 2017**

(54) **CONTAINER**

(71) Applicant: **Interplast Co. Ltd**, Sharjah (AE)

(72) Inventor: **Melik Koroukian**, Sharjah (AE)

(73) Assignee: **Interplast Co. Ltd.**, Sharjah (AE)

(**) Term: **14 Years**

(21) Appl. No.: **29/503,825**

(22) Filed: **Sep. 30, 2014**

(30) **Foreign Application Priority Data**

Apr. 1, 2014 (EM) 002437871-0001

(51) **LOC (10) Cl.** **09-03**

(52) **U.S. Cl.**
USPC **D9/420**

(58) **Field of Classification Search**
USPC D9/423, 425, 426, 420, 415, 424;
D23/359; 206/469, 461, 365, 459.5,
206/521.1; 220/324

(Continued)

(56) **References Cited**

U.S. PATENT DOCUMENTS

D361,036 S * 8/1995 Krupa D9/423
D377,450 S * 1/1997 Krupa D9/425

(Continued)

FOREIGN PATENT DOCUMENTS

AE D21/2013 1/2013
EM 002276899-0001 7/2013
EM 002437871-0001 4/2014

OTHER PUBLICATIONS

KSA Application No. 414350639 [SA] Applicant: Interplast Co.
Ltd. Filing Date: Oct. 1, 2014.

Primary Examiner — Rhea Shields

(74) *Attorney, Agent, or Firm* — King & Schickli, PLLC

(57) **CLAIM**

The ornamental design for a container, as shown.

DESCRIPTION

FIG. 1 is a top perspective view of the container, including a lid portion in an open condition;

FIG. 2 is a bottom perspective view of the invention of FIG. 1;

FIG. 3 is a top plan view of the invention of FIG. 1;

FIG. 4 is a left side view of the invention of FIG. 1;

FIG. 5 is a right side view of the invention of FIG. 1;

FIG. 6 is bottom plan view of the invention of FIG. 1;

FIG. 7 is a front view of the invention of FIG. 1;

FIG. 8 is a rear view of the invention of FIG. 1;

FIG. 9 is a top perspective view of a base portion of the invention of FIG. 1;

FIG. 10 is a bottom perspective view of the base portion of FIG. 9;

FIG. 11 is a top plan view of the base portion of FIG. 9;

FIG. 12 is a bottom plan view of the base portion of FIG. 9;

FIG. 13 is a front view of the base portion of FIG. 9;

FIG. 14 is a rear view of the base portion of FIG. 9;

FIG. 15 is a left side view of the base portion of FIG. 9;

FIG. 16 is a right side view of the base portion of FIG. 9;

FIG. 17 is a top perspective view of a lid portion of the invention of FIG. 1;

FIG. 18 is a bottom perspective view of the lid portion of FIG. 17;

FIG. 19 is a top view of the lid portion of FIG. 17;

FIG. 20 is a left side view of the lid portion of FIG. 17;

FIG. 21 is a right side view of the lid portion of FIG. 17;

FIG. 22 is a bottom view of the lid portion of FIG. 17;

FIG. 23 is a front view of the lid portion of FIG. 17; and,

FIG. 24 is a back view of the lid portion of FIG. 17.

1 Claim, 18 Drawing Sheets

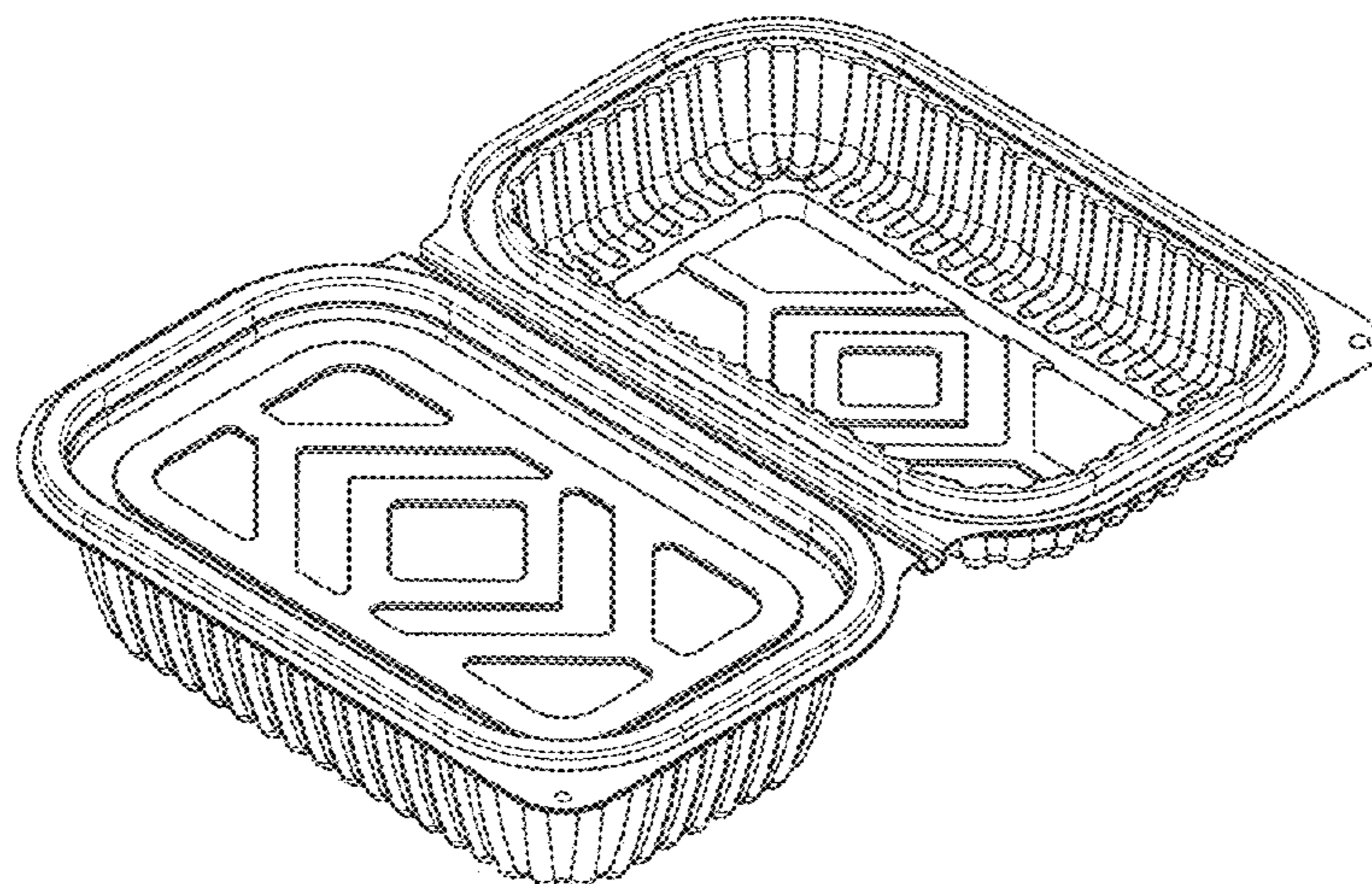

(58) **Field of Classification Search**

CPC B65D 75/366; B65D 85/32
See application file for complete search history.

(56) **References Cited**

U.S. PATENT DOCUMENTS

D378,192 S * 2/1997 Krupa D9/425
D380,381 S * 7/1997 Krupa D9/425
D397,610 S * 9/1998 Cooper D9/425
D536,992 S * 2/2007 Garg D9/425
D601,014 S * 9/2009 Petitjean D9/426
7,686,181 B2 * 3/2010 St-Onge B65D 85/32
220/324
7,775,364 B1 * 8/2010 Archambault B65D 85/32
206/521.1
D627,221 S * 11/2010 Kovatch D9/426
D668,536 S * 10/2012 Sanfilippo D9/423
D680,860 S * 4/2013 Schulter D9/420
D681,446 S * 5/2013 Schulter D9/420
D682,674 S * 5/2013 Krueger D9/426
D683,623 S * 6/2013 Chen D9/423
D693,671 S * 11/2013 Bontrager D9/425
D741,705 S * 10/2015 Astorga D9/425
D746,131 S * 12/2015 Astorga D9/425
D746,675 S * 1/2016 Astorga D9/425
D747,962 S * 1/2016 Astorga D9/425
D749,412 S * 2/2016 Hu D9/426
D752,430 S * 3/2016 Stevenson D9/425
D753,808 S * 4/2016 Schmidt Dios D23/359

* cited by examiner

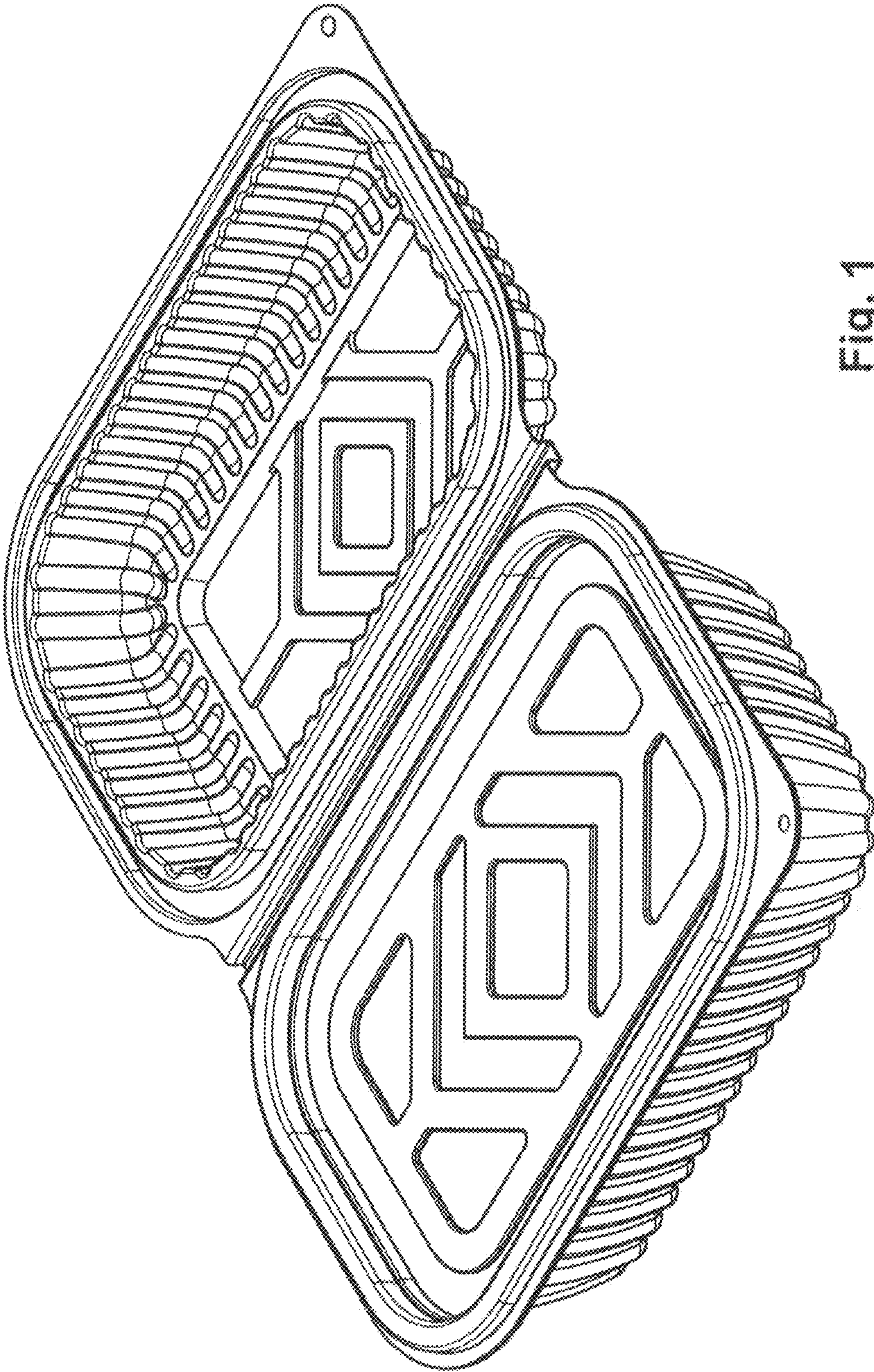

Fig. 1

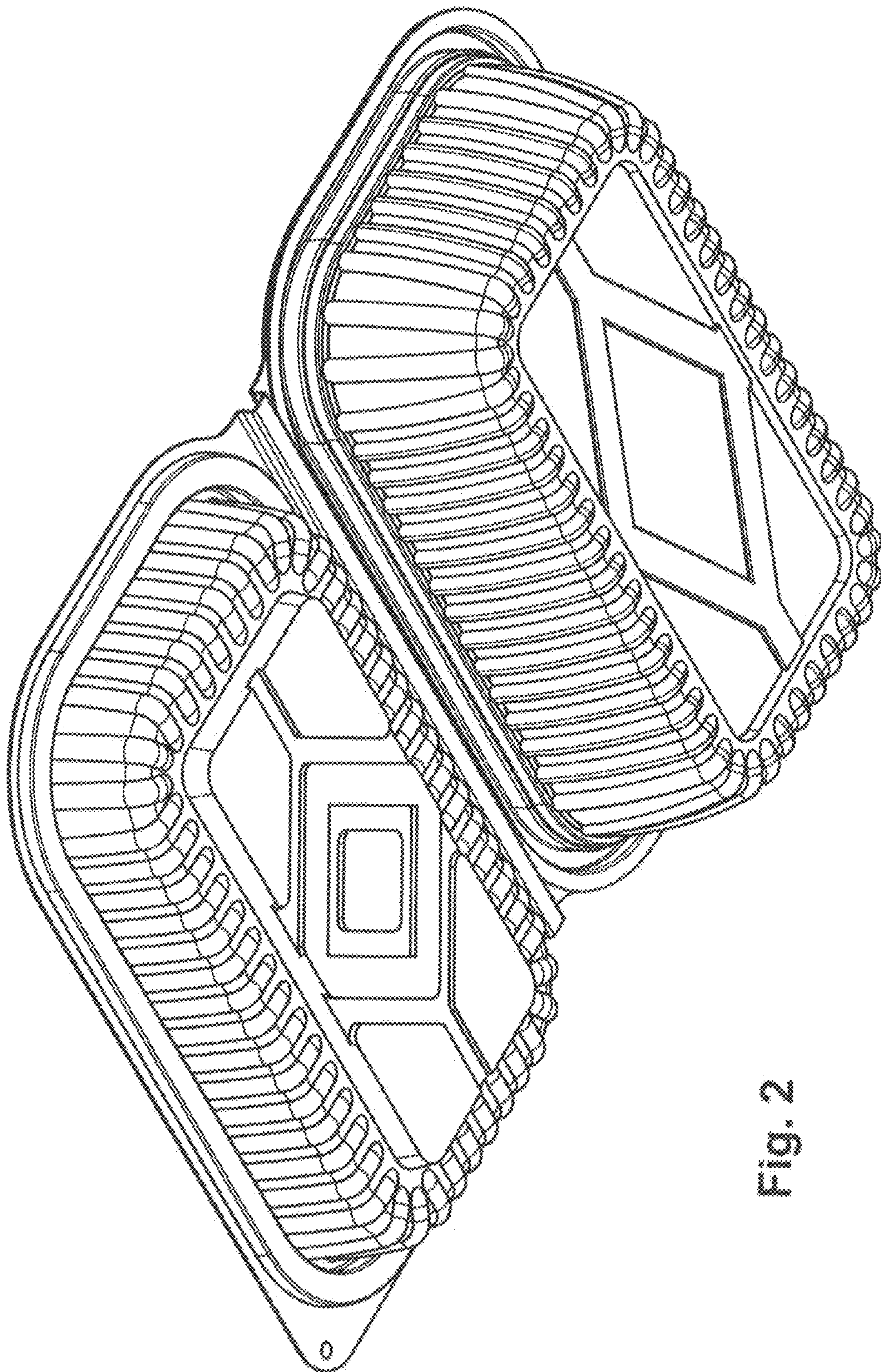

Fig. 2

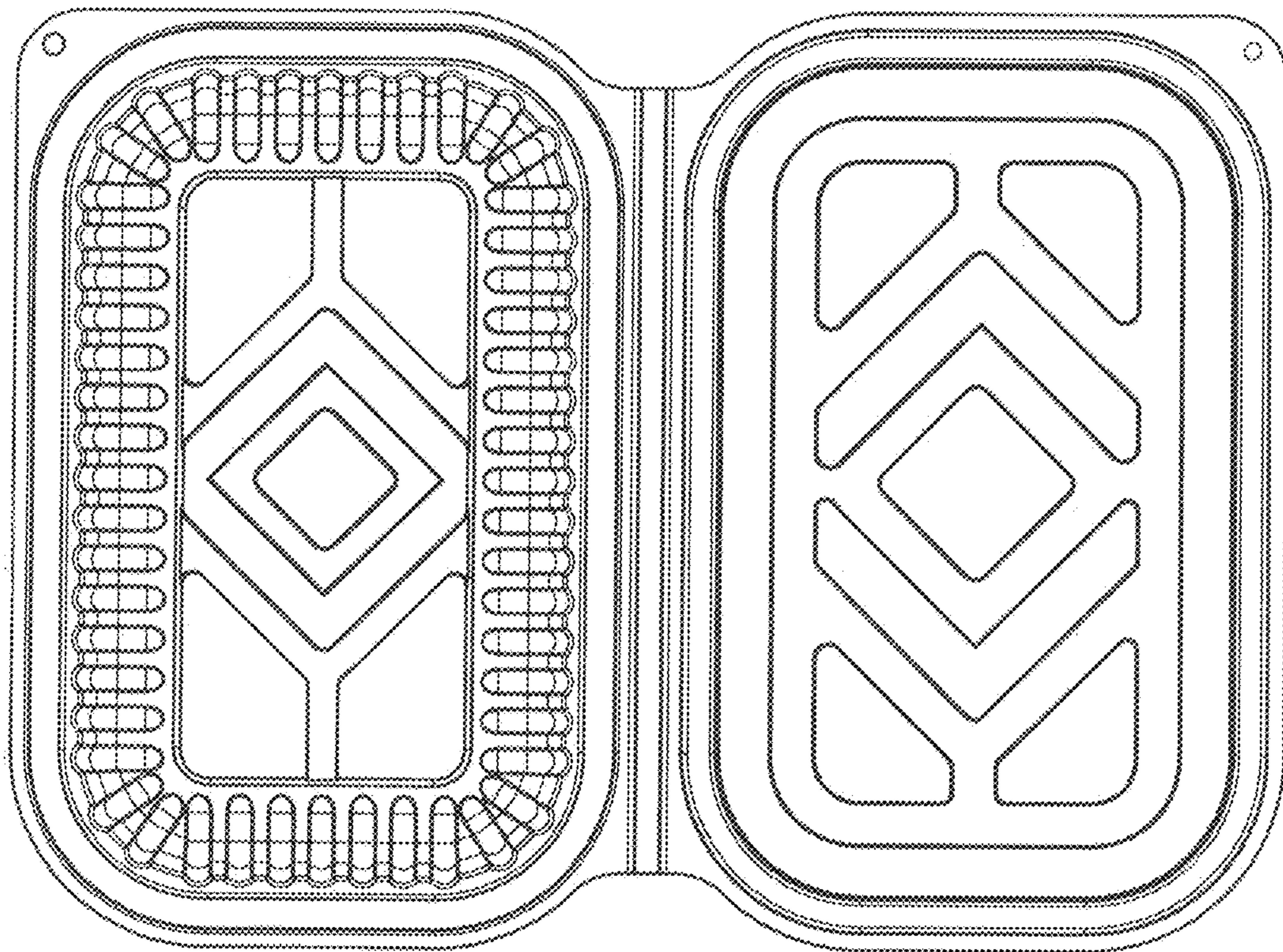

Fig. 3

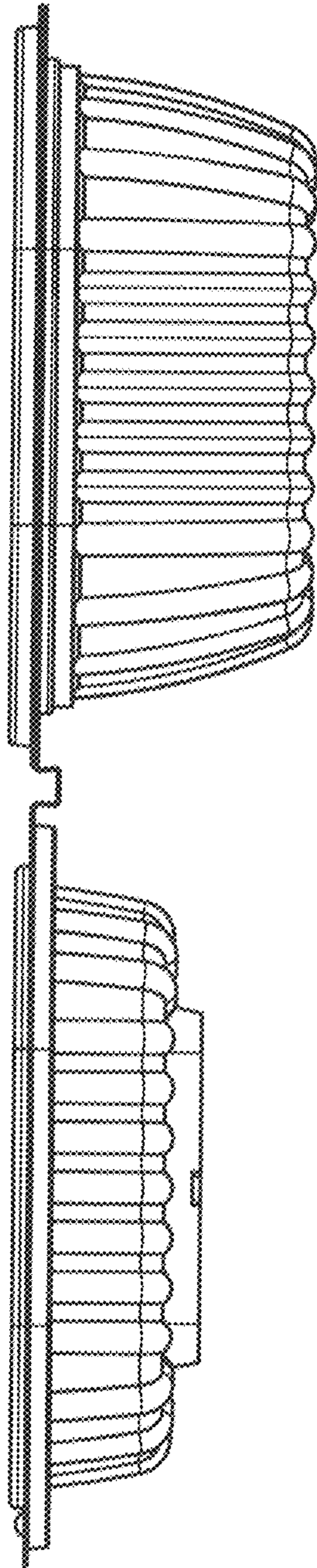

Fig. 4

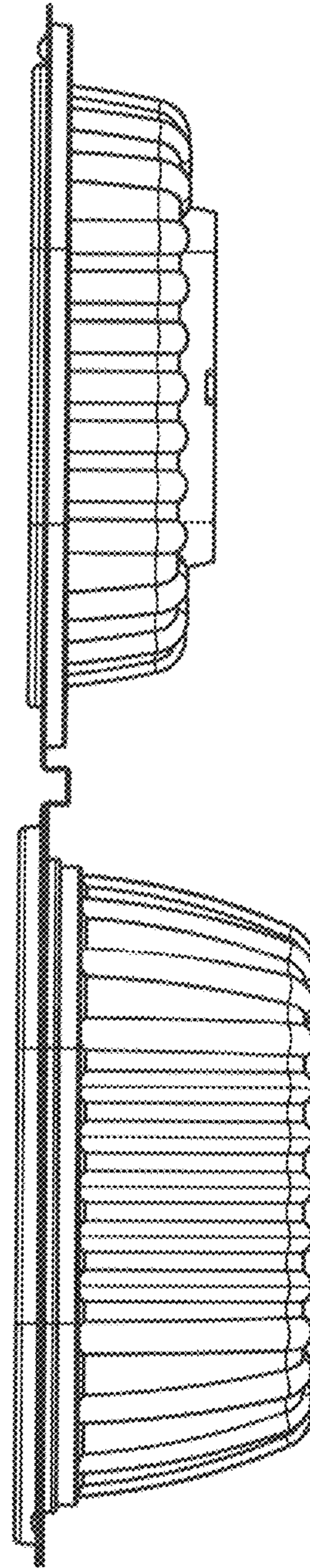

Fig. 5

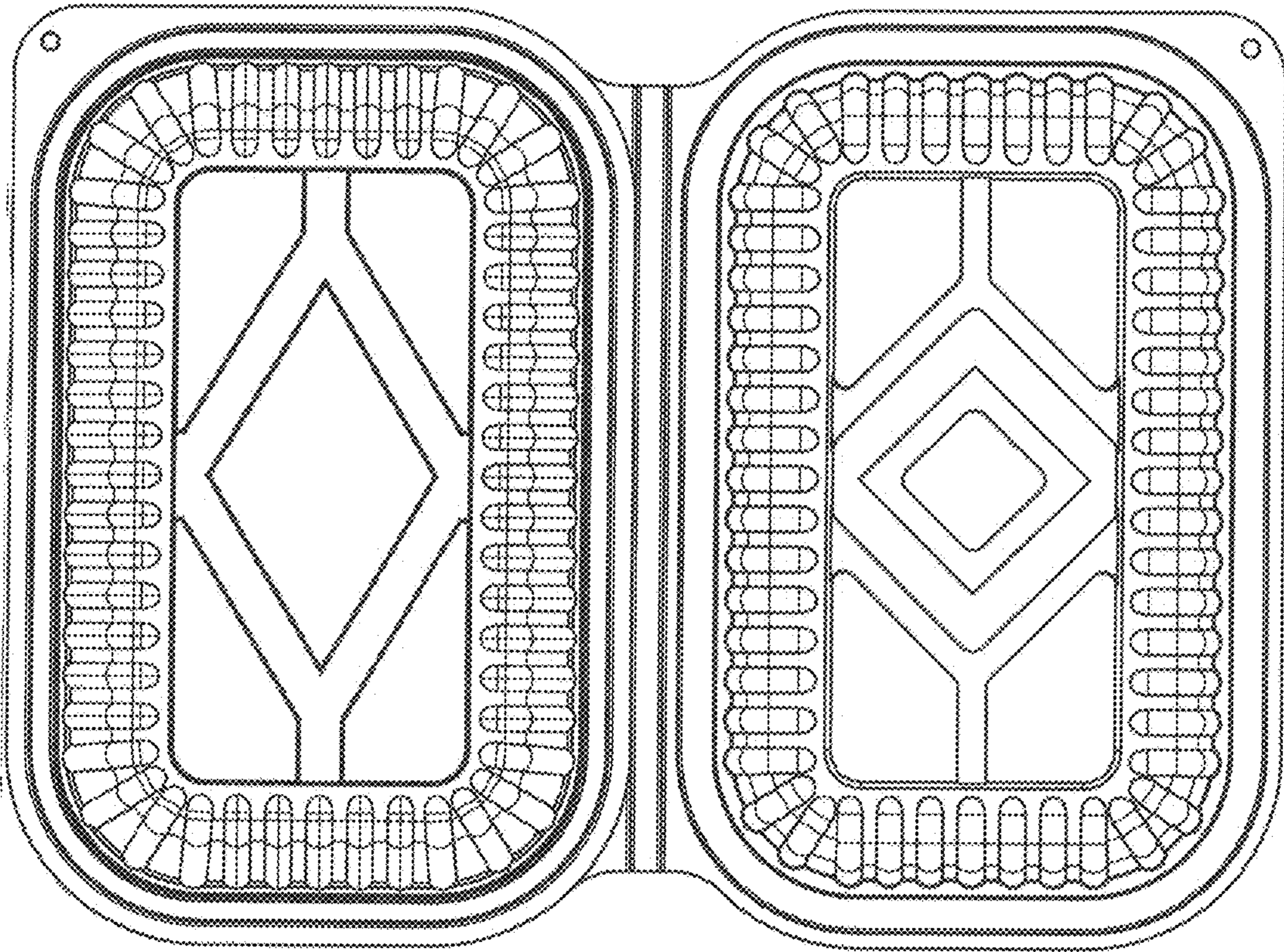

Fig. 6

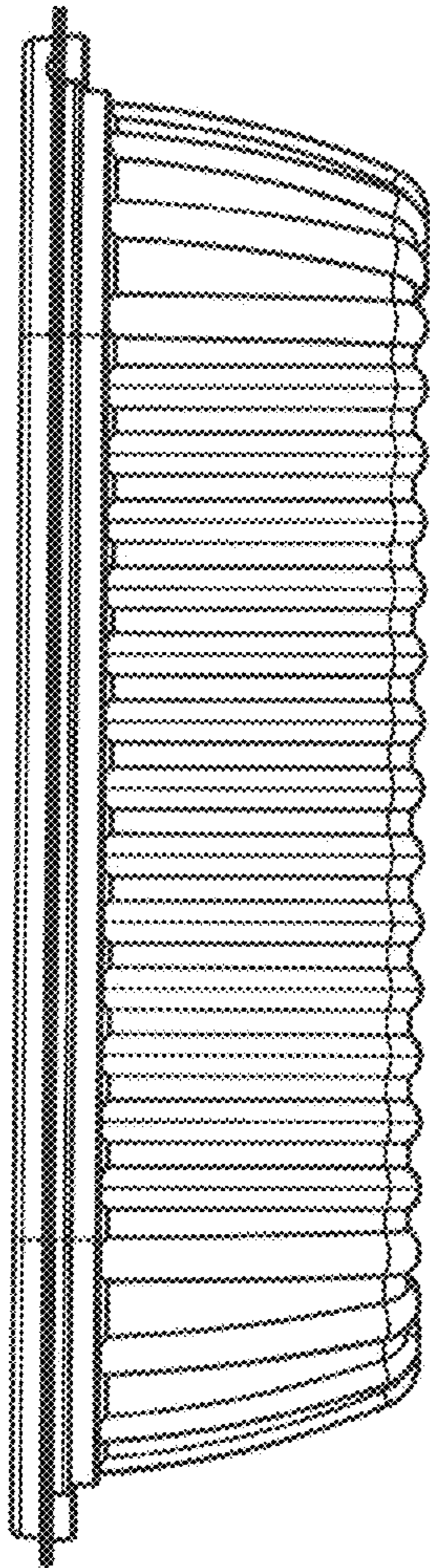

Fig. 7

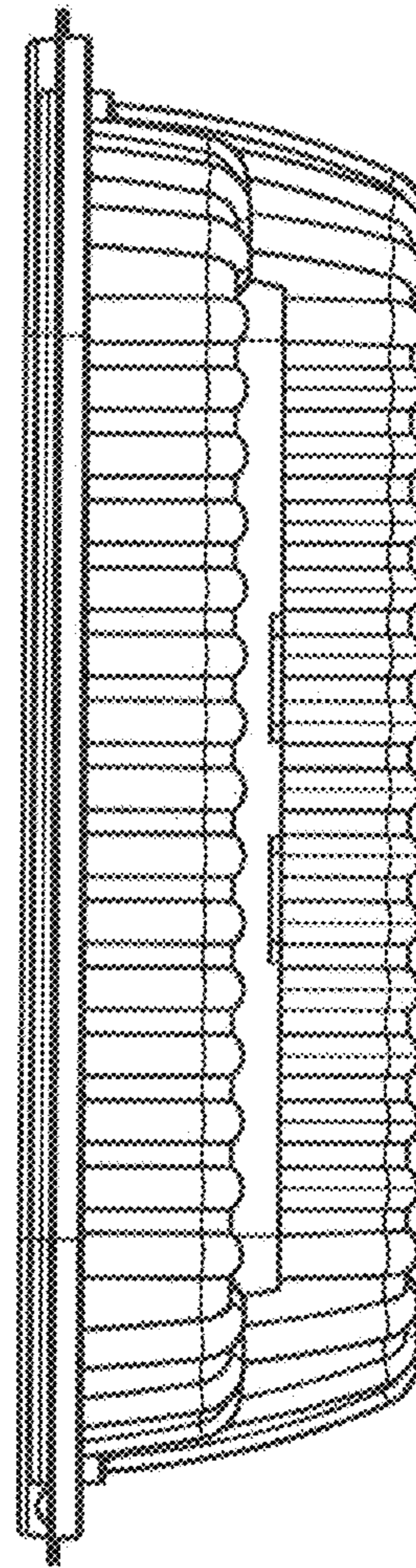

Fig. 8

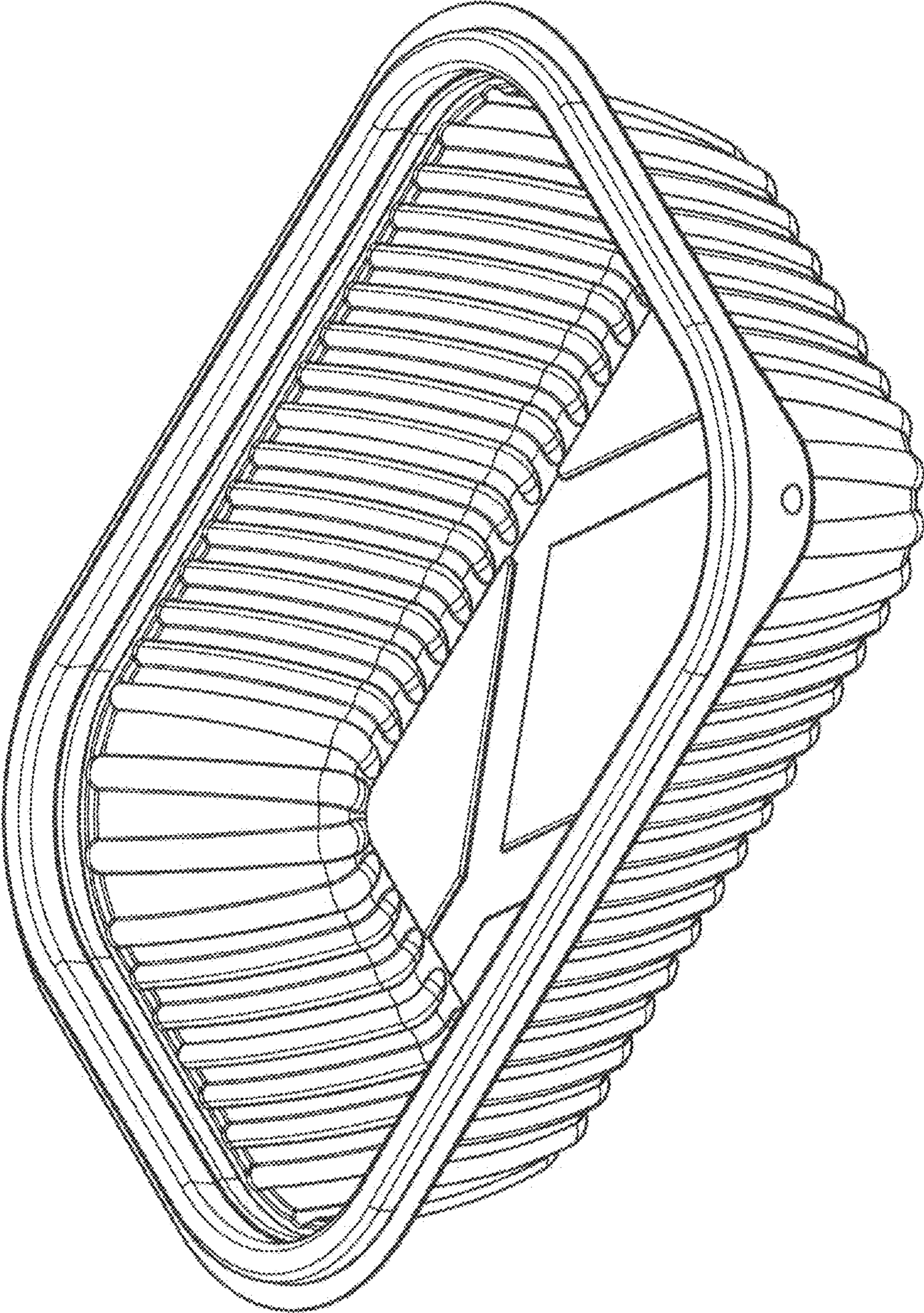

Fig. 9

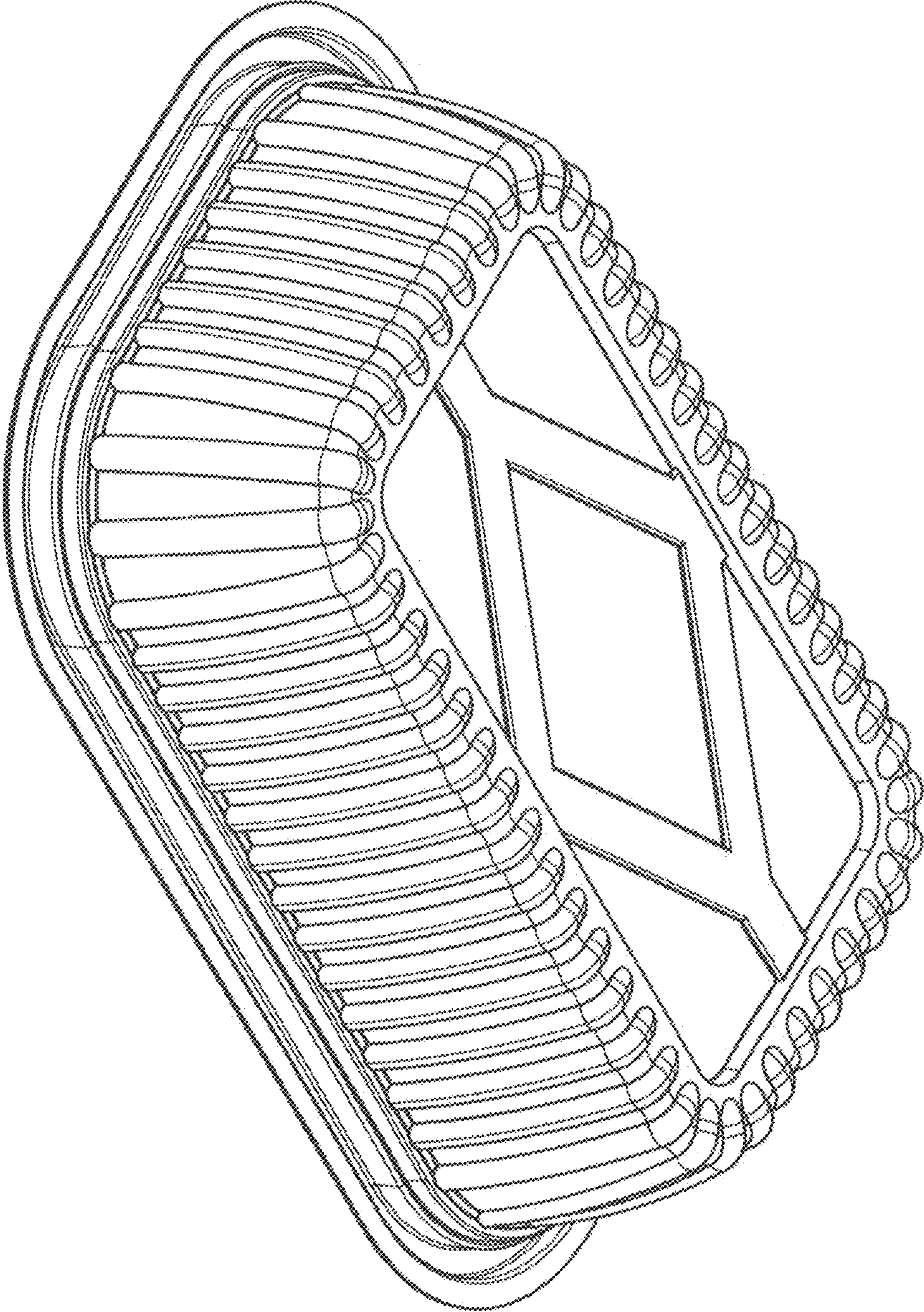

Fig. 10

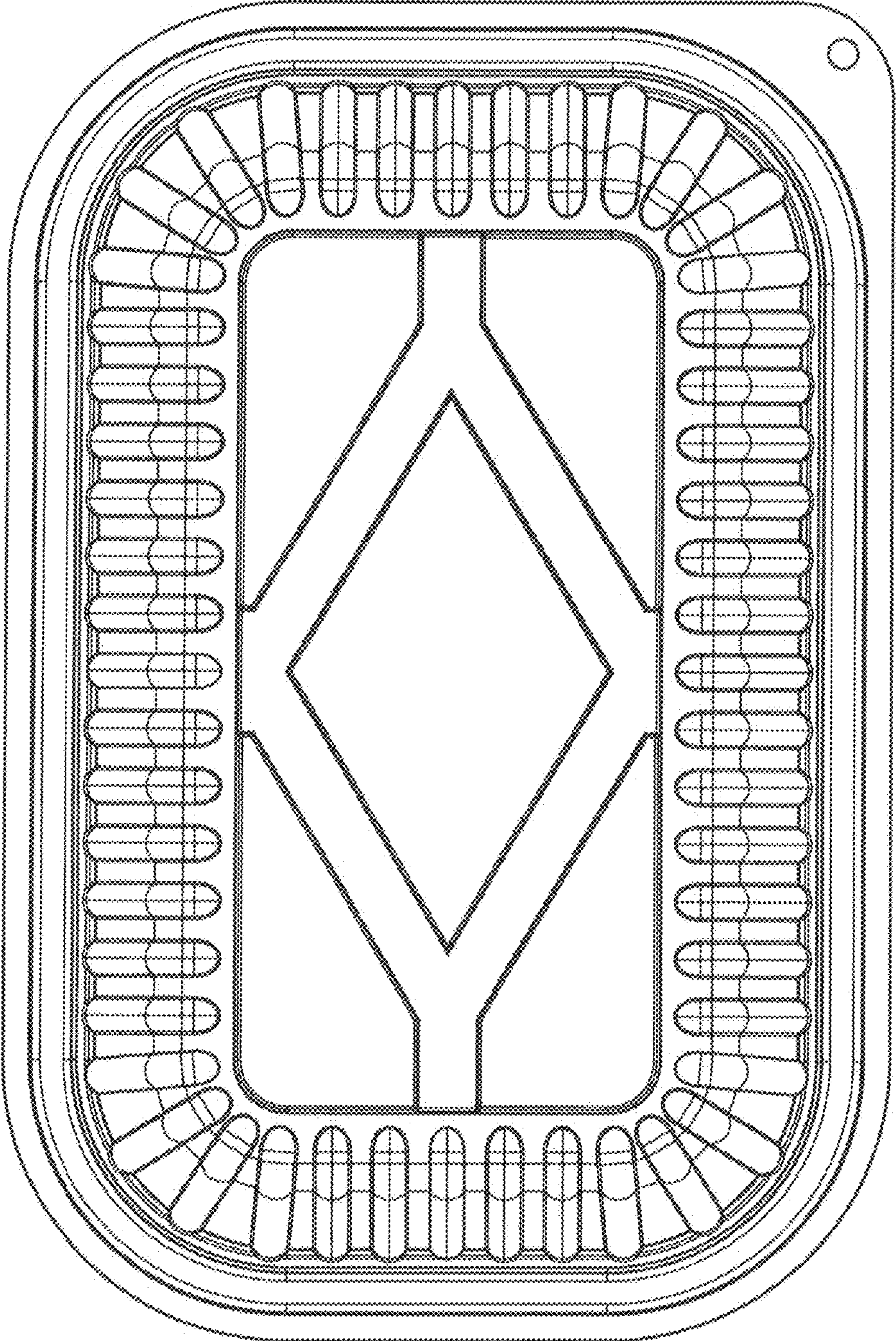

Fig. 11

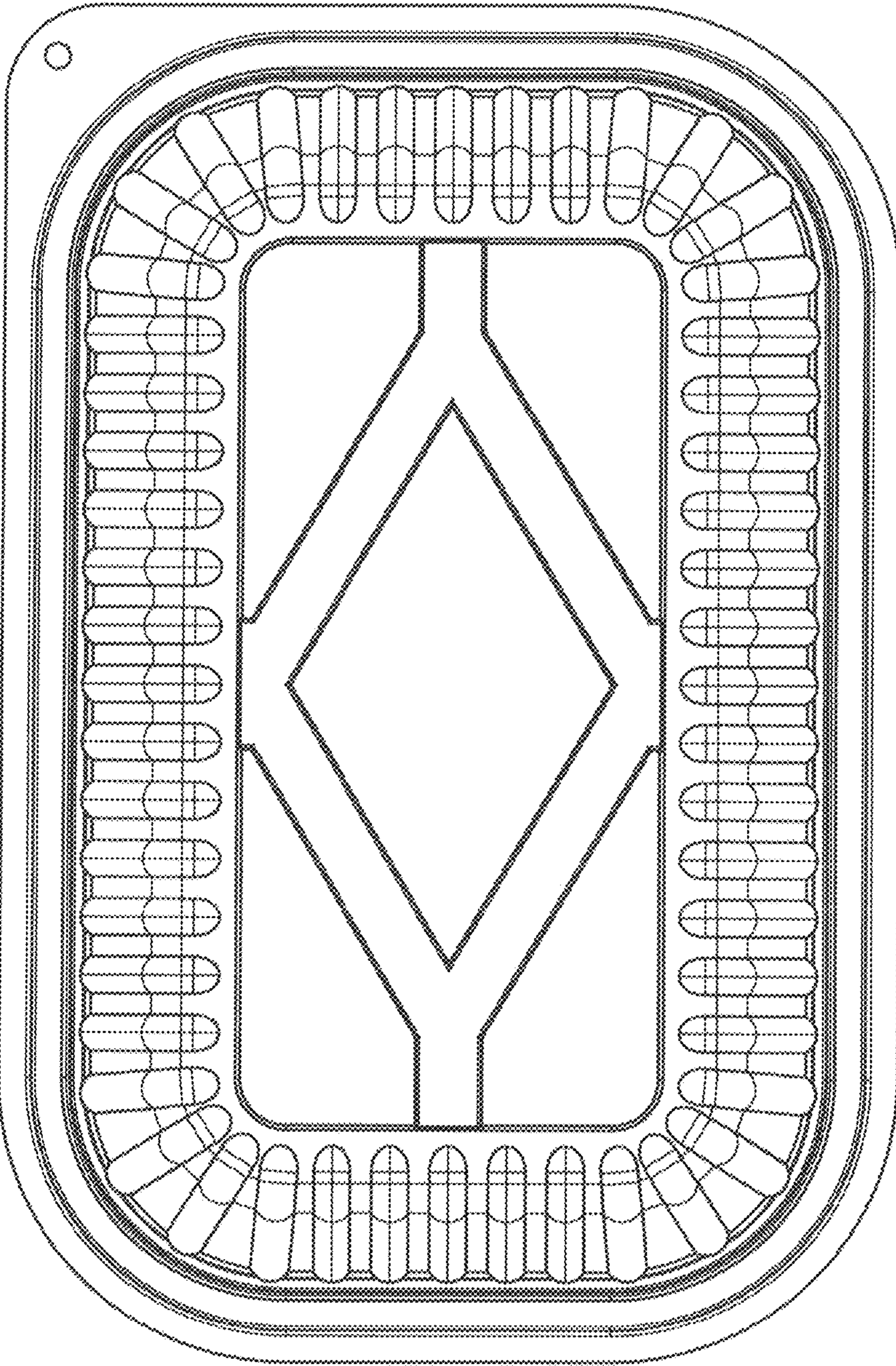

Fig. 12

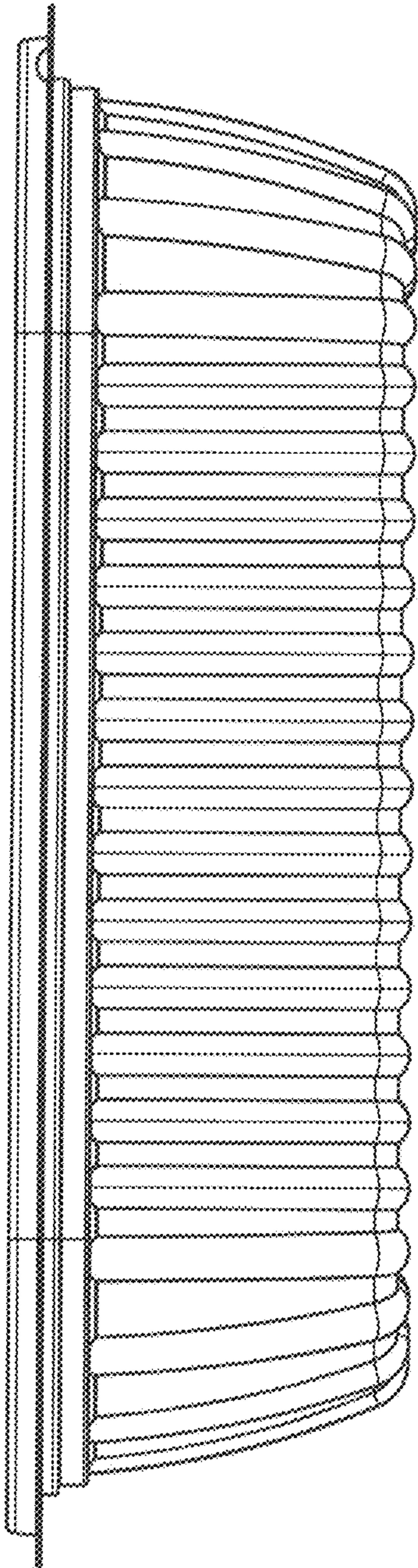

Fig. 13

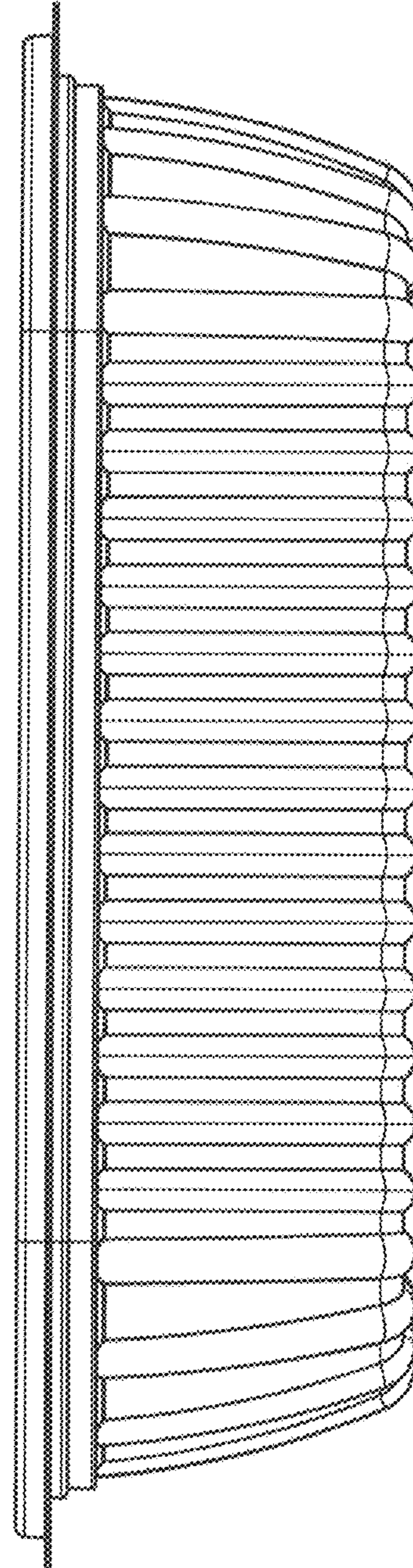

Fig. 14

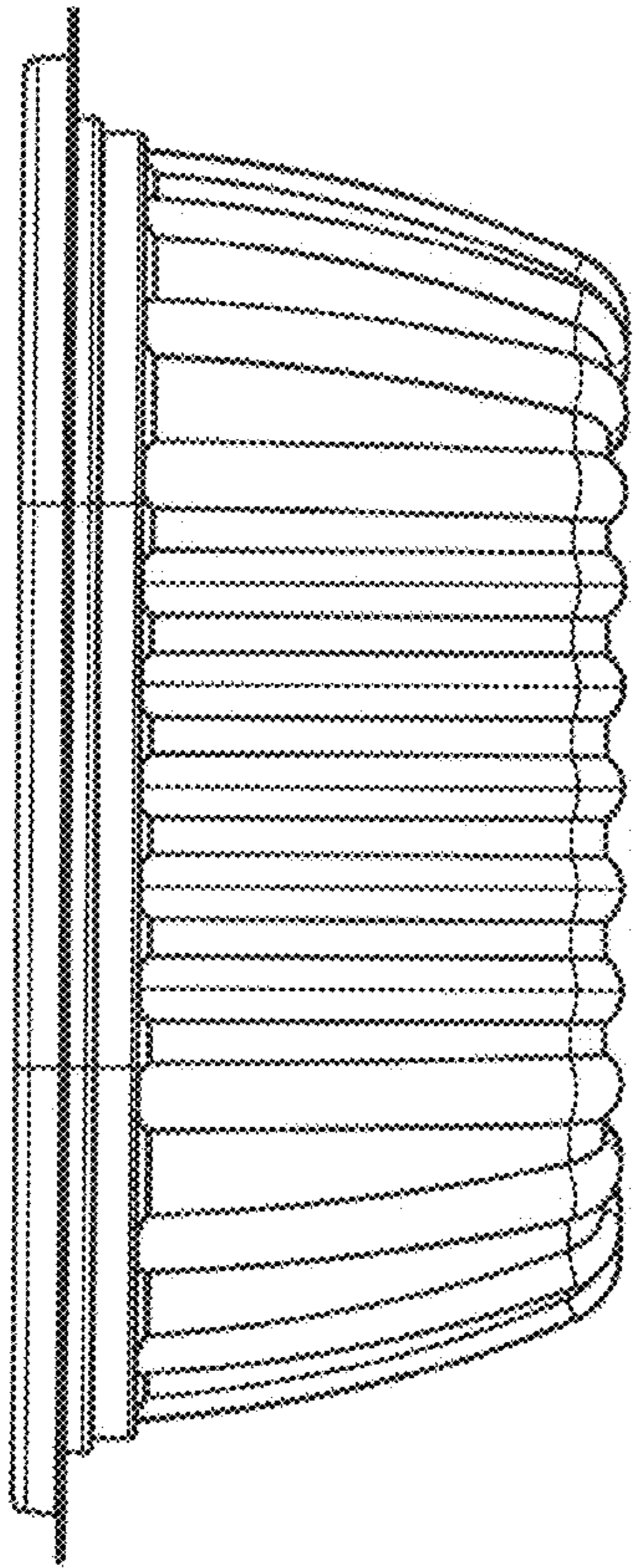

Fig. 15

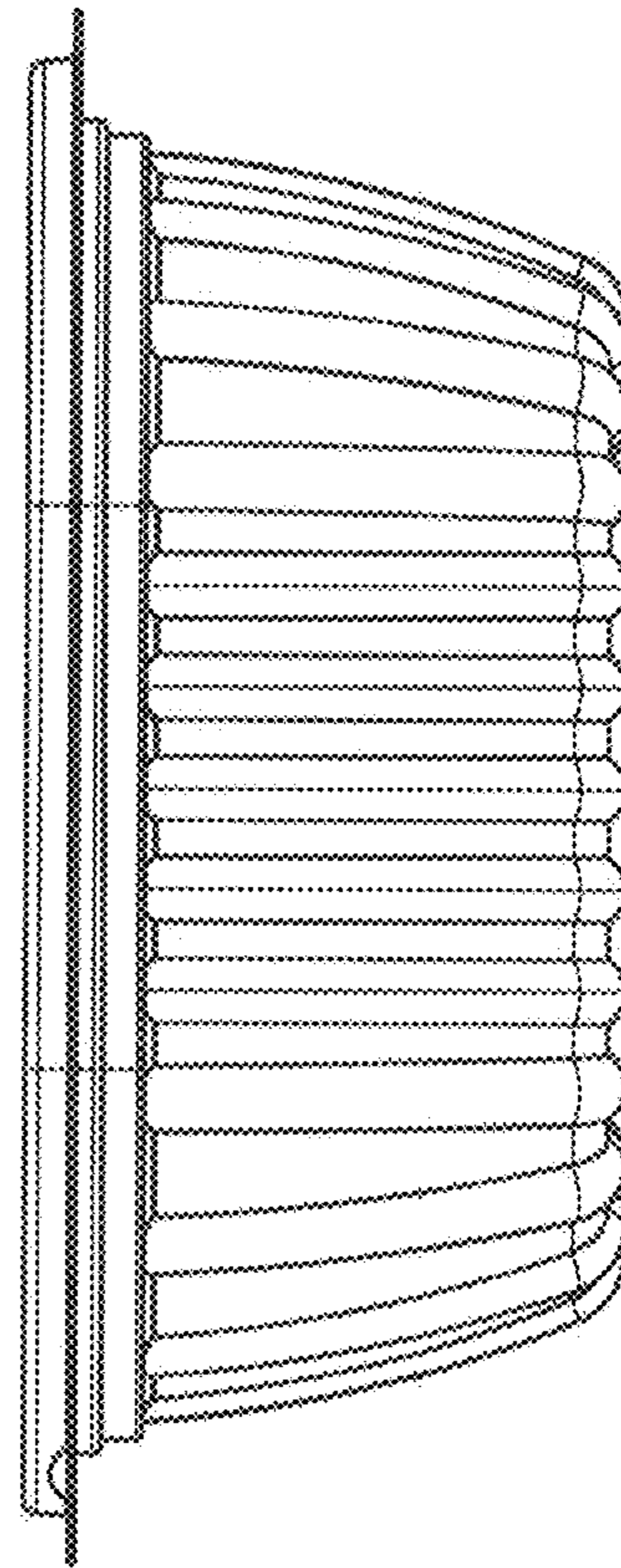

Fig. 16

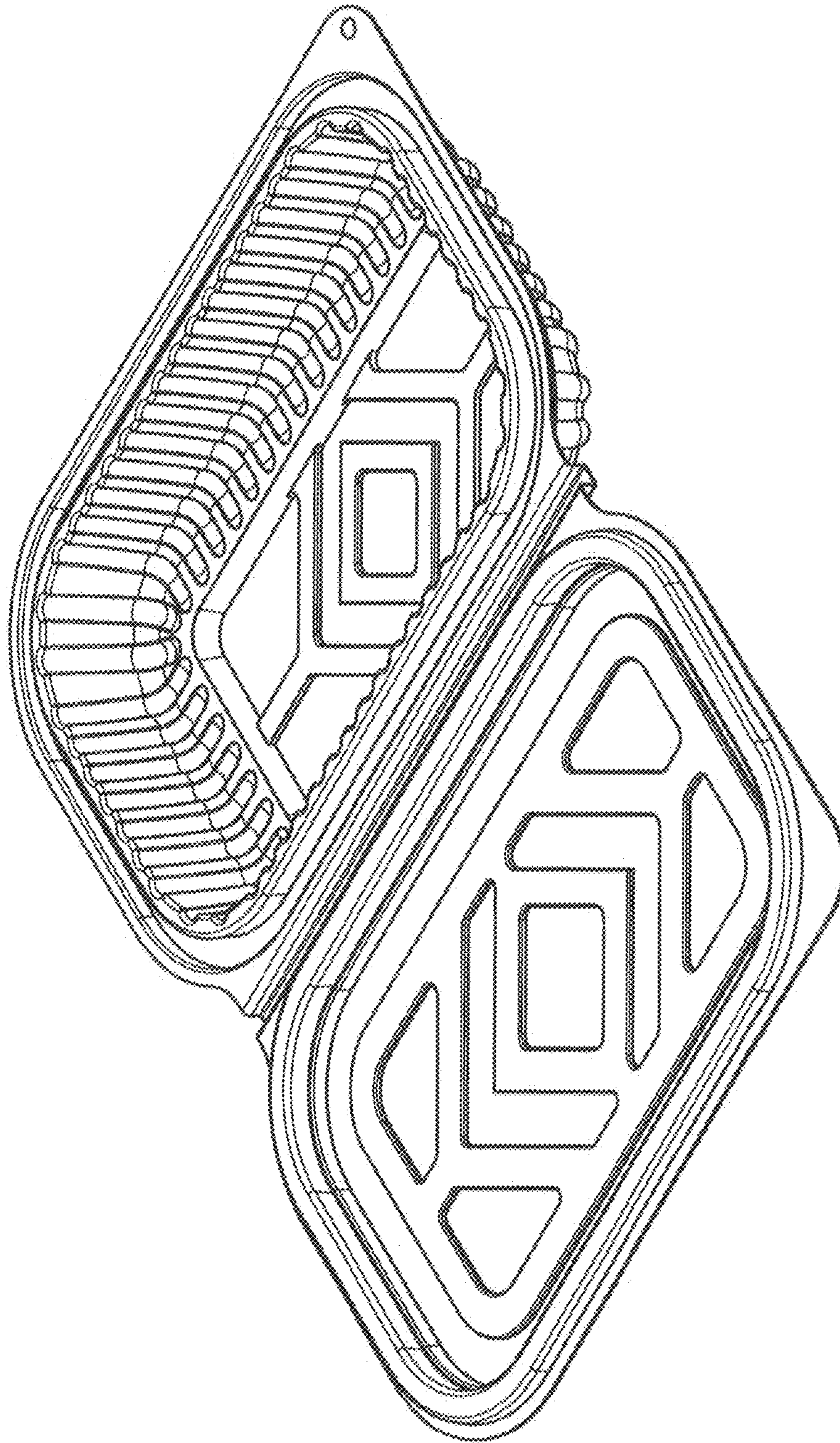

Fig. 17

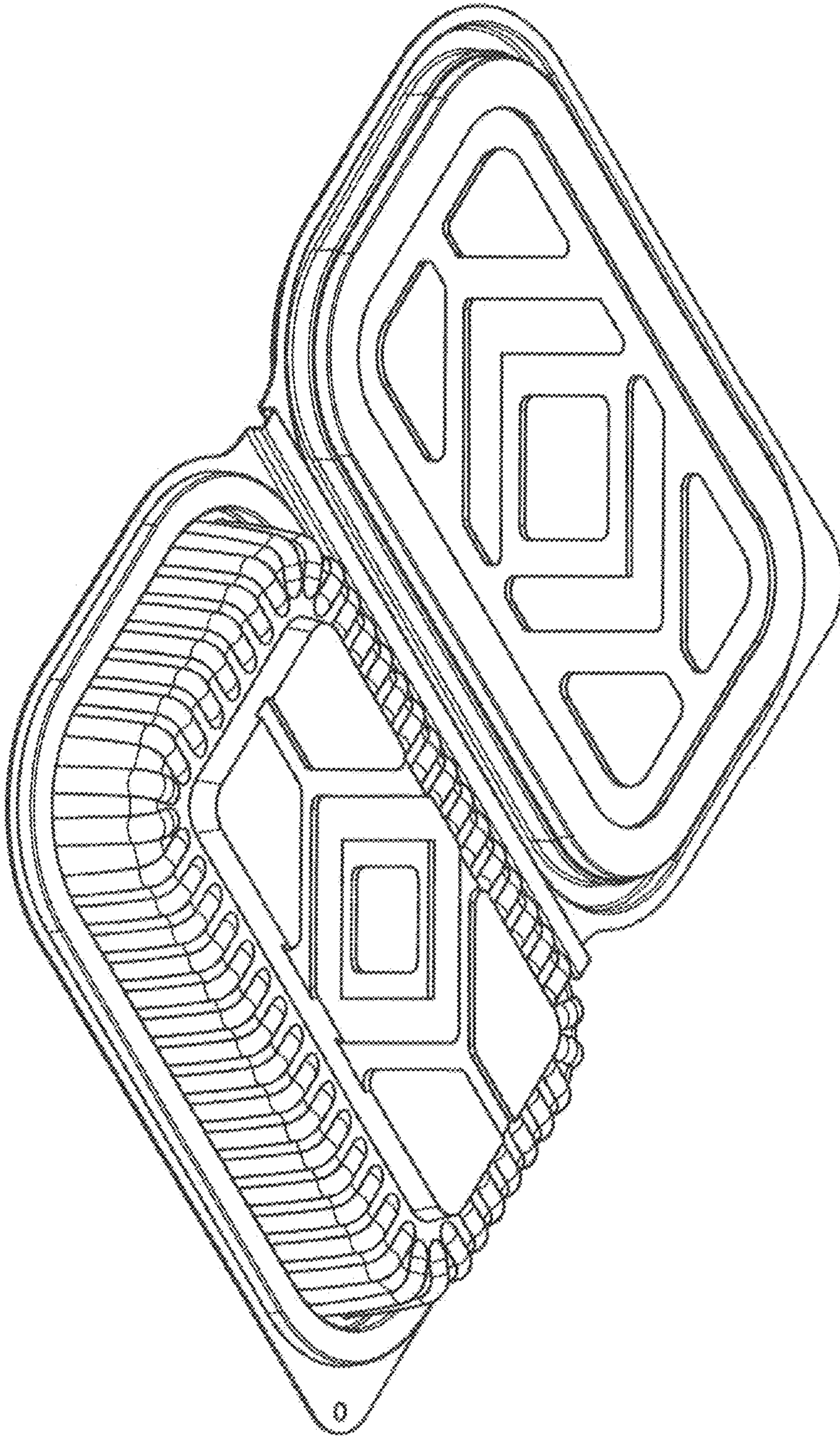

Fig. 18

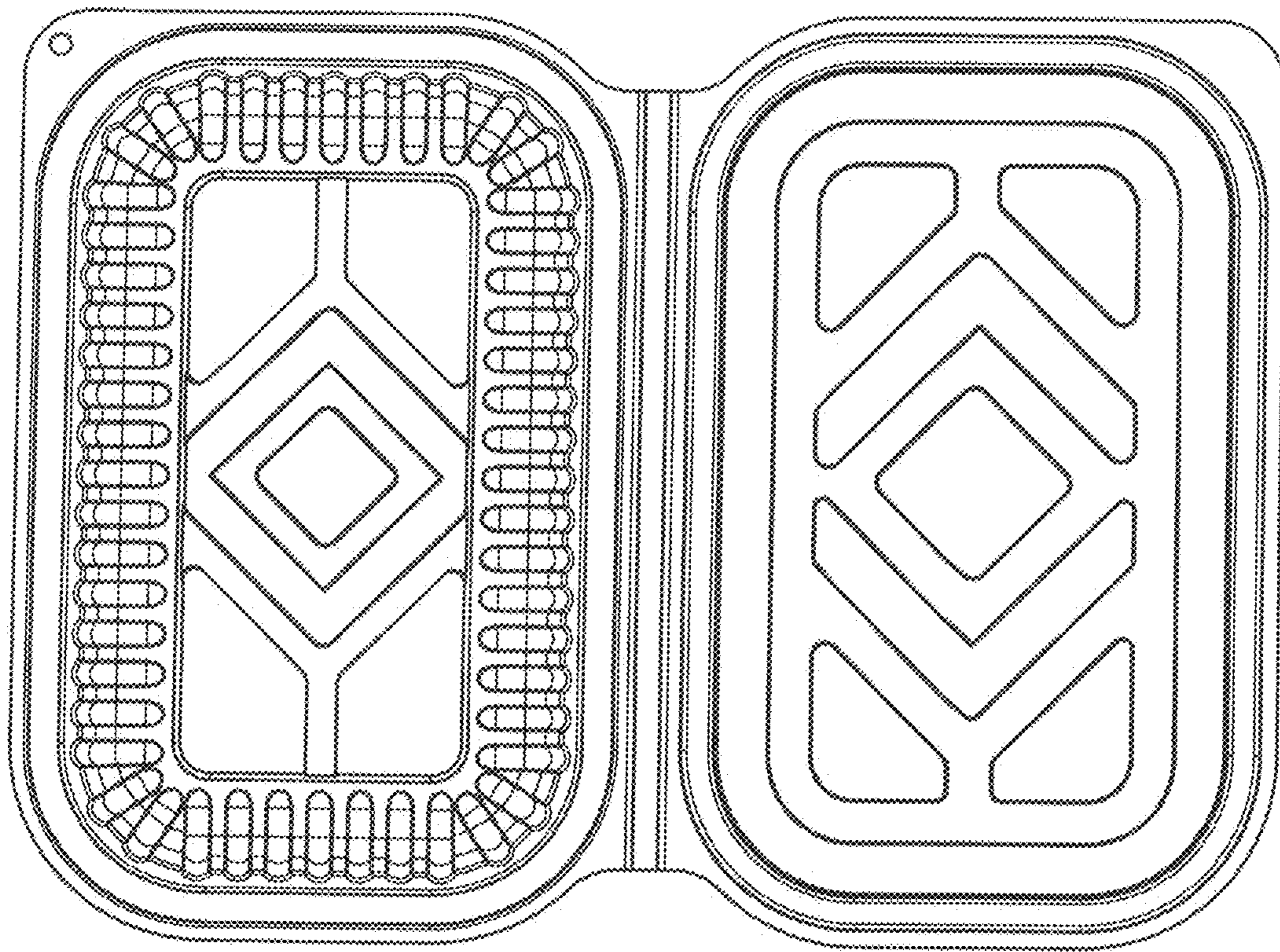

Fig. 19

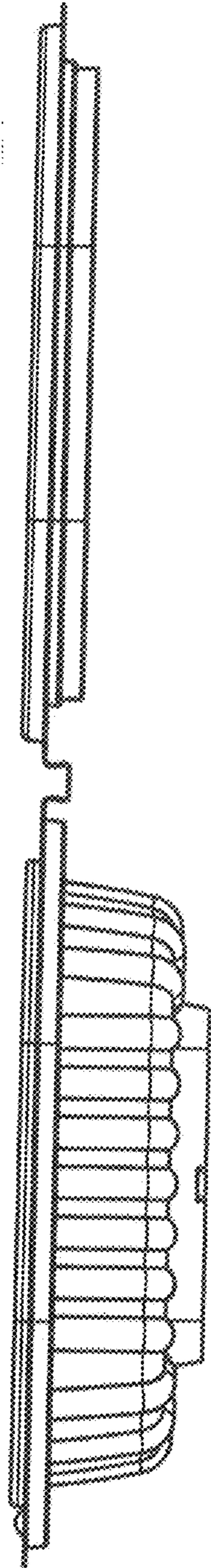

Fig. 20

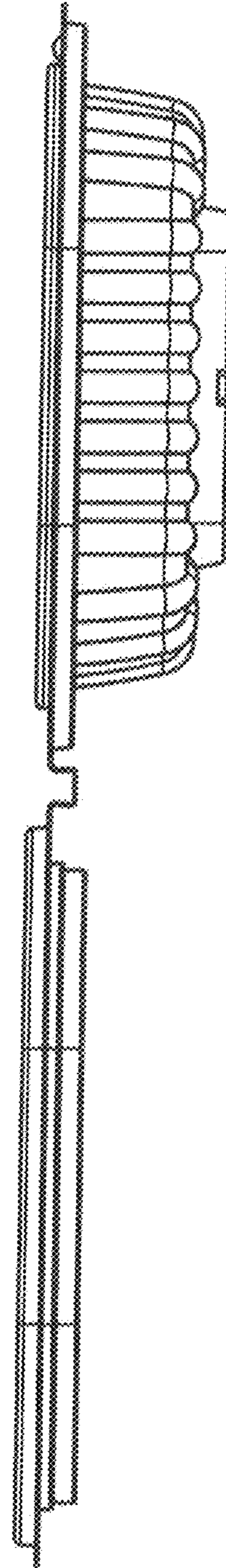

Fig. 21

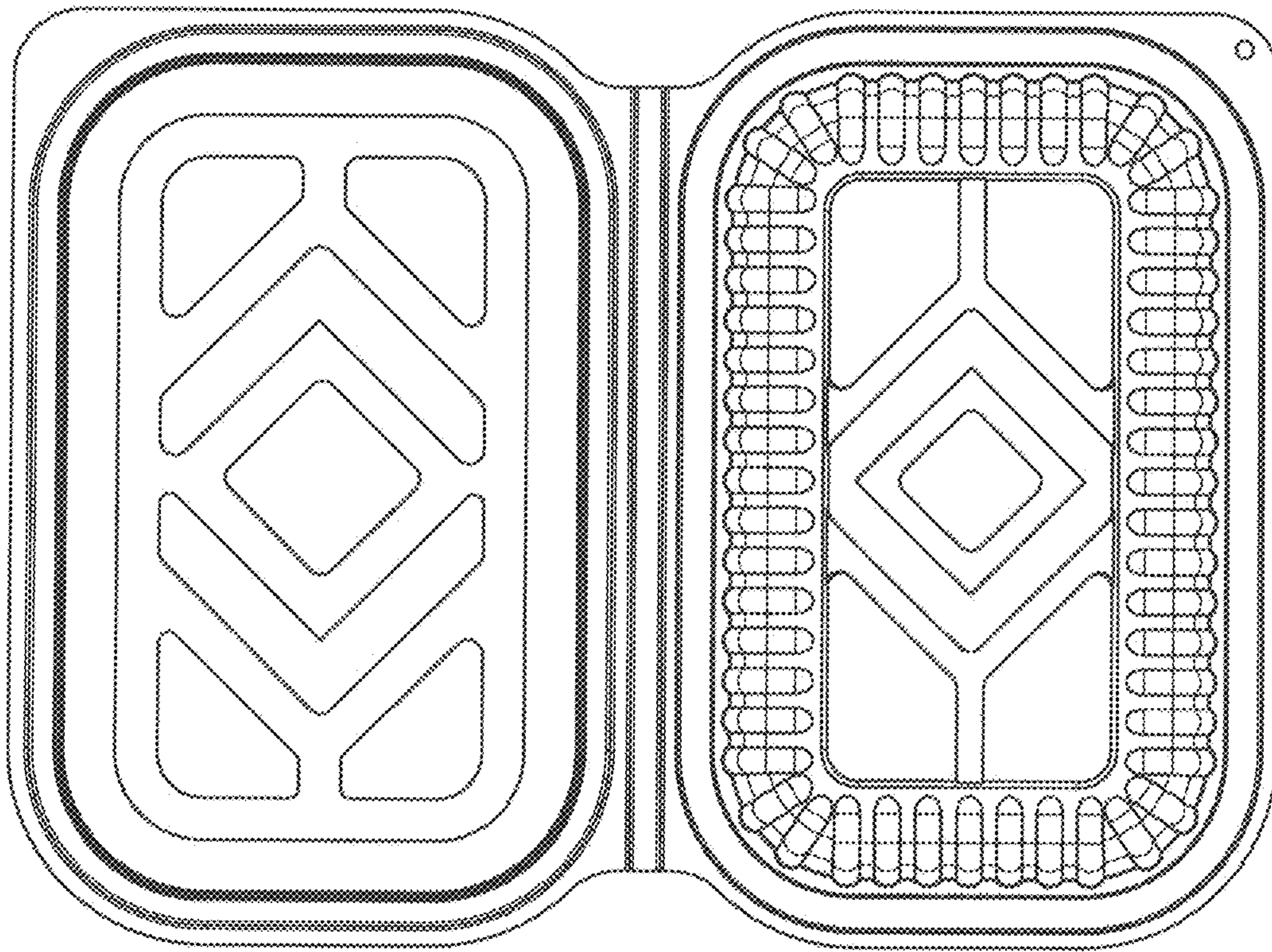

Fig. 22

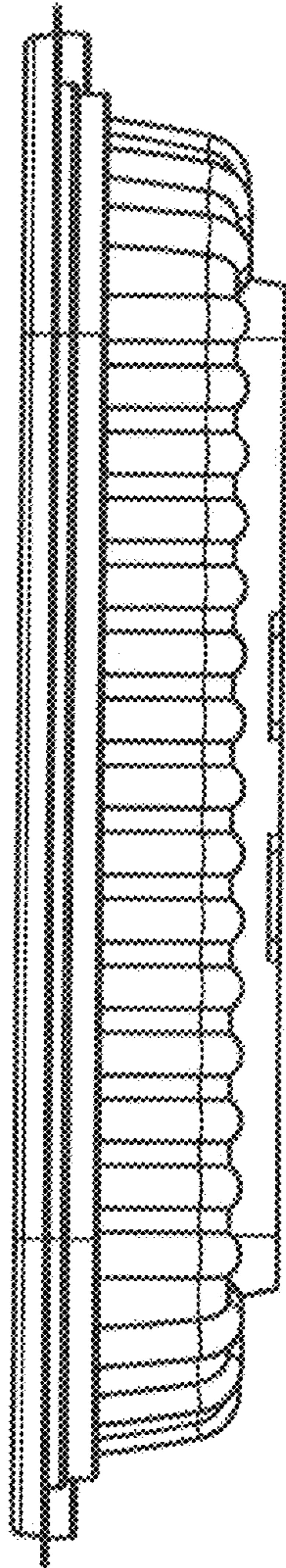

Fig. 23

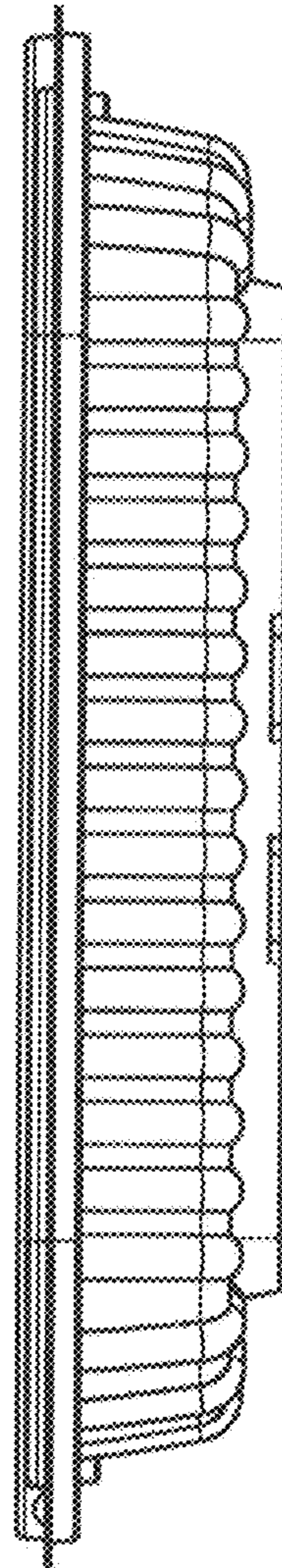

Fig. 24