



US00D781693S

(12) **United States Design Patent**
Roan et al.

(10) **Patent No.:** **US D781,693 S**
(45) **Date of Patent:** **** Mar. 21, 2017**

(54) **CARPET SAMPLE HOLDER**

(71) Applicant: **Mohawk Carpet Distribution, Inc.**,
Calhoun, GA (US)

(72) Inventors: **Joseph Roan**, Media, PA (US); **Ivan Letinic**, Manalapan, NJ (US); **Jacob Donadee**, Philadelphia, PA (US); **Gregg Hlade**, West Deptford, PA (US); **Sean Monahan**, Audobon, NJ (US); **Owen McCormick**, Philadelphia, PA (US)

(73) Assignee: **Mohawk Carpet Distribution, Inc.**,
Calhoun, GA (US)

(**) Term: **14 Years**

(21) Appl. No.: **29/490,435**

(22) Filed: **May 9, 2014**

(51) **LOC (10) Cl.** **08-08**

(52) **U.S. Cl.**
USPC **D8/394; D8/395**

(58) **Field of Classification Search**
USPC D8/394-396, 72; D19/56, 65;
D32/60-64; D28/40; 24/67.3
CPC . D06F 55/00; A44D 2203/00; A61B 17/0664;
A61B 17/04; A61B 17/1265; A43D
79/00; A41B 3/08; A41F 15/02; A62F
2/0063

See application file for complete search history.

(56) **References Cited**

U.S. PATENT DOCUMENTS

D237,104 S * 10/1975 Fisher D12/400
4,166,494 A * 9/1979 Utting A47H 1/00
16/97

D261,311 S * 10/1981 Schmidt D25/124
D310,775 S * 9/1990 Ruonala D8/377
D488,055 S * 4/2004 Ter Braak D8/377
D548,063 S * 8/2007 Allen D8/377
D693,484 S * 11/2013 Krieger D25/119
D732,702 S * 6/2015 Gallien D25/119
D745,192 S * 12/2015 Suciu D25/119
D755,041 S * 5/2016 Weldon D8/377

* cited by examiner

Primary Examiner — John Windmuller

(74) *Attorney, Agent, or Firm* — Alston & Bird LLP

(57) **CLAIM**

The ornamental design for a carpet sample holder, as shown and described.

DESCRIPTION

FIG. 1 is a perspective view of a carpet sample holder according to our invention with sample materials illustrated in broken lines;

FIG. 2 is a perspective view thereof without sample materials illustrated in broken lines;

FIG. 3 is a front plan view thereof;

FIG. 4 is a rear plan view thereof;

FIG. 5 is a right side view thereof;

FIG. 6 is a left side view thereof;

FIG. 7 is a top view thereof; and,

FIG. 8 is a bottom view thereof.

The broken lines illustrate environmental structure and form no part of the claimed design.

1 Claim, 5 Drawing Sheets

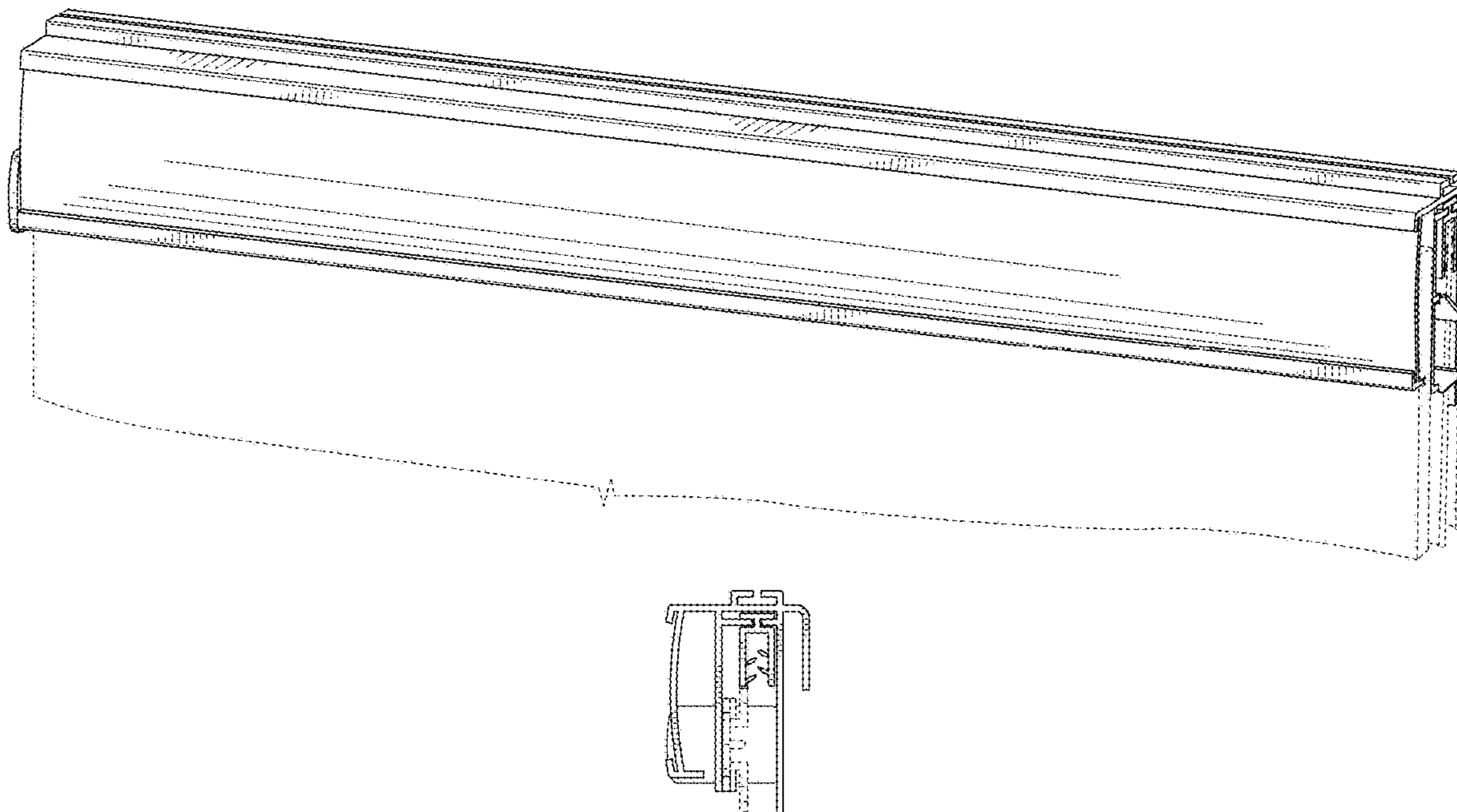

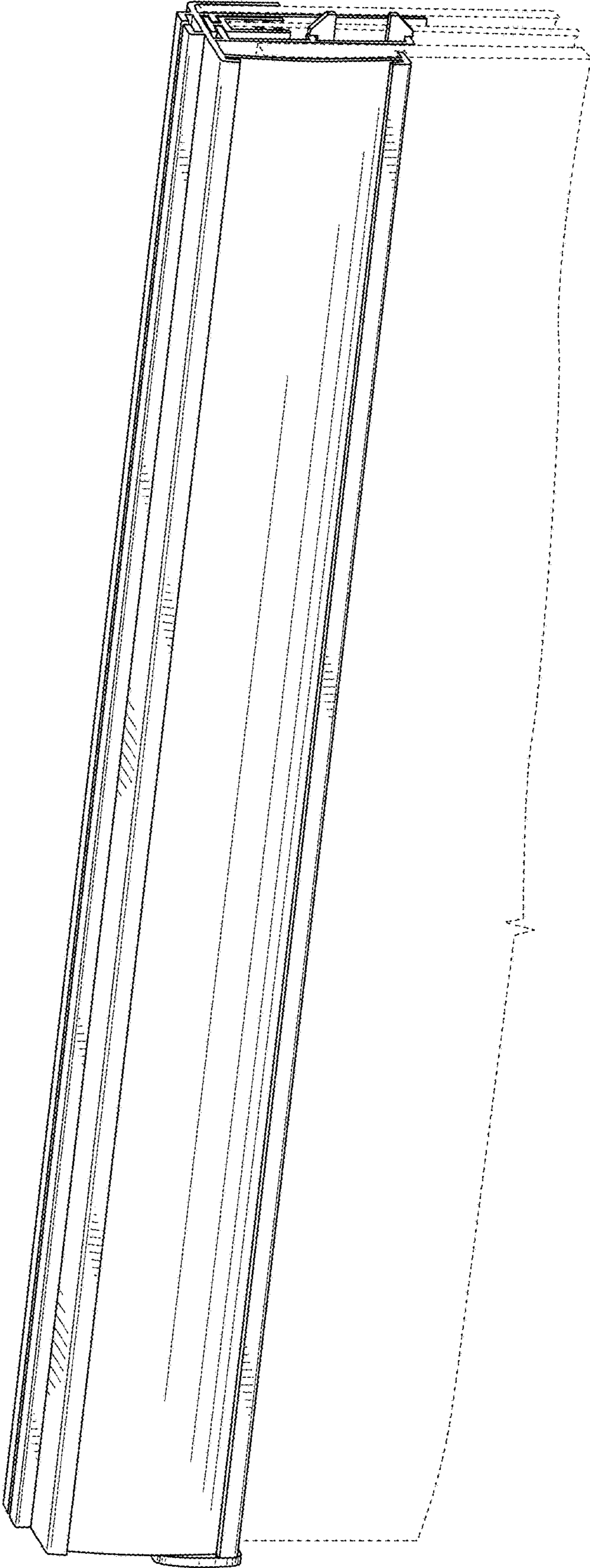

FIG. 1

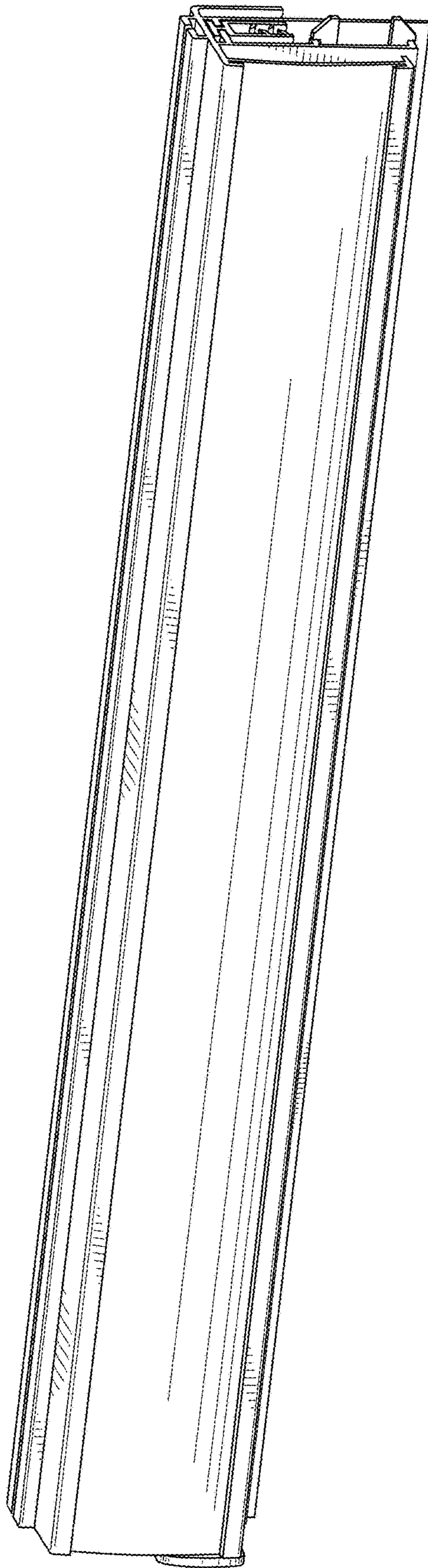

FIG. 2

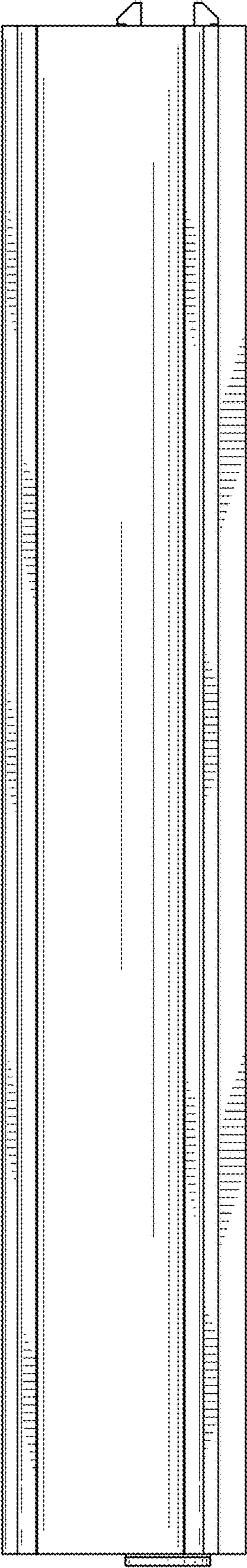

FIG. 3

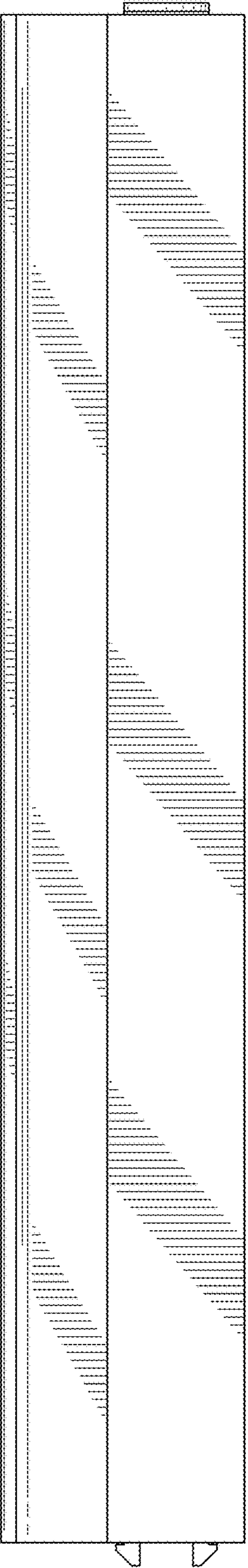

FIG. 4

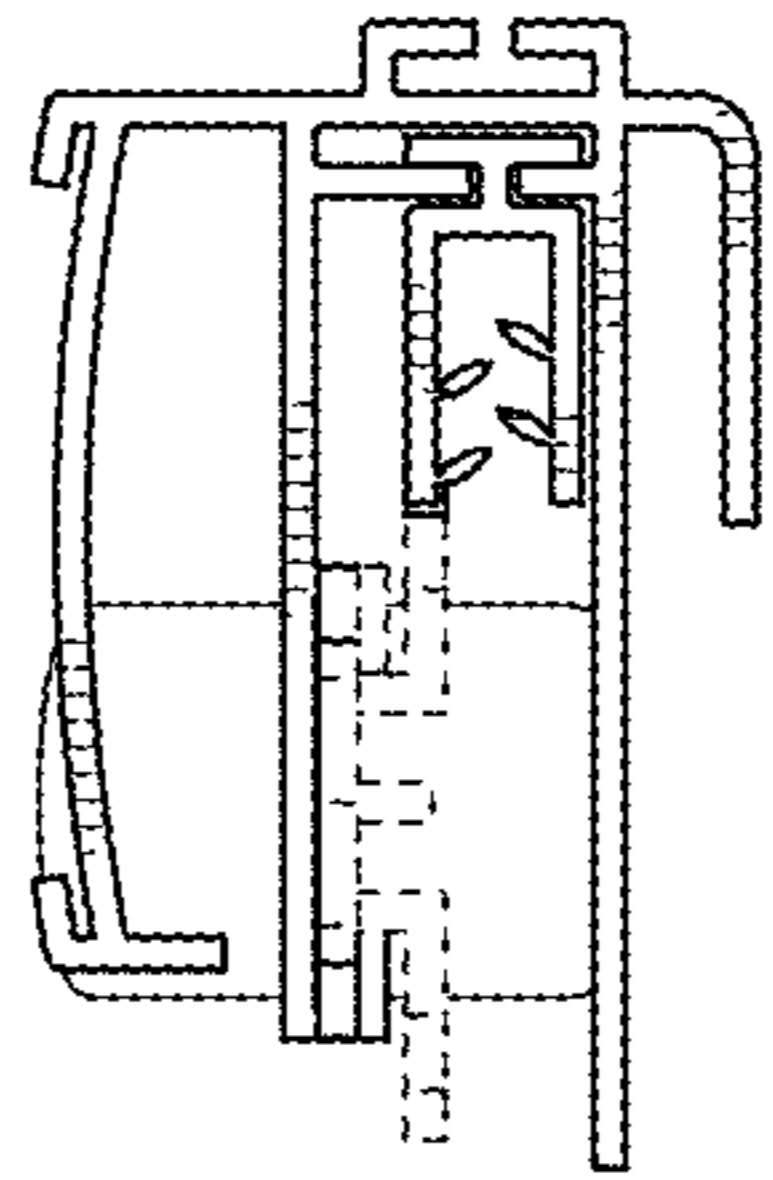

FIG. 5

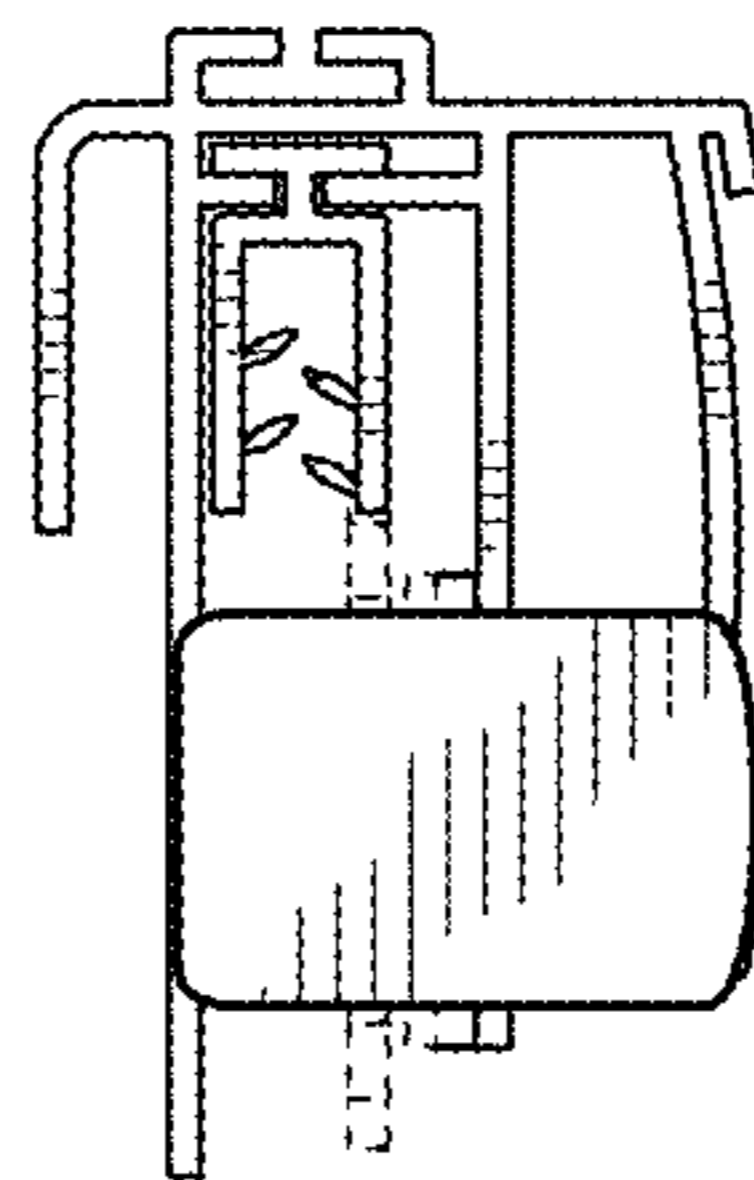

FIG. 6

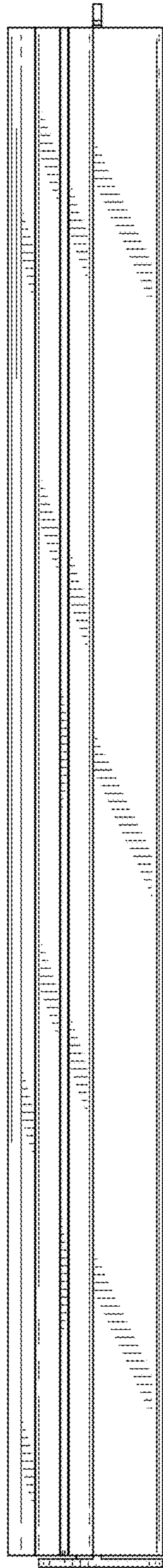

FIG. 7

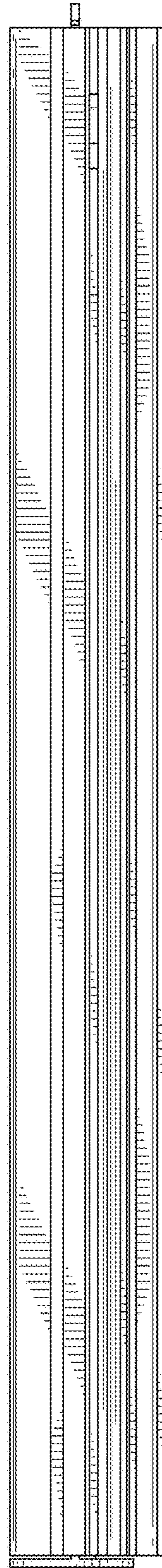

FIG. 8