



US00D781671S

(12) **United States Design Patent**  
**Berger**

(10) **Patent No.:** **US D781,671 S**  
(45) **Date of Patent:** **\*\* Mar. 21, 2017**

(54) **BOTTLE ORGANIZER**  
(71) Applicant: **Andy L Berger**, Woodridge, IL (US)  
(72) Inventor: **Andy L Berger**, Woodridge, IL (US)  
(\*\*) Term: **15 Years**  
(21) Appl. No.: **29/540,139**  
(22) Filed: **Sep. 21, 2015**  
(51) **LOC (10) Cl.** ..... **06-04**  
(52) **U.S. Cl.**  
USPC ..... **D7/704**  
(58) **Field of Classification Search**  
USPC ..... D7/701-708, 600.1-600.4; D3/306, 310,  
D3/313; D6/676.5, 677.5, 678.4, 680.3,  
D6/682.2, 512  
CPC ... A47B 73/00; A47F 5/01; A47J 31/44; A47J  
47/16; B01L 9/06; A21B 3/13; A21B  
5/026; A47G 23/0241; A47G 23/065;  
A47G 23/0616  
See application file for complete search history.

5,207,150 A \* 5/1993 Wellman ..... A21B 5/026  
249/120  
D541,604 S \* 5/2007 Goodman ..... D7/704  
D634,979 S \* 3/2011 Tiemann ..... A47J 47/16  
D7/600.4  
D635,405 S \* 4/2011 Tiemann ..... A47J 31/44  
D7/600.4  
D656,363 S \* 3/2012 Tiemann ..... D7/600.1

\* cited by examiner

*Primary Examiner* — Terry Wallace

(57) **CLAIM**

The ornamental design for a bottle organizer, as shown and described.

**DESCRIPTION**

FIG. 1 is a top perspective view of a bottle organizer showing of my new design;  
FIG. 2 is a bottom perspective view thereof;  
FIG. 3 is a front elevational view thereof;  
FIG. 4 is a rear elevational view thereof;  
FIG. 5 is a left side elevational view thereof;  
FIG. 6 is a right side elevational view thereof;  
FIG. 7 is a bottom plan view thereof; and,  
FIG. 8 is a top plan view thereof.

**1 Claim, 8 Drawing Sheets**

(56) **References Cited**

**U.S. PATENT DOCUMENTS**

1,448,259 A \* 3/1923 Cook ..... A47G 23/0616  
294/143  
4,446,982 A \* 5/1984 Corse ..... A21B 3/13  
220/512

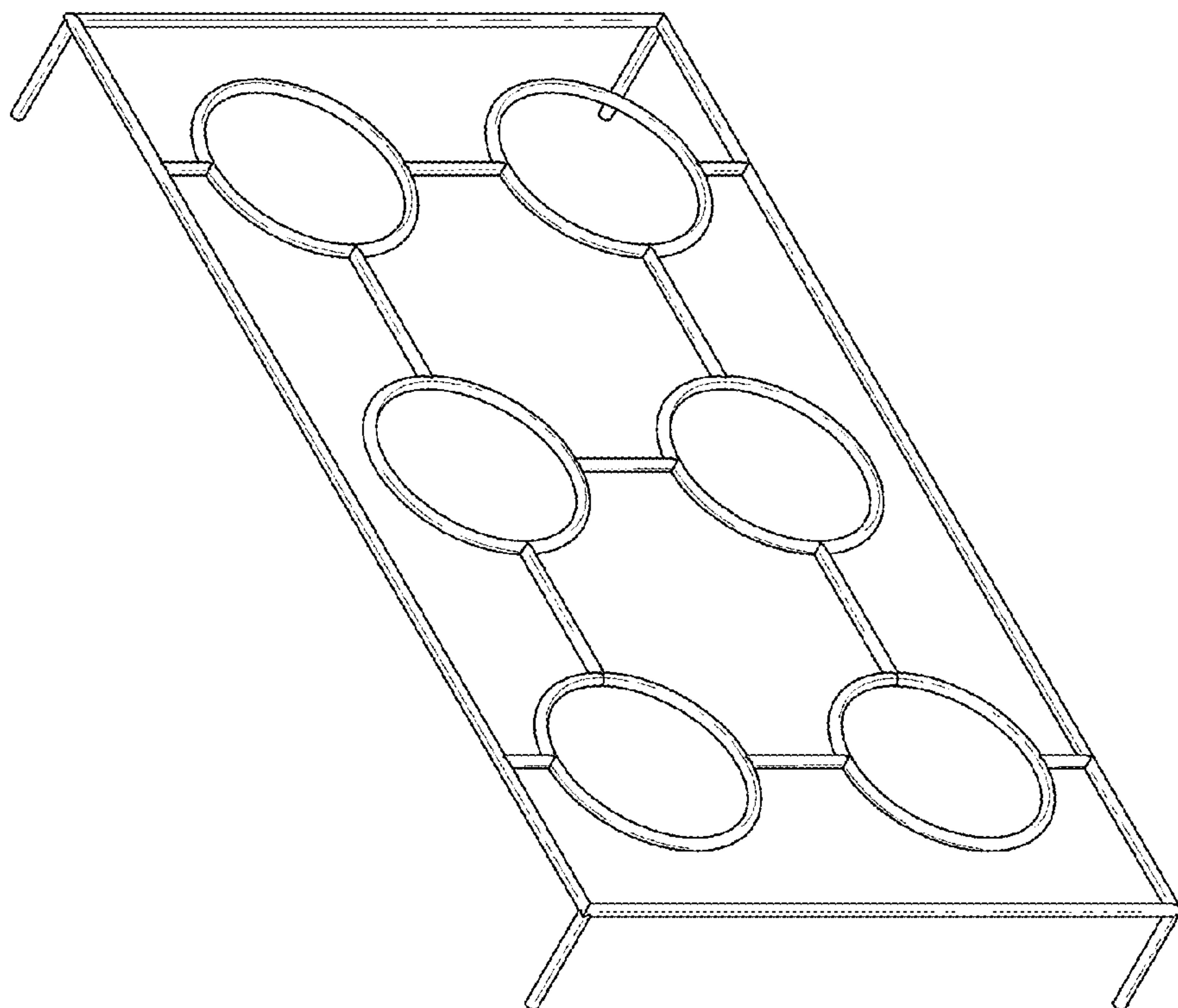

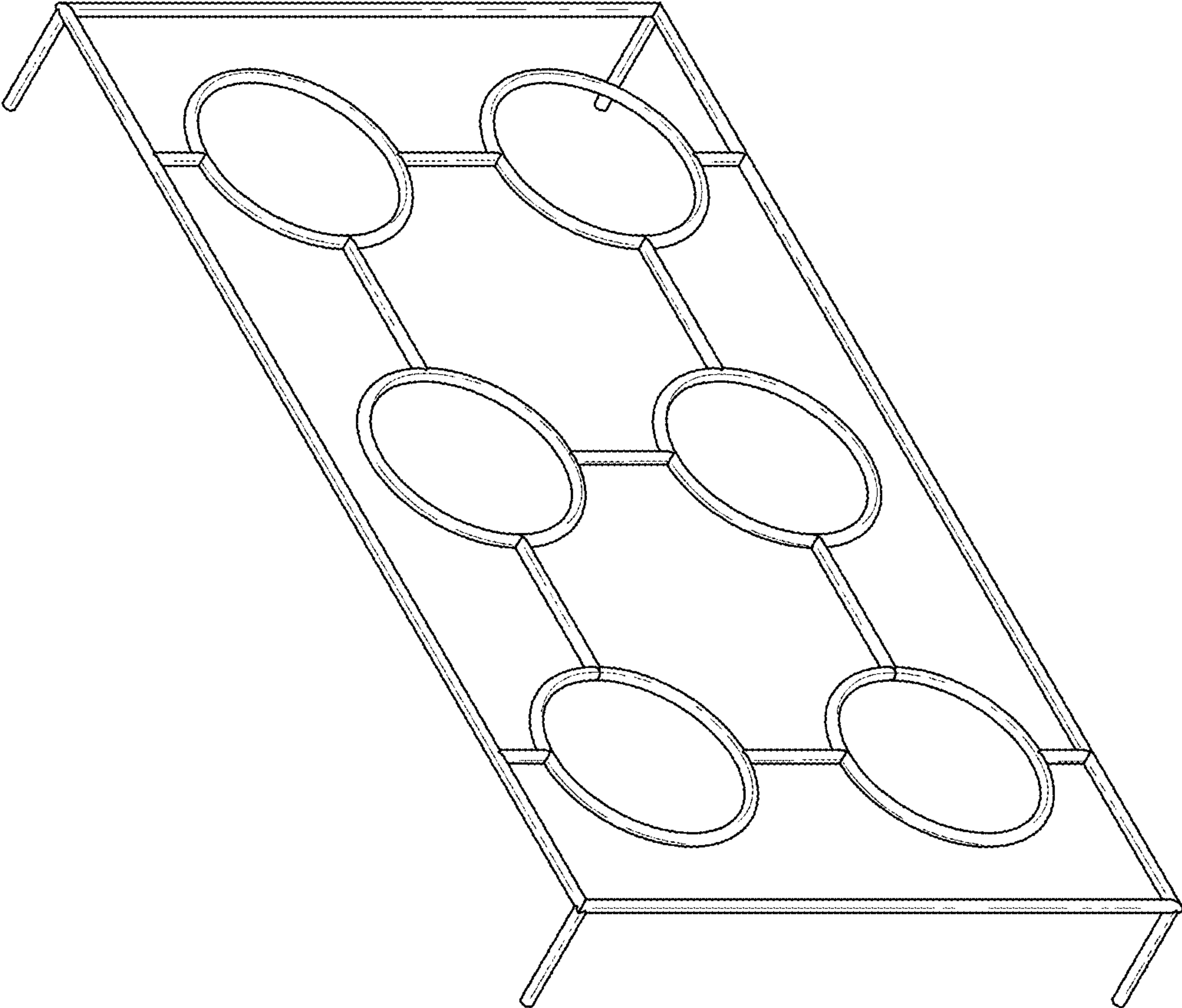

FIG. 1

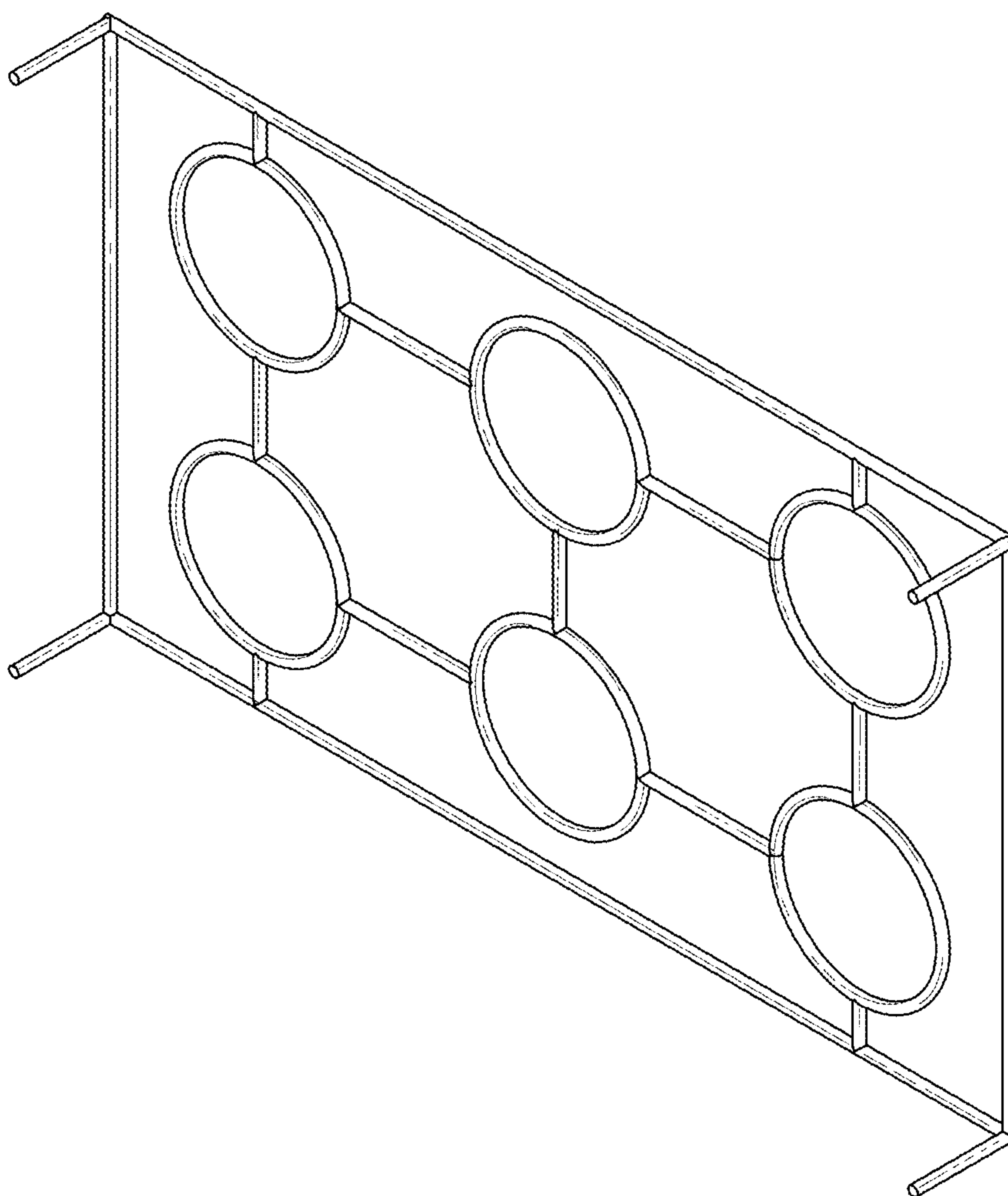

FIG. 2

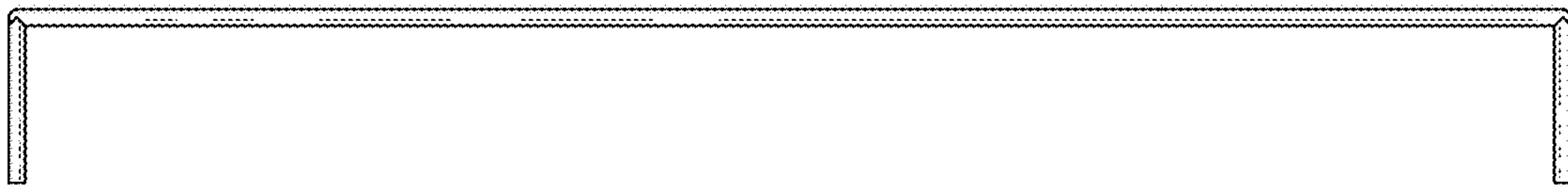

FIG. 3

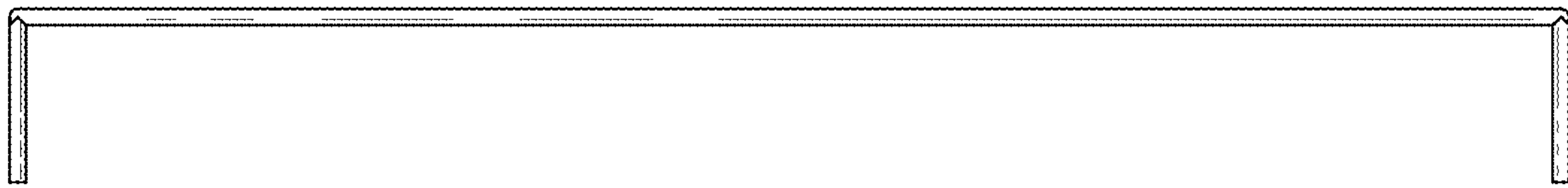

FIG. 4

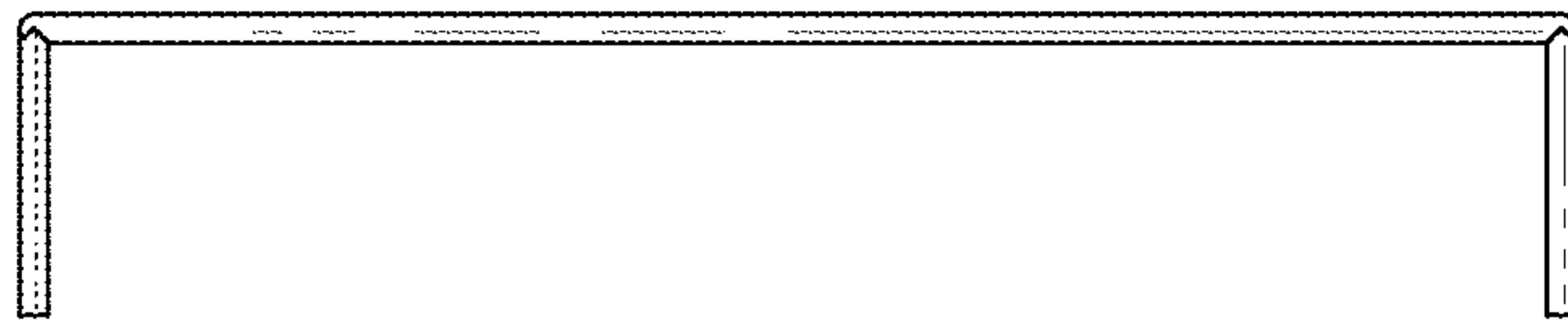

FIG. 5

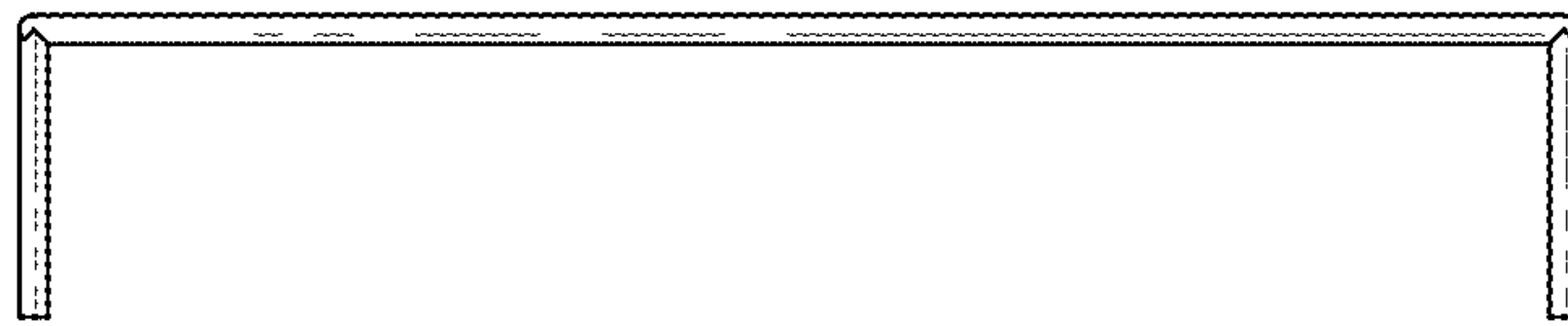

FIG. 6

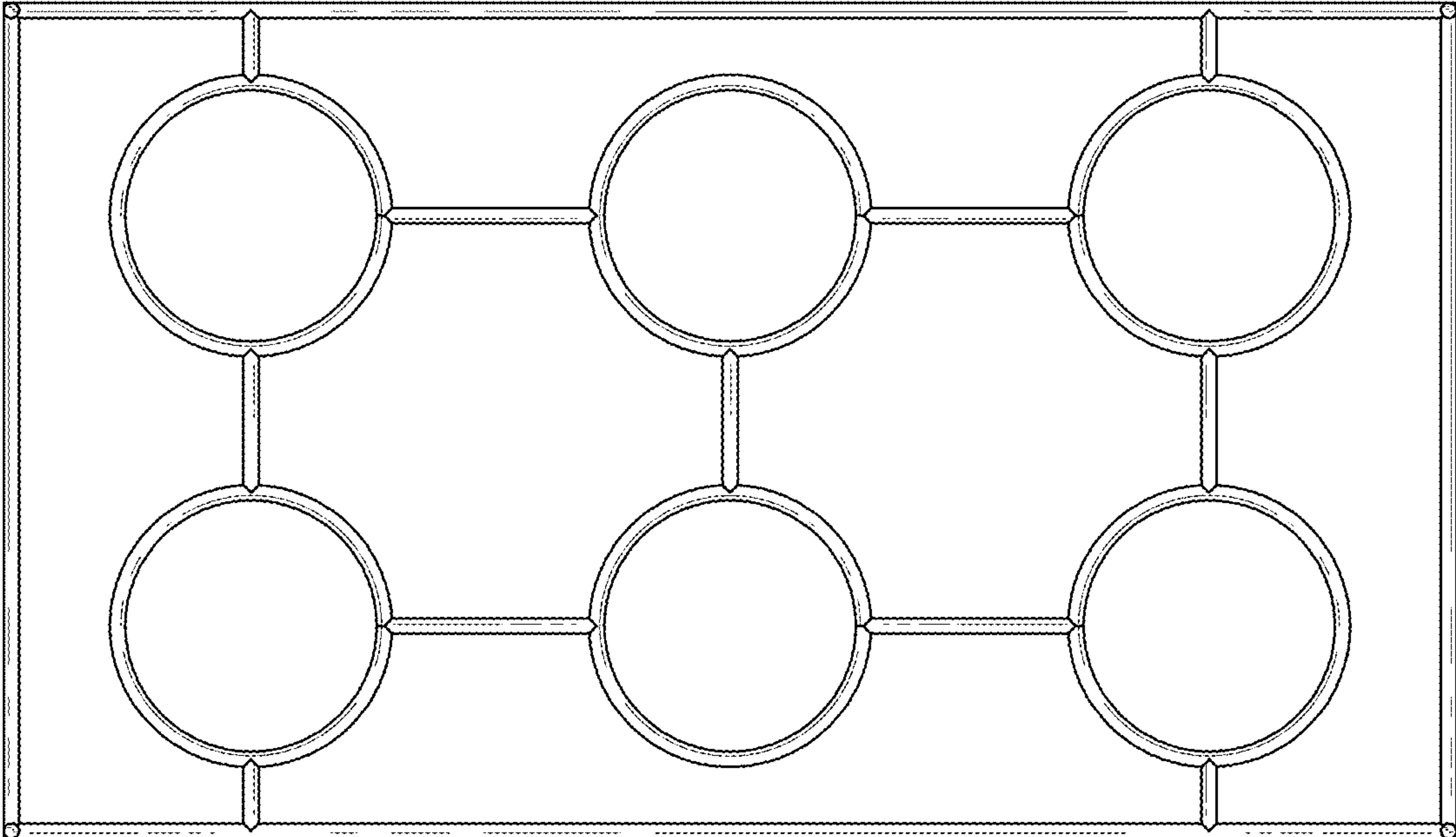

FIG. 7



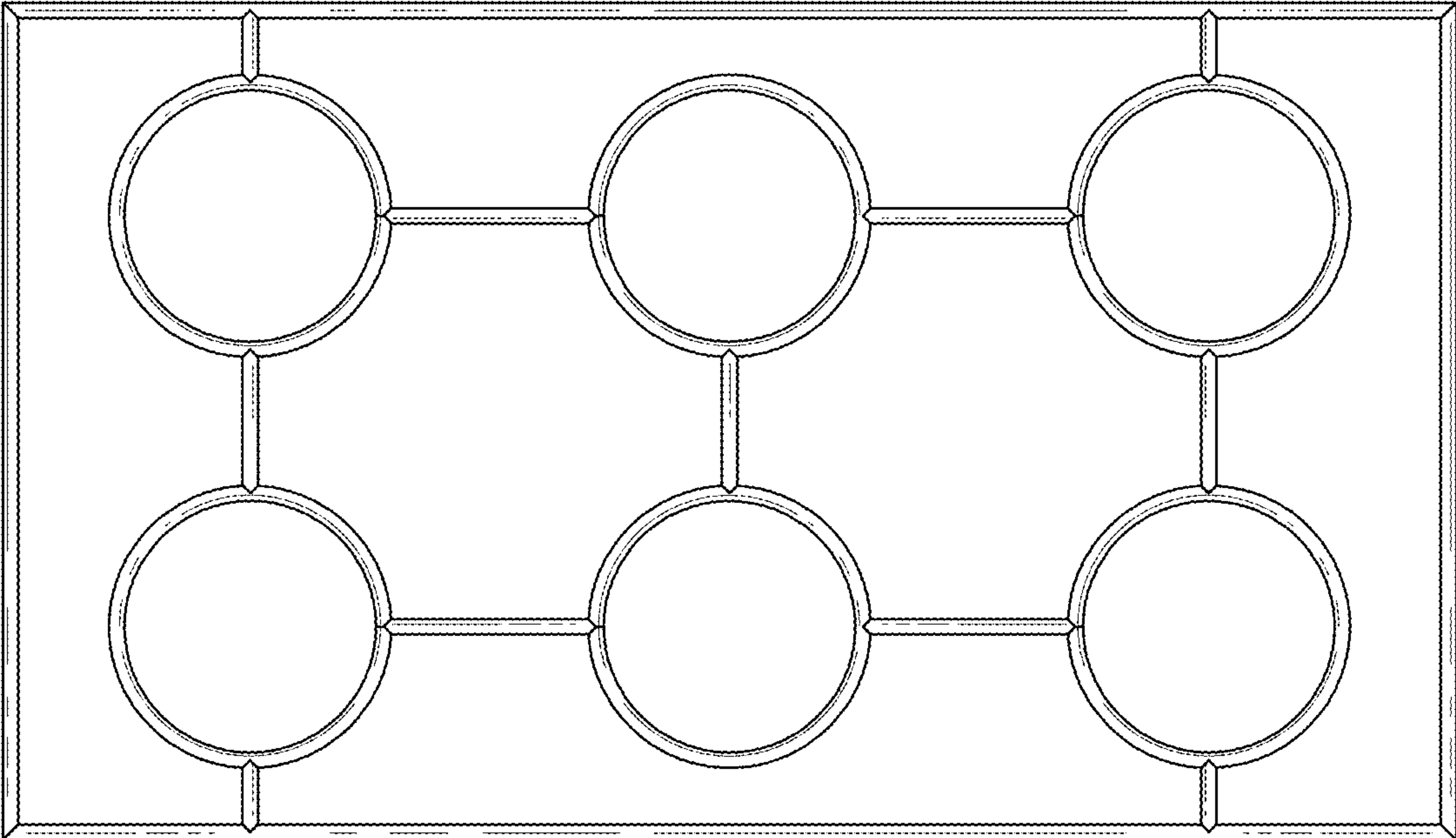

FIG. 8