



US00D781629S

(12) **United States Design Patent**
Handler et al.

(10) **Patent No.:** **US D781,629 S**
(45) **Date of Patent:** **** Mar. 21, 2017**

(54) **TABLE**

- (71) Applicants: **Sheryl Handler**, Cambridge, MA (US); **Carl Martinez**, Easton, PA (US); **Kelly Louise Casilio**, West Newton, MA (US); **Nadine M. Volicer**, Boston, MA (US)
- (72) Inventors: **Sheryl Handler**, Cambridge, MA (US); **Carl Martinez**, Easton, PA (US); **Kelly Louise Casilio**, West Newton, MA (US); **Nadine M. Volicer**, Boston, MA (US)

(73) Assignee: **Art Design Works LLC**, Lexington, MA (US)

(**) Term: **14 Years**

(21) Appl. No.: **29/502,743**

(22) Filed: **Sep. 18, 2014**

(51) **LOC (10) Cl.** **06-03**

(52) **U.S. Cl.**
USPC **D6/707.22**

(58) **Field of Classification Search**
USPC D6/685, 691.3, 696, 697, 702, 707,
D6/707.19, 707.22, 650, 650.1,
D6/696.1-696.7; D25/113, 138, 140
CPC A47B 7/00; A47B 13/08; A47B 13/10;
A47B 21/00

See application file for complete search history.

(56) **References Cited**

U.S. PATENT DOCUMENTS

- D193,790 S * 10/1962 Ohlsson D6/691.9
- 3,267,881 A * 8/1966 Saggione A47B 13/10
108/59
- D207,851 S * 6/1967 Separa D6/406.6
- D244,734 S * 6/1977 Laroye D6/650

(Continued)

OTHER PUBLICATIONS

'Brisk Desk Systems'. dcwebtools.com [online]. 2005 [retrieved Jul. 18, 2016]. Retrieved from the Internet: <URL: http://dcwebtools.com/sw/swchannel/images/ProductCatalog/ProductPage/File/ACF41A.pdf>.*

(Continued)

Primary Examiner — Mary Ann Calabrese
Assistant Examiner — Megan M Majcher Hartnett
(74) *Attorney, Agent, or Firm* — Wolf, Greenfield & Sacks, P.C.

(57) **CLAIM**

The ornamental design for a table, as shown and described.

DESCRIPTION

FIG. 1 is a top, front perspective view of a table showing a first embodiment of our new design;
FIG. 2 is a front elevational view thereof;
FIG. 3 is a rear elevational view thereof;
FIG. 4 is a left side elevational view thereof;
FIG. 5 is a right side elevational view thereof;
FIG. 6 is a top plan view thereof;
FIG. 7 is a bottom plan view thereof;
FIG. 8 is a top, front perspective view showing a second embodiment thereof;
FIG. 9 is a front elevational view of FIG. 8;
FIG. 10 is a rear elevational view of FIG. 8;
FIG. 11 is a right side elevational view of FIG. 8;
FIG. 12 is a left side elevational view of FIG. 8;
FIG. 13 is a top plan view of FIG. 8; and,
FIG. 14 is a bottom plan view of FIG. 8.
The broken lines show portions of the table that form no part of the claimed design.

1 Claim, 12 Drawing Sheets

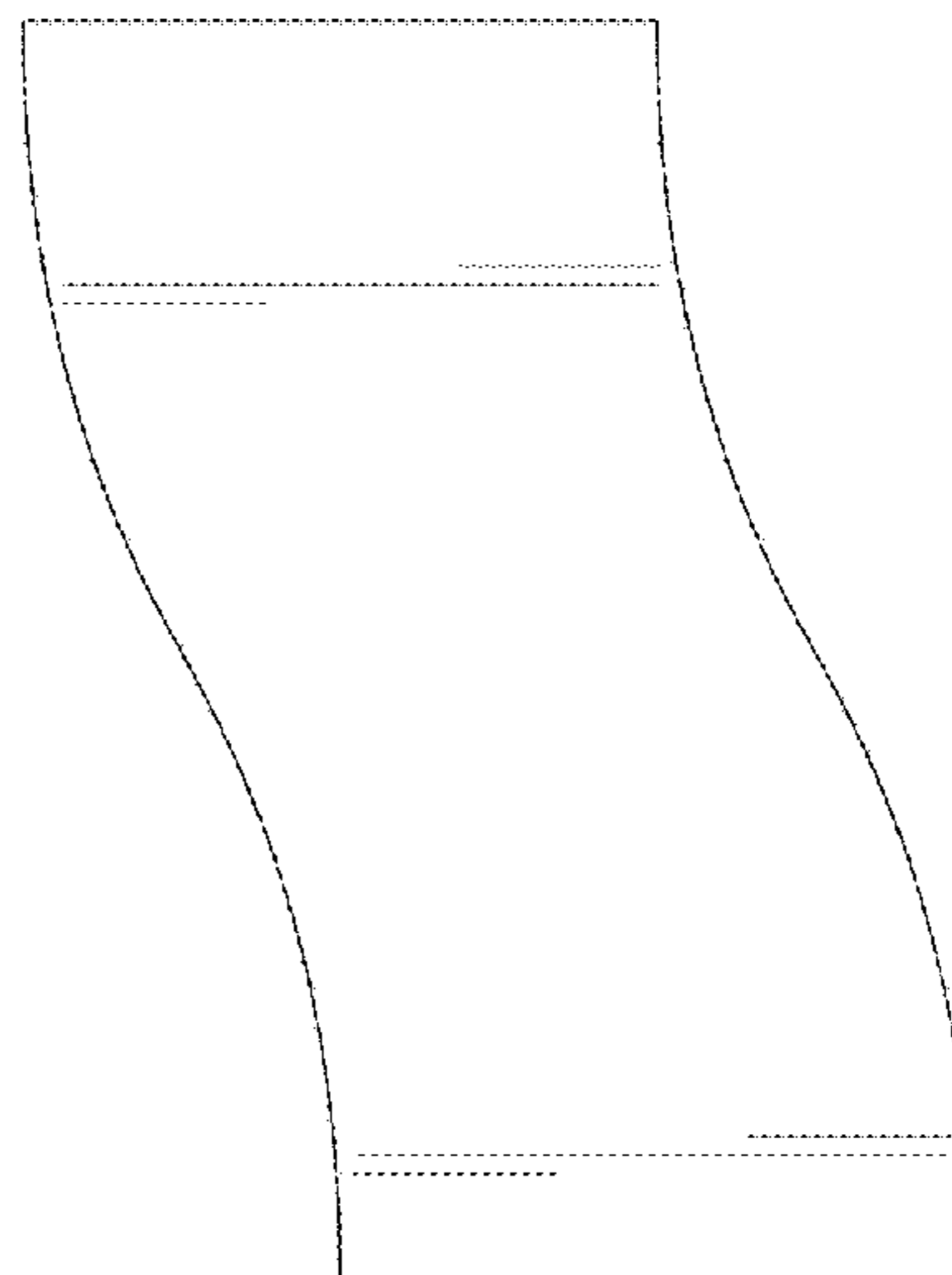
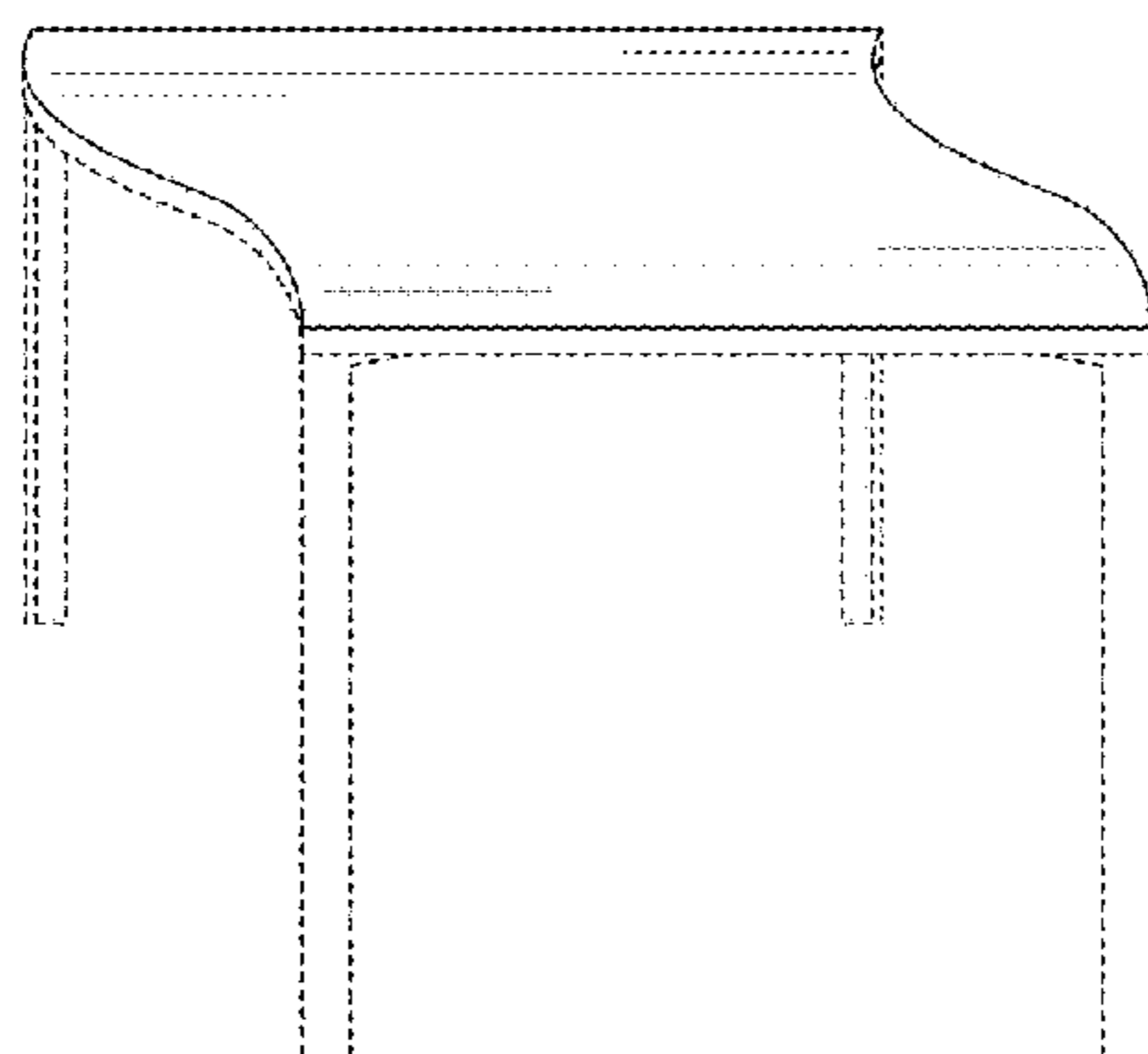

(56)

References Cited

U.S. PATENT DOCUMENTS

D333,228 S * 2/1993 Hosoe D6/696.3
D352,853 S * 11/1994 Hosoe D6/696.3
D383,924 S * 9/1997 Dormon D6/656.13
D388,639 S * 1/1998 Dormon D6/650
D390,381 S * 2/1998 Dormon D6/650
D417,094 S * 11/1999 Schwartz D6/696.2
D449,750 S * 10/2001 Antonioni D6/699
6,363,866 B1 * 4/2002 Schwartz A47B 87/002
108/64
D501,741 S * 2/2005 Risdall D6/644
D524,580 S * 7/2006 Chang D6/650
D527,209 S * 8/2006 Nicoletti D6/650
D559,580 S * 1/2008 Newhouse D6/650
D572,505 S * 7/2008 Davis D6/656.13
D576,823 S * 9/2008 Derocher D6/707.22

D611,727 S * 3/2010 Vail D6/678.1
D670,089 S * 11/2012 Frobose D6/338
D703,984 S * 5/2014 Nasserri D6/707.22

OTHER PUBLICATIONS

‘Correll FS3096S 30" x 96" Granite Gray Plastic Serpentine Fold in Half Table’. webstaurantstore.com [online]. Earliest date Mar. 11, 2013 [retrieved Jul. 18, 2016]. Retrieved from the Internet: <URL: http://www.webstaurantstore.com/...RDb1JTxm8uP_UwSJADu_8pWy3sZrrzwsVDgaa2gyFgRRYGeKwgJ2bXQc7QdlEvujhoCP4rw_wcB>.*
‘Curve TV Stand by Off the Wall’. wayfair.com [online]. Nov. 3, 2015 [retrieved Jul. 18, 2016]. Retrieved from the Internet: <URL: <http://www.wayfair.com/Curve-TV-Stand-CRV-1500-OFTW1006.html?source=hotdeals>>.*

* cited by examiner

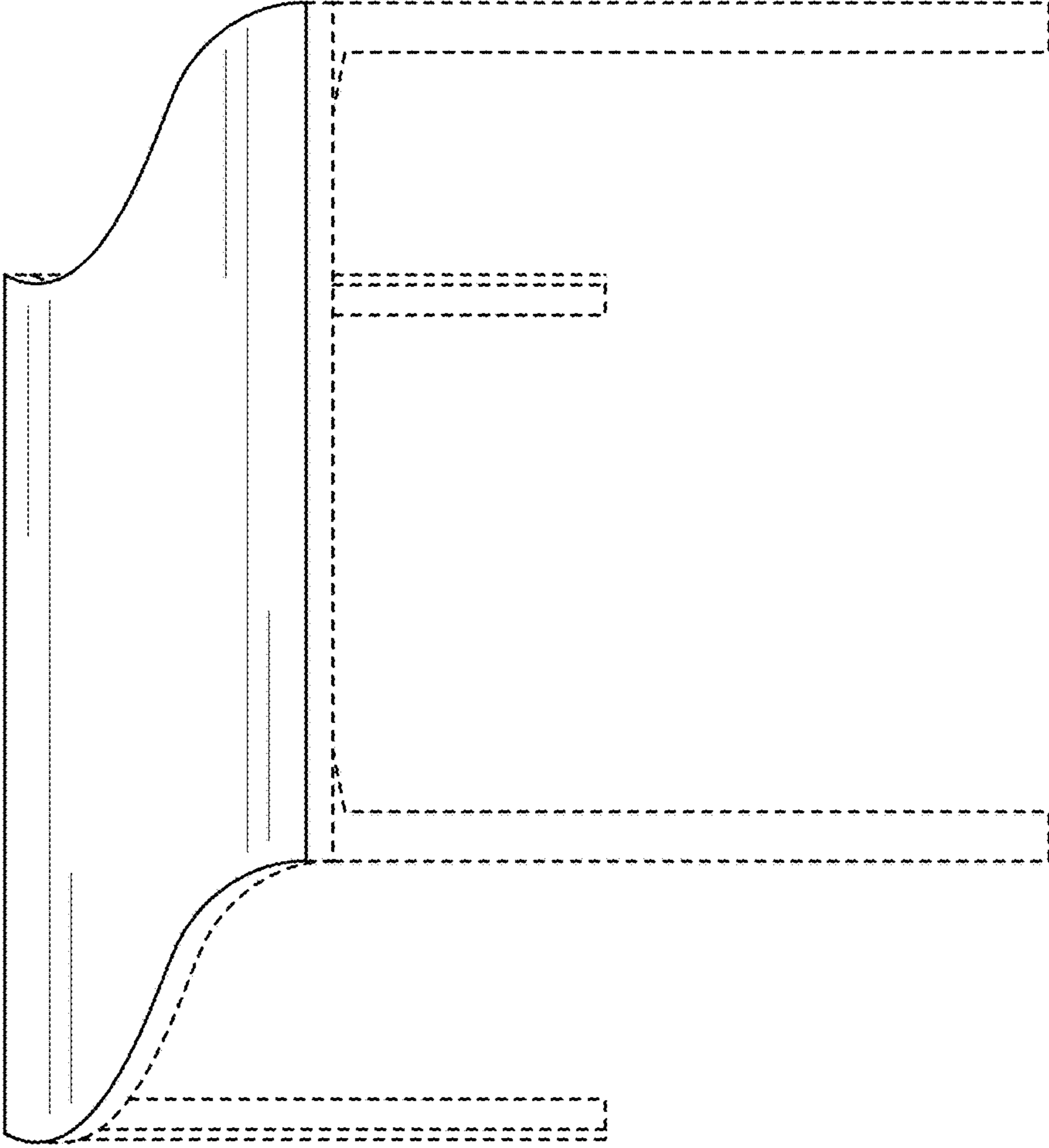

FIG. 1

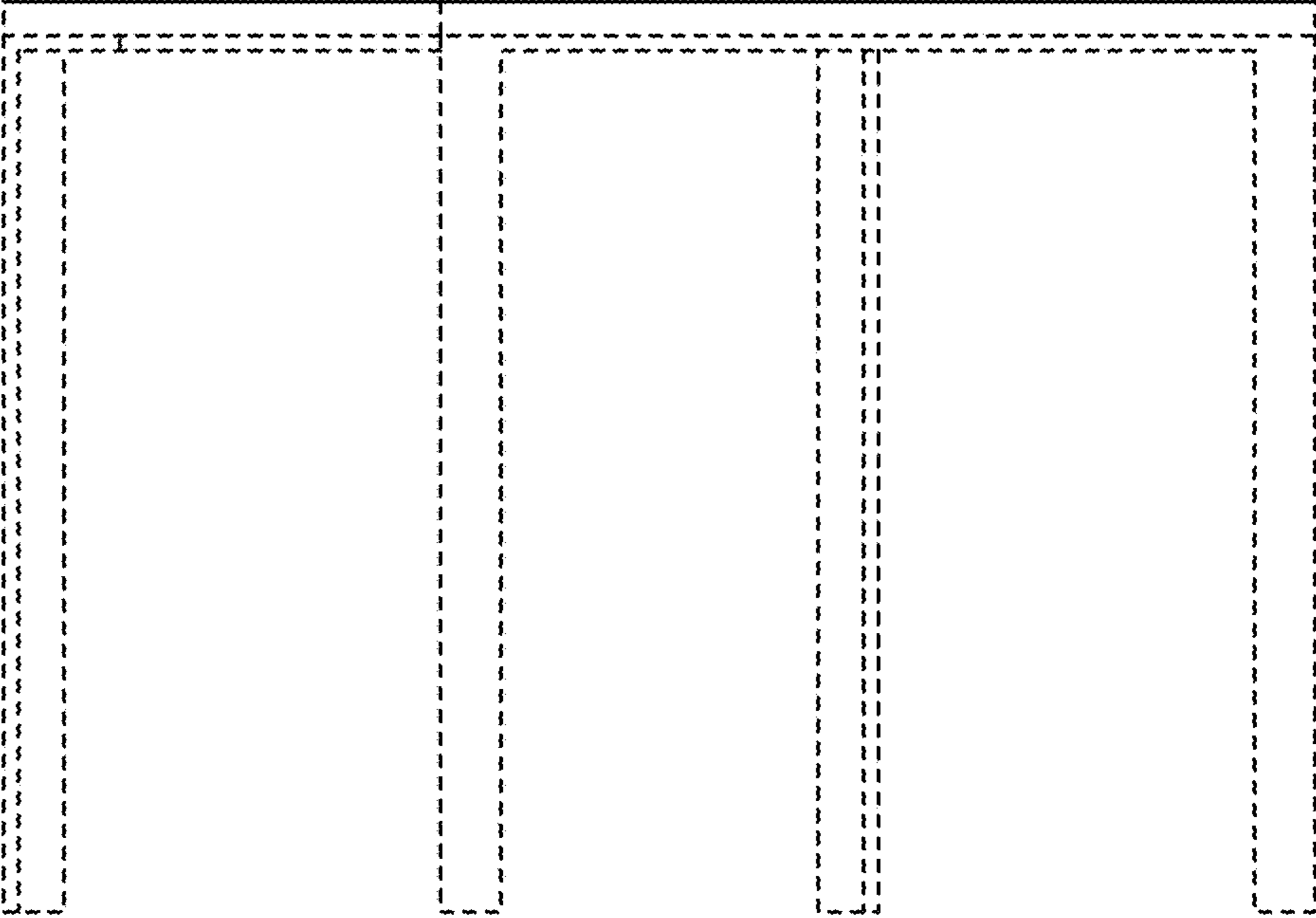

FIG. 2

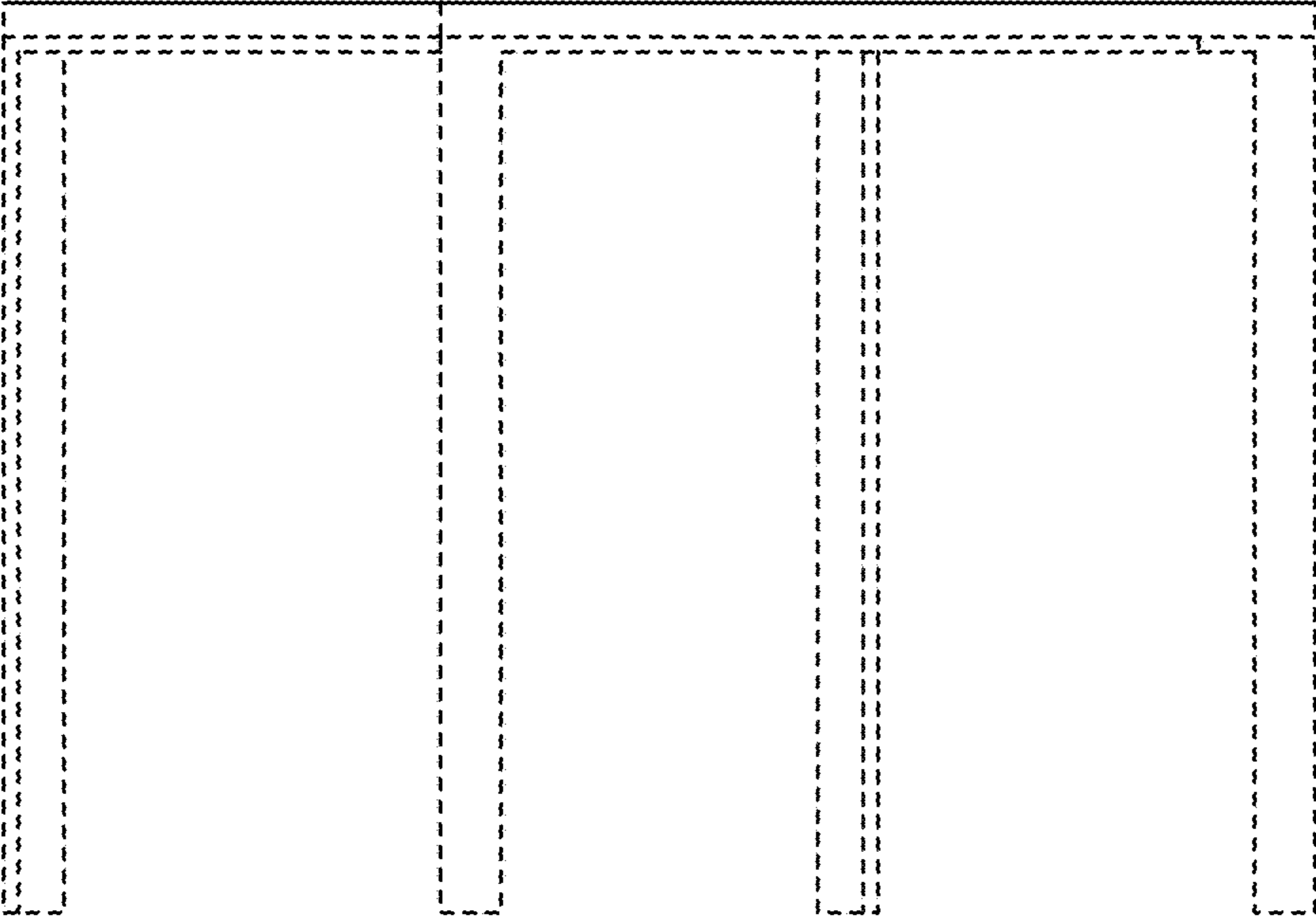

FIG. 3

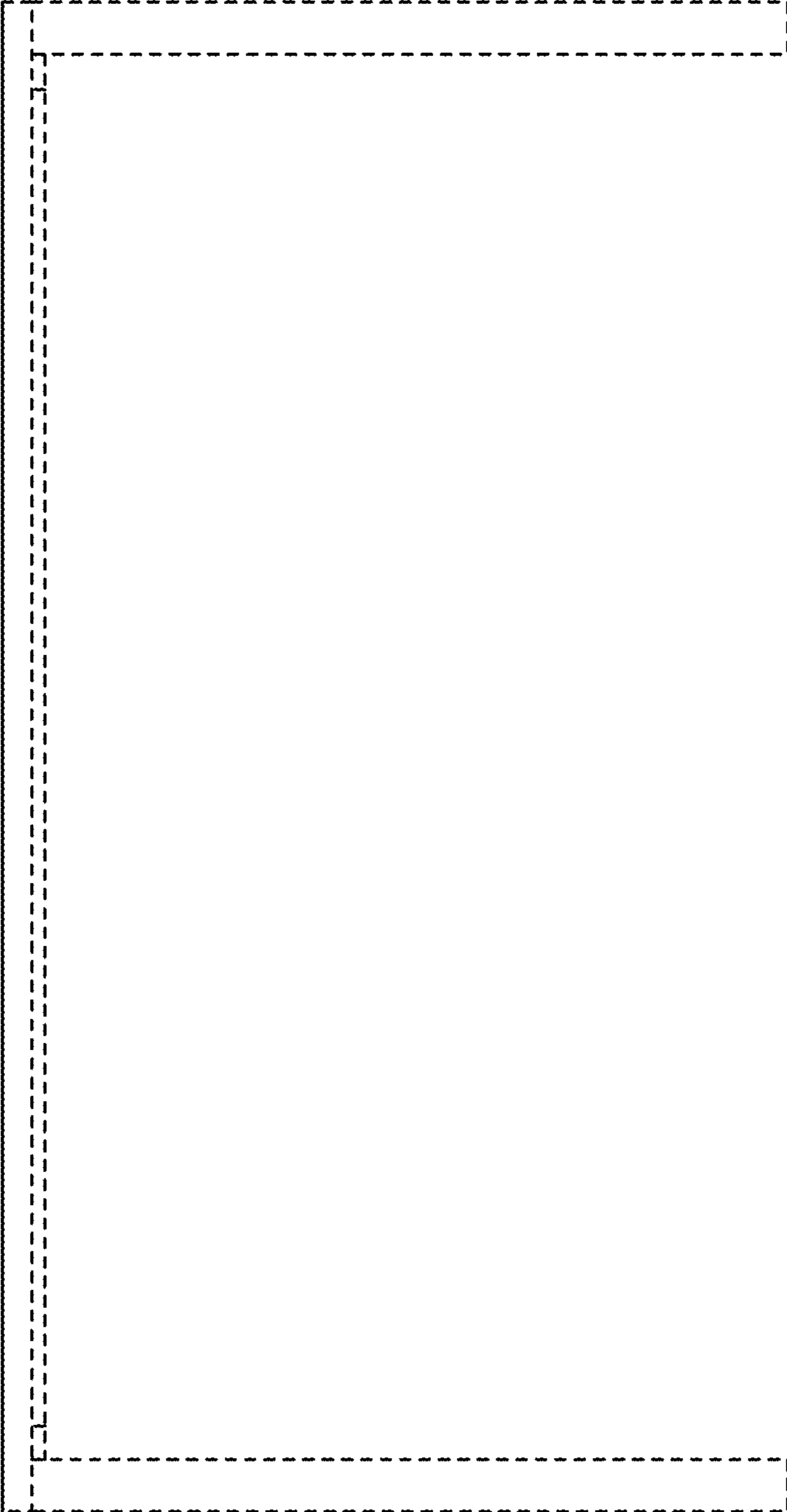

FIG. 4

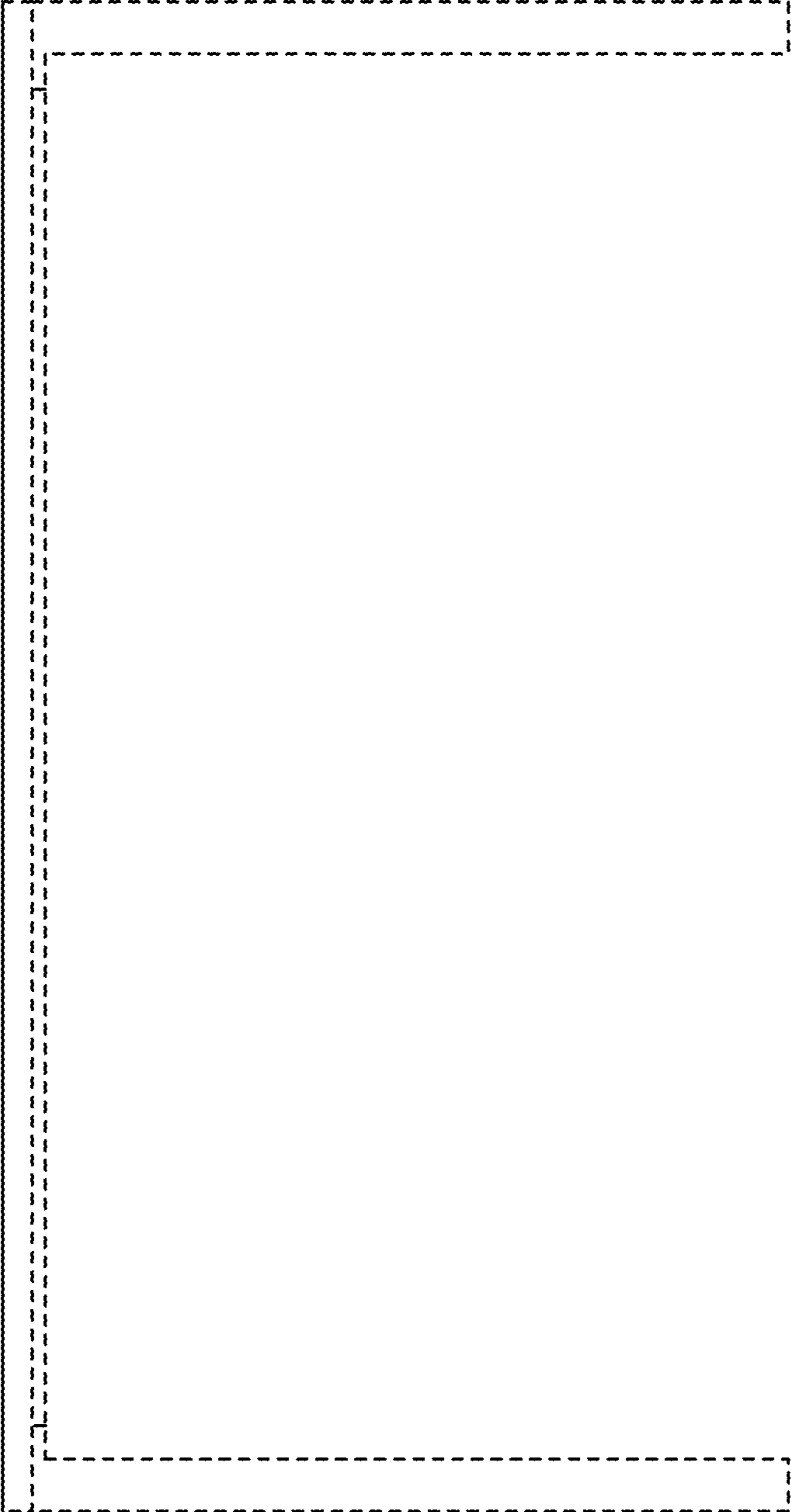

FIG. 5

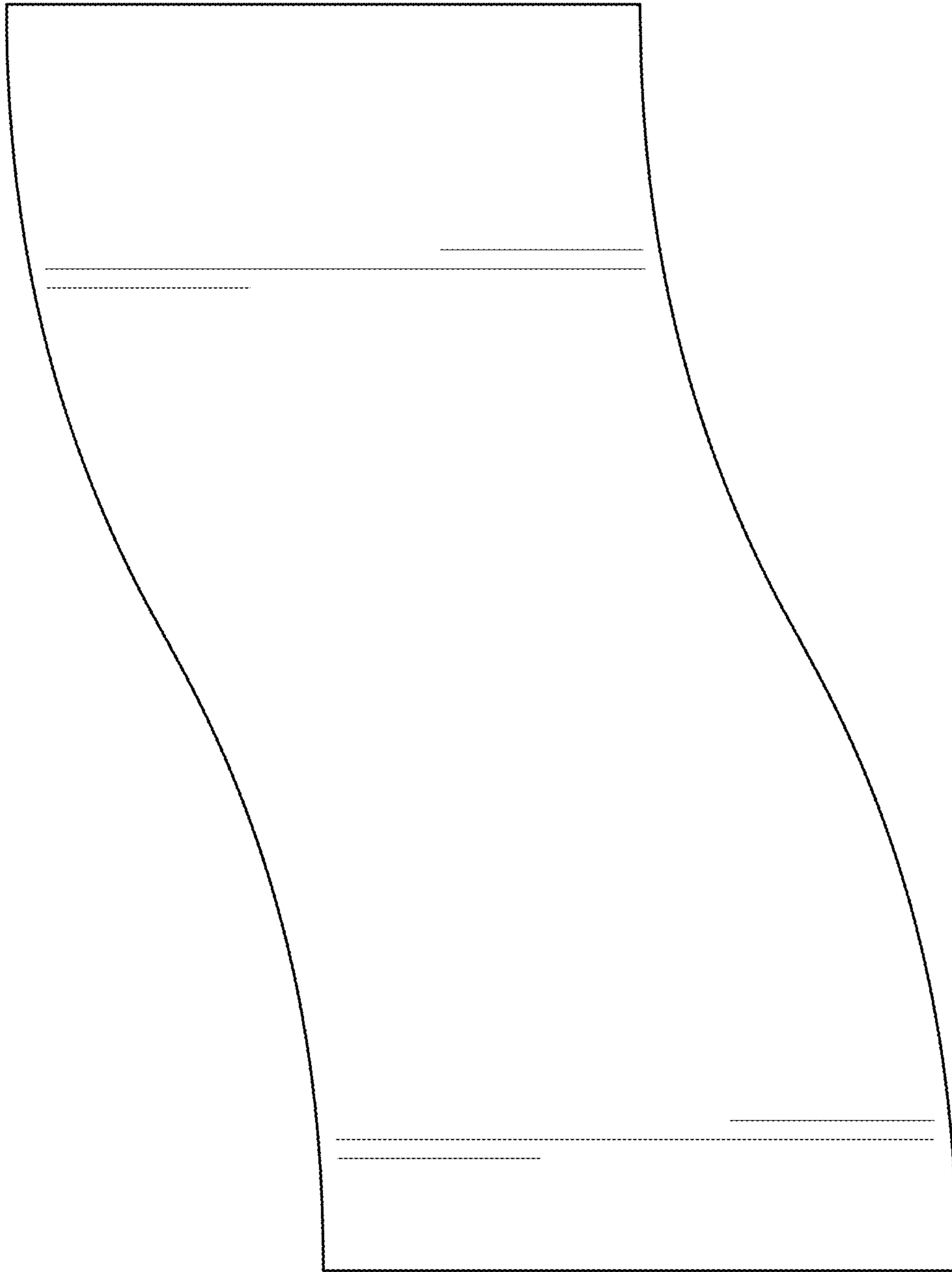

FIG. 6

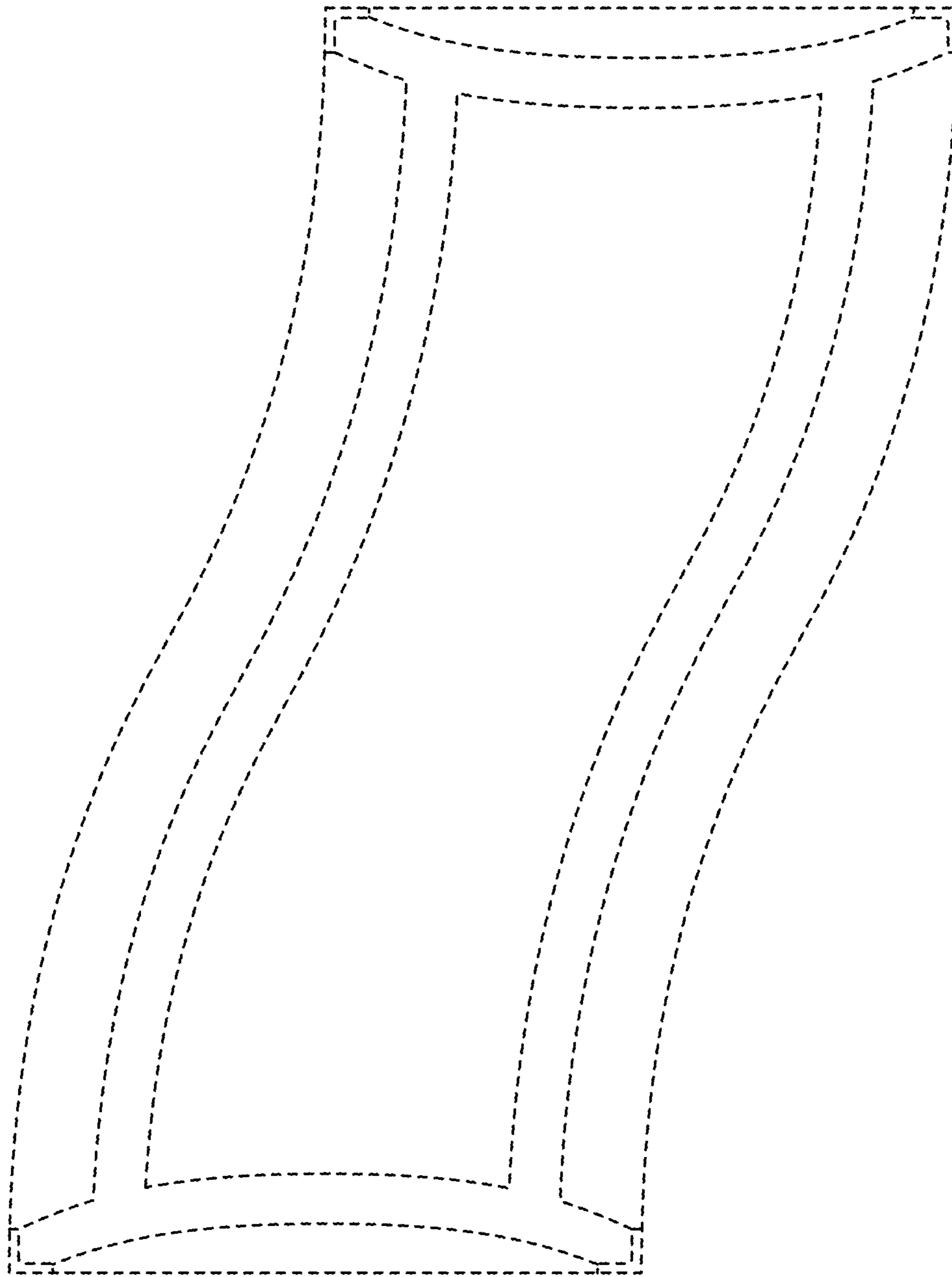

FIG. 7

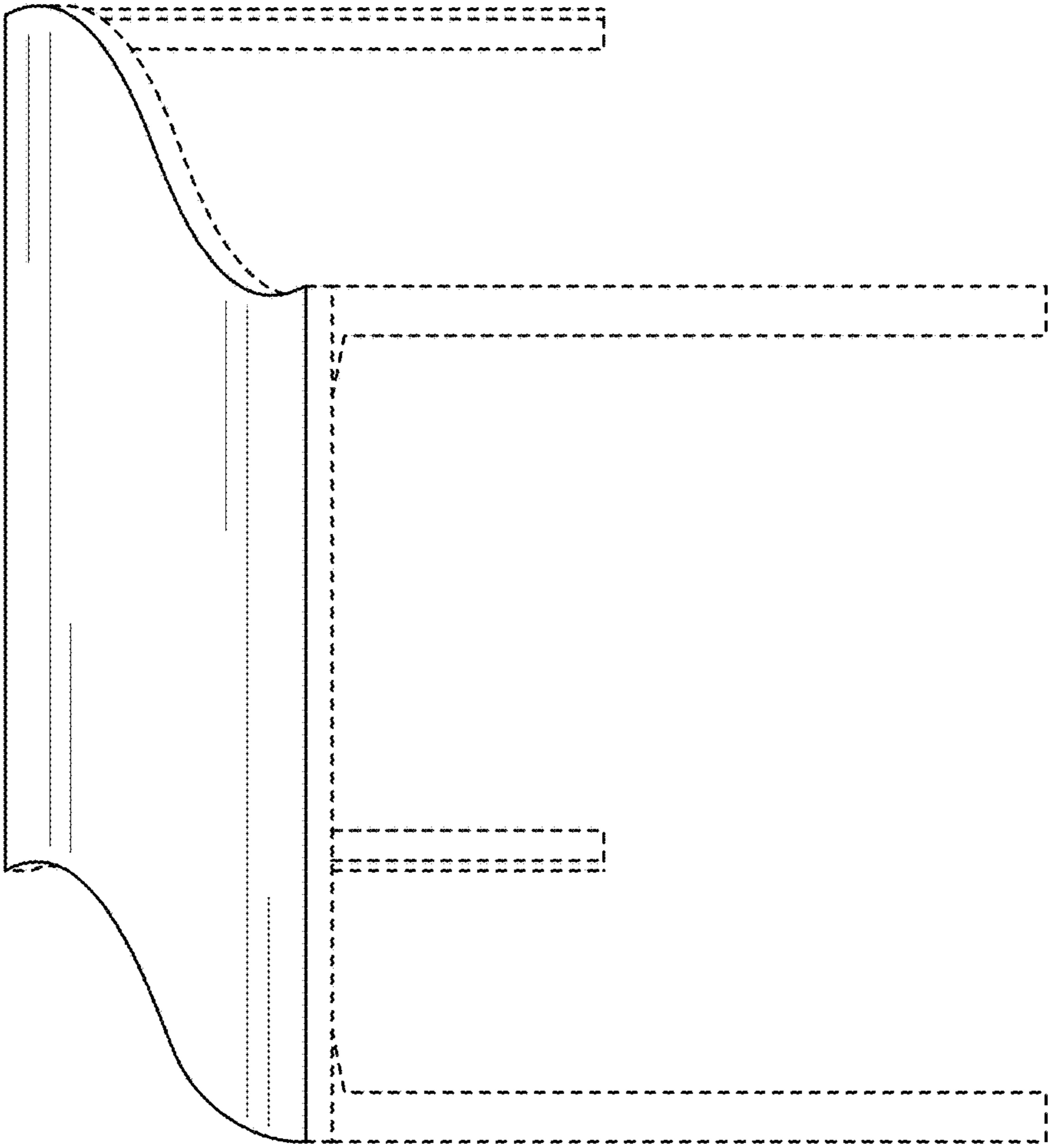

FIG. 8

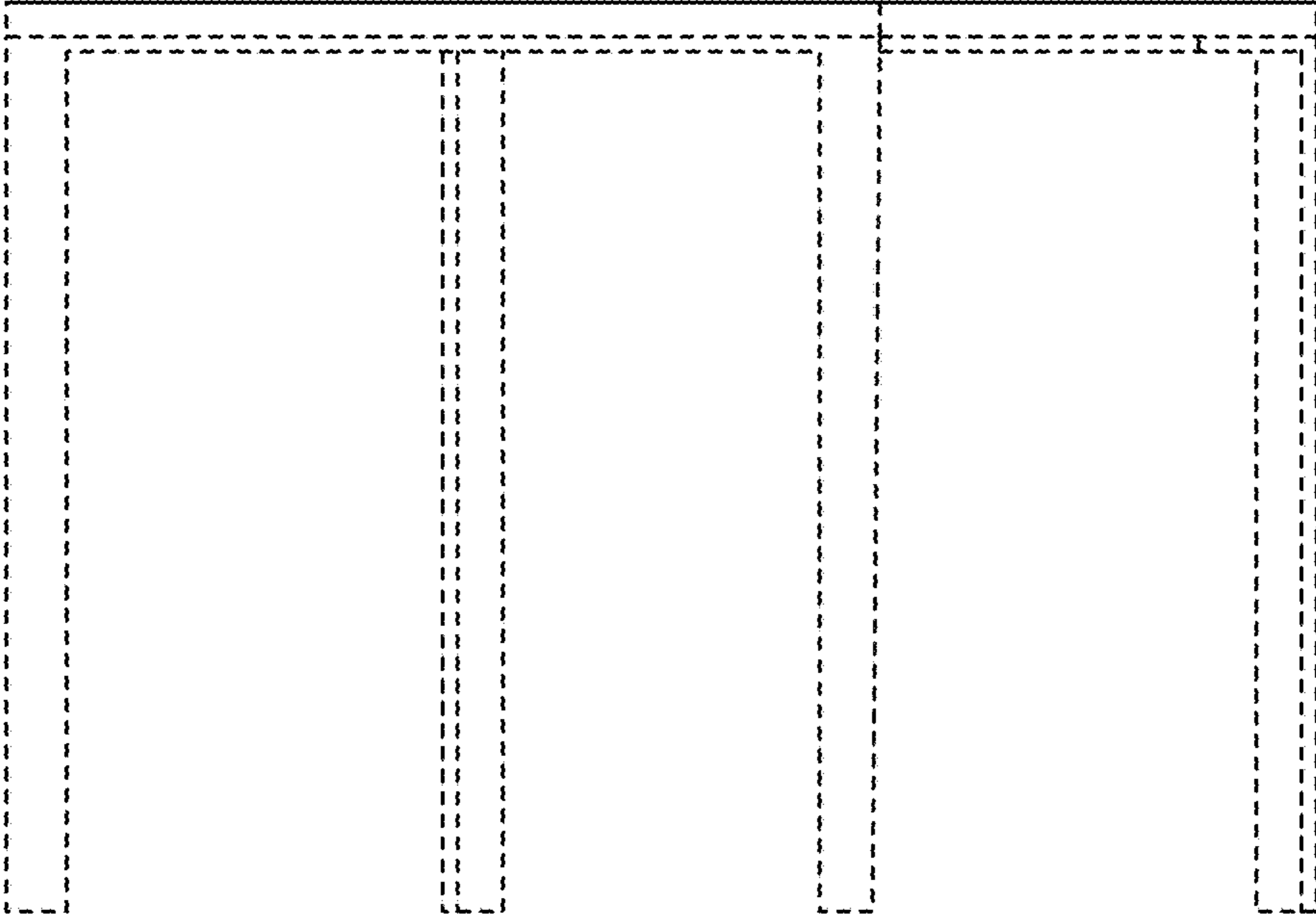

FIG. 9

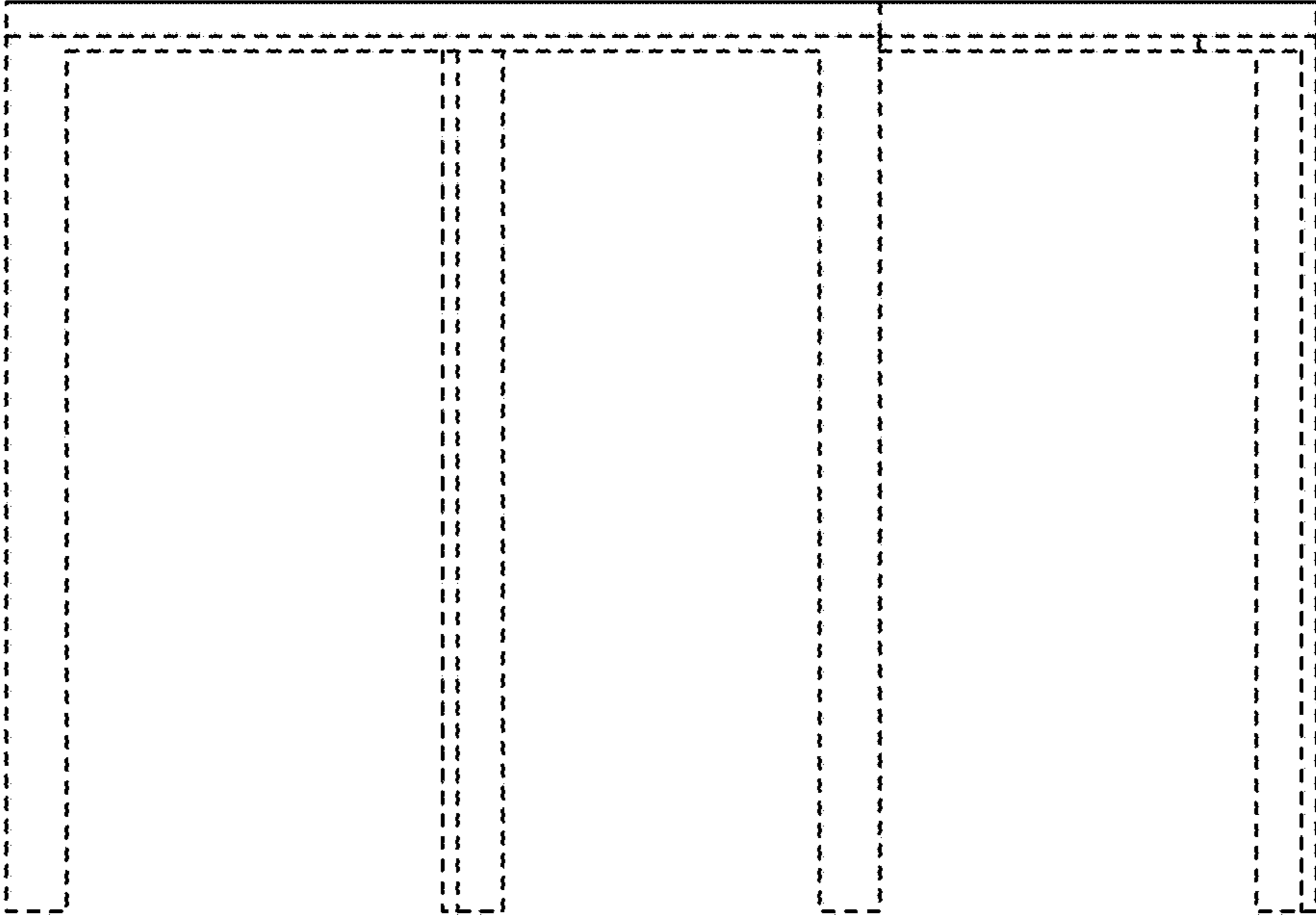

FIG. 10

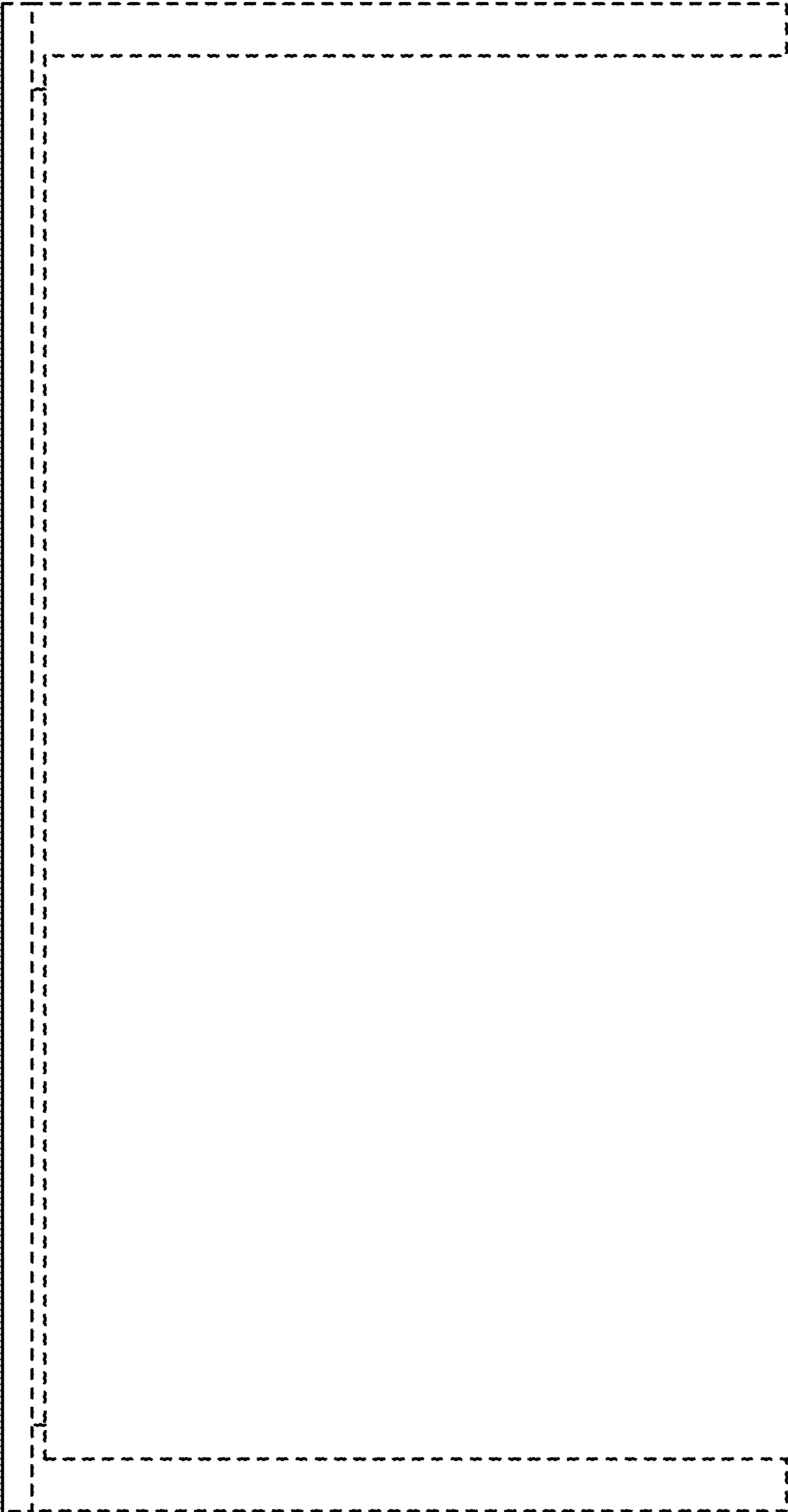

FIG. 11

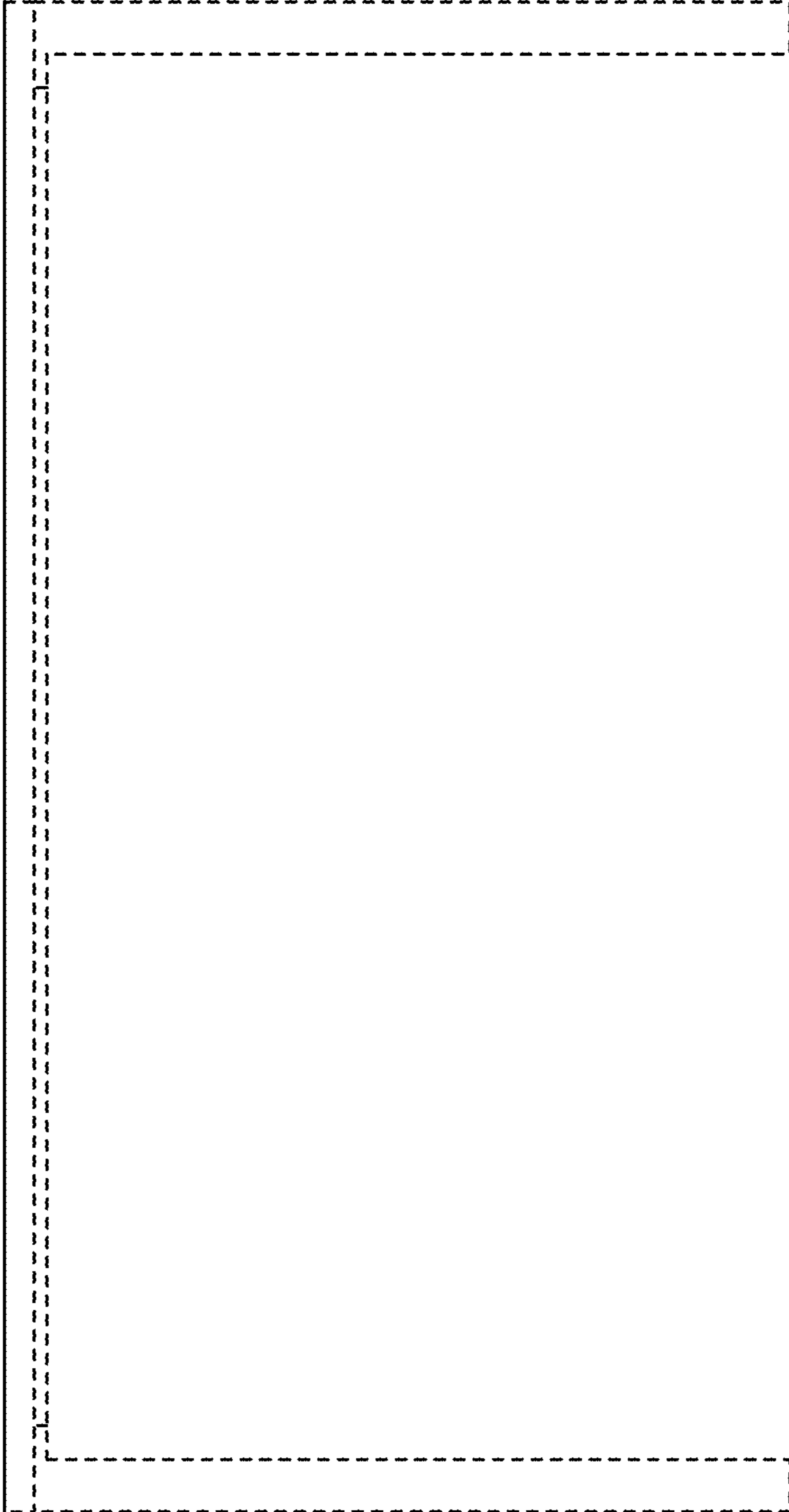

FIG. 12

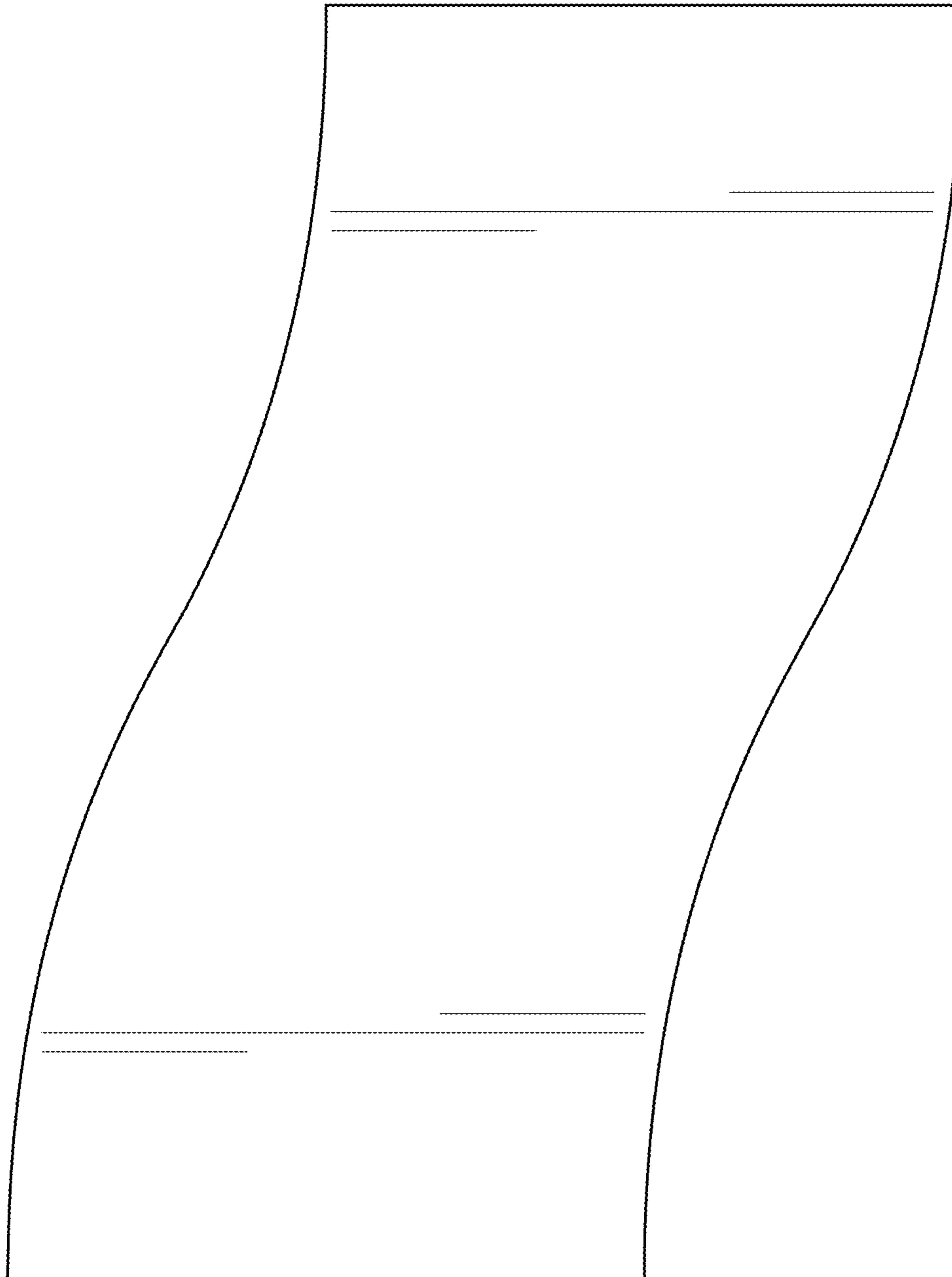

FIG. 13

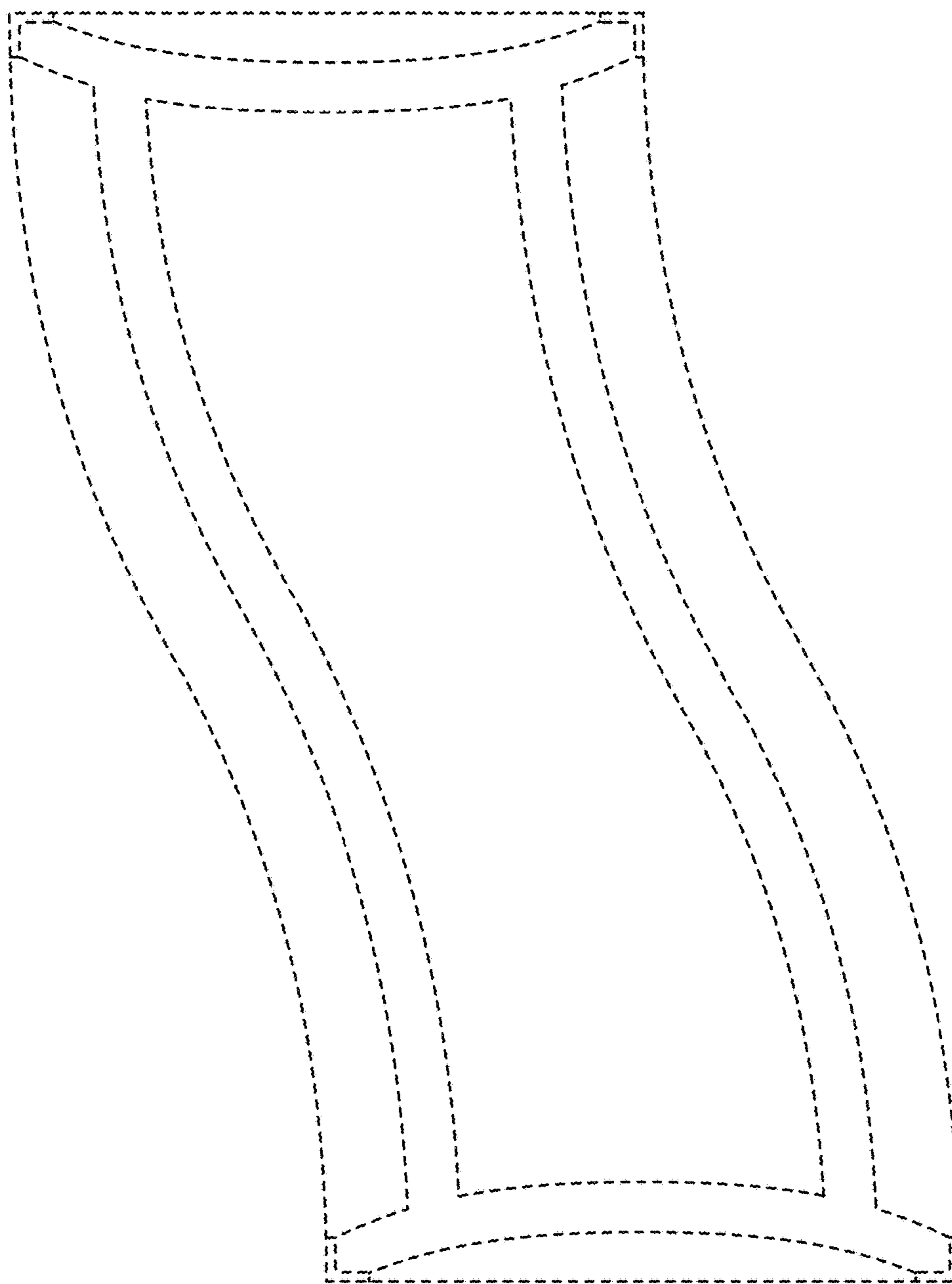

FIG. 14