



US00D781613S

(12) **United States Design Patent**  
**Santoro et al.**

(10) **Patent No.:** **US D781,613 S**  
(45) **Date of Patent:** **\*\* Mar. 21, 2017**

- (54) **DISPENSER HANDLE**
- (71) Applicant: **Vi-Jon, Inc.**, St. Louis, MO (US)
- (72) Inventors: **Donna M. Santoro**, St. Charles, MO (US); **Andy Lee Kirkpatrick**, Green Bay, WI (US); **Kacey James Kreuter**, Green Bay, WI (US)
- (73) Assignee: **Vi-Jon, Inc.**, St. Louis, MO (US)
- (\*\*) Term: **14 Years**
- (21) Appl. No.: **29/523,436**
- (22) Filed: **Apr. 9, 2015**
- (51) **LOC (10) Cl.** ..... **23-02**
- (52) **U.S. Cl.**  
USPC ..... **D6/545**
- (58) **Field of Classification Search**  
USPC ..... D6/542-545; D9/682, 688, 690, 291, D9/448, 449; 221/282, 14, 173, 146.3, 221/628, 251, 181.1, 181.3  
CPC ..... B67D 1/001; B67D 1/06; A47K 7/04  
See application file for complete search history.

D728,966 S *	5/2015	Lewis	.....	D6/545
D732,308 S *	6/2015	Enga	.....	D6/542
2005/0087552 A1 *	4/2005	Ciavarella	.....	A47K 5/12 222/181.1
2010/0224651 A1 *	9/2010	Zlatic	.....	A47K 5/122 222/182
2012/0080452 A1 *	4/2012	Boshuizen	.....	G01F 11/00 222/181.3
2012/0228326 A1 *	9/2012	Ciavarella	.....	G09F 7/18 222/108
2013/0292410 A1 *	11/2013	Pelkey	.....	A47K 5/1202 222/52

\* cited by examiner

*Primary Examiner* — David Muller  
*Assistant Examiner* — Nathan Johnston  
(74) *Attorney, Agent, or Firm* — Armstrong Teasdale LLP

(57) **CLAIM**

We claim the ornamental design for a dispenser handle, as shown and described.

**DESCRIPTION**

FIG. 1 is a front perspective view of a dispenser handle showing our new design;  
FIG. 2 is a front elevation view thereof;  
FIG. 3 is a rear elevation view thereof;  
FIG. 4 is a right elevation view thereof;  
FIG. 5 is a left elevation view thereof;  
FIG. 6 is a top plan view thereof;  
FIG. 7 is a bottom plan view thereof; and,  
FIG. 8 is a rear perspective view thereof.  
The broken line showing of dispenser handle is included for the purpose of illustrating portions of the “article” and forms no part of the claimed design.

**1 Claim, 8 Drawing Sheets**

(56) **References Cited**

U.S. PATENT DOCUMENTS

5,464,125 A *	11/1995	Daansen	.....	A47K 5/1215 222/156
D431,404 S *	10/2000	Brazis	.....	D6/545
D616,684 S *	6/2010	Ciavarella	.....	D6/545
D631,681 S *	2/2011	Ciavarella	.....	D6/545
D653,482 S *	2/2012	Ciavarella	.....	D6/545
D675,853 S *	2/2013	Bunoz	.....	D6/545

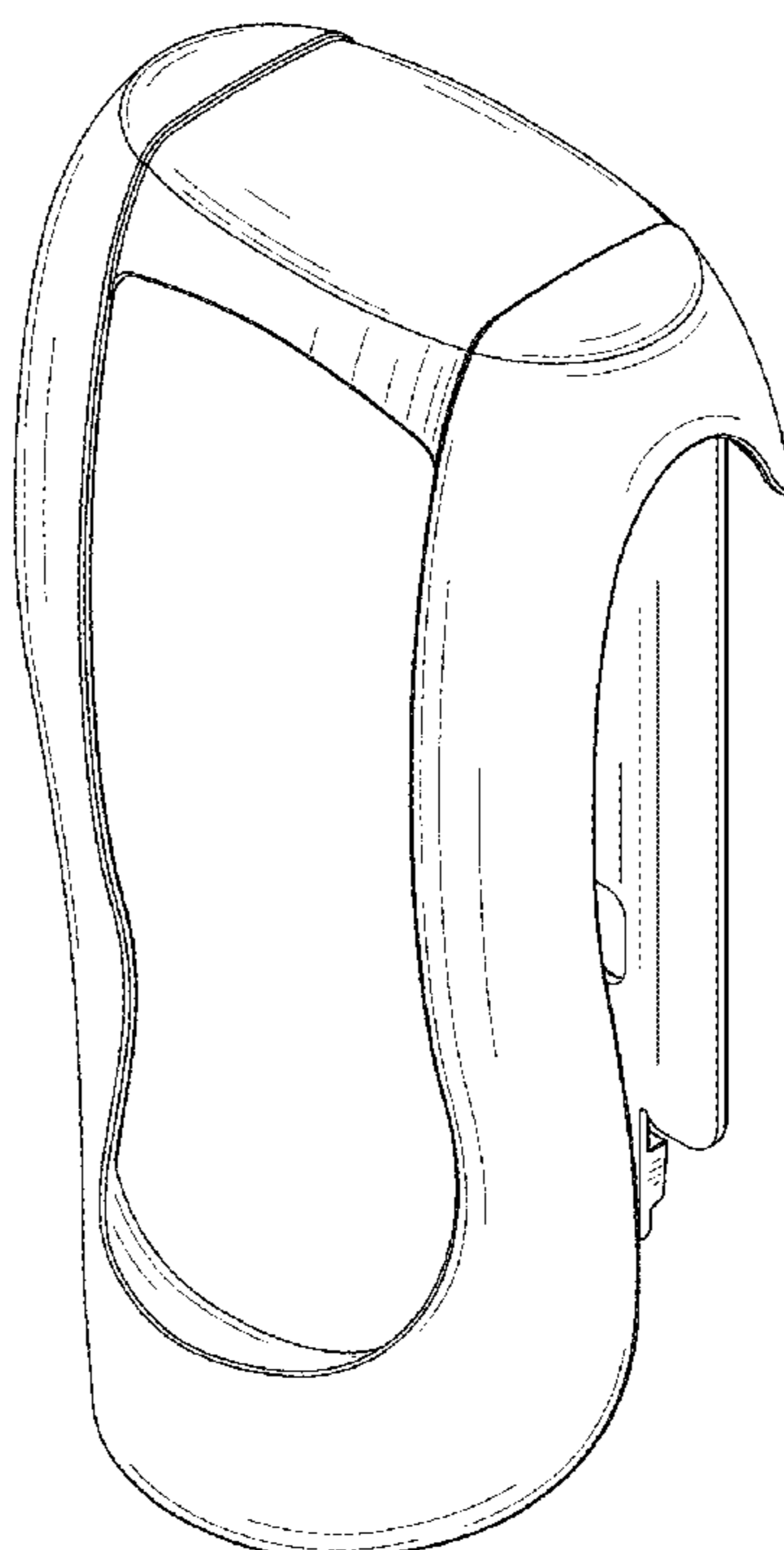

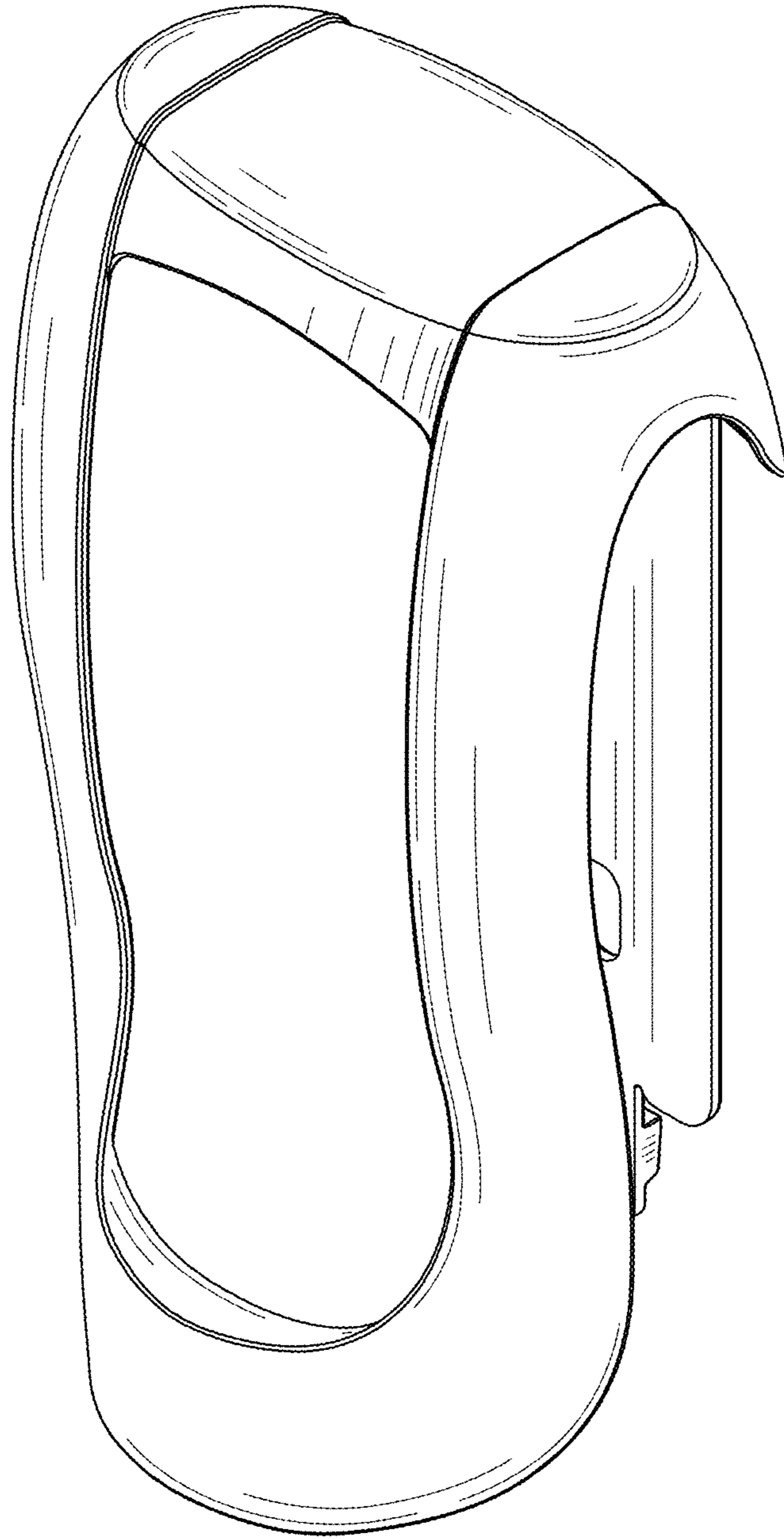

FIG. 1

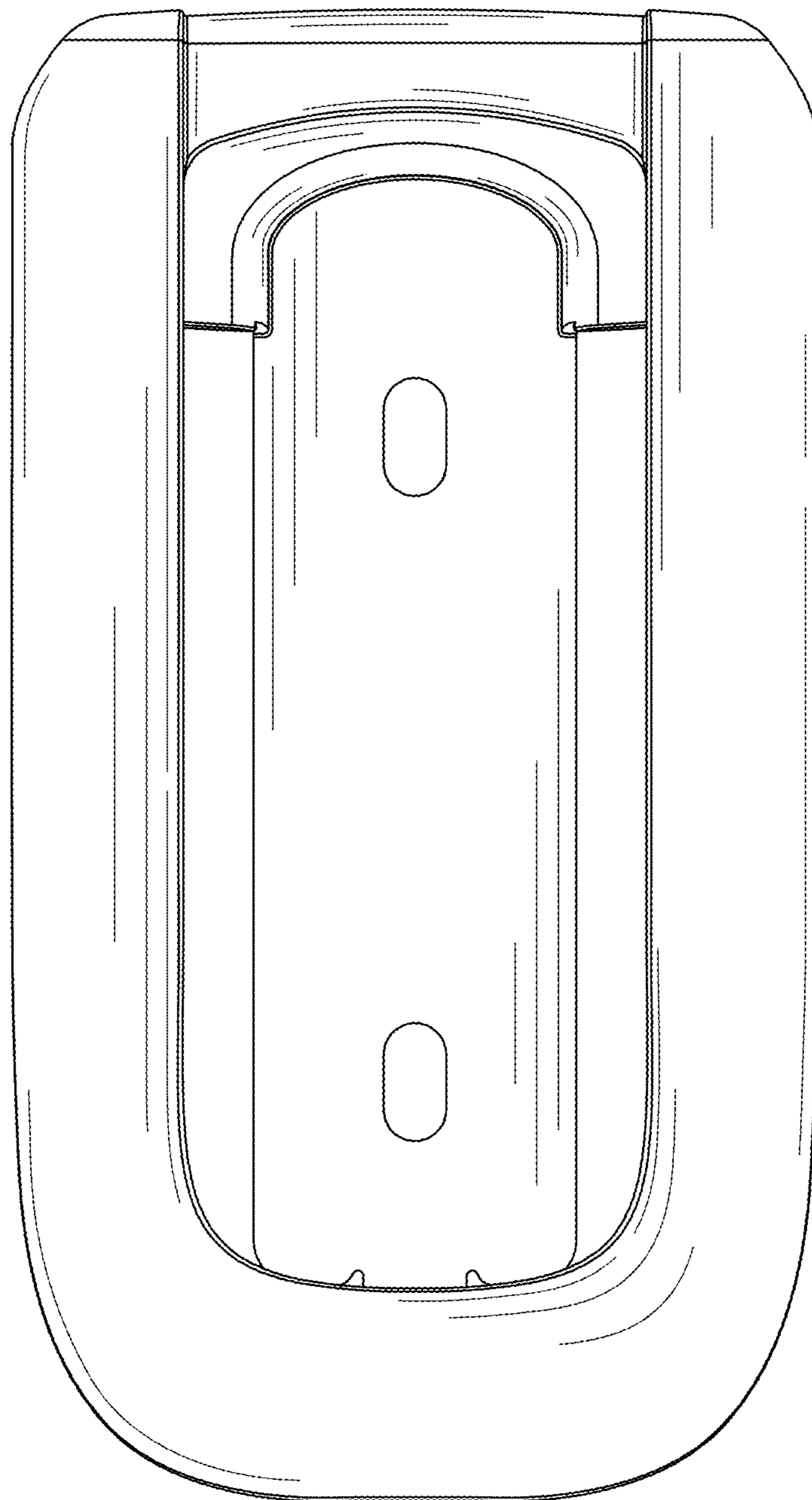

FIG. 2

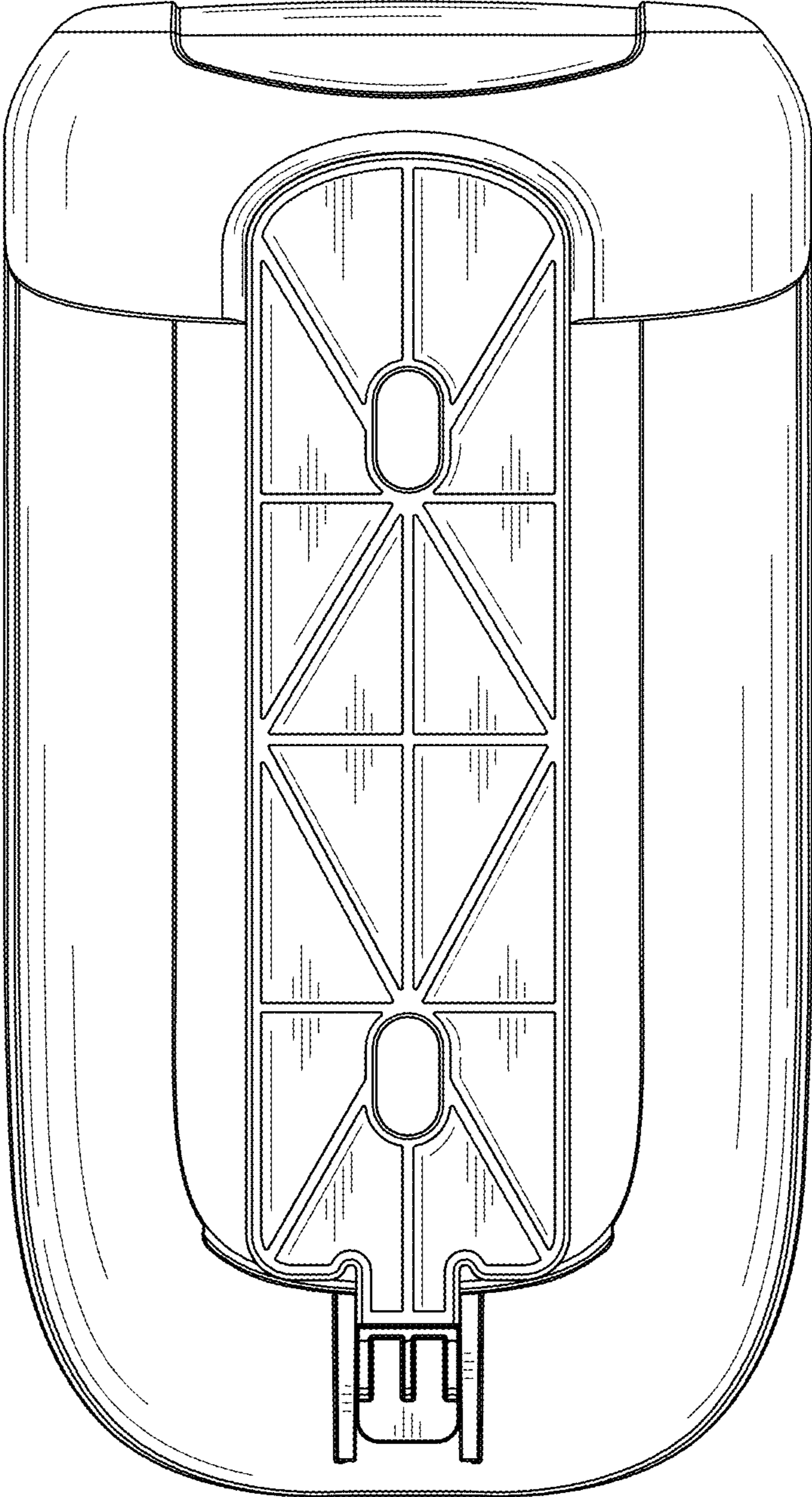

FIG. 3

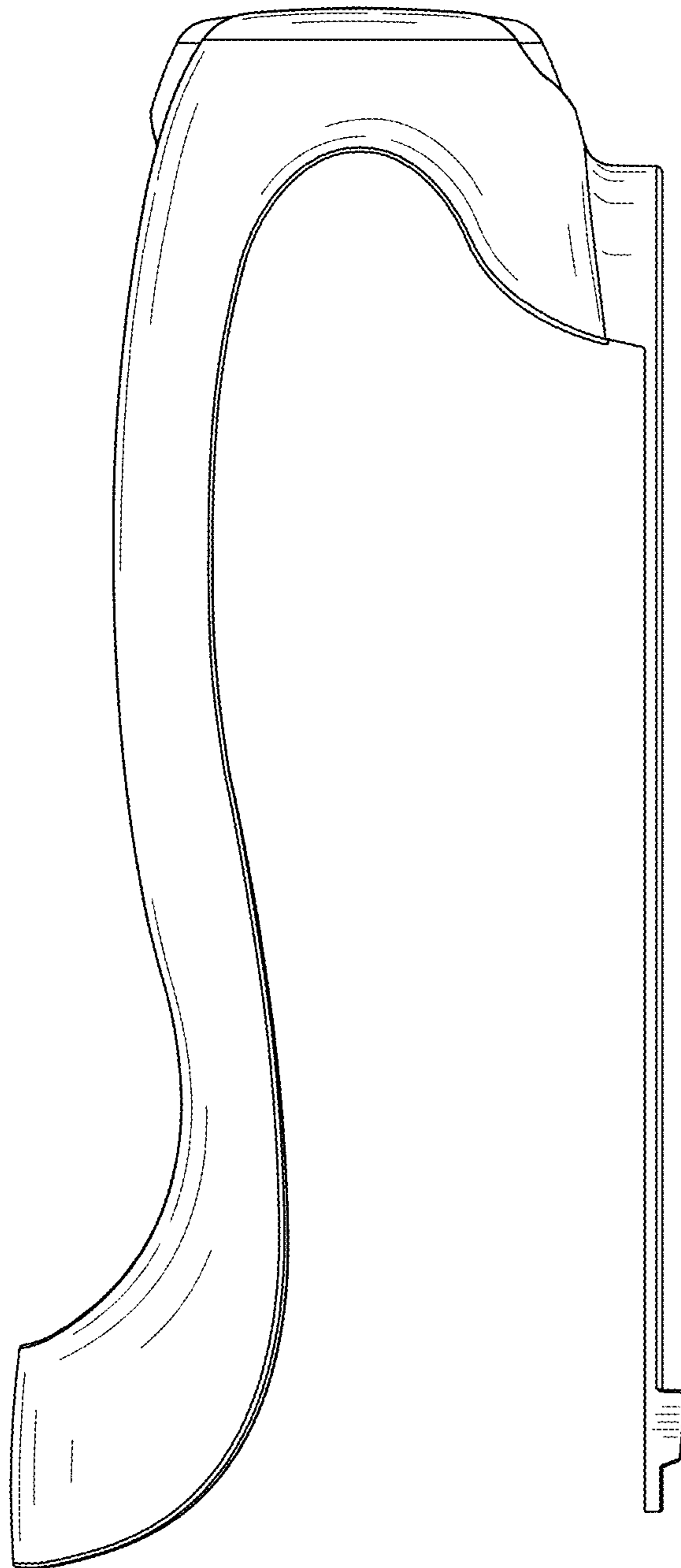

FIG. 4

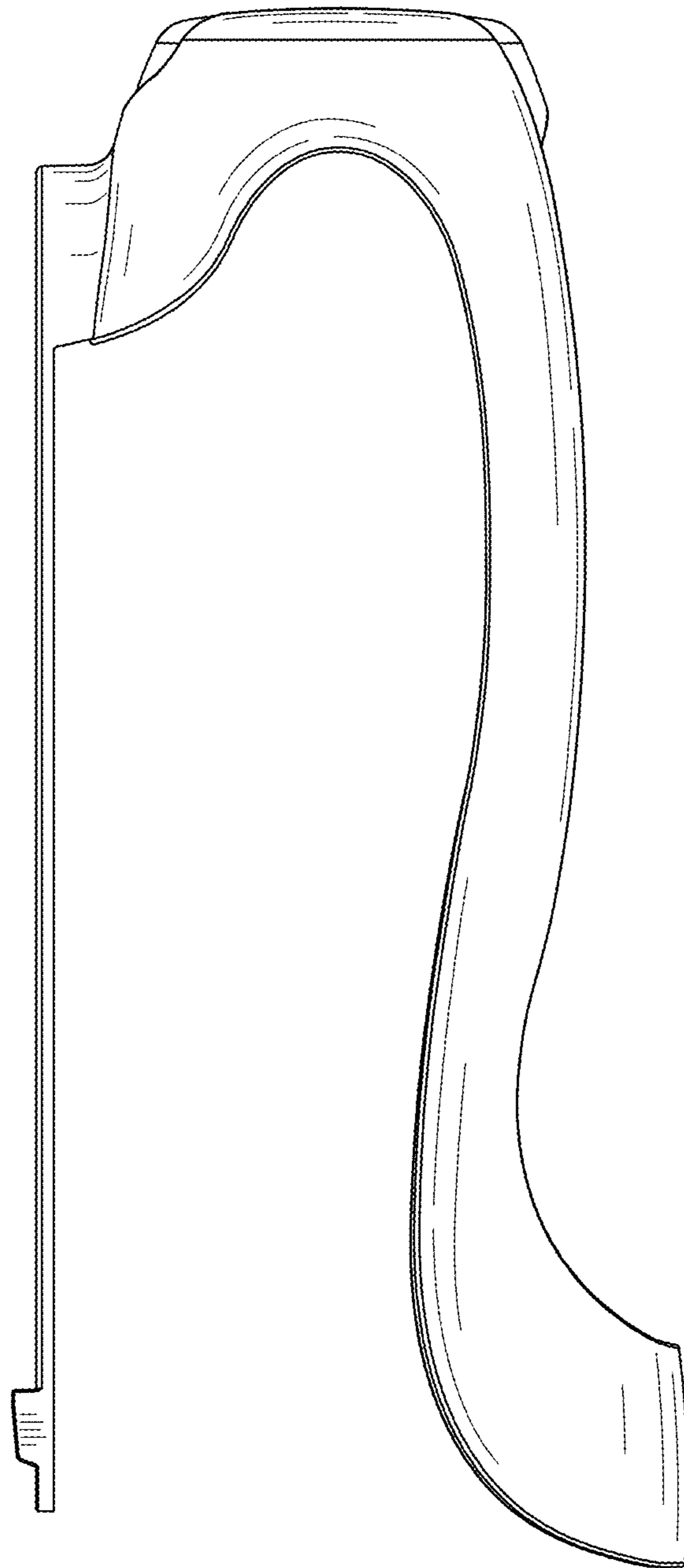

FIG. 5

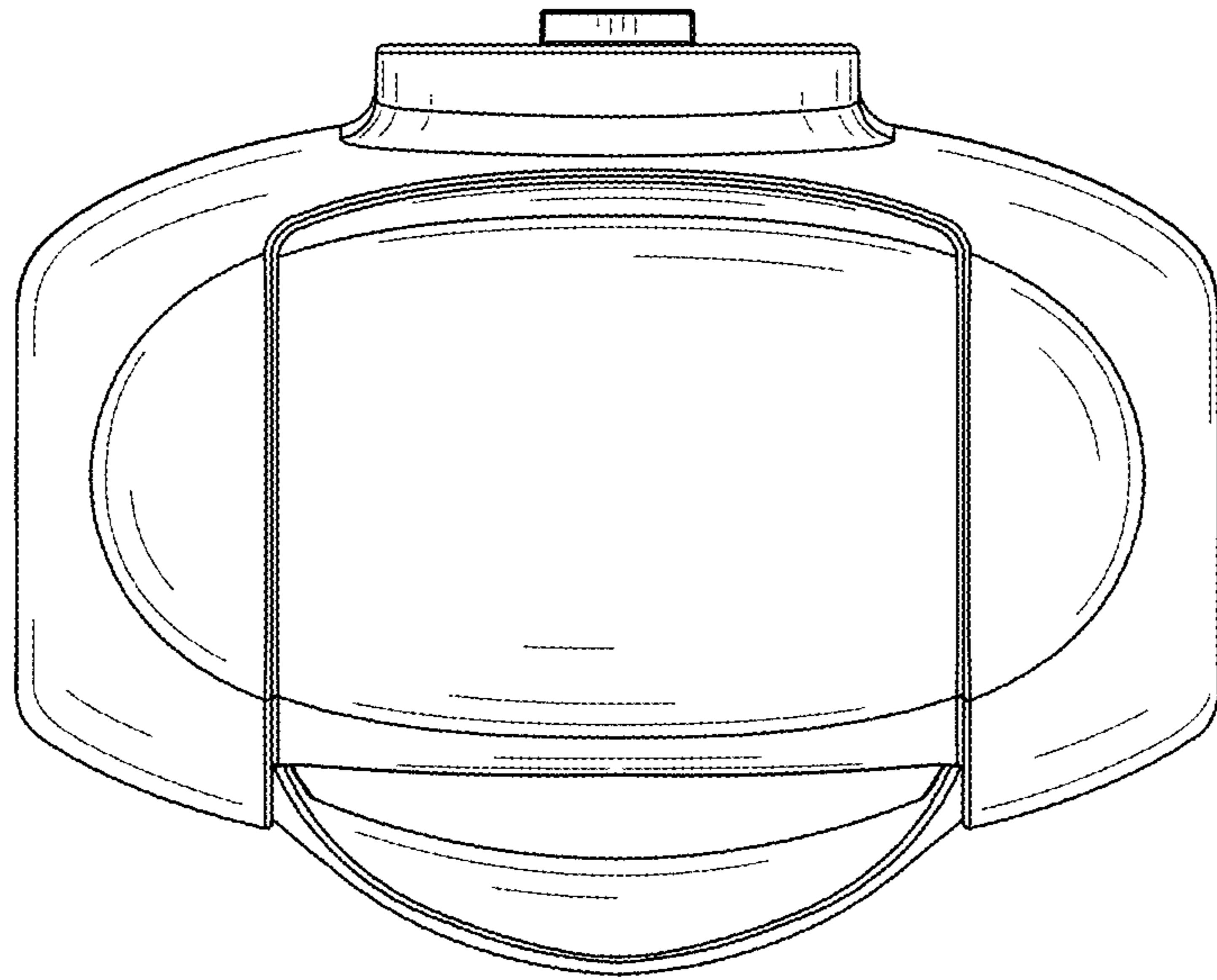

FIG. 6

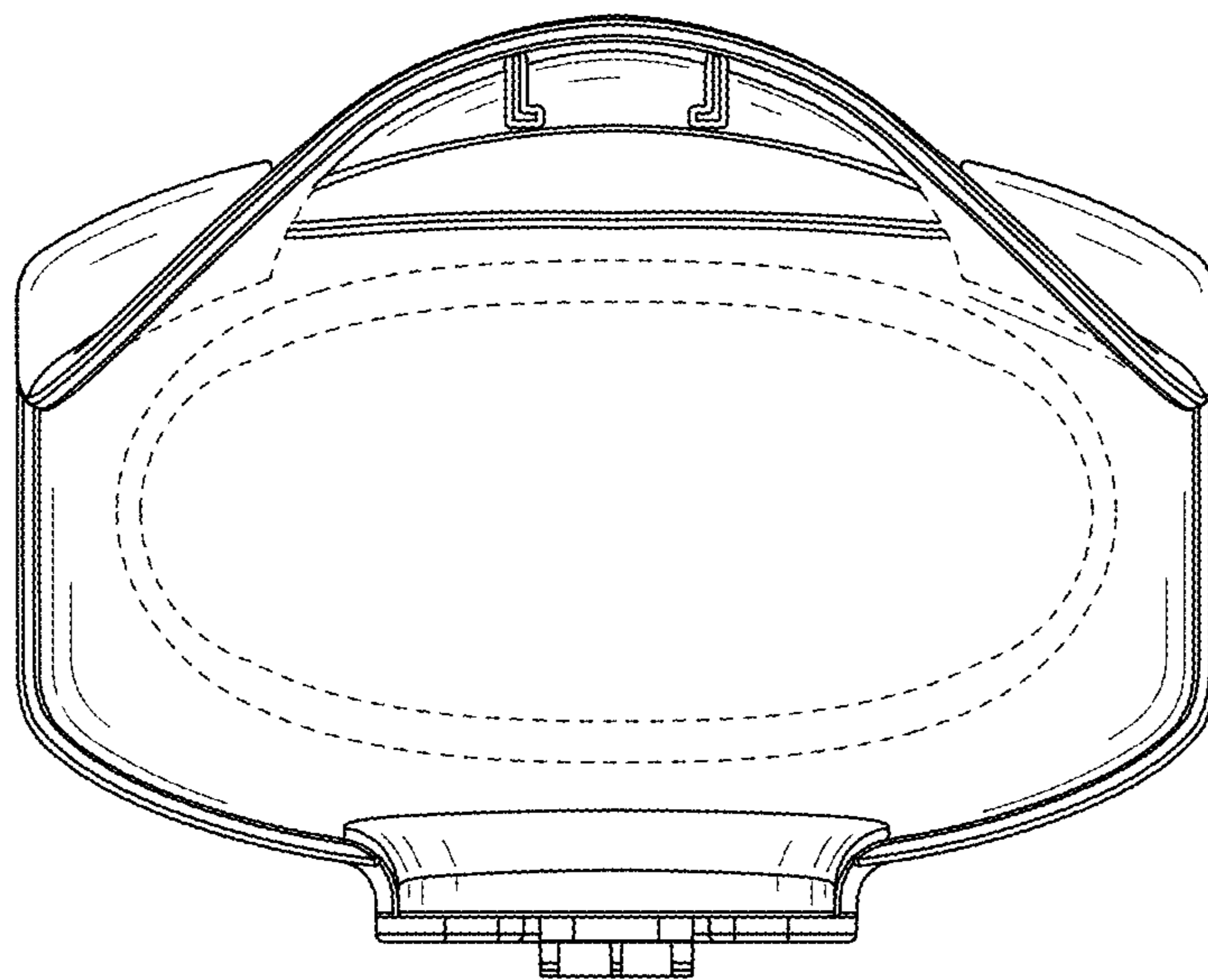

FIG. 7



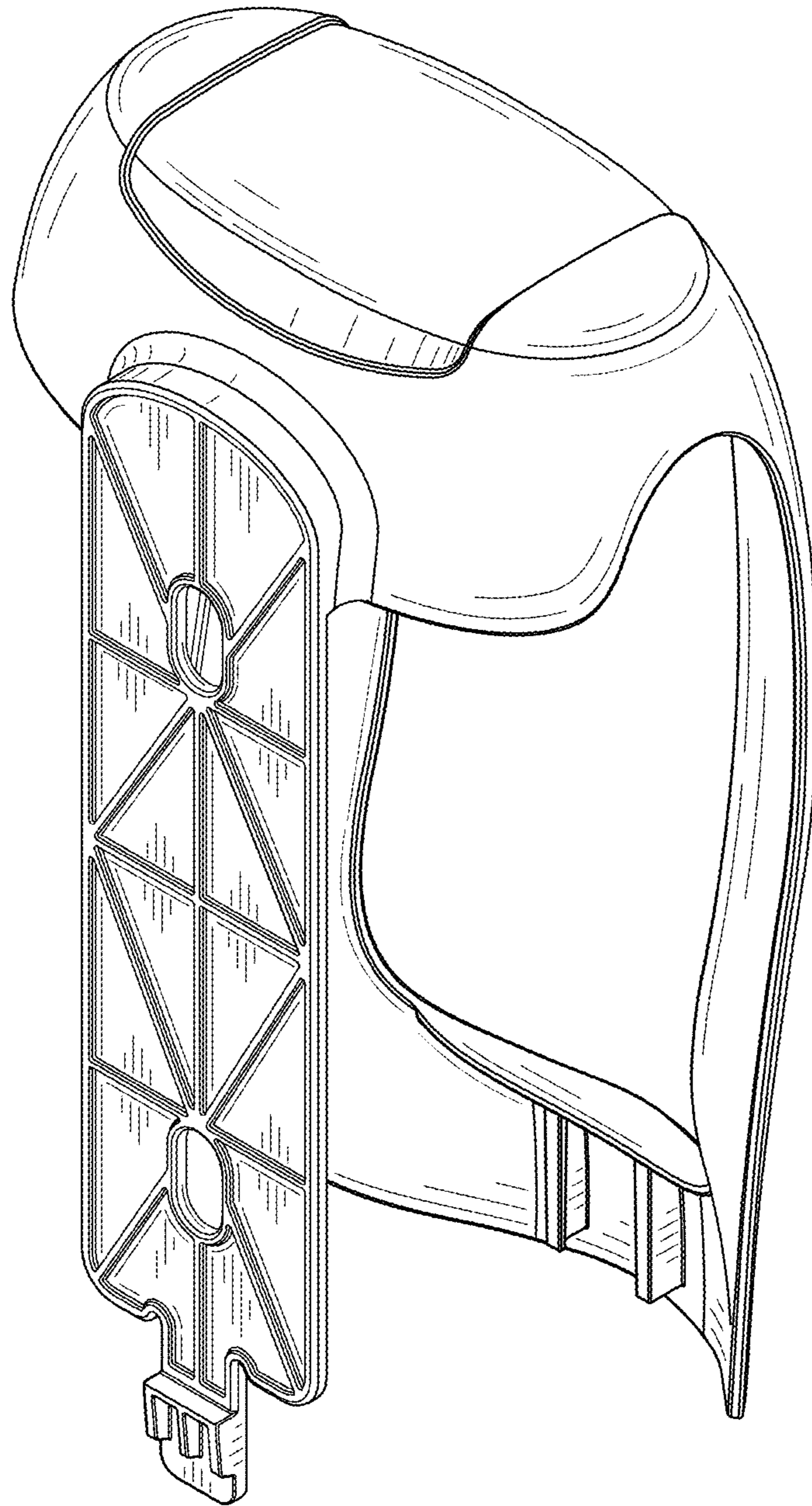

FIG. 8