



US00D781594S

(12) **United States Design Patent** (10) **Patent No.:** **US D781,594 S**
Löwe (45) **Date of Patent:** **** Mar. 21, 2017**

(54) **CLEANING BRUSH** 2200/1033; A46B 2200/104; A46B
2200/1046; A46B 2200/30; A46B
2200/3006; A46B

(71) Applicant: **Maschinenfabrik Heute GmbH & Co.** (Continued)
KG, Solingen (DE)

(72) Inventor: **Christian Löwe, Solingen (DE)**

(73) Assignee: **Maschinenfabrik Huete GmbH & Co.**
KG, Solingen (DE)

(**) Term: **15 Years**

(21) Appl. No.: **29/531,822**

(22) Filed: **Jun. 30, 2015**

(30) **Foreign Application Priority Data**

Dec. 30, 2014 (EM) 002607168-0003

(51) **LOC (10) Cl.** **04-01**

(52) **U.S. Cl.**
USPC **D4/130**

(58) **Field of Classification Search**
USPC D4/100, 102, 127-135, 138, 199;
D7/393; D8/47, 75, 82, 83, 107, 300,
D8/307-313; D9/723-729; D19/100,
D19/108, 115, 125; D24/200, 211, 214

CPC .. A46B 5/00; A46B 5/02; A46B 5/021; A46B
9/00; A46B 9/02; A46B 9/021; A46B
9/023; A46B 9/025; A46B 9/026; A46B
9/028; A46B 11/00; A46B 11/0006; A46B
11/001; A46B 13/00; A46B 13/001; A46B
13/02; A46B 13/023; A46B 15/0002;
A46B 2200/10; A46B 2200/102; A46B

(56) **References Cited**

U.S. PATENT DOCUMENTS

D43,181 S * 10/1912 Scheuer D4/130
1,425,906 A * 8/1922 Sherbondy A46B 13/001
15/182

(Continued)

FOREIGN PATENT DOCUMENTS

CA 2095399 A1 * 11/1994 A46B 13/001
DE 29501953 U1 * 8/1995 A46B 5/00

(Continued)

OTHER PUBLICATIONS

OriginalGaloMat, "ProfilGate Tire Cleaning short version," posted at YouTube [online], posting date Jun. 21, 2009 [site visited Mar. 15, 2016]. Available from the Internet, <URL: <https://www.youtube.com/watch?v=bJfRvVO4BG4>>.*

Primary Examiner — Catheri Oliver-Garcia

Assistant Examiner — Rebekah A Caruso

(74) *Attorney, Agent, or Firm* — Cahn & Samuels, LLP

(57) **CLAIM**

The ornamental design for a cleaning brush, as shown and described.

DESCRIPTION

FIG. 1 is a partial top view of a cleaning brush according to the present invention.

FIG. 2 is a perspective view of the cleaning brush.

FIG. 3 is a bottom perspective view of the cleaning brush.

FIG. 4 is a side view of the cleaning brush.

FIG. 5 is a front view of the cleaning brush.

FIG. 6 is a partial bottom view of the cleaning brush.

FIG. 7 is a top view of the cleaning brush; and,

FIG. 8 is a bottom view of the cleaning brush.

1 Claim, 5 Drawing Sheets

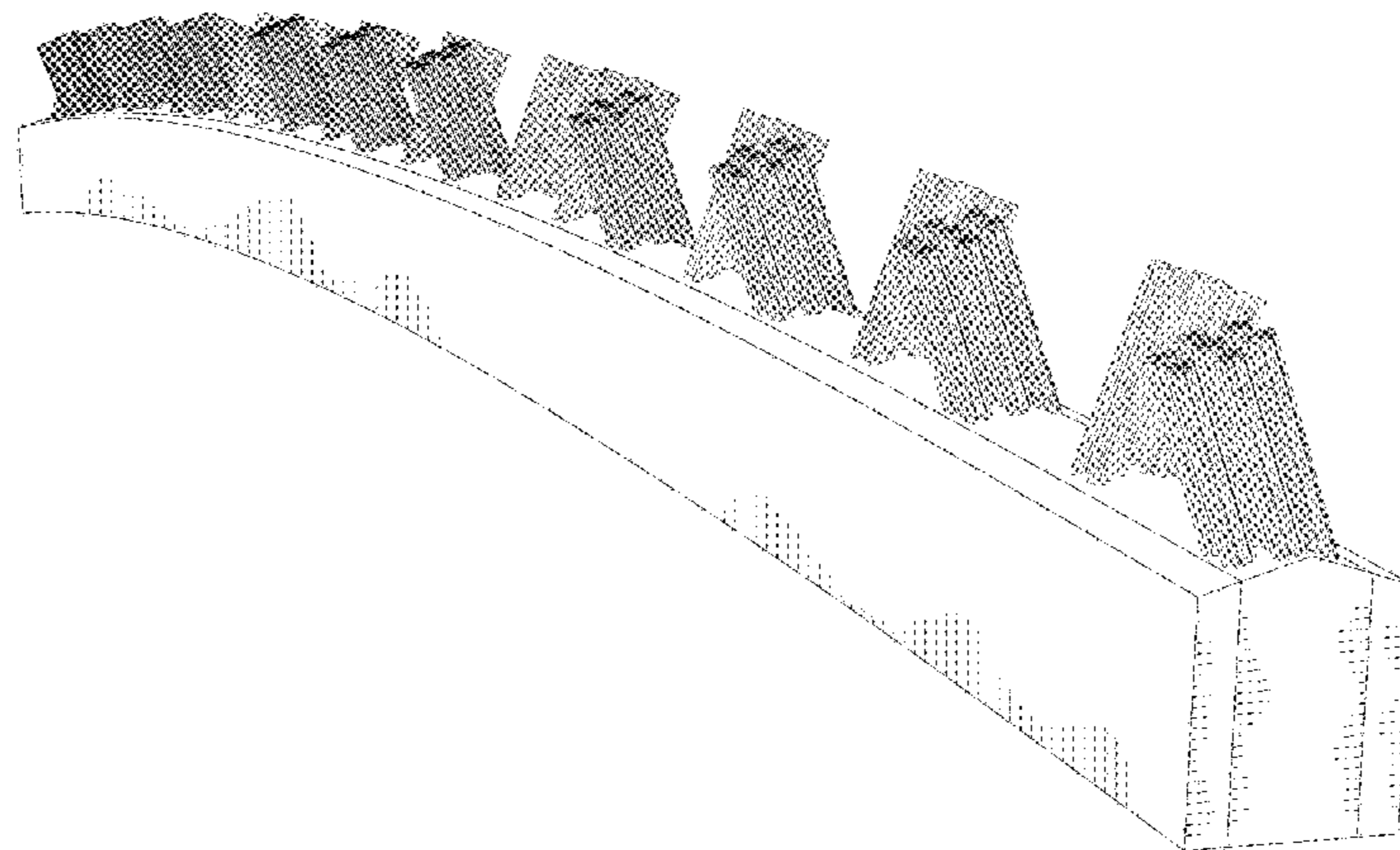

US D781,594 S

Page 2

(58) **Field of Classification Search**

CPC 2200/3013; A46B 2200/3033; A46B
2200/3093

See application file for complete search history.

D518,258 S * 3/2006 Hamm D32/31
7,937,793 B1 * 5/2011 Gilbert B60S 3/042
15/36
D668,877 S * 10/2012 Pires D4/133
2014/0237745 A1 * 8/2014 Hsu A46B 9/023
15/160
2016/0069158 A1 * 3/2016 Coyle, Jr. E21B 37/02
15/104.05

(56) **References Cited**

U.S. PATENT DOCUMENTS

4,037,285 A * 7/1977 Bottos A46B 5/00
15/143.1
4,307,479 A * 12/1981 Mertes A46B 7/04
15/182
D396,909 S * 8/1998 Carter D21/789
6,530,106 B1 * 3/2003 Brundula A47L 9/0477
15/179

FOREIGN PATENT DOCUMENTS

FR 774234 A * 12/1934 A46B 5/02
SE WO 2016114709 A1 * 7/2016 A46B 3/16

* cited by examiner

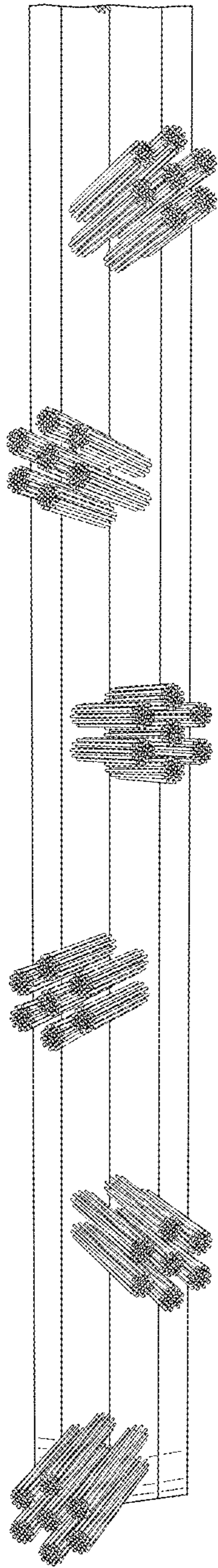

FIG. 1

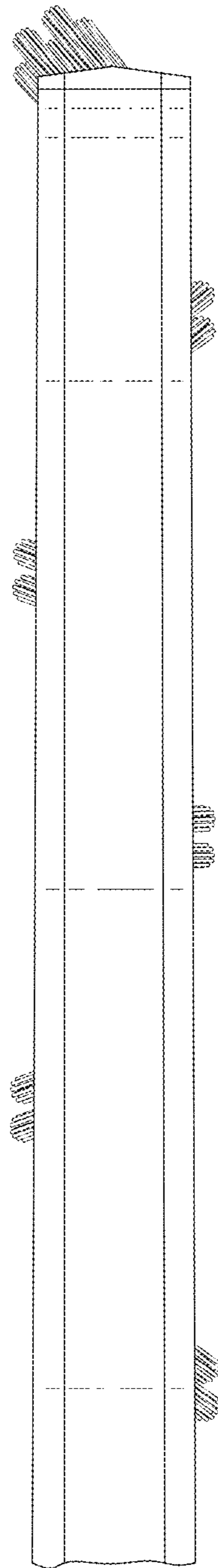

FIG. 6

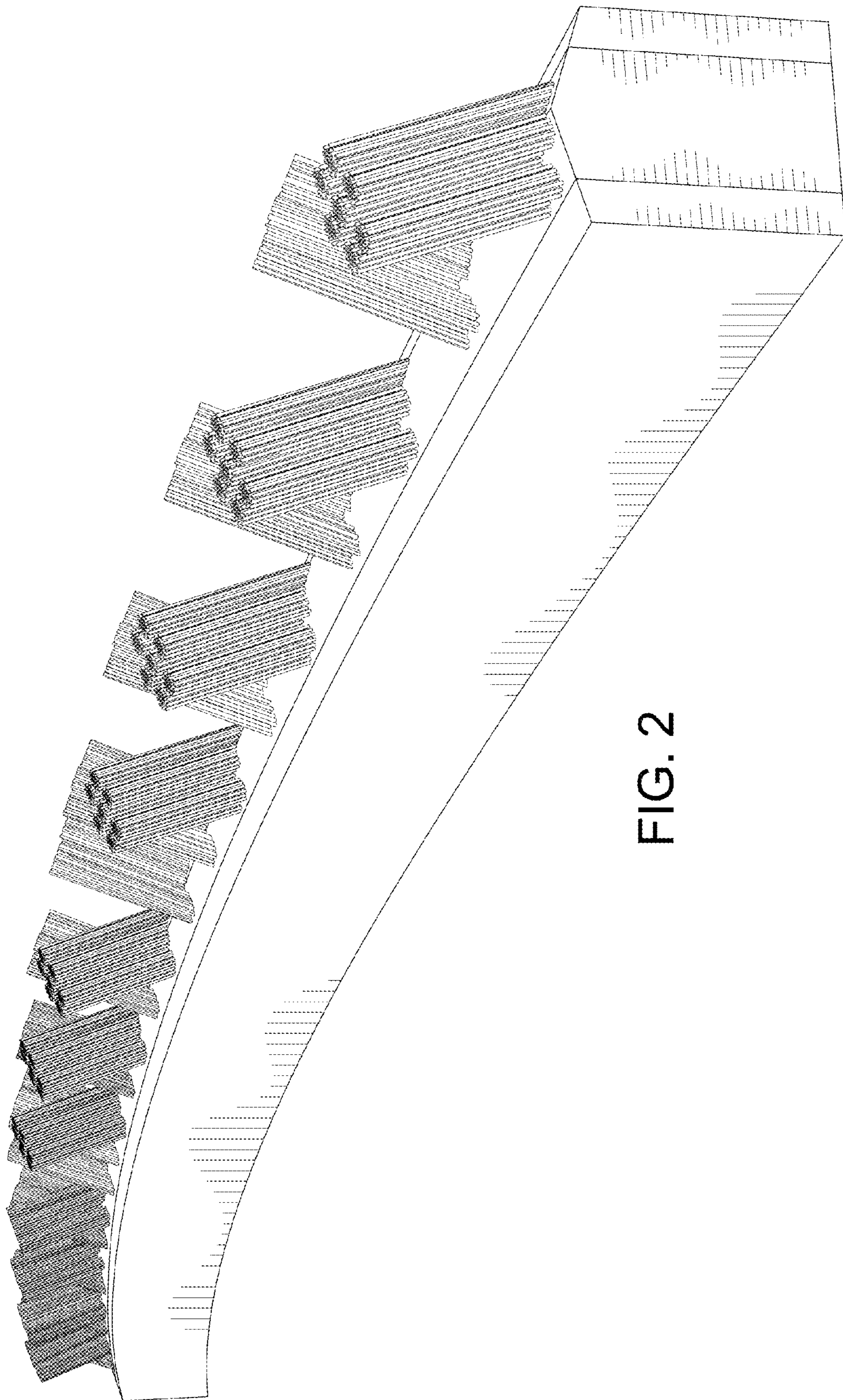

FIG. 2

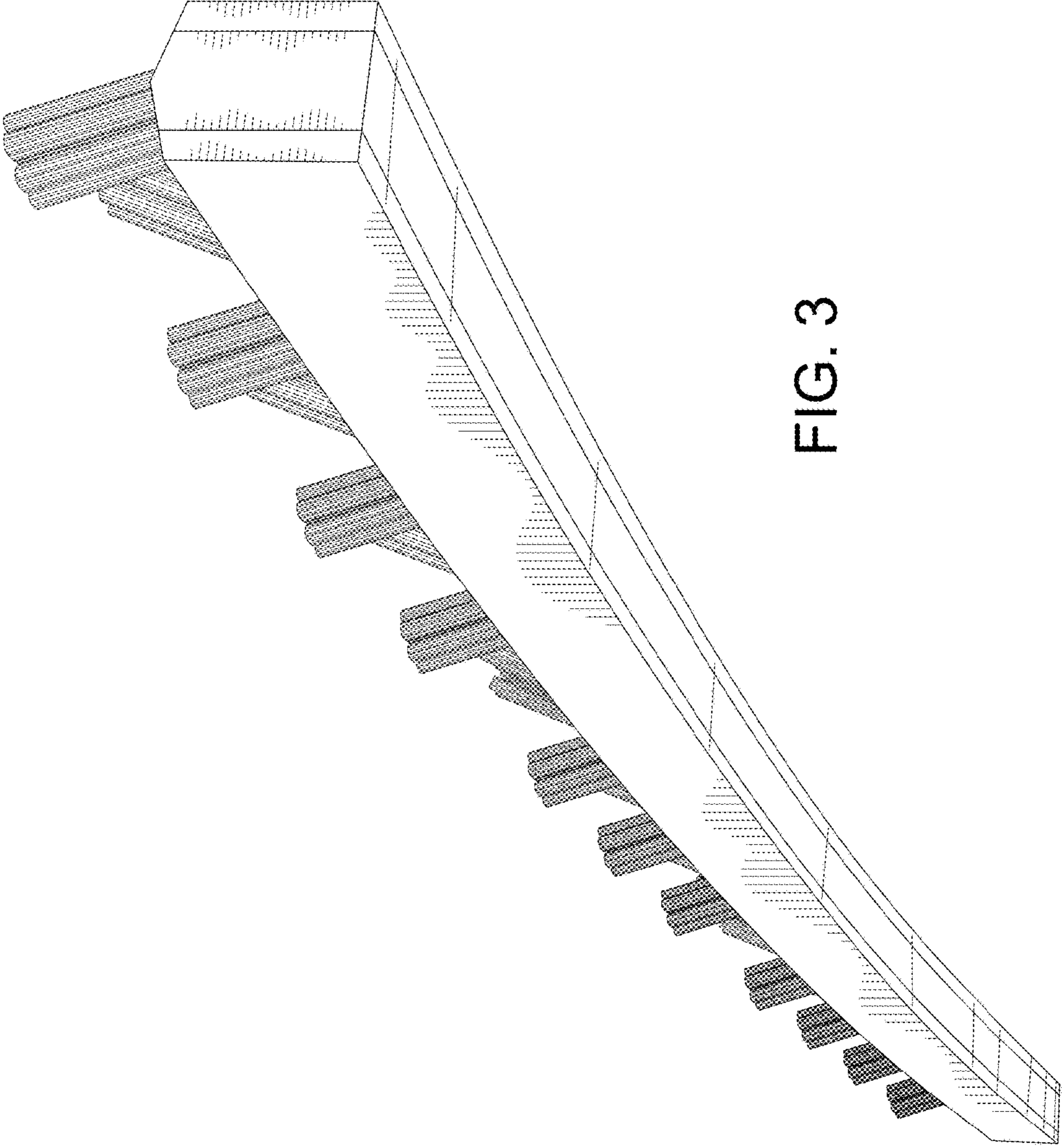

FIG. 3

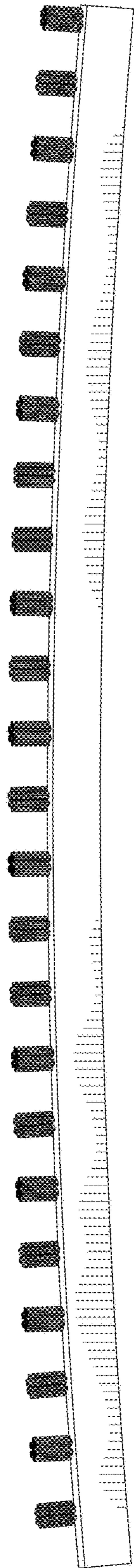

FIG. 4

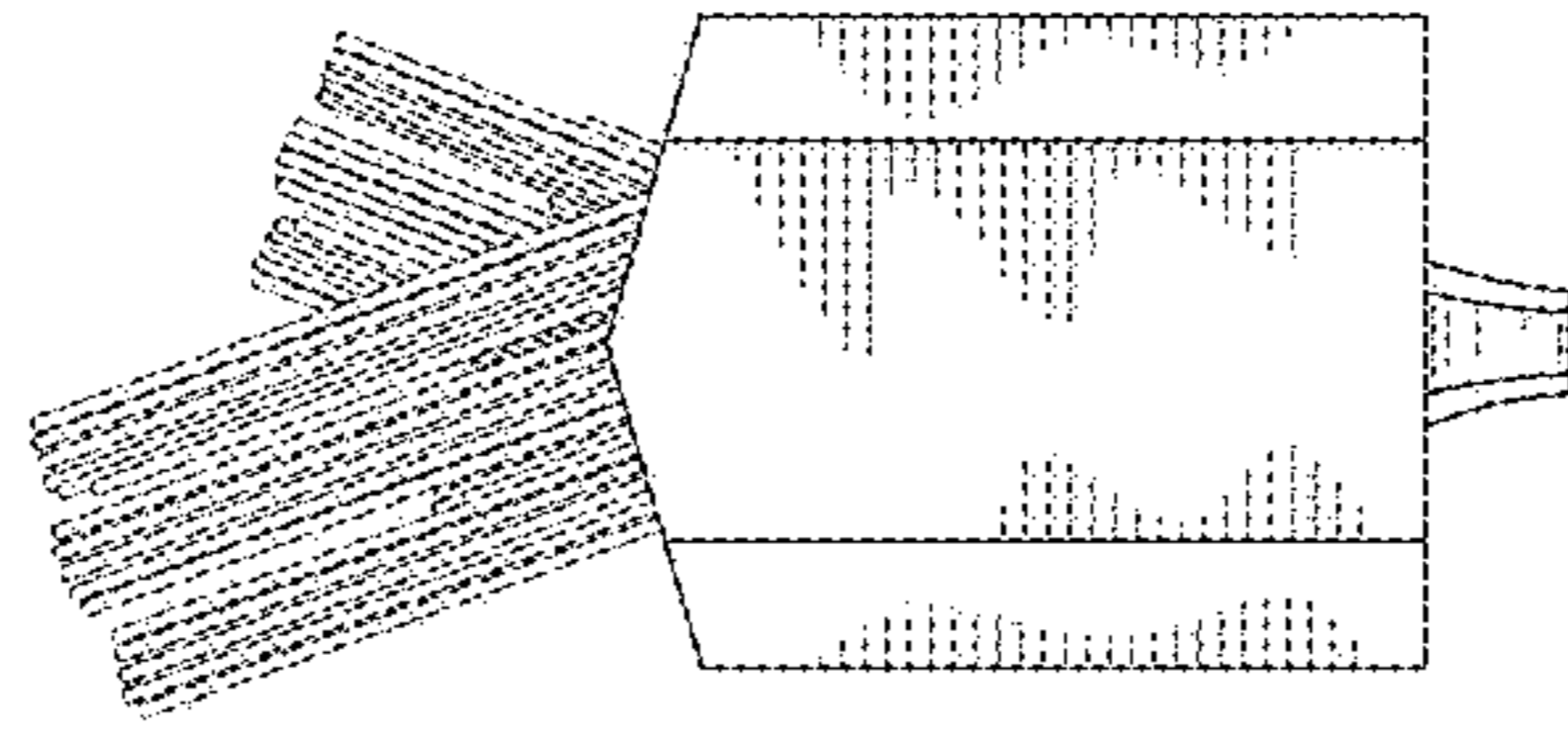

FIG. 5

FIG. 7



FIG. 8



UNITED STATES PATENT AND TRADEMARK OFFICE
CERTIFICATE OF CORRECTION

PATENT NO. : D781,594 S
APPLICATION NO. : 29/531822
DATED : March 21, 2017
INVENTOR(S) : Christian Löwe

Page 1 of 1

It is certified that error appears in the above-identified patent and that said Letters Patent is hereby corrected as shown below:

On the Title Page

Item (73), Assignee:

Change "Maschinenfabrik Huete GmbH & Co. KG, Solingen (DE)"

To:

--Maschinenfabrik Heute GmbH & Co. KG, Solingen (DE)--.

Signed and Sealed this
Seventh Day of November, 2017



Joseph Matal

*Performing the Functions and Duties of the
Under Secretary of Commerce for Intellectual Property and
Director of the United States Patent and Trademark Office*

UNITED STATES PATENT AND TRADEMARK OFFICE
CERTIFICATE OF CORRECTION

PATENT NO. : D781,594 S
APPLICATION NO. : 29/531822
DATED : March 21, 2017
INVENTOR(S) : Christian Lowe et al.

Page 1 of 1

It is certified that error appears in the above-identified patent and that said Letters Patent is hereby corrected as shown below:

A petition under 3.81(b) is required to correct the assignee. The Certificate of Correction which issued on November 7, 2017 was published in error and should not have been issued for this patent. The Certificate of Correction is vacated and the patent is returned to its original state.

Signed and Sealed this
Fifth Day of June, 2018

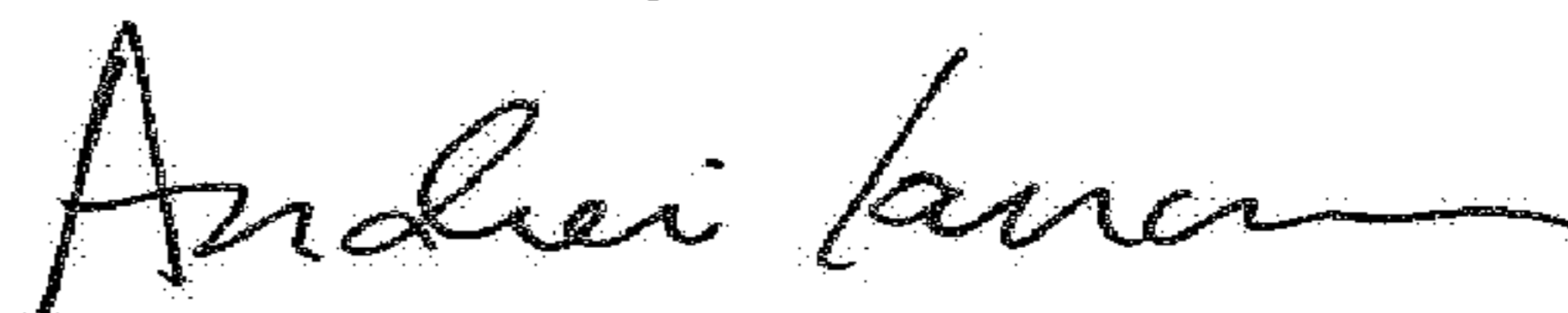

Andrei Iancu
Director of the United States Patent and Trademark Office

UNITED STATES PATENT AND TRADEMARK OFFICE
CERTIFICATE OF CORRECTION

PATENT NO. : D781,594 S
APPLICATION NO. : 29/531822
DATED : March 21, 2017
INVENTOR(S) : Christian Löwe

Page 1 of 1

It is certified that error appears in the above-identified patent and that said Letters Patent is hereby corrected as shown below:

On the Title Page

Item (73), Assignee:

Change "Maschinenfabrik Huete GmbH & Co. KG, Solingen (DE)"

To:

--Maschinenfabrik Heute GmbH & Co. KG, Solingen (DE)--.

Signed and Sealed this
Seventh Day of August, 2018

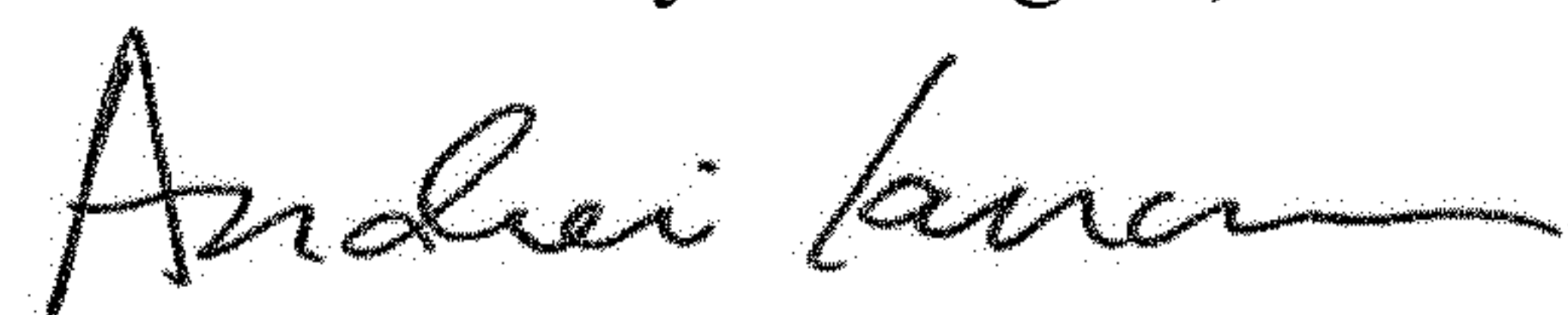

Andrei Iancu
Director of the United States Patent and Trademark Office