



US00D781593S

(12) **United States Design Patent** (10) **Patent No.:** **US D781,593 S**
Kaicker (45) **Date of Patent:** **** Mar. 21, 2017**

(54) **COSMETICS BRUSH**

(71) Applicant: **ANISA INTERNATIONAL, INC.**,
Atlanta, GA (US)

(72) Inventor: **Anisa Telwar Kaicker**, Atlanta, GA
(US)

(73) Assignee: **ANISA INTERNATIONAL, INC.**,
Atlanta, GA (US)

5,891,063 A * 4/1999 Vigil A46B 13/02
15/207.2

D452,994 S 1/2002 Mink
7,275,885 B2 * 10/2007 Byun A45D 33/02
401/278

(Continued)

FOREIGN PATENT DOCUMENTS

EM 002978676-0001 2/2016
EM 002978676-0002 2/2016

(Continued)

Primary Examiner — Karen E Eldridge Powers
(74) *Attorney, Agent, or Firm* — Gronholm Patent
Services

(**) Term: **14 Years**

(21) Appl. No.: **29/525,204**

(22) Filed: **Apr. 28, 2015**

(51) **LOC (10) Cl.** **04-02**

(52) **U.S. Cl.**
USPC **D4/128**

(58) **Field of Classification Search**
USPC D4/114, 119, 129, 130, 135, 136, 138,
D4/139, 199; D24/211, 215; D32/19, 40,
D32/46, 52, 132; 15/106, 143.1, 146,
15/159.1, 160, 186, 187
CPC A46B 15/0093; A46B 2200/1046; A46B
7/04; A46B 7/044; A46B 5/0016; A46B
9/021; A45D 33/36

See application file for complete search history.

(56) **References Cited**

U.S. PATENT DOCUMENTS

1,120,476 A 12/1914 Hansen
1,694,364 A * 12/1928 Albright A46B 15/00
15/159.1

2,662,240 A 10/1948 Perkins
3,471,202 A 10/1969 Lewis
3,596,999 A 8/1971 Lewis
3,604,043 A 9/1971 Lewis
4,842,132 A 6/1989 Wells
4,998,315 A * 3/1991 Pessis A45D 40/265
132/320

(57) **CLAIM**

The ornamental design for a cosmetics brush, as shown and described.

DESCRIPTION

FIG. 1 is a top perspective view of a cosmetics brush according to an embodiment of the present design;
FIG. 2 is a left side elevational view of the cosmetics brush shown in FIG. 1;
FIG. 3 is a right side elevational view of the cosmetics brush shown in FIG. 1;
FIG. 4 is a front side elevational view of the cosmetics brush shown in FIG. 1;
FIG. 5 is a rear elevational view of the cosmetics brush shown in FIG. 1;
FIG. 6 is a top plan view of the cosmetics brush shown in FIG. 1; and,
FIG. 7 is a bottom plan view of the cosmetics brush shown in FIG. 1.

The broken lines shown in the drawings illustrate environmental structure that forms no part of the claimed design.

1 Claim, 3 Drawing Sheets

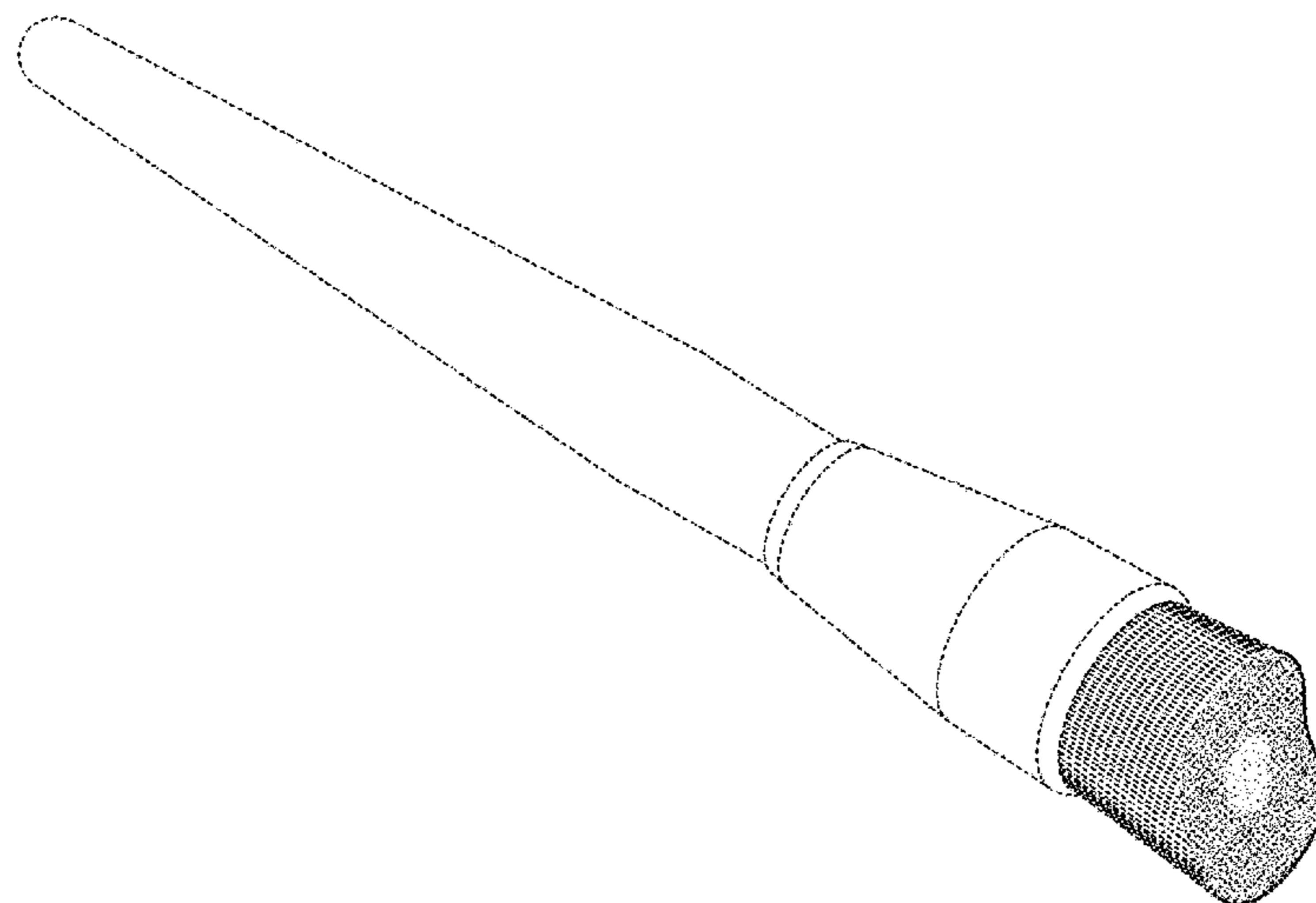

(56)

References Cited

U.S. PATENT DOCUMENTS

D566,969 S 4/2008 Sherman
 7,503,093 B2* 3/2009 Weihrauch A46B 3/22
 15/167.1
 7,866,758 B2 1/2011 Jang
 8,060,971 B1* 11/2011 Castelluccio A46B 5/0091
 15/160
 8,104,132 B2 1/2012 Mink
 8,230,543 B2 7/2012 Shrier
 8,256,058 B2 9/2012 Telwar
 D679,506 S 4/2013 Hile
 D730,062 S* 5/2015 Lim D4/138
 9,089,200 B2* 7/2015 Telwar A46B 3/08
 9,320,349 B2* 4/2016 Hwang A46B 9/021
 2002/0124336 A1 9/2002 Henrie
 2004/0168700 A1 9/2004 Dorf
 2006/0150355 A1* 7/2006 Mason A46B 7/04
 15/166
 2007/0151061 A1* 7/2007 Mink A46B 9/021
 15/160
 2009/0038094 A1* 2/2009 Kim A45D 34/042
 15/160
 2009/0183328 A1* 7/2009 King A46B 5/0062
 15/143.1
 2010/0095973 A1 4/2010 Shrier

2010/0101035 A1 4/2010 Nakamura
 2012/0034018 A1* 2/2012 Freeman A46B 11/063
 401/270
 2012/0227197 A1* 9/2012 Fleischer A46B 7/04
 15/105
 2014/0166041 A1* 6/2014 King A46B 9/021
 132/320
 2014/0325779 A1* 11/2014 Dansby A46B 17/02
 15/168
 2014/0331422 A1* 11/2014 Lim A45D 40/262
 15/106
 2015/0374109 A1* 12/2015 Wilson A46B 9/025
 15/160
 2016/0037901 A1* 2/2016 Telwar A46B 3/08
 15/106

FOREIGN PATENT DOCUMENTS

EM 002978676-0003 2/2016
 EM 002978676-0004 2/2016
 EM 002978676-0005 2/2016
 EM 002978676-0006 2/2016
 GB 2238467 5/1991
 JP 2006-075329 3/2006
 JP 2008-168108 7/2008

* cited by examiner

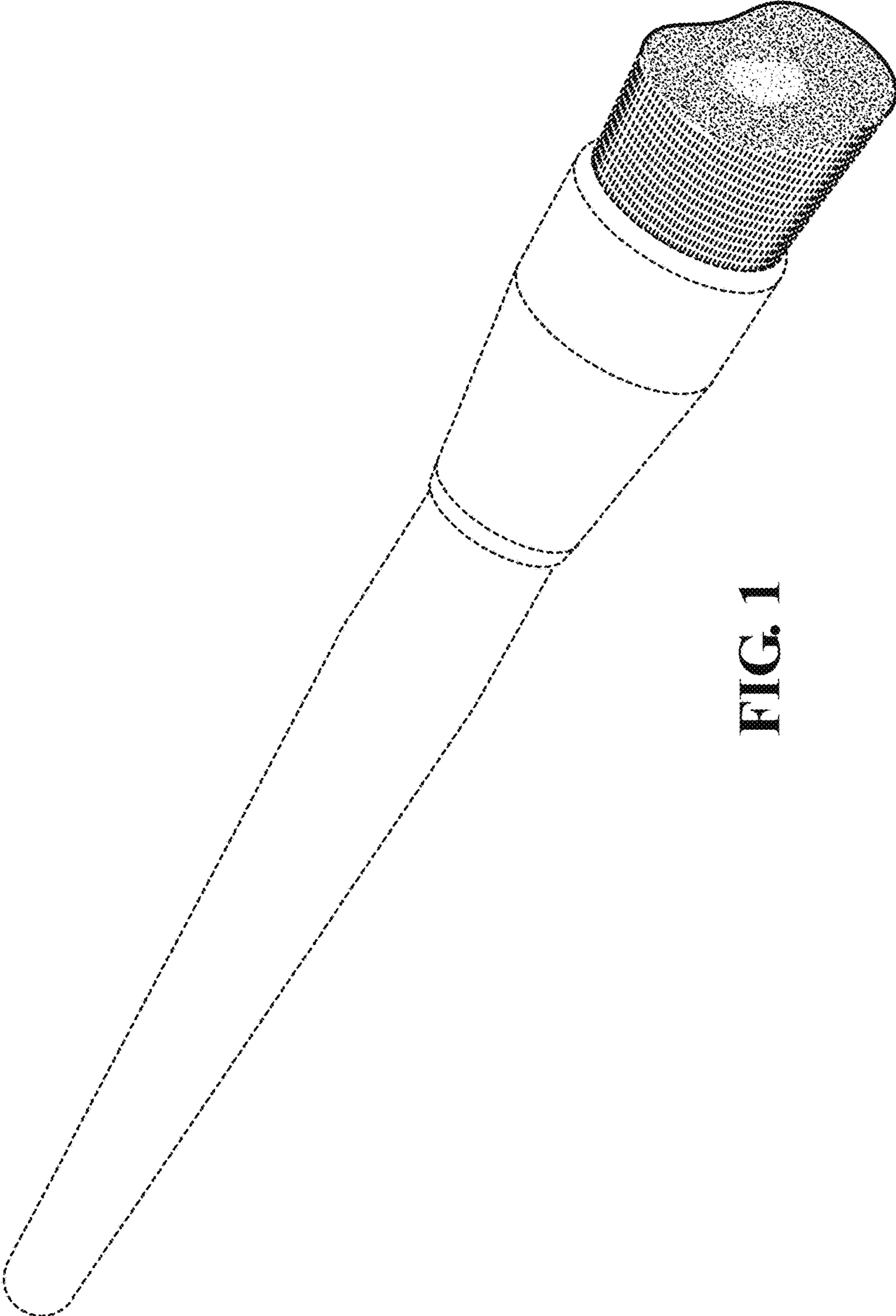

FIG. 1

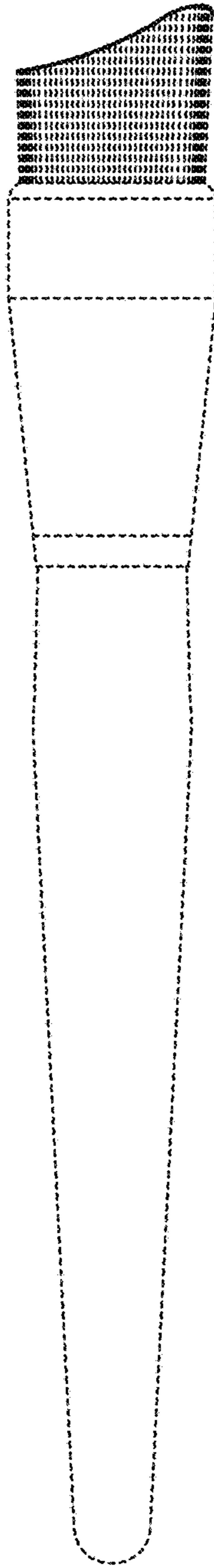

FIG. 2

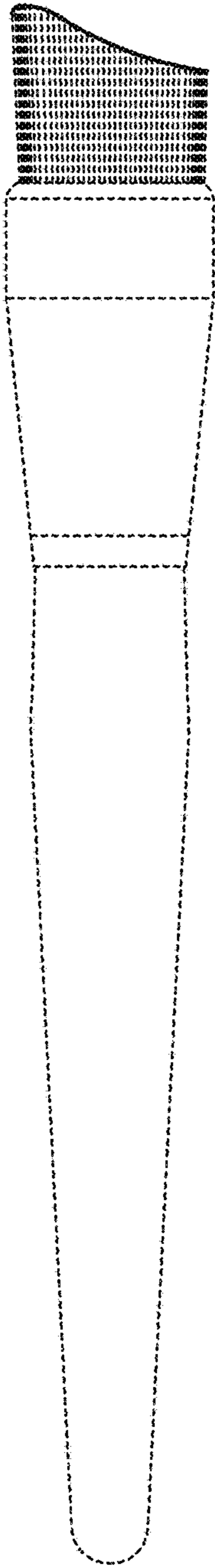

FIG. 3

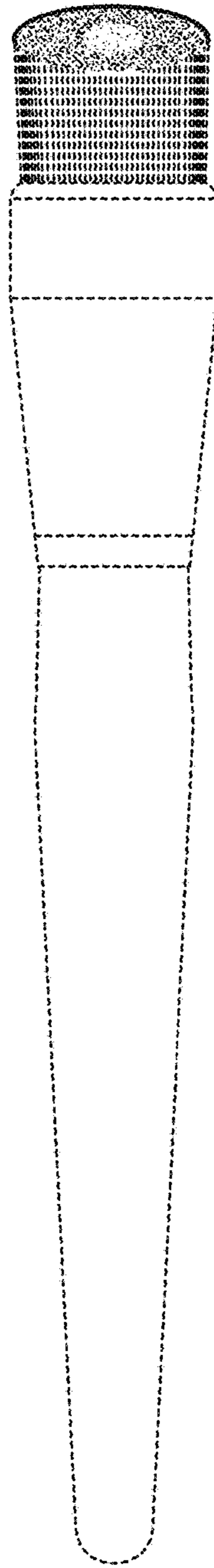

FIG. 4

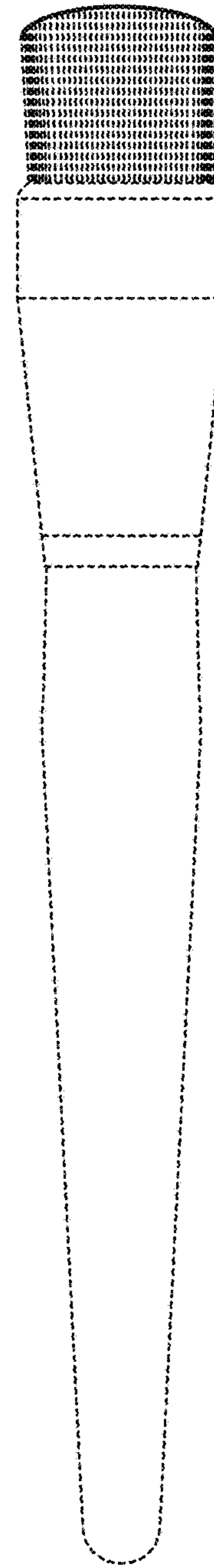

FIG. 5

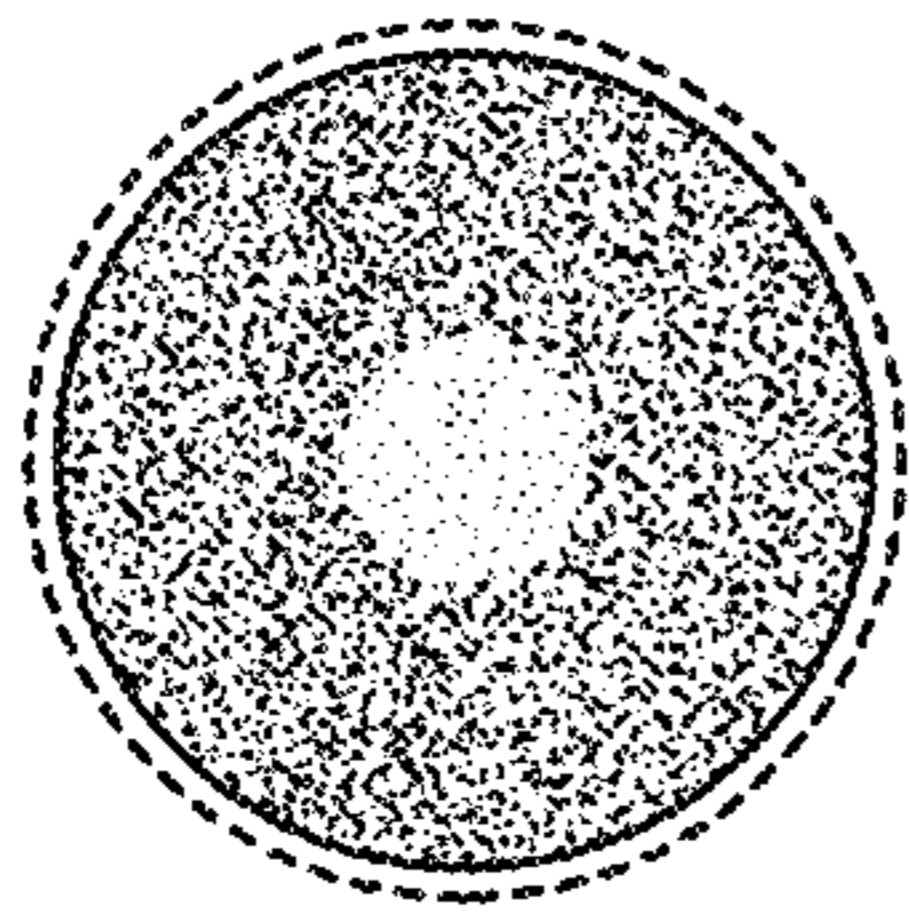

FIG. 6

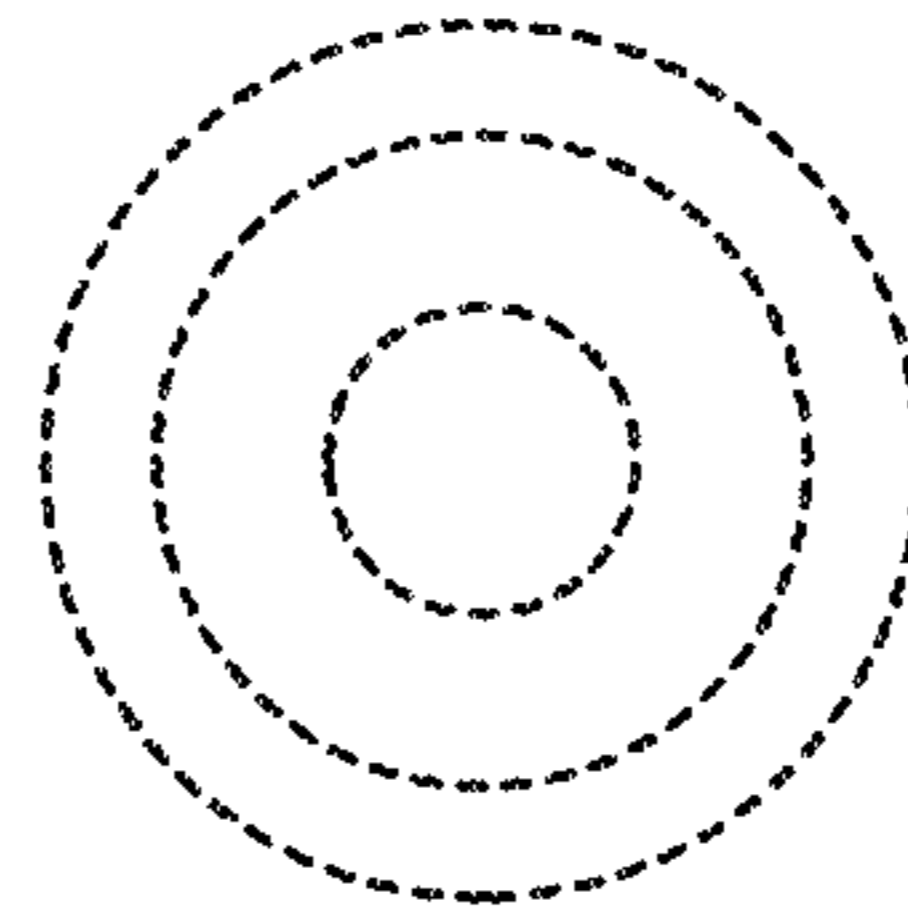

FIG. 7