

US00D781453S

(12) **United States Design Patent** (10) **Patent No.:** **US D781,453 S**  
**Gomez** (45) **Date of Patent:** **\*\* Mar. 14, 2017**

(54) **STAGE PLATFORM**  
(71) Applicant: **Stage FX, Inc.**, LaPuente, CA (US)  
(72) Inventor: **Adrian Gomez**, LaPuente, CA (US)  
(\*\*) Term: **15 Years**  
(21) Appl. No.: **29/547,488**  
(22) Filed: **Dec. 4, 2015**  
(51) **LOC (10) Cl.** ..... **25-04**  
(52) **U.S. Cl.**  
USPC ..... **D25/68**  
(58) **Field of Classification Search**  
USPC ..... D25/62-69, 38.1, 152, 156, 157, 158;  
182/222, 179.1, 84, 88, 112, 116, 102,  
182/123, 130, 150; 52/7, 126.7, 127.6,  
52/87, 634, 650.3, 630; 211/153, 134,  
211/150, 182, 90.01, 119.03, 195, 90.02;  
108/42, 147.17, 48; 248/250, 207;  
312/408, 410; D8/382, 381, 380, 363,  
D8/354; D6/570, 566, 567, 568, 569,  
D6/682, 574, 573, 572, 571, 652.1,  
D6/653.11, 661, 674, 678.1, 705  
CPC . E04H 3/28; E04H 3/26; B60R 3/007; A01M  
31/02; A01M 31/025; E06C 7/16  
See application file for complete search history.

D596,317 S 7/2009 Favell  
D602,603 S \* 10/2009 Masser ..... D25/68  
D608,459 S \* 1/2010 Wyse ..... D25/35  
D621,525 S \* 8/2010 Cook ..... D25/62  
8,640,388 B2 2/2014 Favell  
8,769,908 B1 \* 7/2014 Santini ..... E04C 2/38  
446/123  
8,978,310 B2 3/2015 Chase et al.  
D737,464 S 8/2015 Edlington  
2013/0055647 A1 3/2013 Favell  
2013/0086864 A1 \* 4/2013 Marriott ..... E04F 15/02161  
52/650.3  
2014/0069026 A1 3/2014 Parker  
2015/0013236 A1 1/2015 Parker  
2015/0257530 A1 \* 9/2015 Naka ..... A47B 47/0091  
211/188

**OTHER PUBLICATIONS**

StageFXInc. "Stage FX", www.stagefxinc.com. FX-DECK. Web.  
Jan. 18, 2017. shown in p. 1. Item FX-Deck.\*

\* cited by examiner

*Primary Examiner* — Cynthia Ramirez  
*Assistant Examiner* — Gino Colan  
(74) *Attorney, Agent, or Firm* — Traverse Legal, PLC

(57) **CLAIM**

I claim a new ornamental design for a stage platform, as shown and described.

(56) **References Cited**

**U.S. PATENT DOCUMENTS**

2,668,331 A \* 2/1954 Horn ..... A63J 1/00  
108/115  
5,205,087 A \* 4/1993 Jines ..... E04H 3/28  
52/126.5  
5,927,437 A \* 7/1999 Fast ..... A01M 31/02  
182/187  
6,945,002 B2 \* 9/2005 Zambelli ..... E04C 2/384  
52/601  
7,398,626 B2 7/2008 Greschbach  
D596,314 S 7/2009 Parsons

**DESCRIPTION**

FIG. 1 is a top-side perspective view of a stage platform showing my new design;  
FIG. 2 is a front elevation view thereof;  
FIG. 3 is a front perspective view thereof;  
FIG. 4 is a side elevational view thereof;  
FIG. 5 is a top plan view thereof;  
FIG. 6 is a top perspective view thereof; and,  
FIG. 7 is a bottom plan view thereof.

**1 Claim, 5 Drawing Sheets**

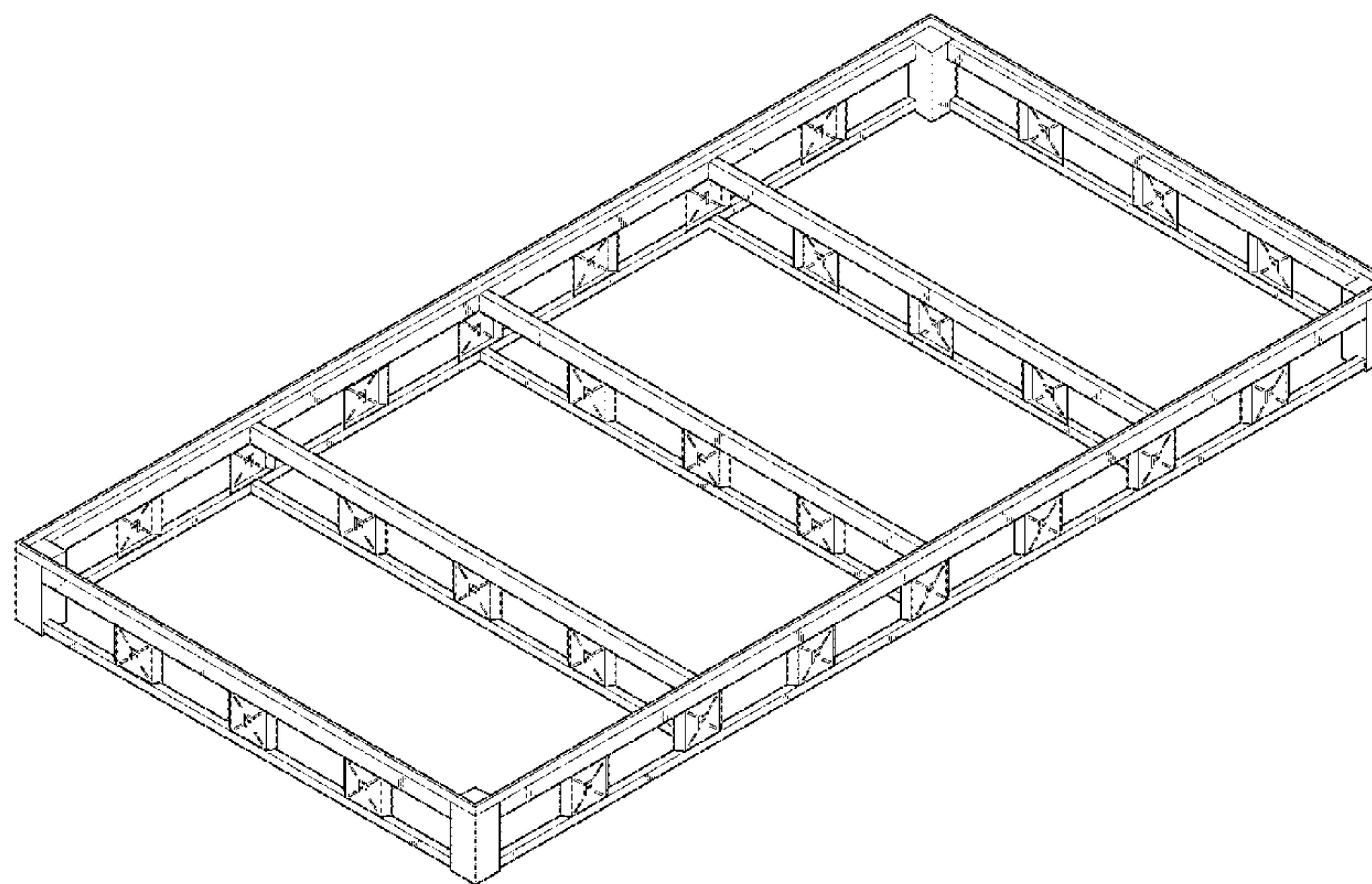

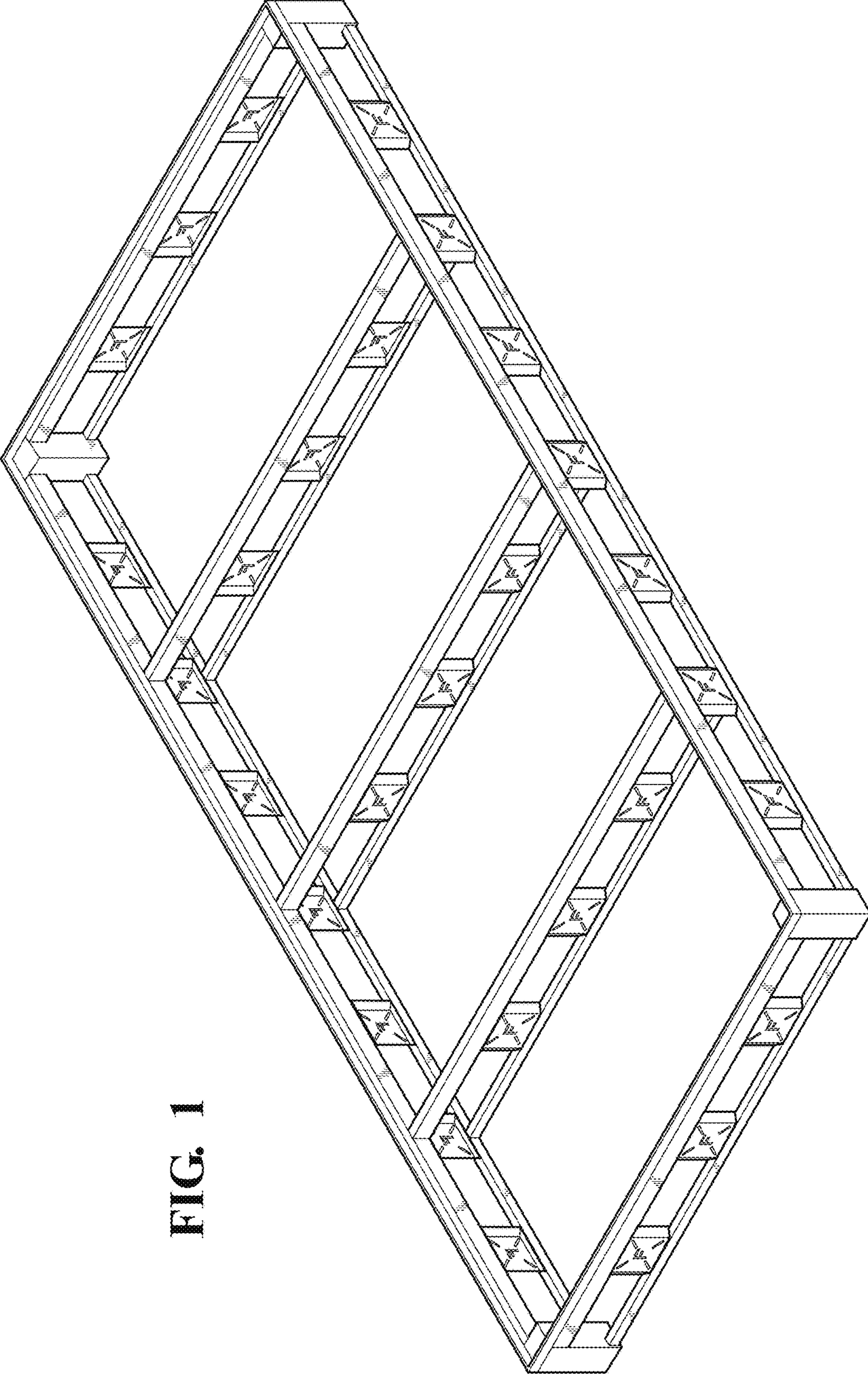

FIG. 1



FIG. 2

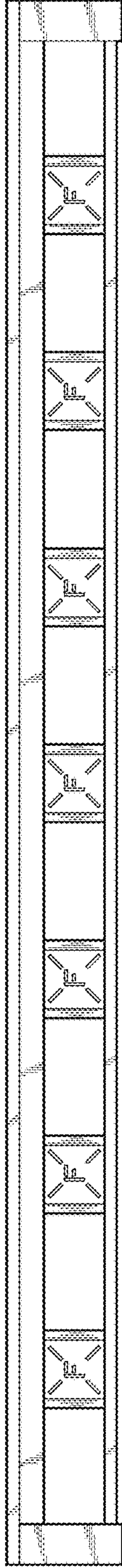

FIG. 3

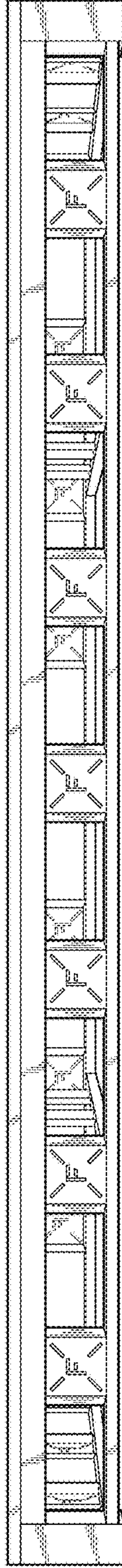
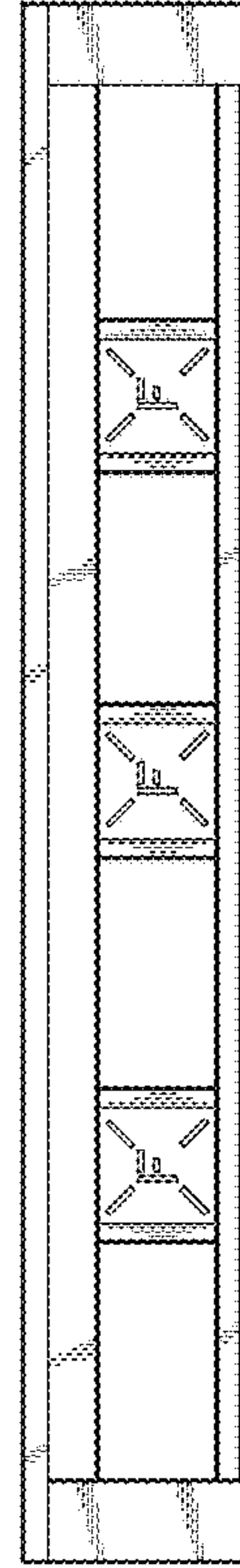

FIG. 4



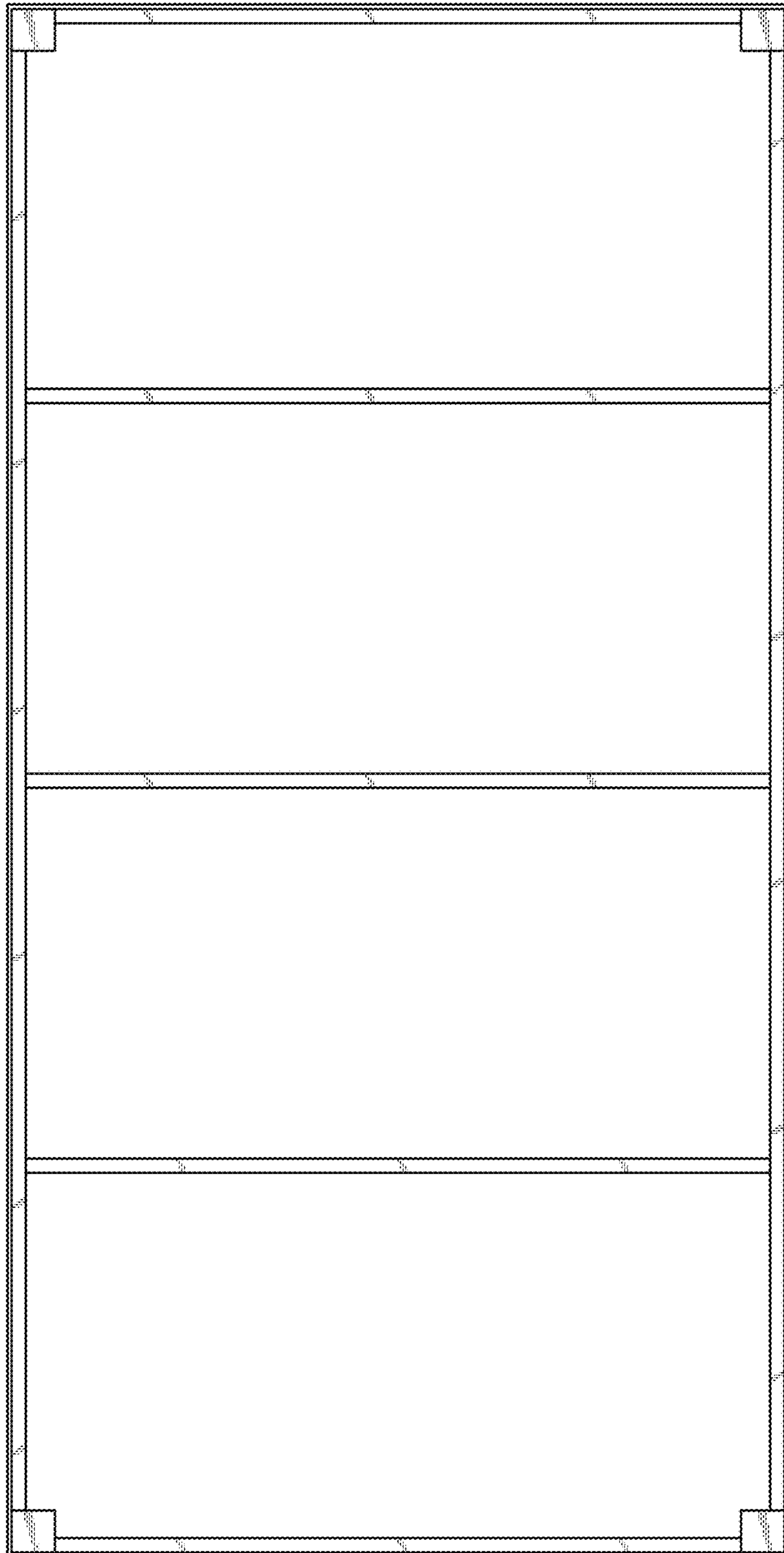

FIG. 5

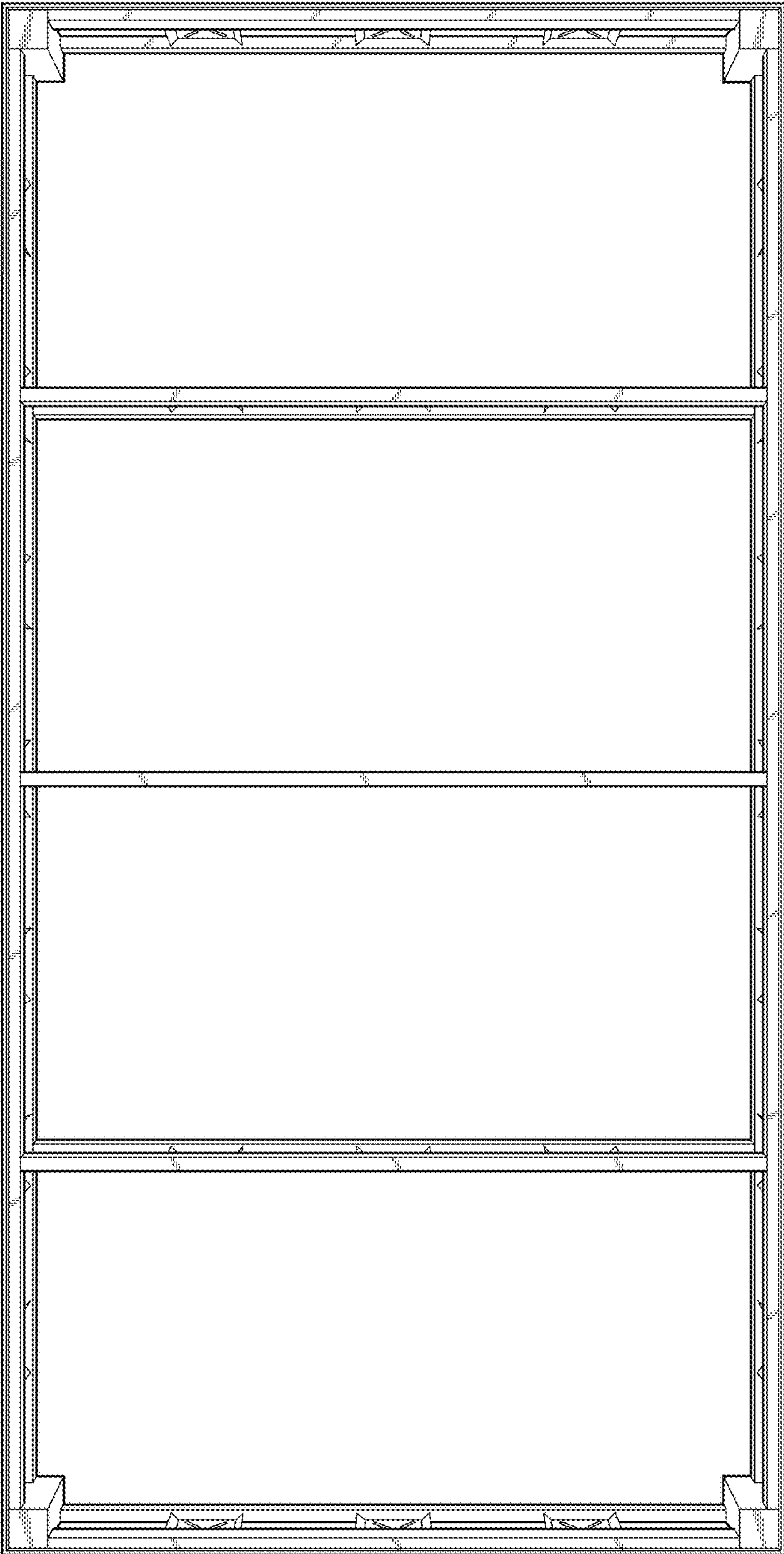

FIG. 6

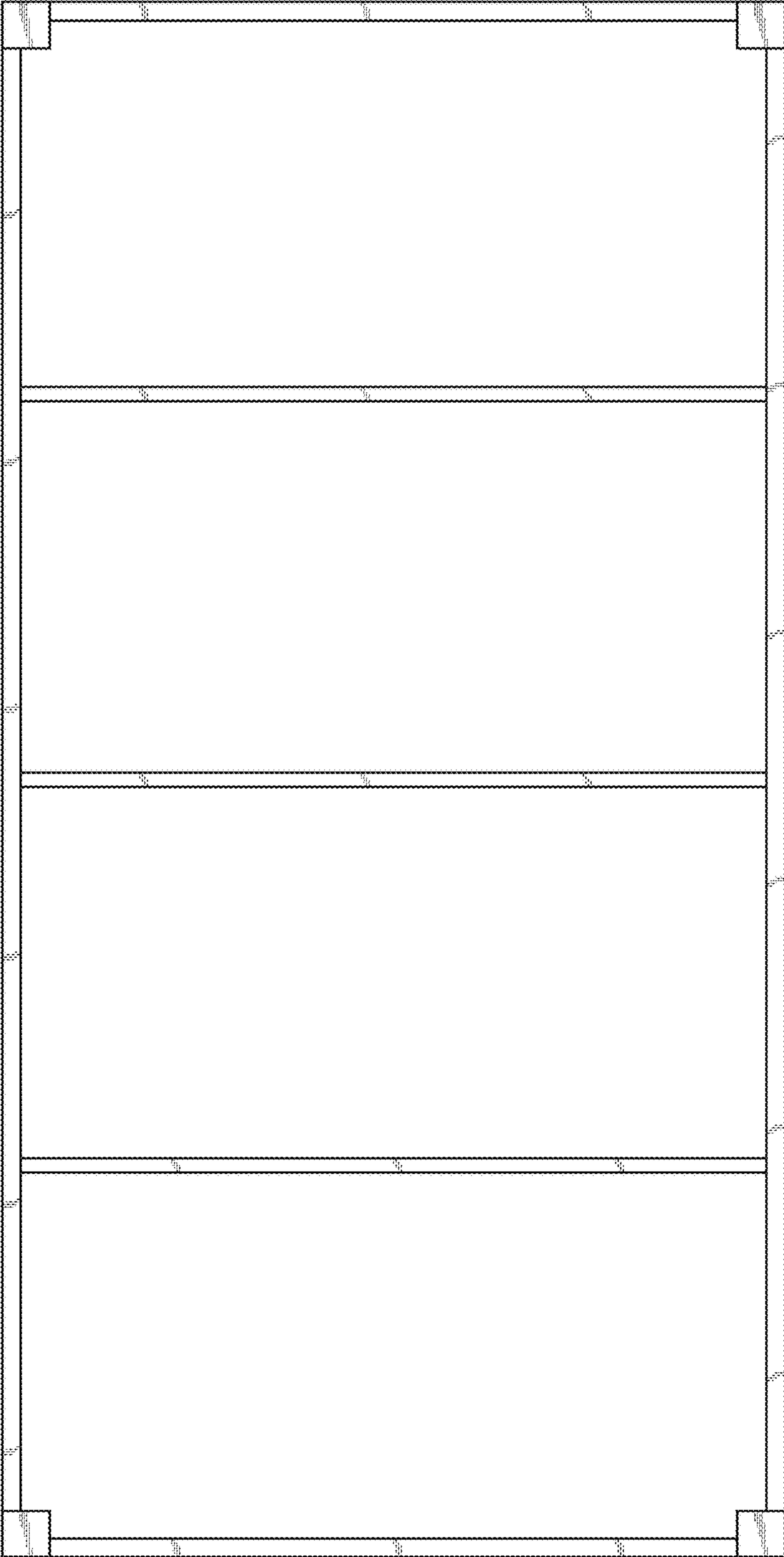

FIG. 7