



US00D781439S

(12) **United States Design Patent**
Gill et al.

(10) **Patent No.:** **US D781,439 S**
(45) **Date of Patent:** **** Mar. 14, 2017**

(54) **MODULAR BUILDING**

- (71) Applicants: **Peter E. Gill**, Tamuning, GU (US);
Peter E. Gill, III, Tamuning, GU (US)
- (72) Inventors: **Peter E. Gill**, Tamuning, GU (US);
Peter E. Gill, III, Tamuning, GU (US)
- (73) Assignee: **KWIKSPACE GUAM, INC.**, Hagatna,
Guam
- (**) Term: **15 Years**
- (21) Appl. No.: **29/547,925**
- (22) Filed: **Dec. 9, 2015**

Related U.S. Application Data

- (63) Continuation-in-part of application No. 14/221,335,
filed on Mar. 21, 2014, which is a continuation-in-part
of application No. 14/143,057, filed on Dec. 30, 2013,
now abandoned, which is a continuation-in-part of
application No. 13/870,141, filed on Apr. 25, 2013,
now Pat. No. 8,640,396.
- (51) **LOC (10) Cl.** **25-03**
- (52) **U.S. Cl.**
USPC **D25/1**
- (58) **Field of Classification Search**
USPC D25/1-35
CPC E04B 1/02; E04B 1/04; E04B 1/10; E04B
1/343; E04B 7/02; E04H 9/00; E04H
9/02; E04H 9/04; E04H 9/14; E04H 9/16;
E04H 7/00; E04H 7/02; E04H 6/00;
E04H 5/00; E04H 5/02; E04H 14/00;
E04H 13/00; E04H 12/00; E04H 12/18;
E04H 12/34
See application file for complete search history.

(56) **References Cited**

U.S. PATENT DOCUMENTS

3,095,616 A *	7/1963	Bigelow, Jr.	B60P 3/34 254/45
3,104,427 A *	9/1963	Bearde	E04B 1/02 52/250
3,137,041 A *	6/1964	Mullen	B60P 3/34 296/171
3,462,897 A *	8/1969	Weinrott	E04B 1/10 52/169.14
D216,954 S *	3/1970	Jenn	52/79.7
3,507,079 A *	4/1970	George	E04D 13/15 52/314
3,768,217 A *	10/1973	Tyson	E04D 13/15 52/543
4,122,639 A *	10/1978	Barrell	E04B 7/02 52/92.1

(Continued)

Primary Examiner — Manpreet Matharu
Assistant Examiner — Suzanne Tisdell
(74) *Attorney, Agent, or Firm* — Donald J. Ersler

(57) **CLAIM**

The ornamental design for a modular building, as shown and described.

DESCRIPTION

FIG. 1 is a top perspective view of a modular building incorporating our new design;
FIG. 2 is a bottom perspective view of a modular building;
FIG. 3 is a front view of a modular building;
FIG. 4 is a left side or right side view of a modular building;
FIG. 5 is a top plan view of a modular building; and,
FIG. 6 is a bottom plan view of a modular building.
The broken lines shown in the drawings illustrate portions of the modular building that forms no part of the claimed invention.

1 Claim, 6 Drawing Sheets

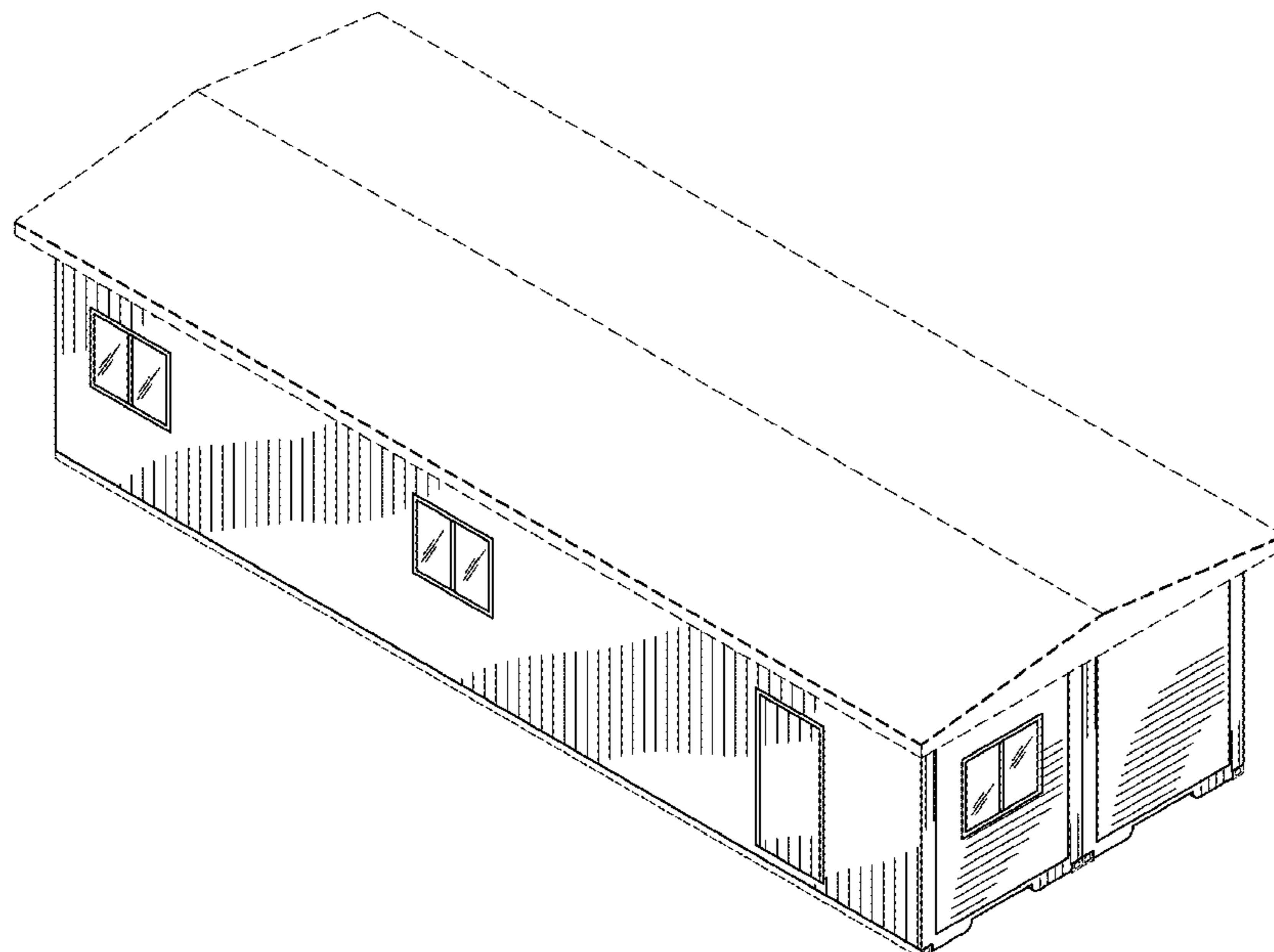

(56)

References Cited

U.S. PATENT DOCUMENTS

4,435,926	A *	3/1984	Struben	E04B 7/02 52/22
D285,971	S *	9/1986	Marty	D25/17
D293,925	S *	1/1988	Roy	D21/511
5,706,614	A	1/1998	Wiley, Jr. et al.	
D390,970	S *	2/1998	Abrams	D25/1
5,983,572	A *	11/1999	Laboy	E04B 7/02 52/167.1
6,578,331	B1 *	6/2003	Leslie	E04B 1/10 52/262
7,086,209	B1 *	8/2006	Pruitt	E04B 1/34336 52/125.1
D625,835	S *	10/2010	McKimmy	D25/33
8,001,730	B2	8/2011	Wallance	
D683,047	S *	5/2013	Gill	D25/22
D727,531	S *	4/2015	Gill	D25/22
D771,272	S *	11/2016	Hart	D25/1
D771,274	S *	11/2016	Breen	D25/22
D771,835	S *	11/2016	Bottin	D25/33
2002/0174606	A1 *	11/2002	Hunt	E04B 1/04 52/79.1
2005/0284064	A1 *	12/2005	Price	E04B 1/10 52/404.1
2013/0061553	A1 *	3/2013	Nagy	E04B 1/04 52/741.3

* cited by examiner

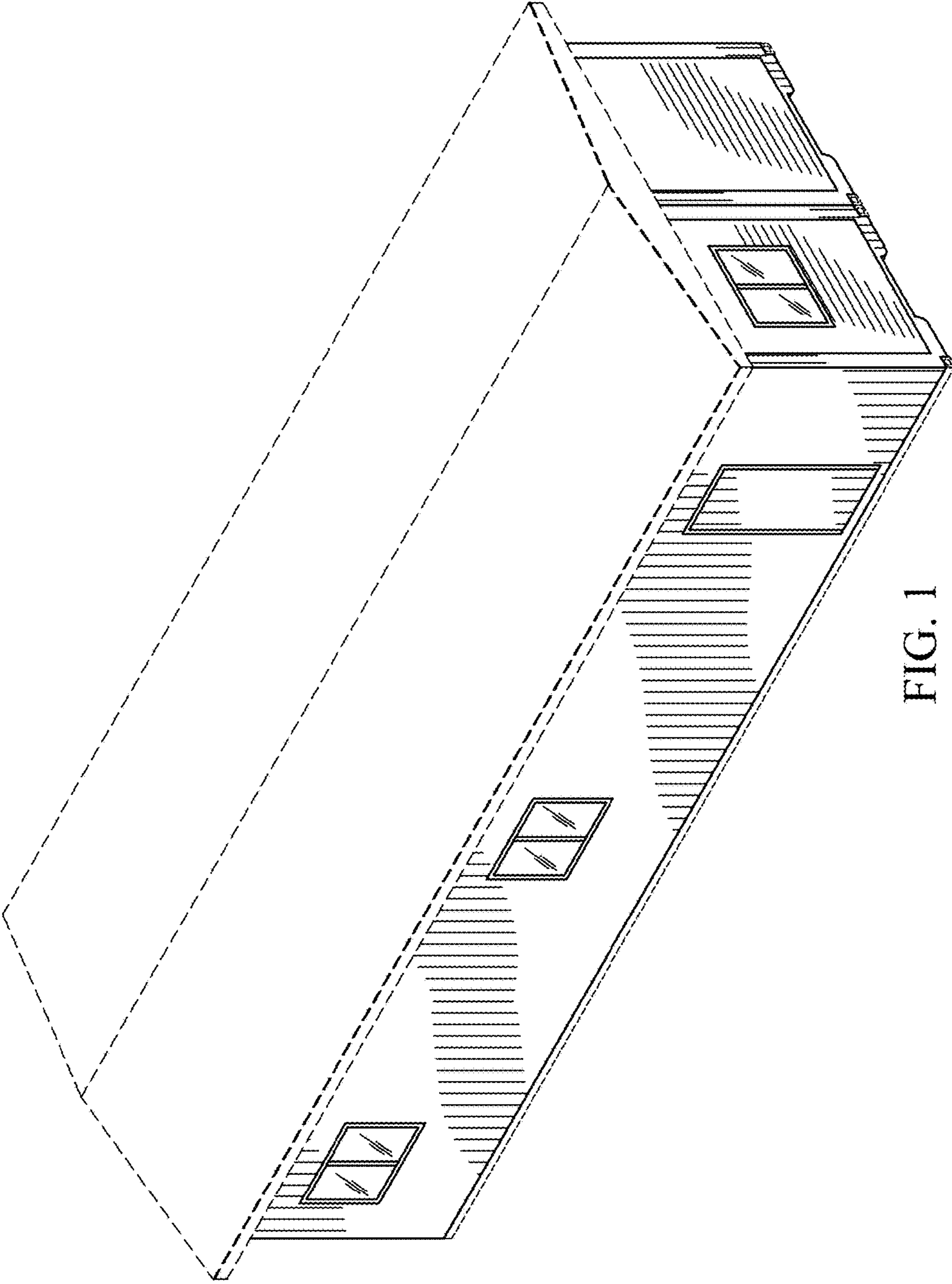

FIG. 1

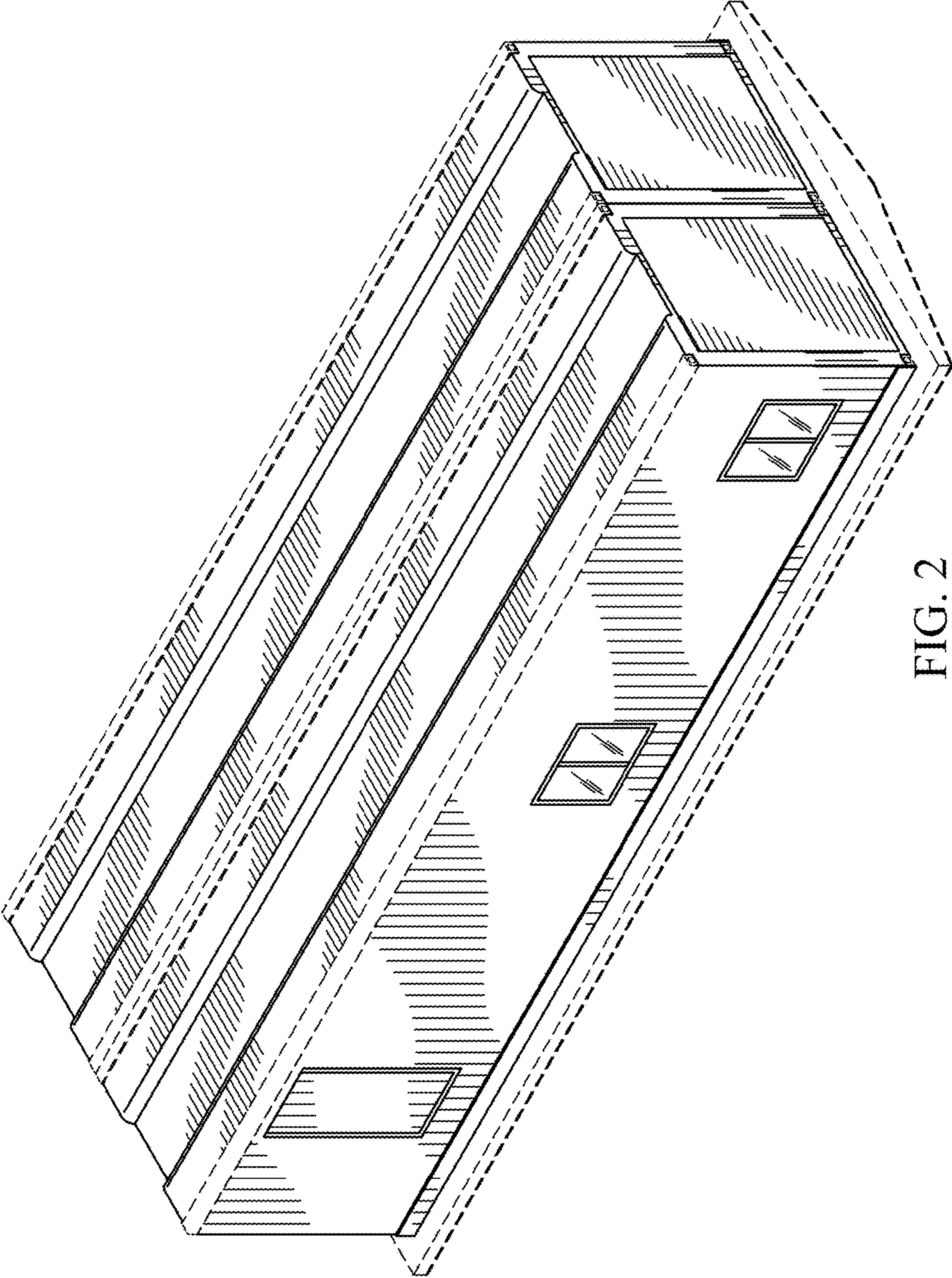

FIG. 2

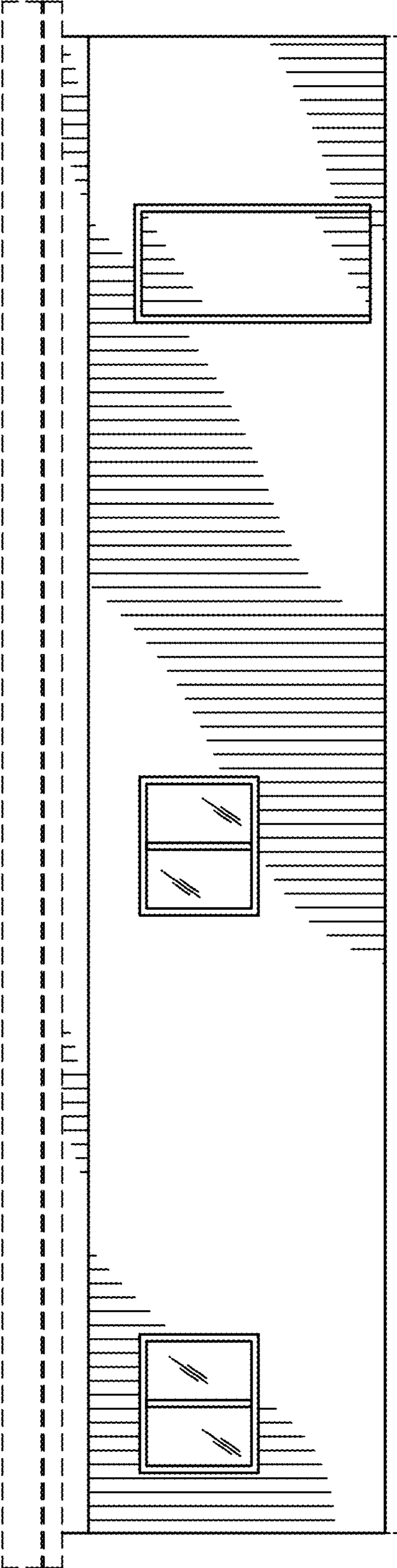

FIG. 3

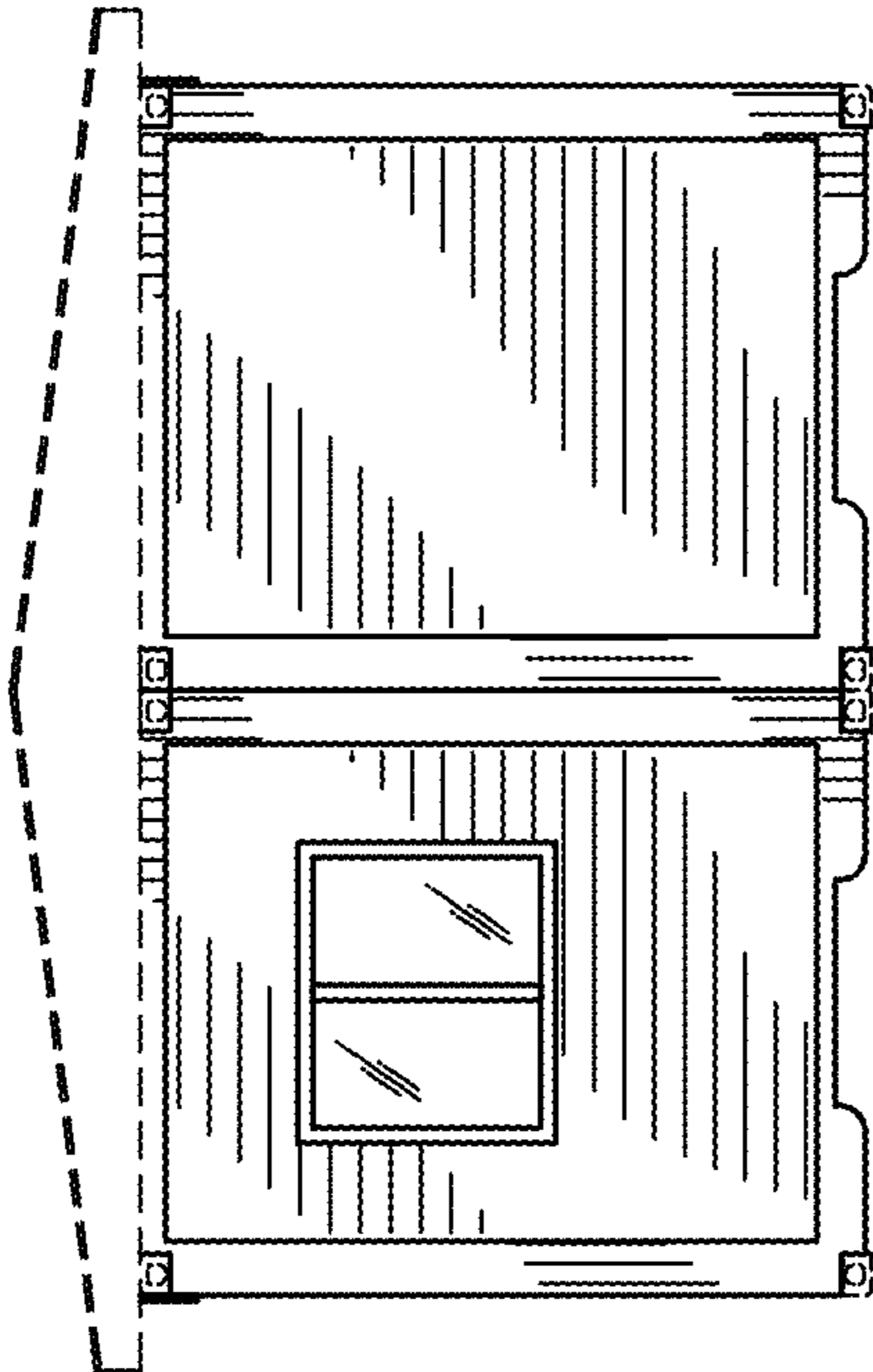

FIG. 4

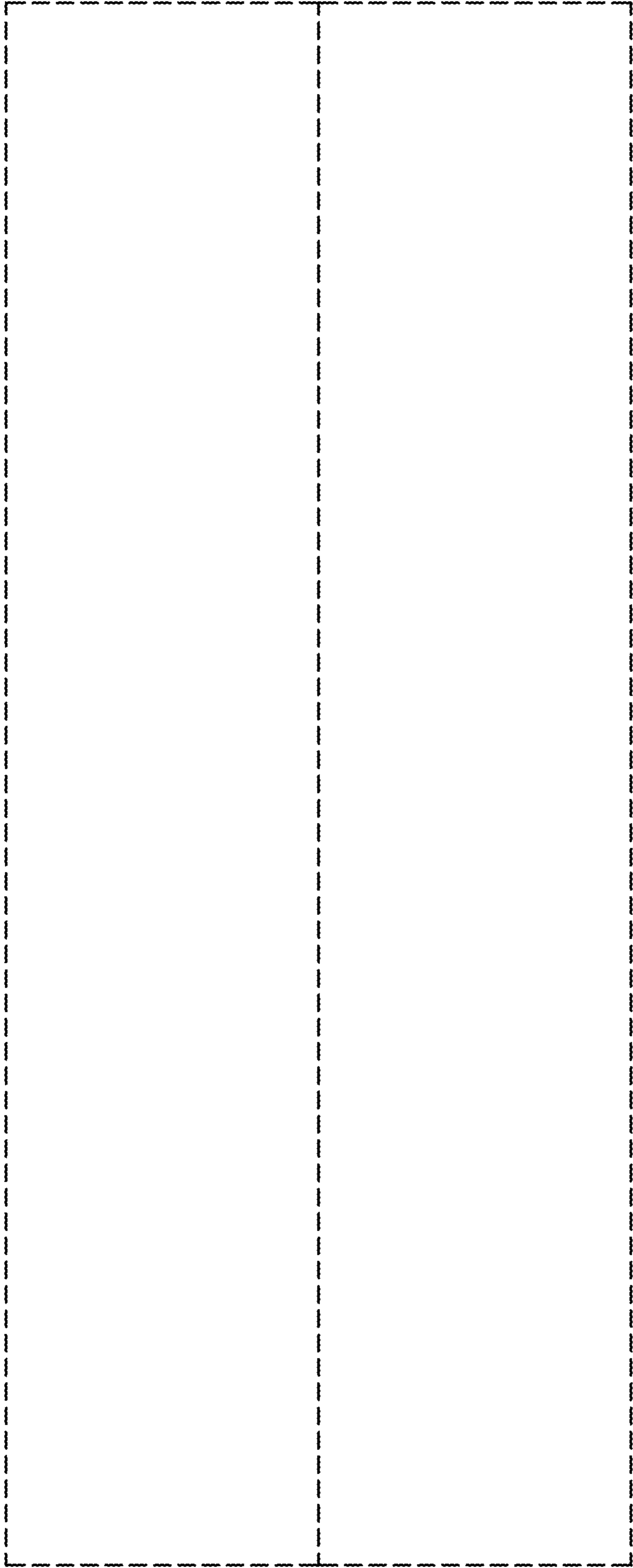

FIG. 5

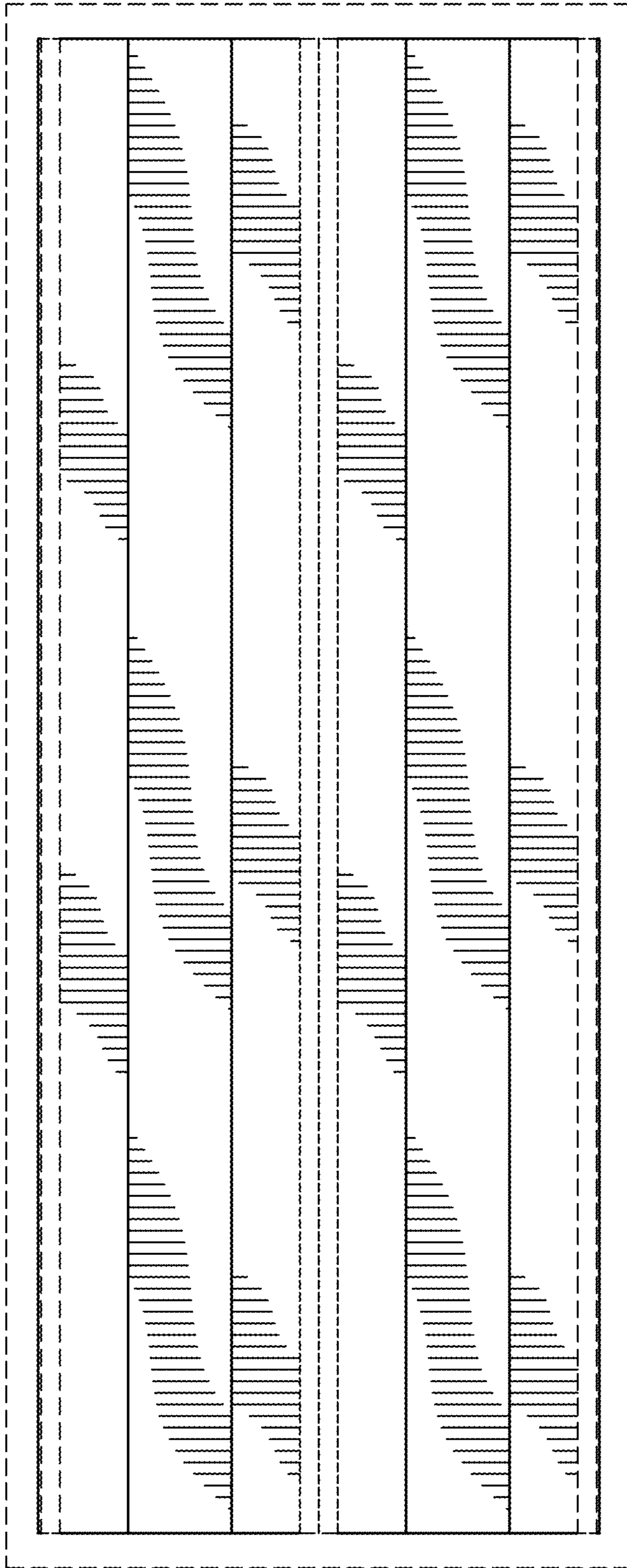

FIG. 6