



US00D781438S

(12) **United States Design Patent**  
**Dressler et al.**

(10) **Patent No.:** **US D781,438 S**  
(45) **Date of Patent:** **\*\* Mar. 14, 2017**

- (54) **DOCKING STATION AND TRAY**
- (71) Applicant: **Alpha Plan GmbH**, Radeberg (DE)
- (72) Inventors: **Sebastian Dressler**, Dresden (DE);  
**Simone Valley**, Arnsdorf (DE)
- (73) Assignee: **Alpha Plan GmbH**, Radeberg (DE)
- (\*\*) Term: **14 Years**
- (21) Appl. No.: **29/506,999**
- (22) Filed: **Oct. 23, 2014**
- (51) **LOC (10) Cl.** ..... **24-02**
- (52) **U.S. Cl.**  
USPC ..... **D24/232; D24/227**
- (58) **Field of Classification Search**  
USPC ..... D24/227-232; D28/61; D19/75, 83, 85,  
D19/92; D14/434; D7/601, 632, 409;  
(Continued)

- (56) **References Cited**  
U.S. PATENT DOCUMENTS  
D176,366 S \* 12/1955 McFadyen ..... D19/83  
3,467,247 A \* 9/1969 Weiss ..... B65D 1/36  
206/561  
(Continued)

*Primary Examiner* — Wan Laymon  
(74) *Attorney, Agent, or Firm* — Michael Soderman

(57) **CLAIM**  
The ornamental design for a docking station and tray, as shown and described.

**DESCRIPTION**

FIG. 1 is an assembled perspective view of the docking station and tray showing the new design;

FIG. 2 is an enlarged top view thereof;  
 FIG. 3 is a bottom view thereof;  
 FIG. 4 is a right side view thereof;  
 FIG. 5 is a left side view thereof;  
 FIG. 6 is a front view thereof;  
 FIG. 7 is a rear view thereof;  
 FIG. 8 is a perspective view of the docking station with the tray removed for ease of illustration;  
 FIG. 9 is a bottom view thereof;  
 FIG. 10 is a front view thereof;  
 FIG. 11 is a top view thereof;  
 FIG. 12 is a right side view thereof;  
 FIG. 13 is a left side view thereof;  
 FIG. 14 is a rear view thereof;  
 FIG. 15 is a perspective view of the tray with the docking station removed for ease of illustration;  
 FIG. 16 is a top view thereof;  
 FIG. 17 is a front view thereof;  
 FIG. 18 is a side view thereof;  
 FIG. 19 is a rear view thereof;  
 FIG. 20 is a bottom view thereof;  
 FIG. 21 is a perspective view of the tub with the docking station and tray removed for ease of illustration;  
 FIG. 22 is a top view thereof;  
 FIG. 23 is a right side view thereof;  
 FIG. 24 is a left side view thereof;  
 FIG. 25 is a front view thereof;  
 FIG. 26 is a bottom view thereof;  
 FIG. 27 is a perspective view of the tray with the docking station removed for ease of illustration;  
 FIG. 28 is a top view thereof;  
 FIG. 29 is a front view thereof;  
 FIG. 30 is a side view thereof; and,  
 FIG. 31 is a bottom view thereof.  
 The broken lines shown in the figures are included for the purpose of illustrating portions of the docking station and tray and form no part of the claimed design.

**1 Claim, 31 Drawing Sheets**

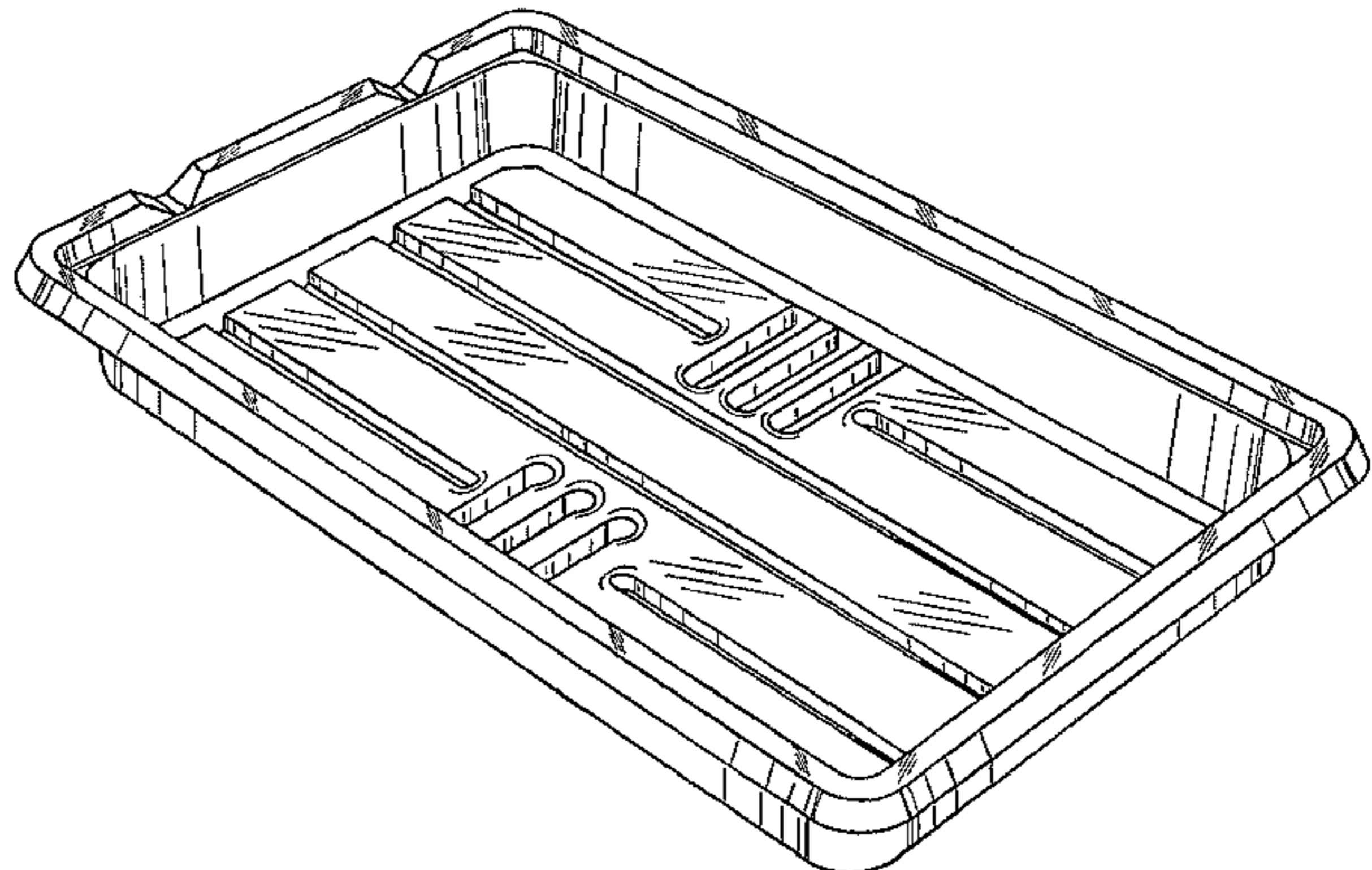
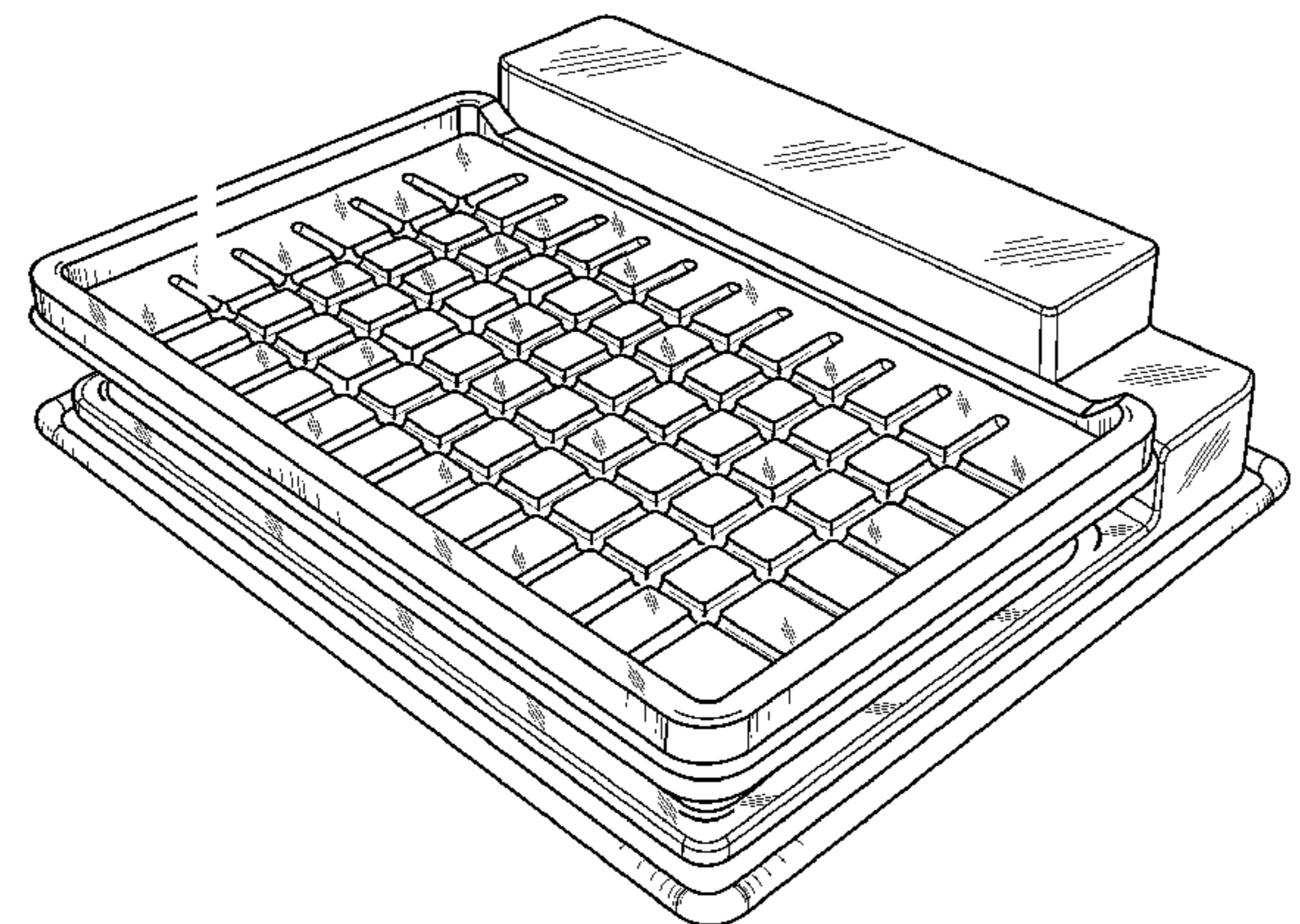

(58) **Field of Classification Search**

USPC ..... D3/304, 309; 206/518, 555, 557-558,  
206/564, 562, 563; 220/23.87, 532;  
422/500, 551, 565  
CPC .... B65D 1/34; B65D 1/36; B01L 9/00; B01L  
9/04

See application file for complete search history.

(56) **References Cited**

U.S. PATENT DOCUMENTS

D317,467 S *	6/1991	Kheng .....	D19/75
D454,202 S *	3/2002	Pham .....	D24/230
D646,797 S *	10/2011	Oonuma .....	D24/232
D694,906 S *	12/2013	Priebe .....	D24/229
D712,065 S *	8/2014	Noda .....	D24/232
D729,404 S *	5/2015	Teich .....	D24/230

\* cited by examiner

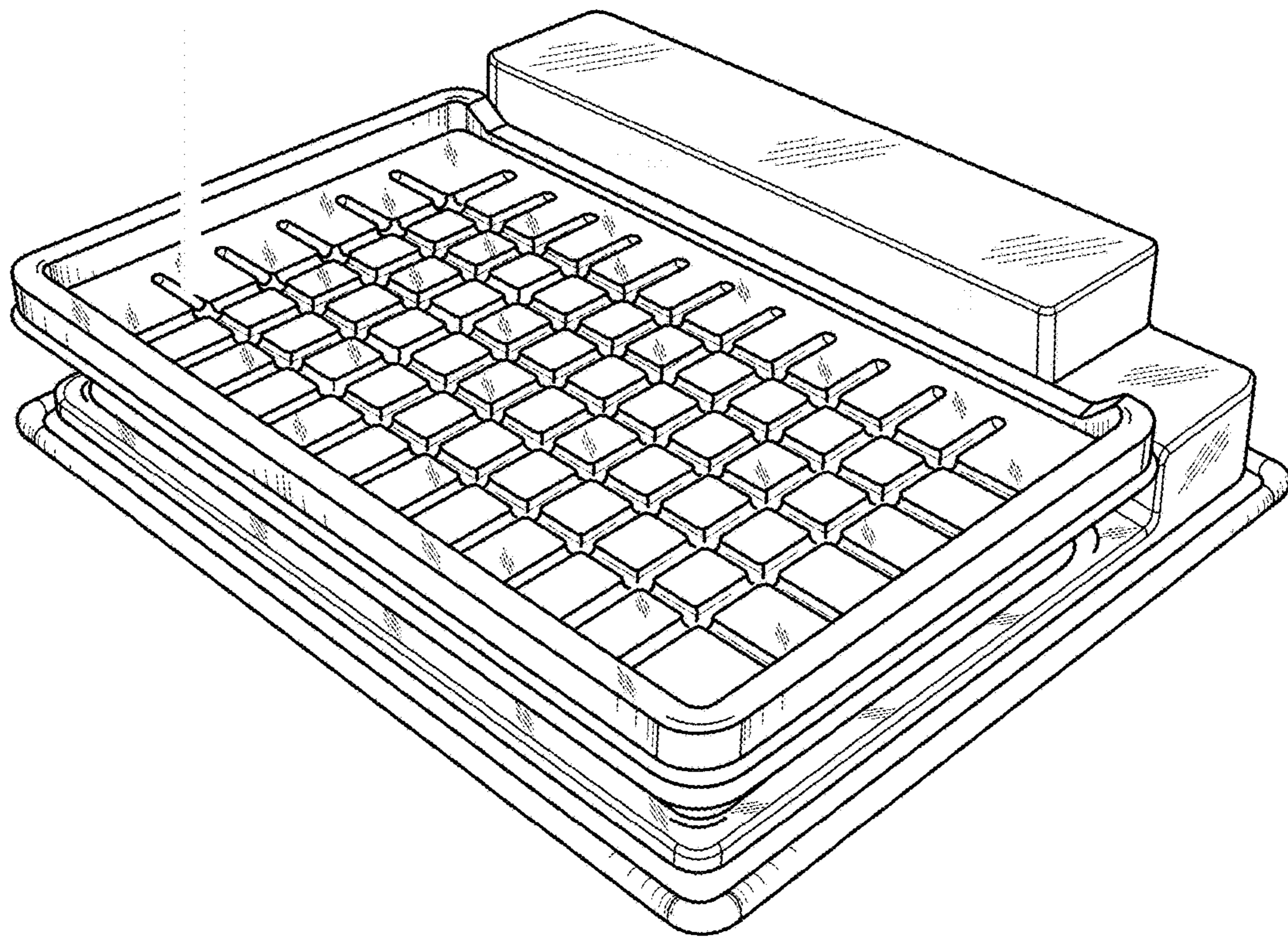

Fig. 1

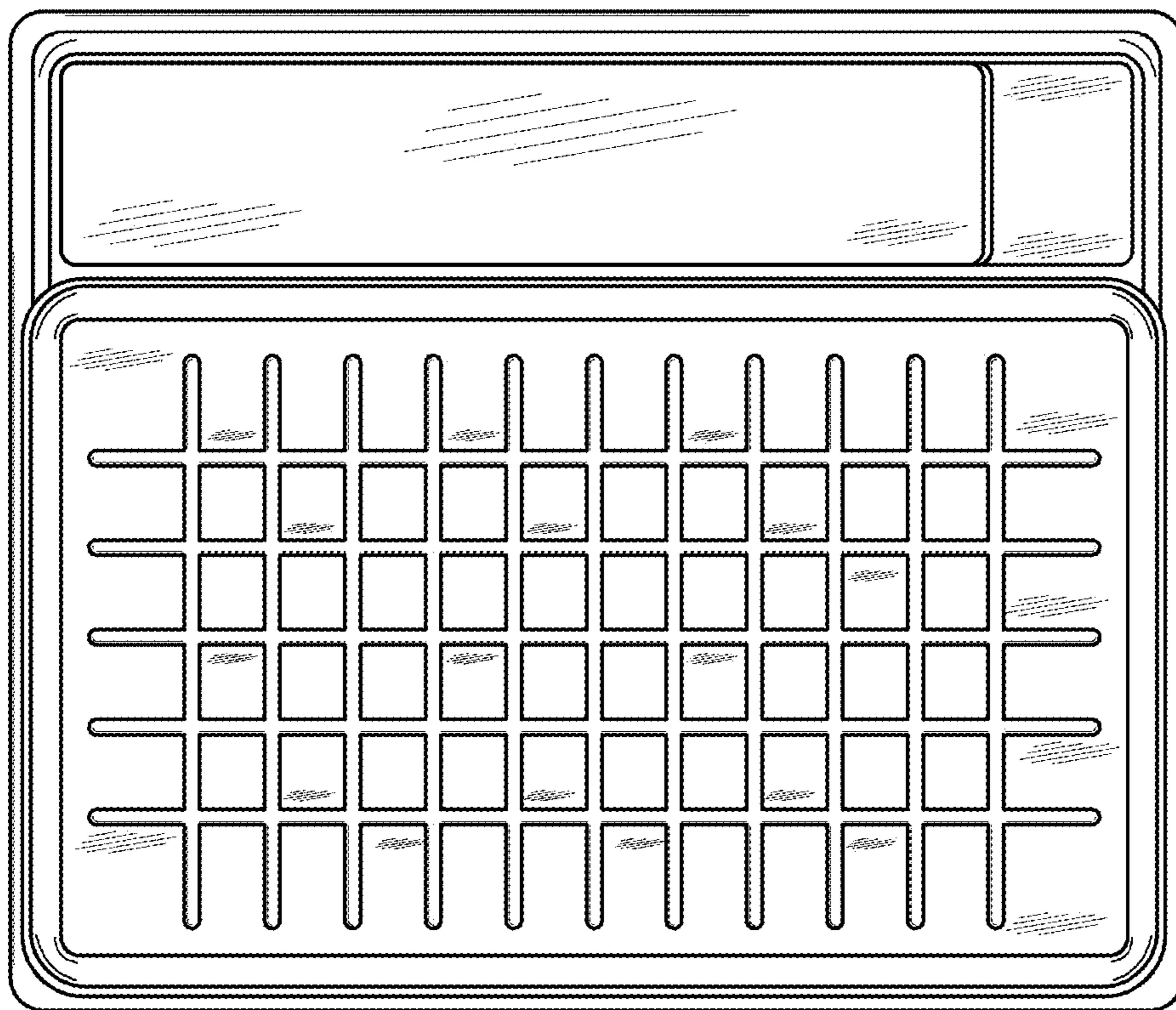

Fig. 2

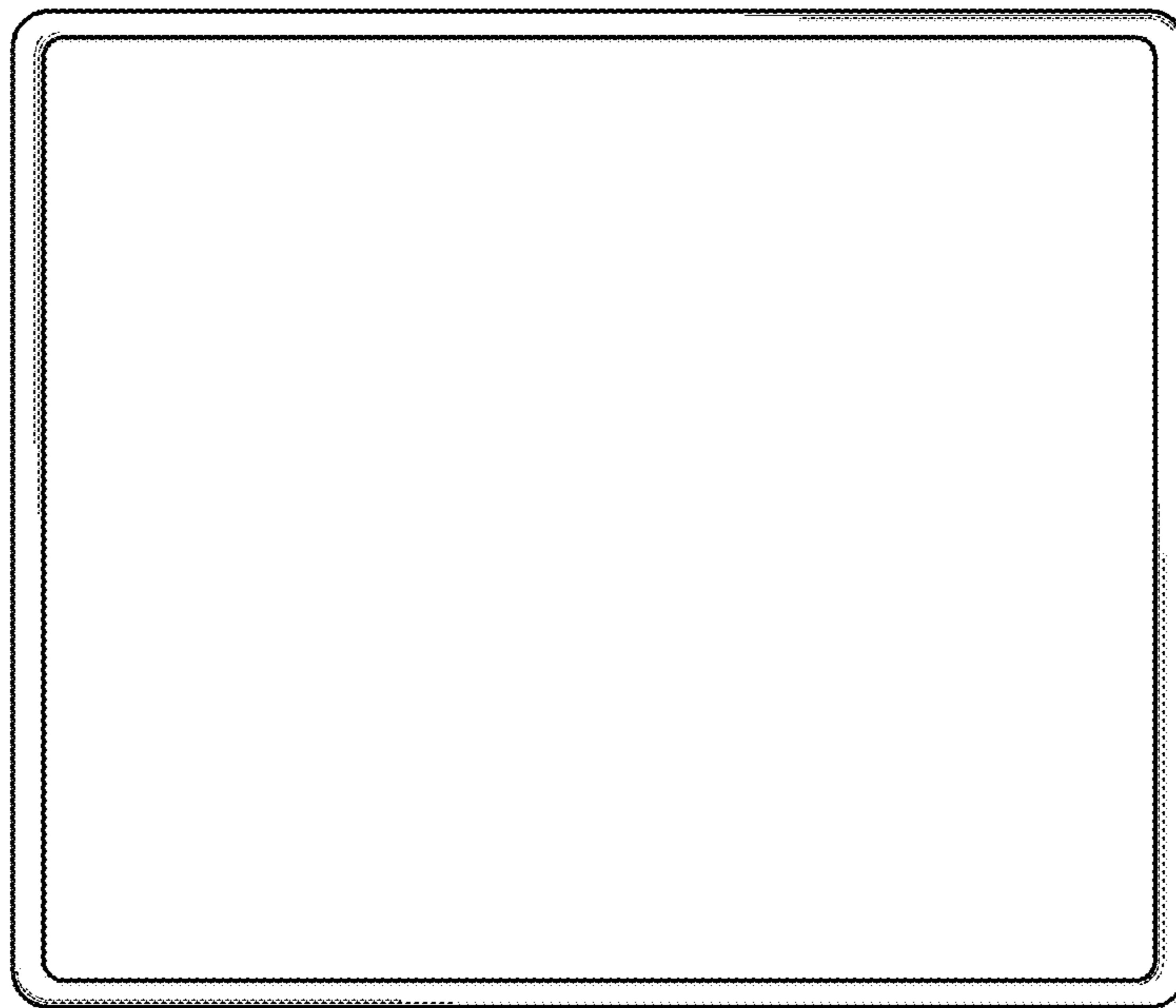

Fig. 3

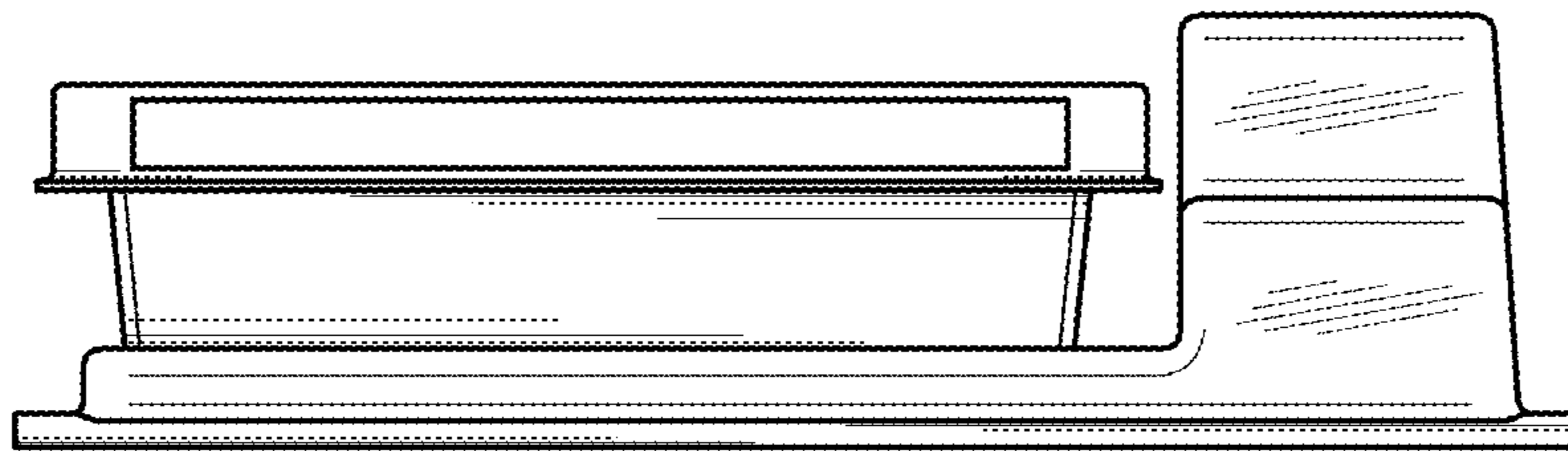

Fig. 4

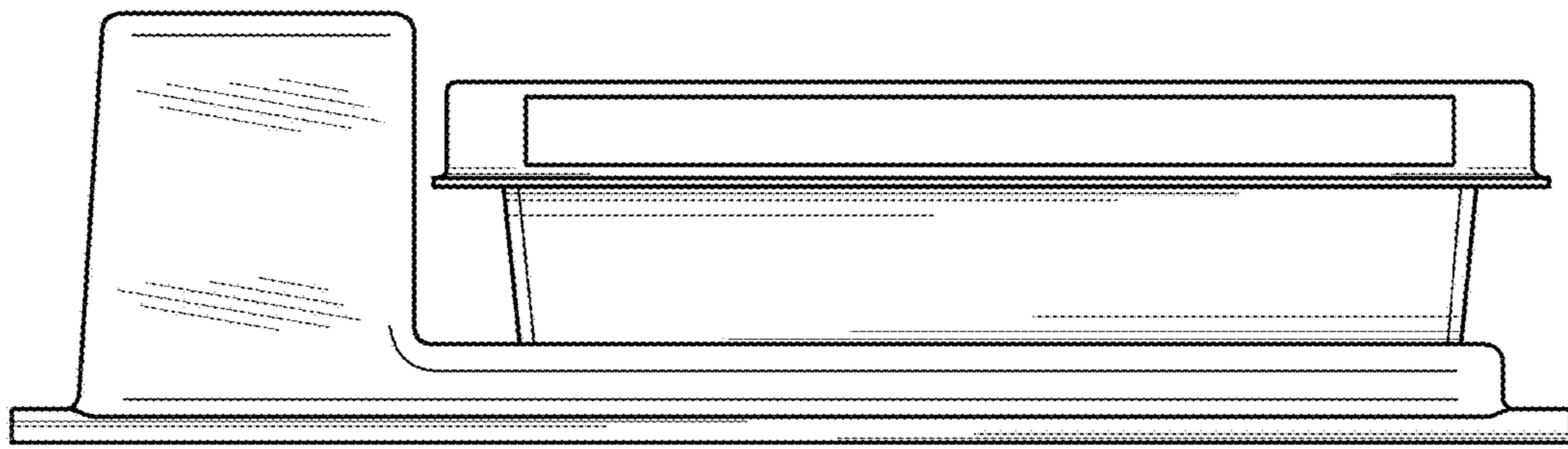

Fig. 5



Fig. 6



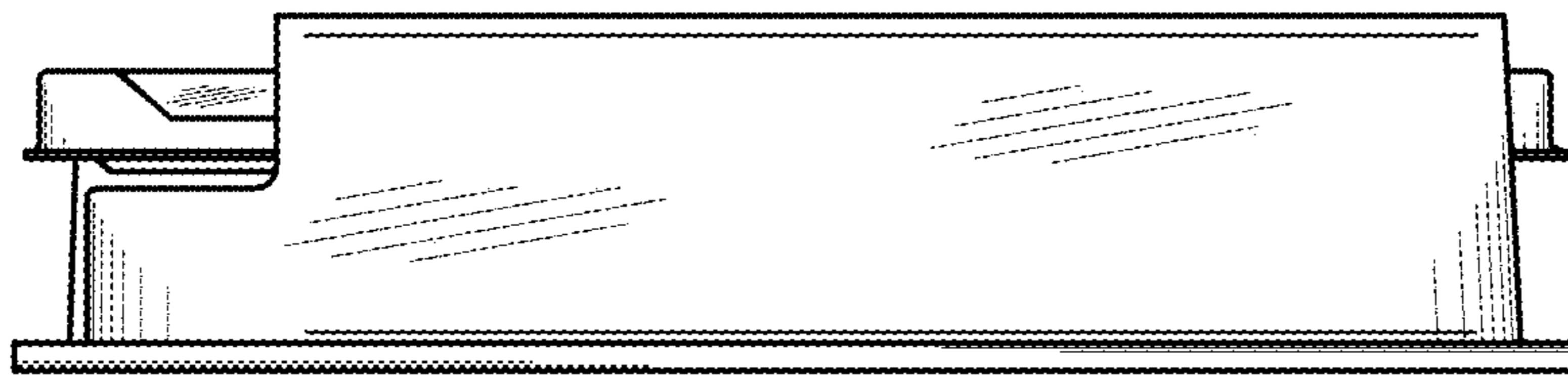

Fig. 7

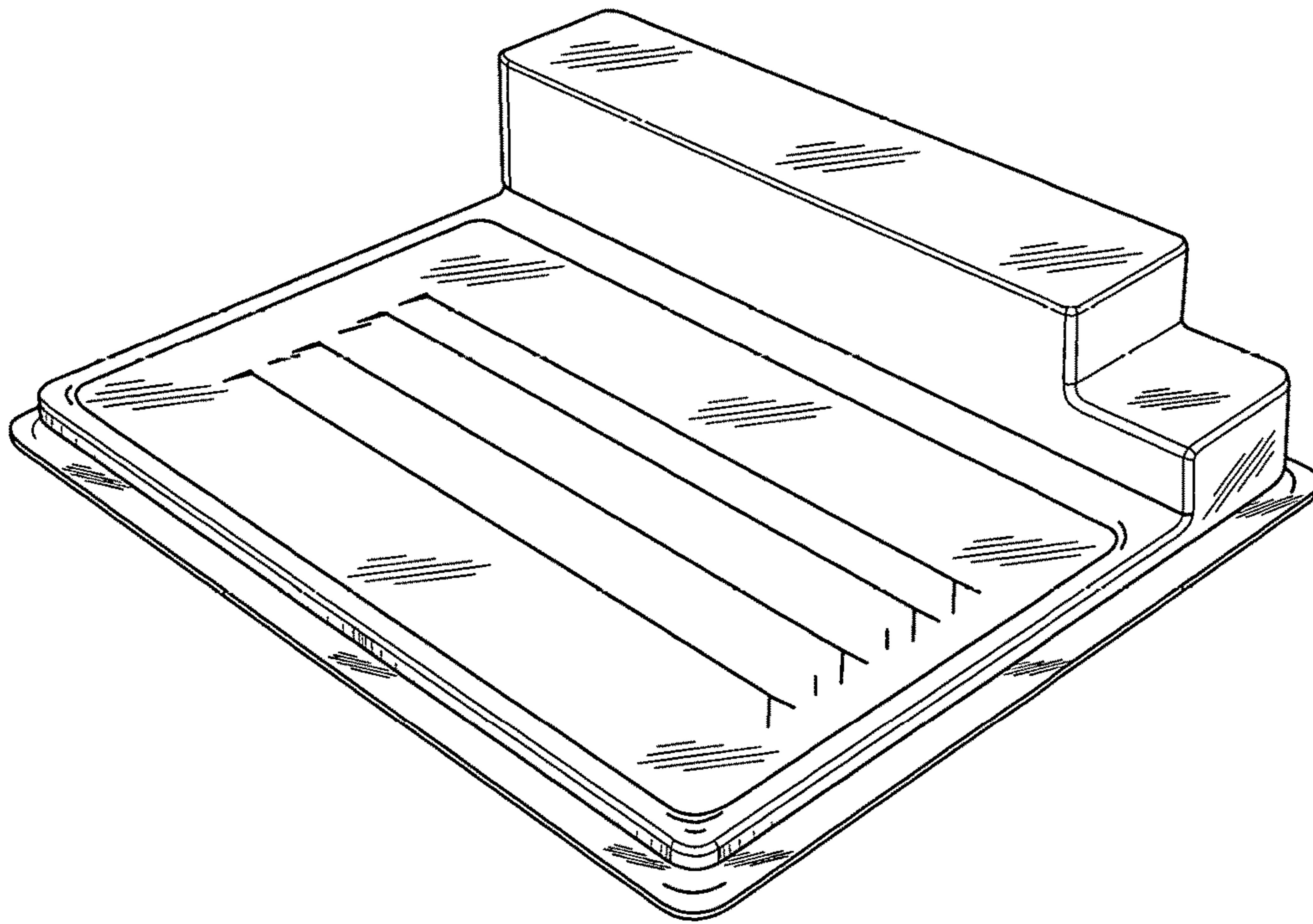

Fig. 8

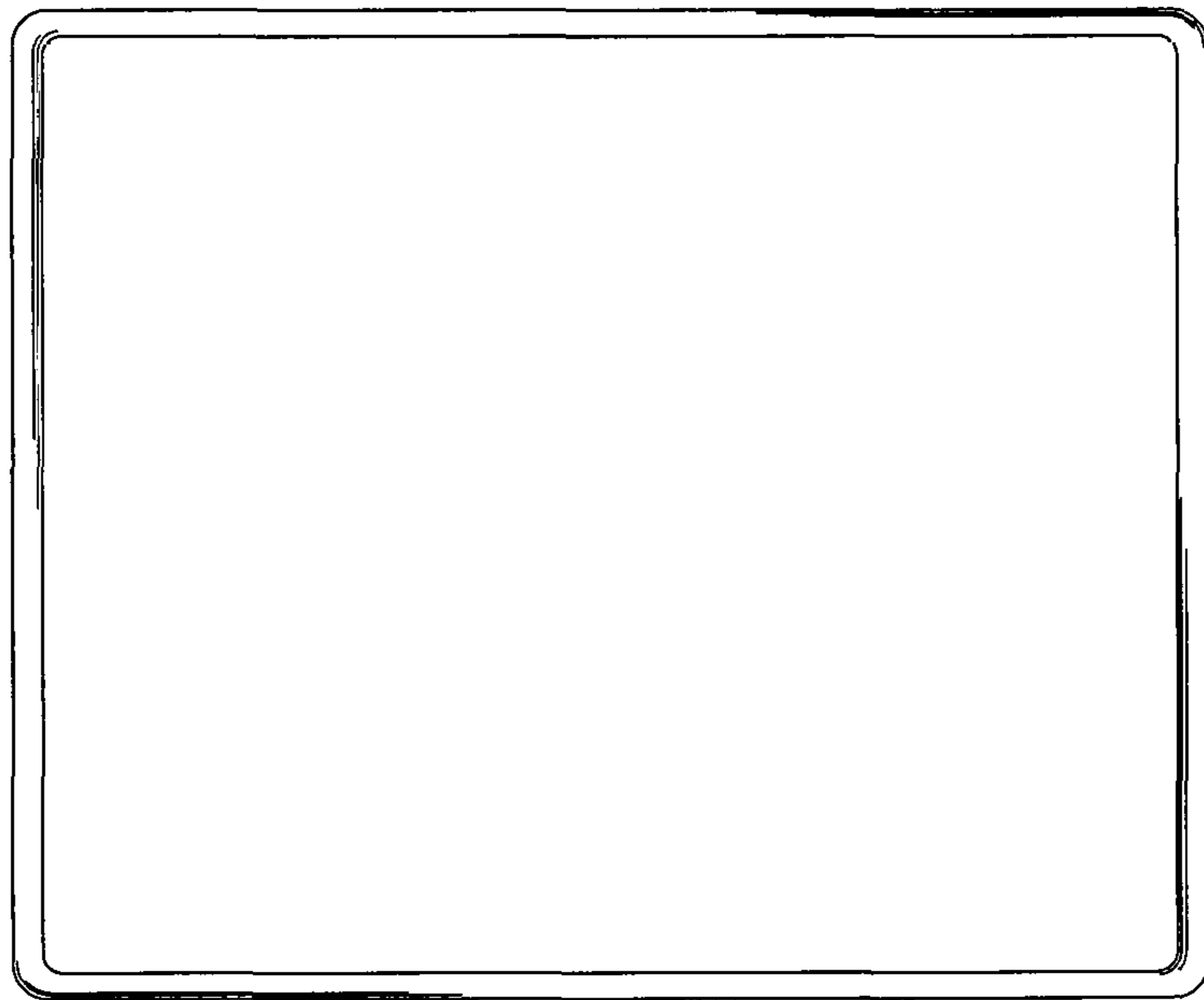

Fig. 9

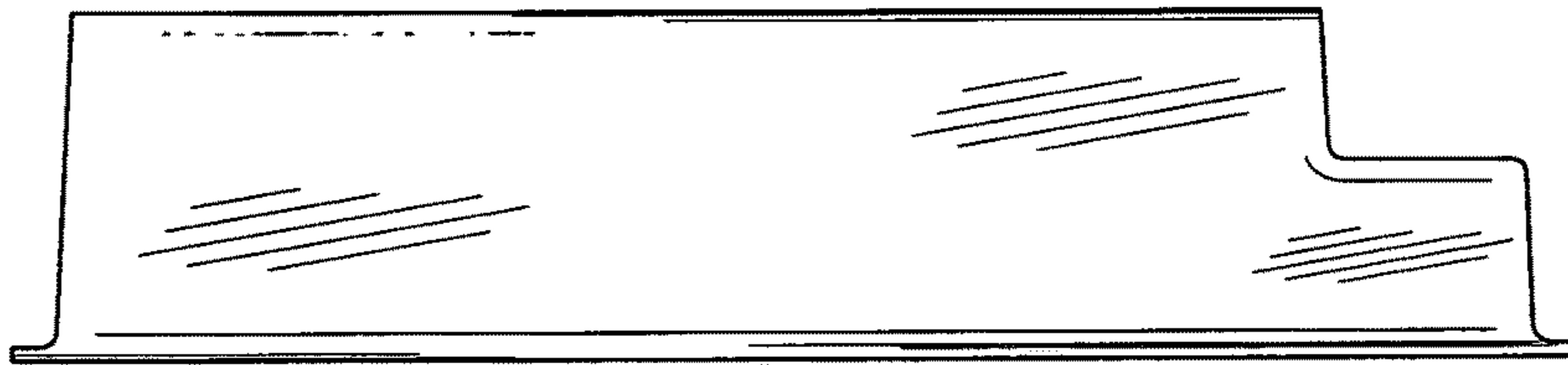

Fig. 10

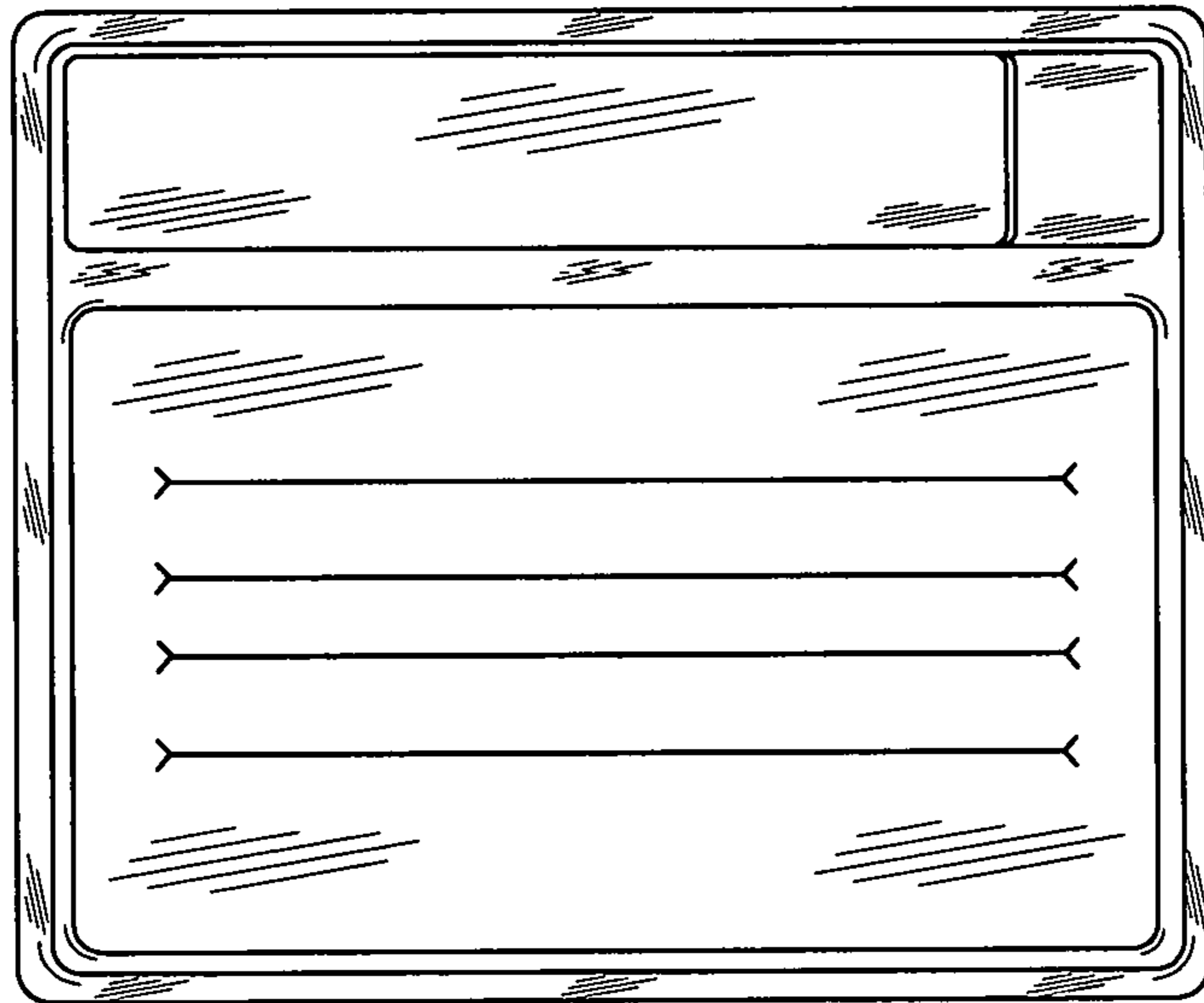

Fig. 11

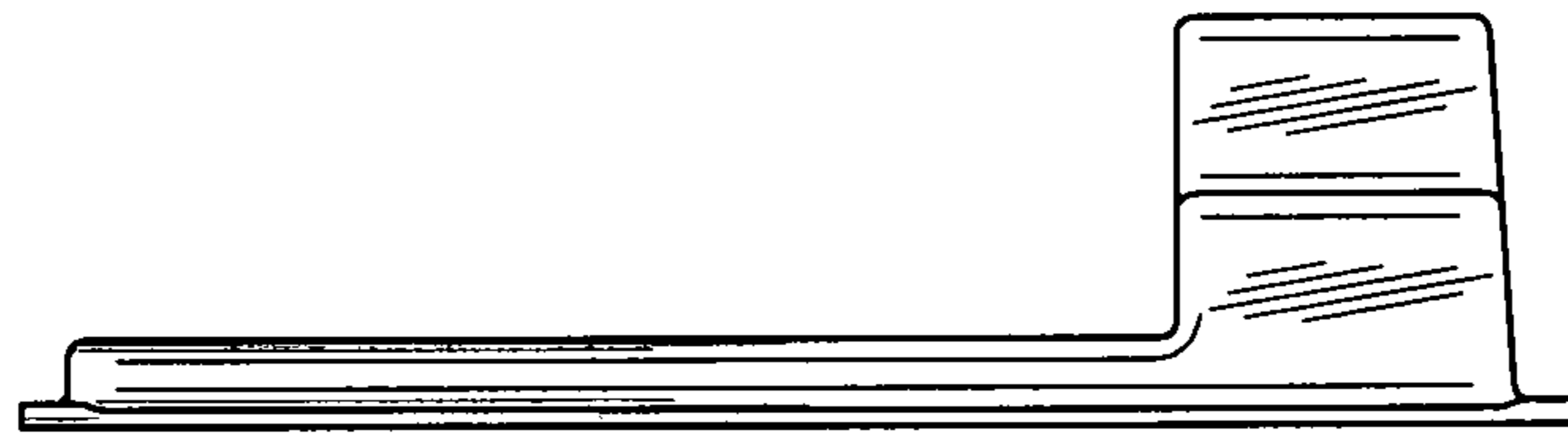

Fig. 12

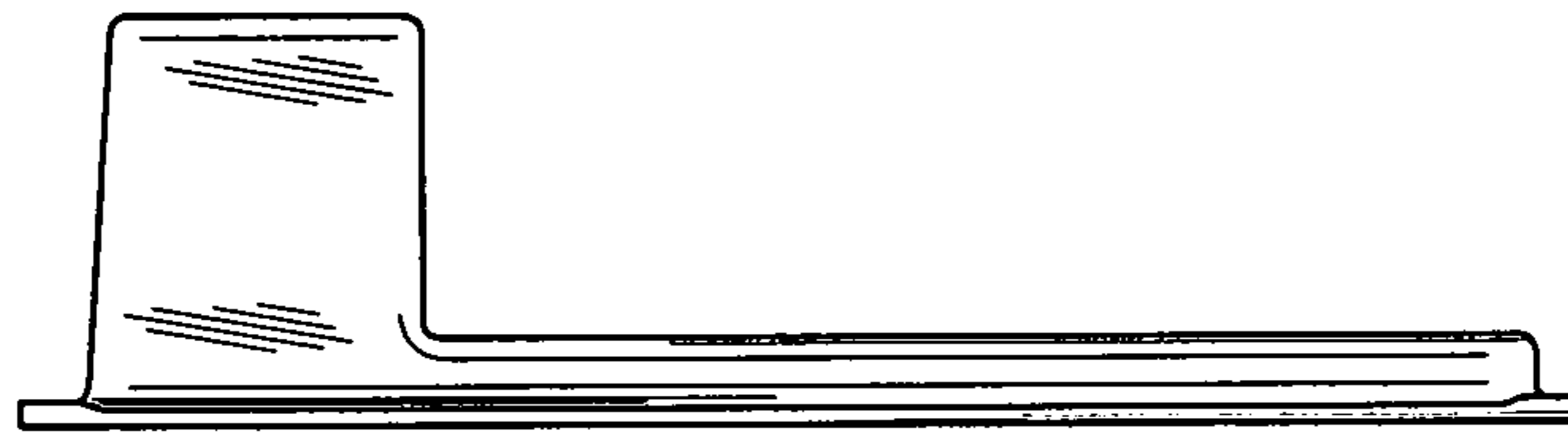

Fig. 13

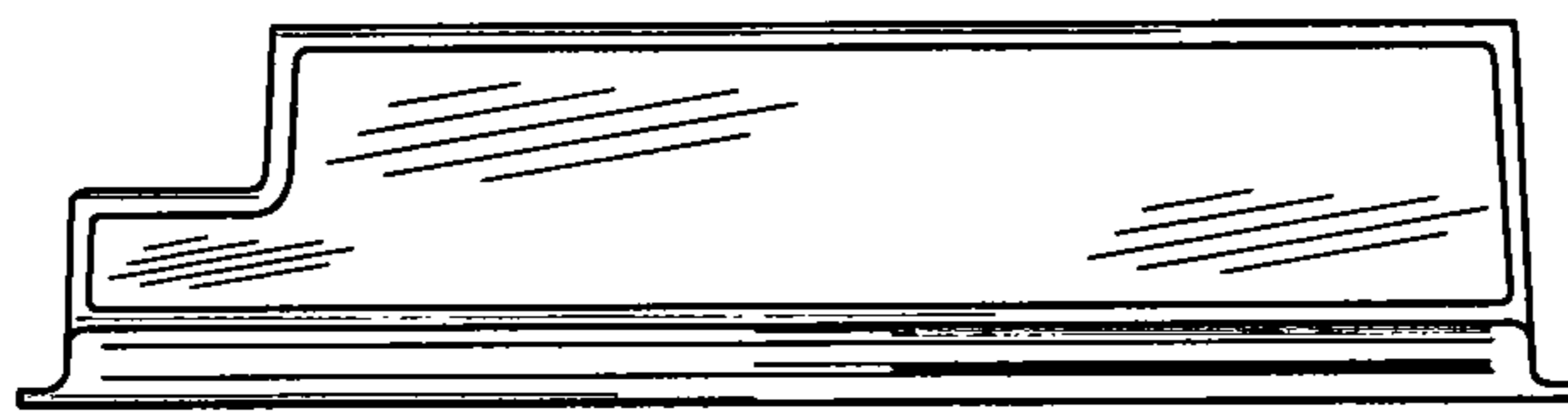

Fig. 14



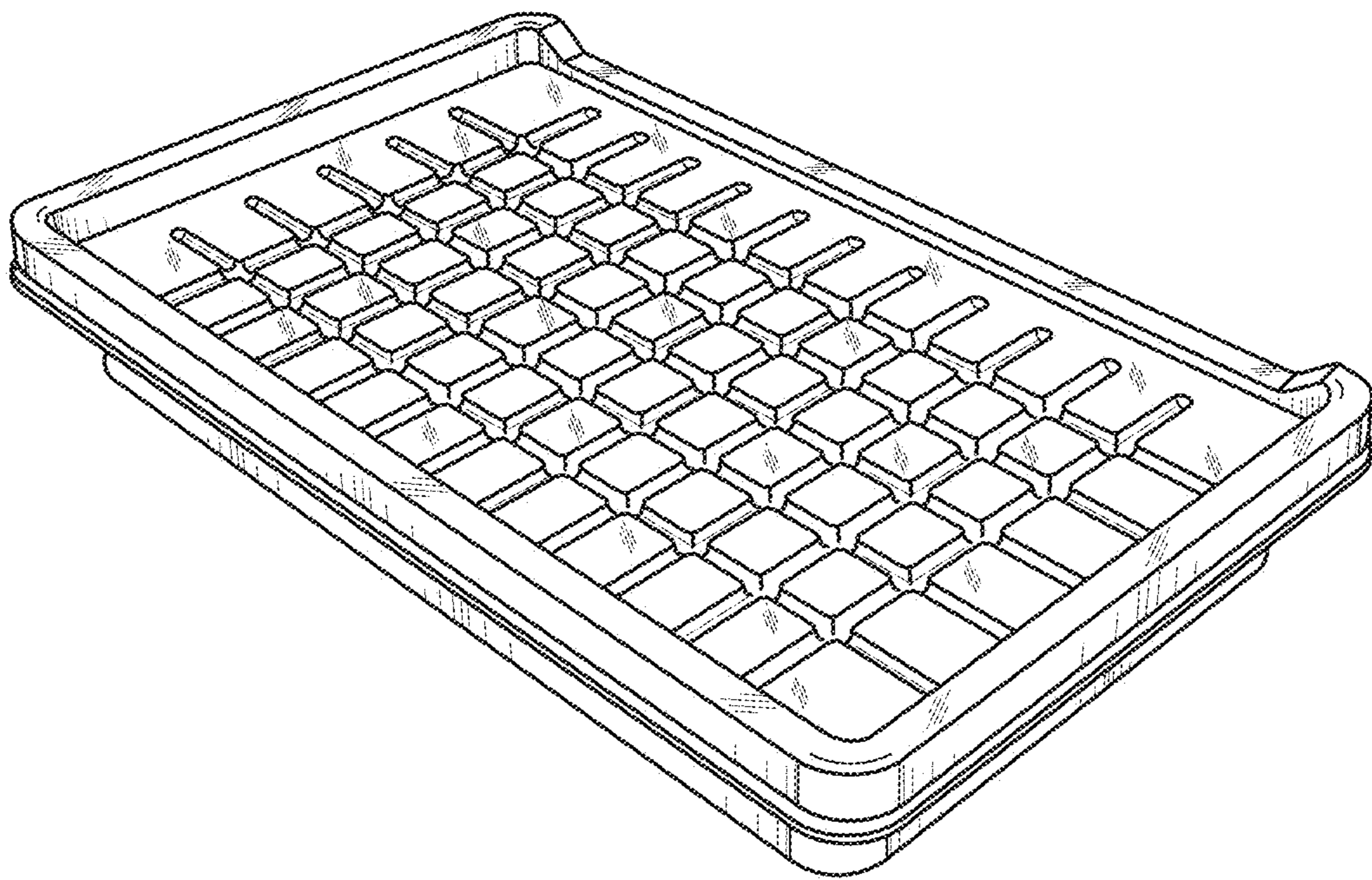

Fig. 15

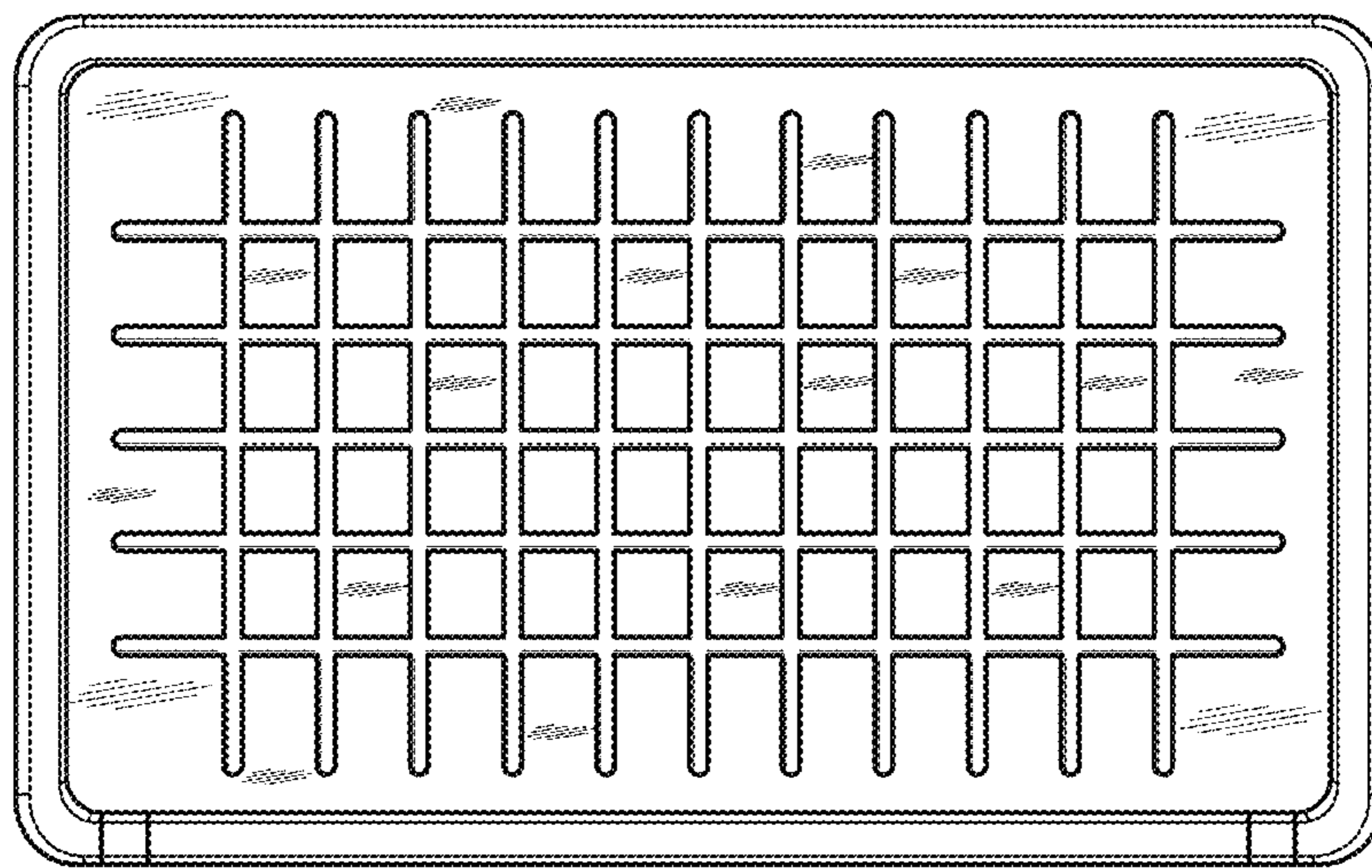

Fig. 16

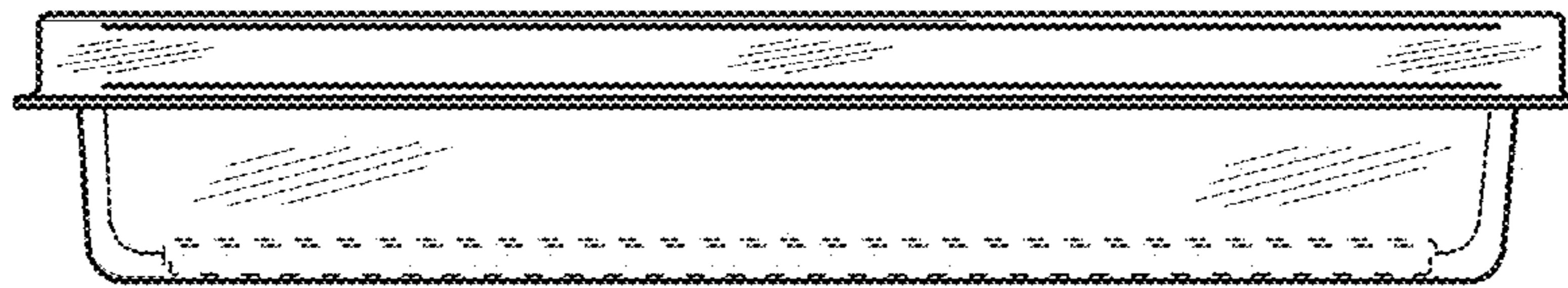

Fig. 17

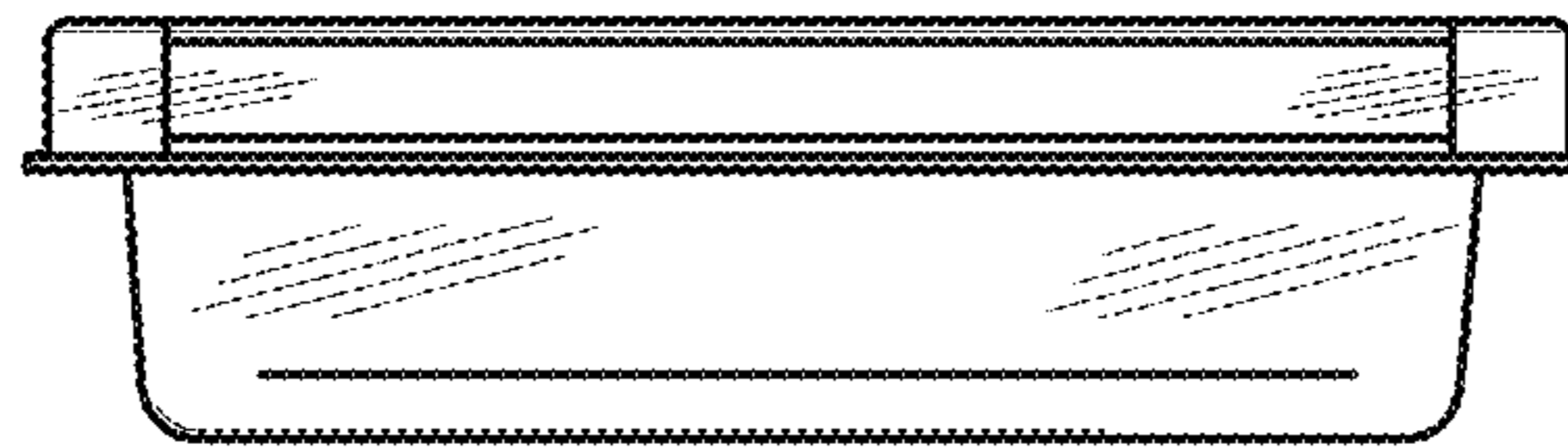

Fig. 18



Fig. 19

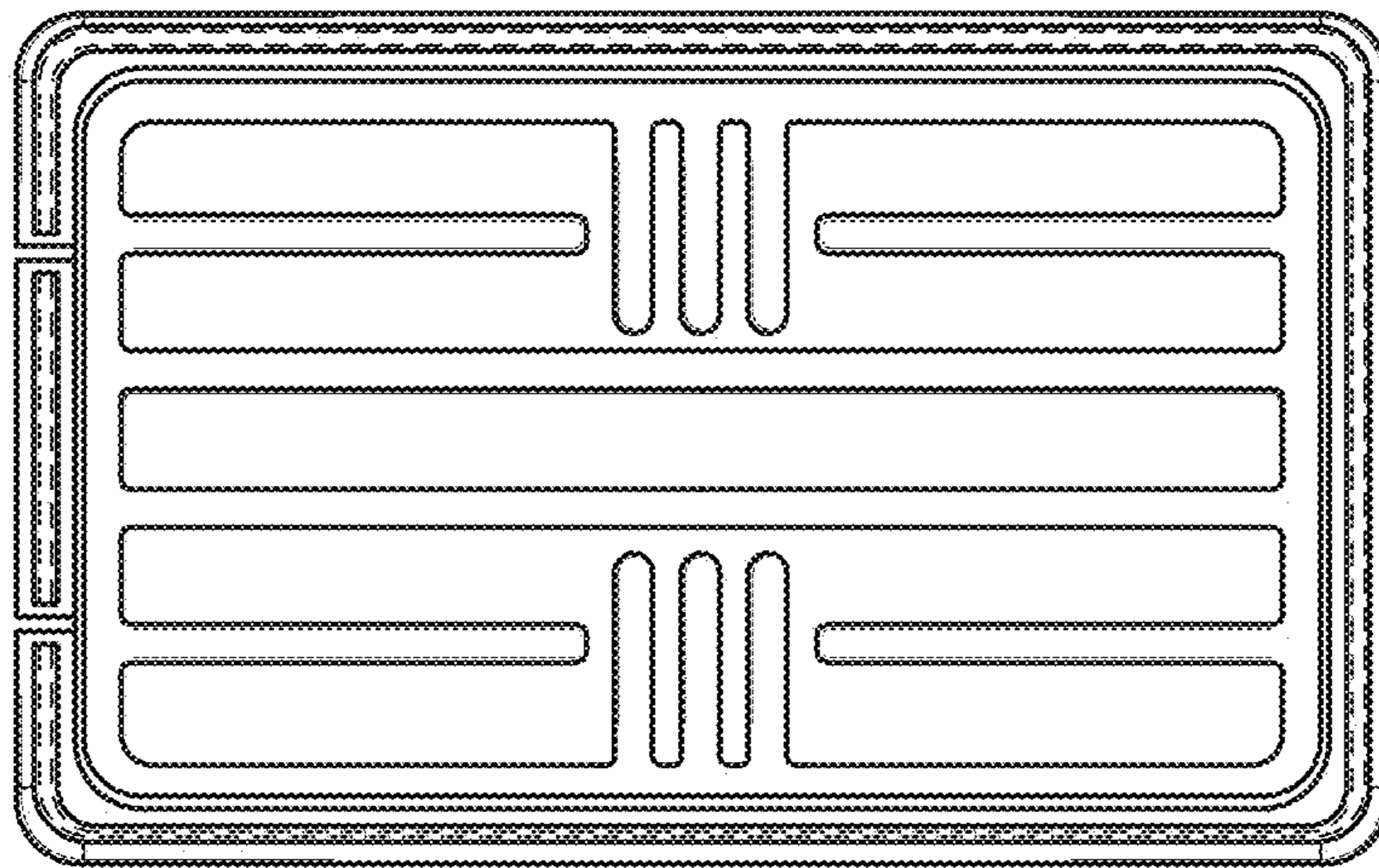

Fig. 20

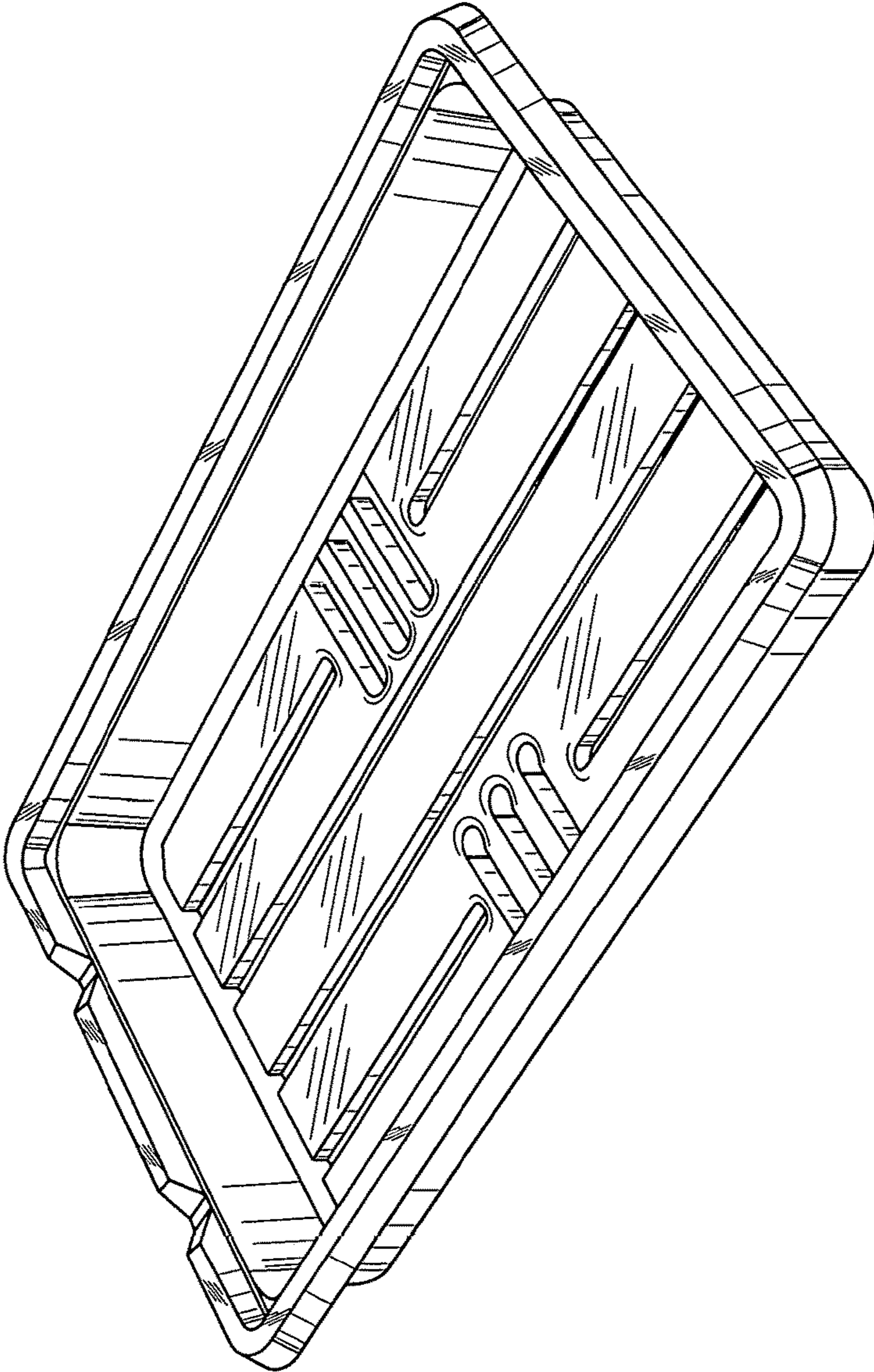

Fig. 21

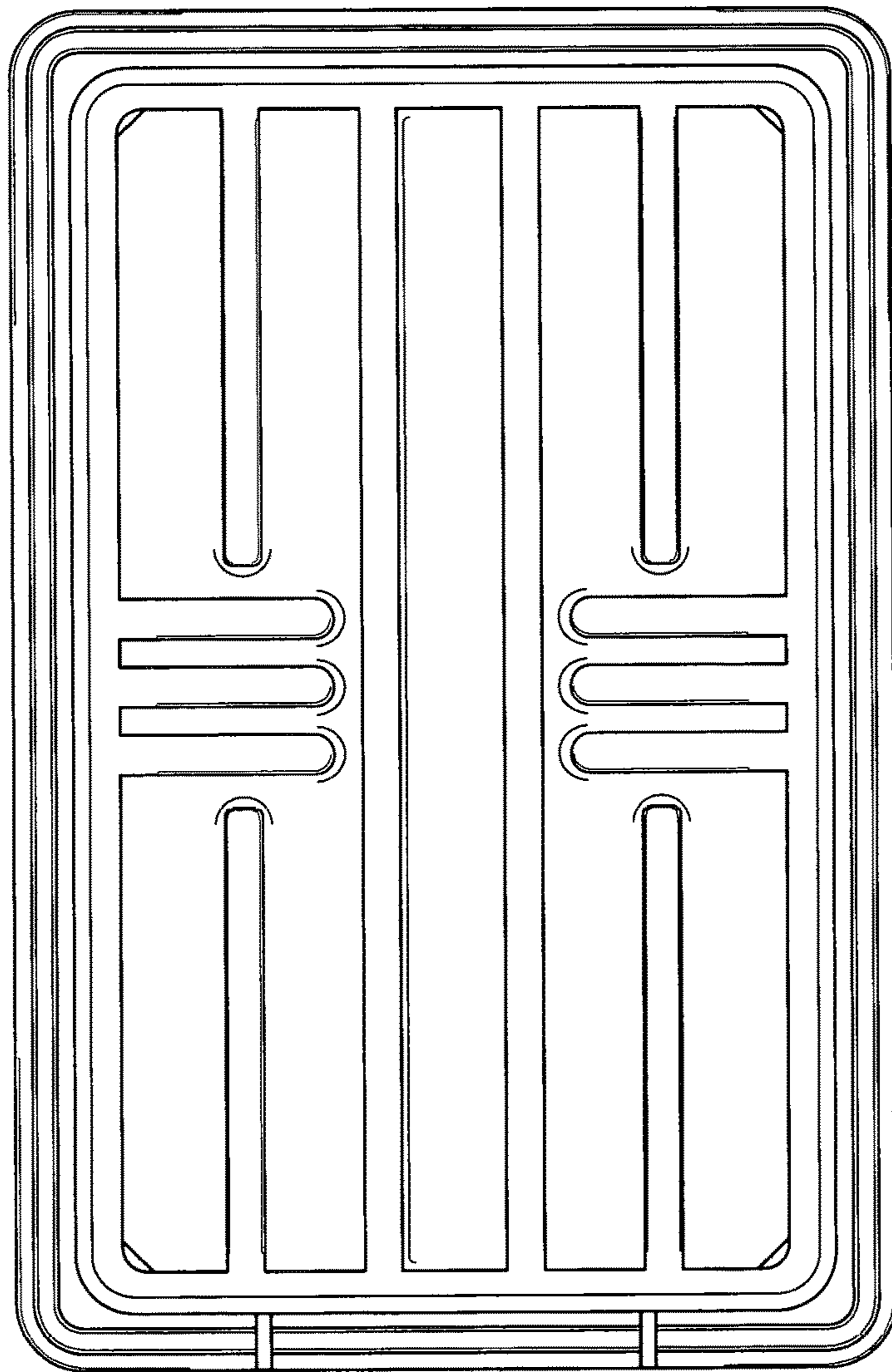

Fig. 22



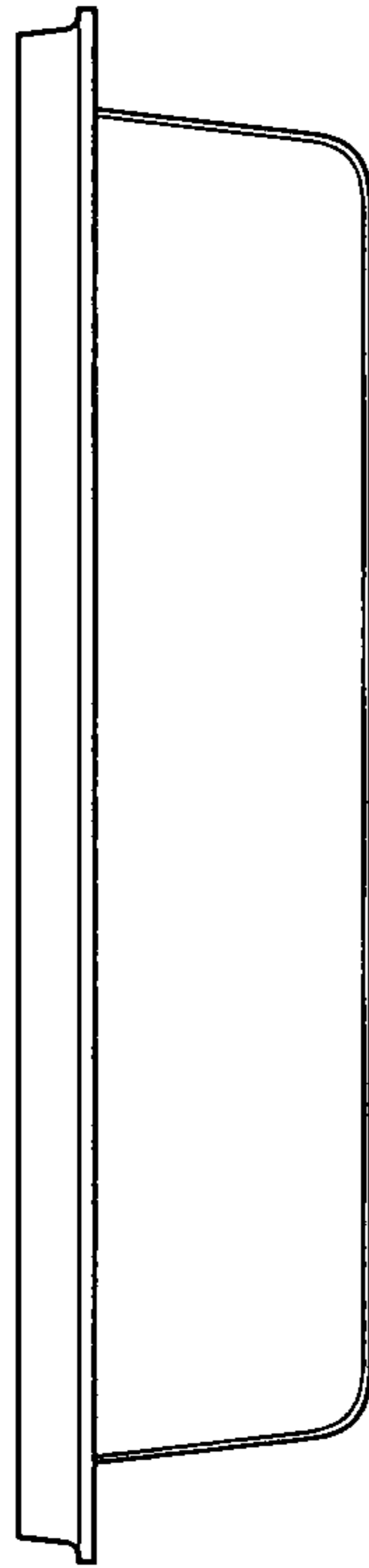

Fig. 23

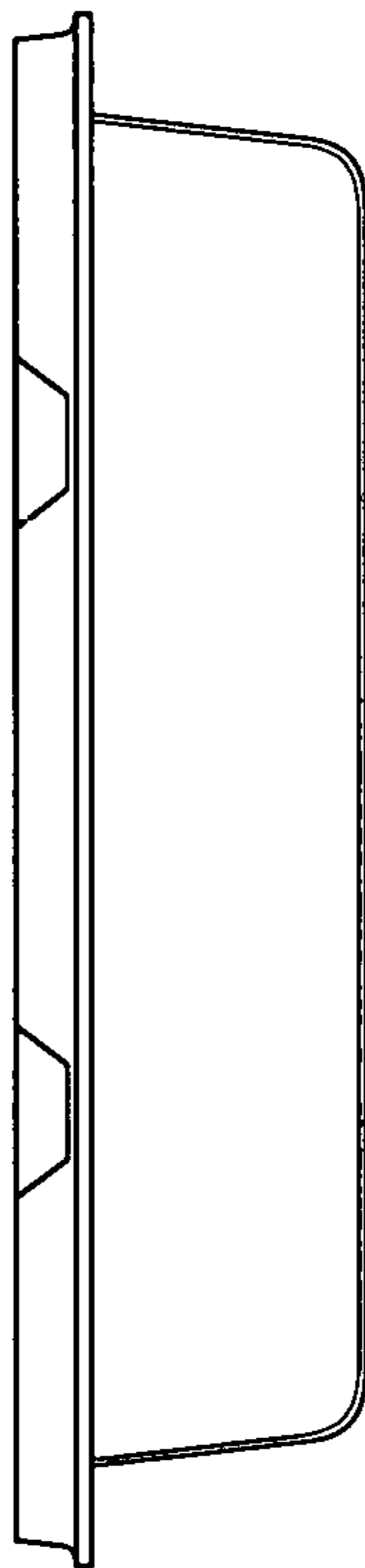

Fig. 24

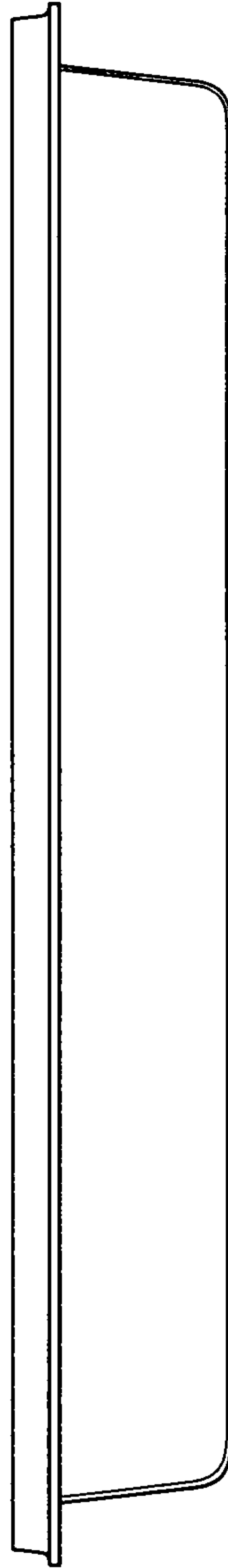

Fig. 25

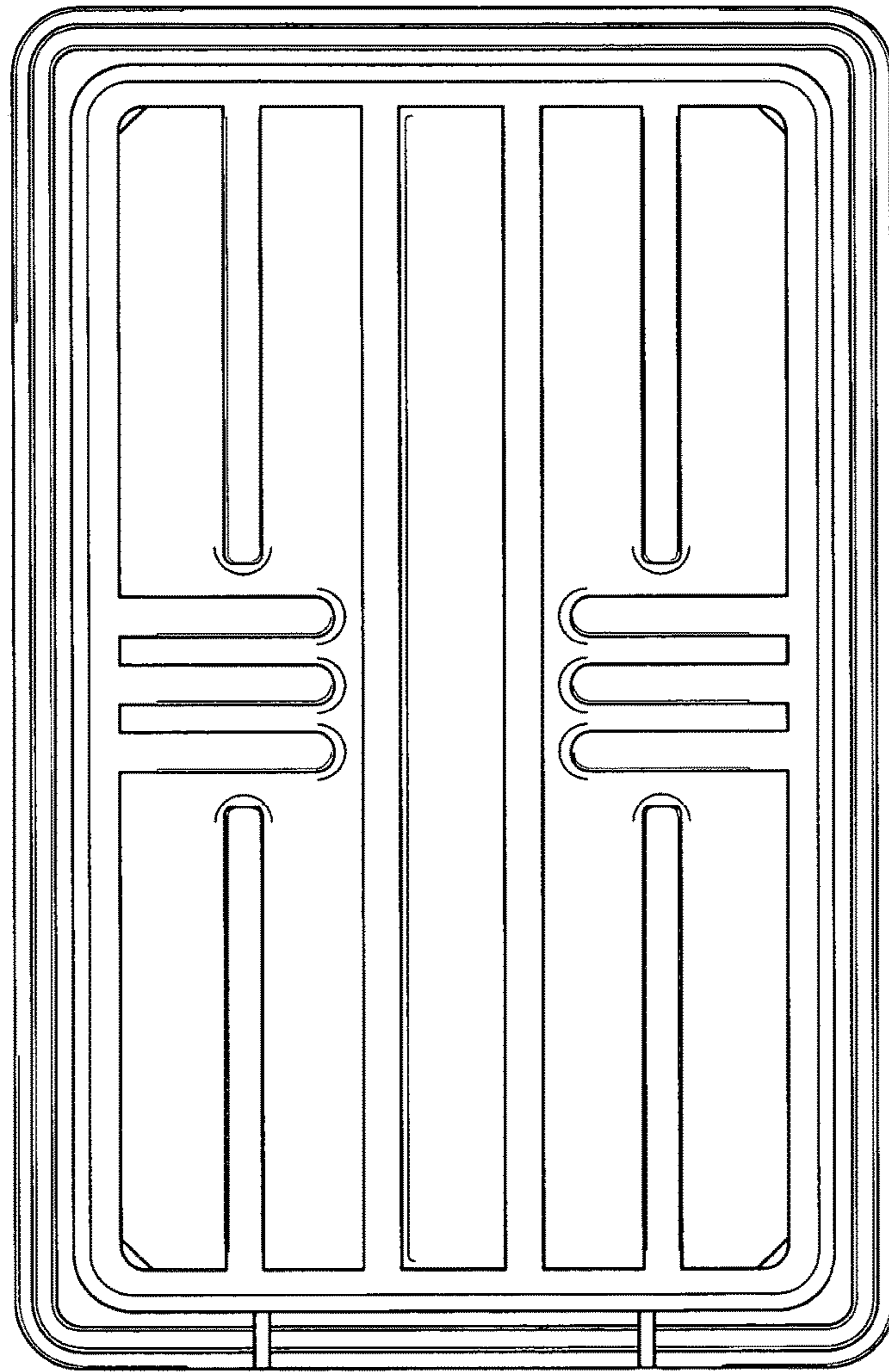

Fig. 26

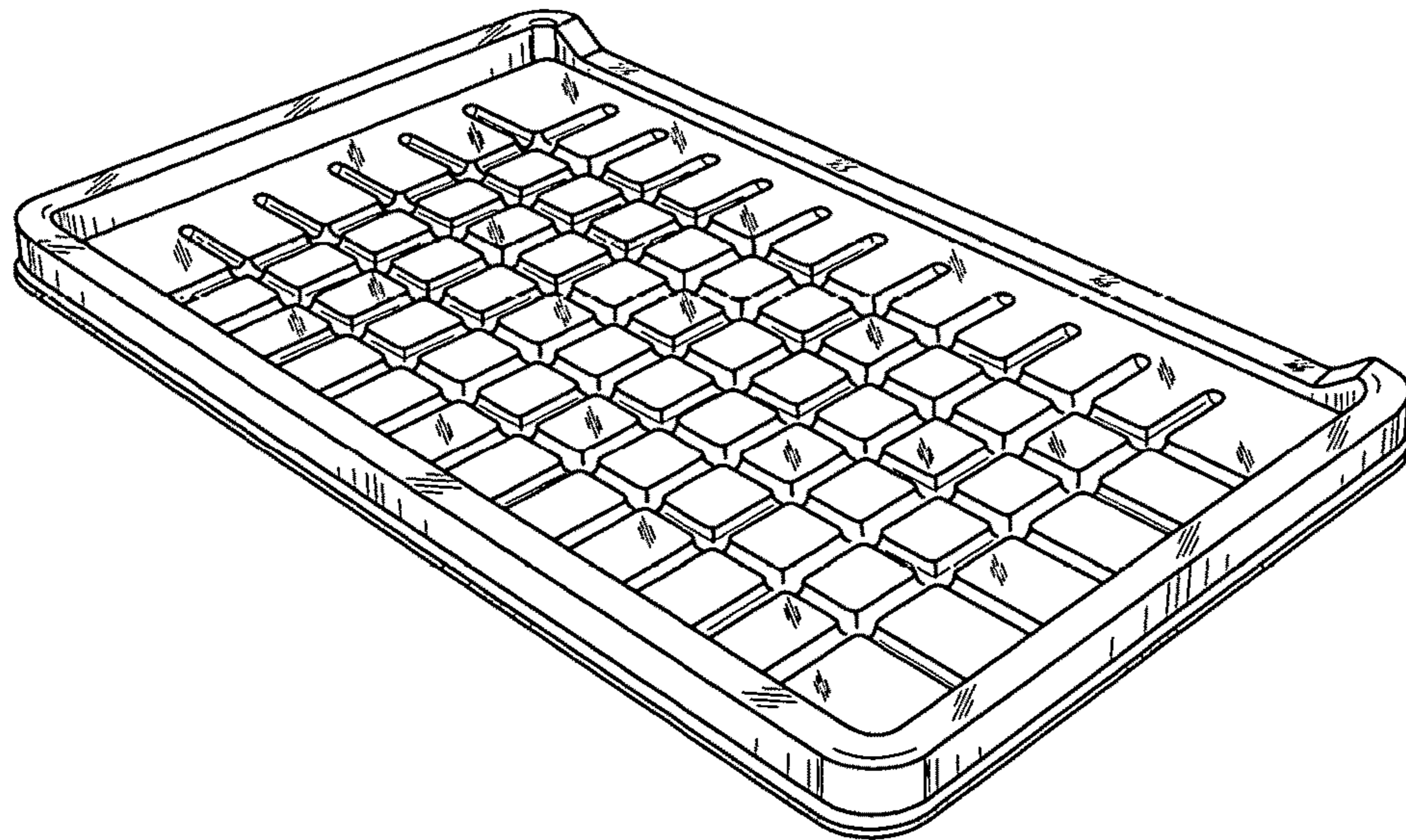

Fig. 27

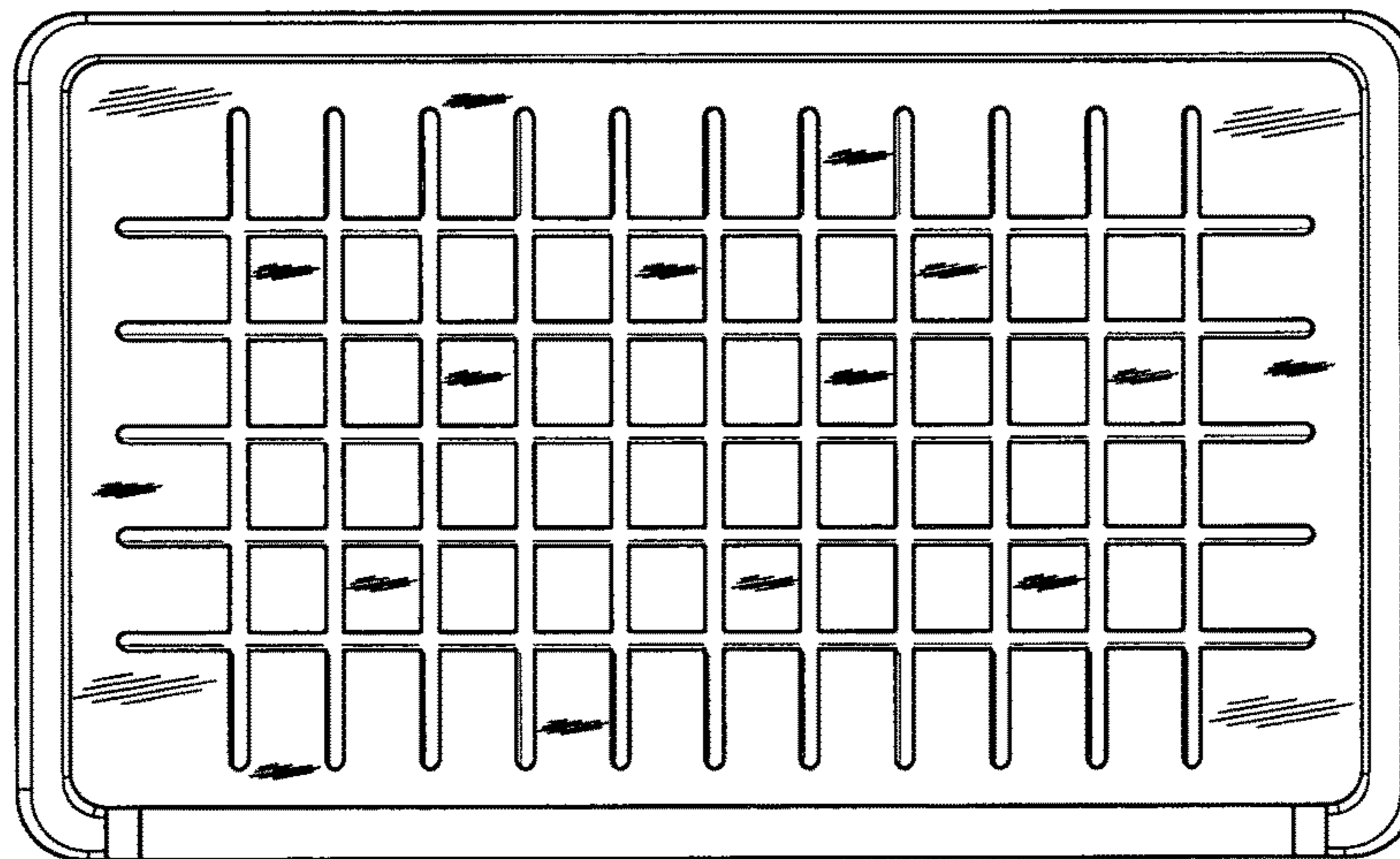

Fig. 28

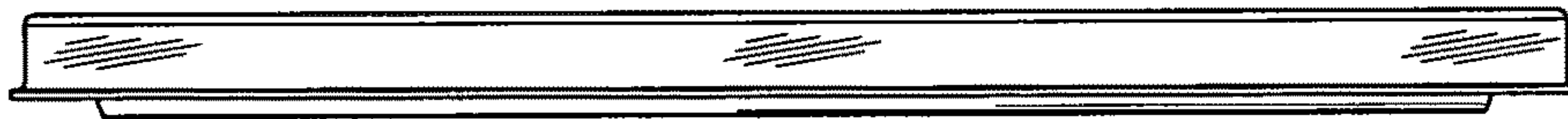

Fig. 29

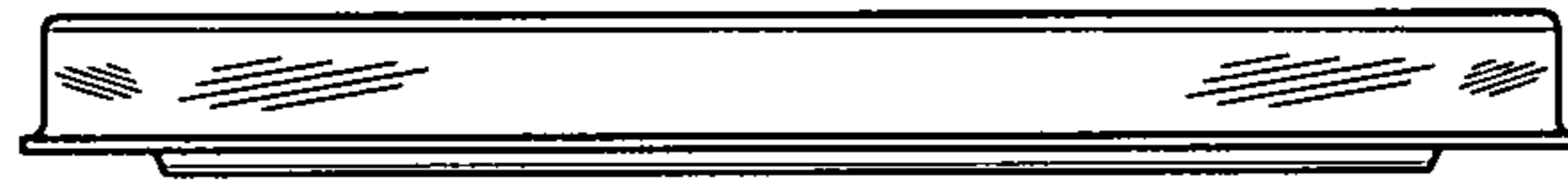

Fig. 30



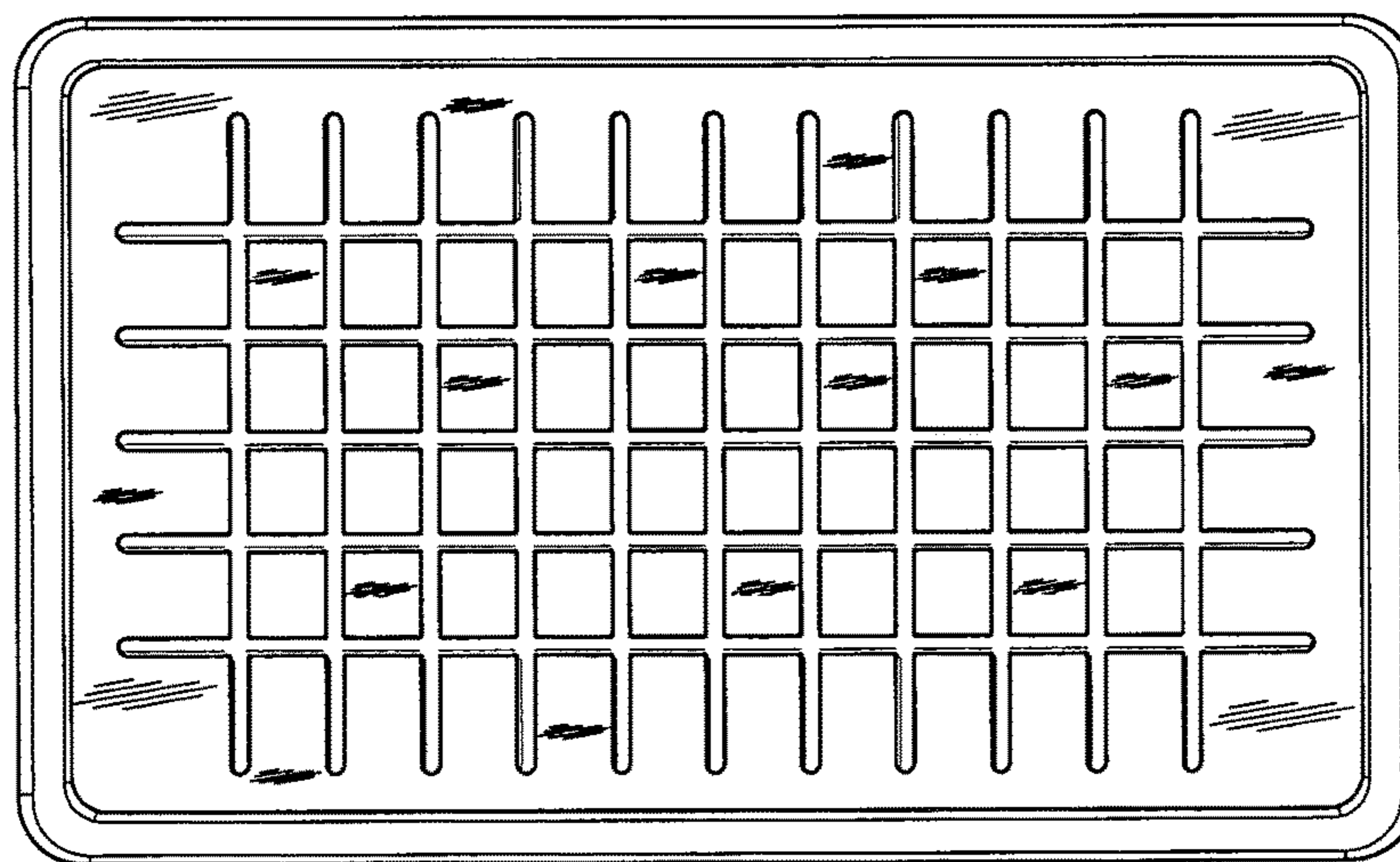

Fig. 31