



US00D781288S

(12) **United States Design Patent**  
**Park et al.**

(10) **Patent No.:** **US D781,288 S**  
(45) **Date of Patent:** **\*\* Mar. 14, 2017**

(54) **HEAD MOUNT DISPLAY**

(71) Applicant: **LG ELECTRONICS INC.**, Seoul  
(KR)

(72) Inventors: **Seala Park**, Seoul (KR); **Dongsoon Kim**, Seoul (KR); **Seungyup Lee**, Seoul (KR); **Hyunchul Kim**, Seoul (KR)

(73) Assignee: **LG ELECTRONICS INC.**, Seoul  
(KR)

(\*\*) Term: **15 Years**

(21) Appl. No.: **29/551,315**

(22) Filed: **Jan. 12, 2016**

(30) **Foreign Application Priority Data**

Jul. 13, 2015 (KR) ..... 30-2015-0035166

(51) **LOC (10) Cl.** ..... **14-02**

(52) **U.S. Cl.**  
USPC ..... **D14/372**

(58) **Field of Classification Search**  
USPC ..... D14/372, 496, 432, 371, 125, 126, 129,  
D14/299; D16/300-342; 351/158, 153,  
351/144; 345/7-9, 905; 455/344;  
348/115, 53, 121, 739  
CPC ..... G02B 27/017; G02B 27/0158; G02B  
27/0161; G02B 27/0181; G02B 27/0185;  
G02B 27/0189

See application file for complete search history.

(56) **References Cited**

**U.S. PATENT DOCUMENTS**

D722,054 S \* 2/2015 Serota ..... D14/372  
D727,318 S \* 4/2015 Garcia Marin ..... D14/372

D732,028 S \* 6/2015 Kim ..... D14/372  
D739,855 S \* 9/2015 Bosveld ..... D14/372  
D740,283 S \* 10/2015 Bosveld ..... D14/372  
D741,324 S \* 10/2015 Bosveld ..... D14/372

(Continued)

*Primary Examiner* — Austin Murphy

(74) *Attorney, Agent, or Firm* — Birch, Stewart, Kolasch & Birch, LLP

(57) **CLAIM**

The ornamental design for a head mount display, as shown and described.

**DESCRIPTION**

FIG. 1 is a front perspective view of a head mount display showing our new design;

FIG. 2 is a front view thereof;

FIG. 3 is a rear view thereof;

FIG. 4 is a left side view thereof;

FIG. 5 is a right side view thereof;

FIG. 6 is a top plan view thereof;

FIG. 7 is a bottom plan view thereof;

FIG. 8 is a rear perspective view thereof;

FIG. 9 is a reference view thereof showing an example of the usage of the subject design in which the user wears the subject design;

FIG. 10 is a front perspective view thereof in a condition that the side of the main body is lengthened;

FIG. 11 is a left side view of FIG. 10;

FIG. 12 is a right side view of FIG. 10;

FIG. 13 is a top plan view of FIG. 10;

FIG. 14 is a bottom plan view of FIG. 10;

FIG. 15 is a rear perspective view of FIG. 10; and,

FIG. 16 is a reference view of FIG. 10 showing an example of the usage of the subject design in which the user wears the subject design.

The broken lines depict portions of the head mount display that form no part of the claimed design.

**1 Claim, 16 Drawing Sheets**

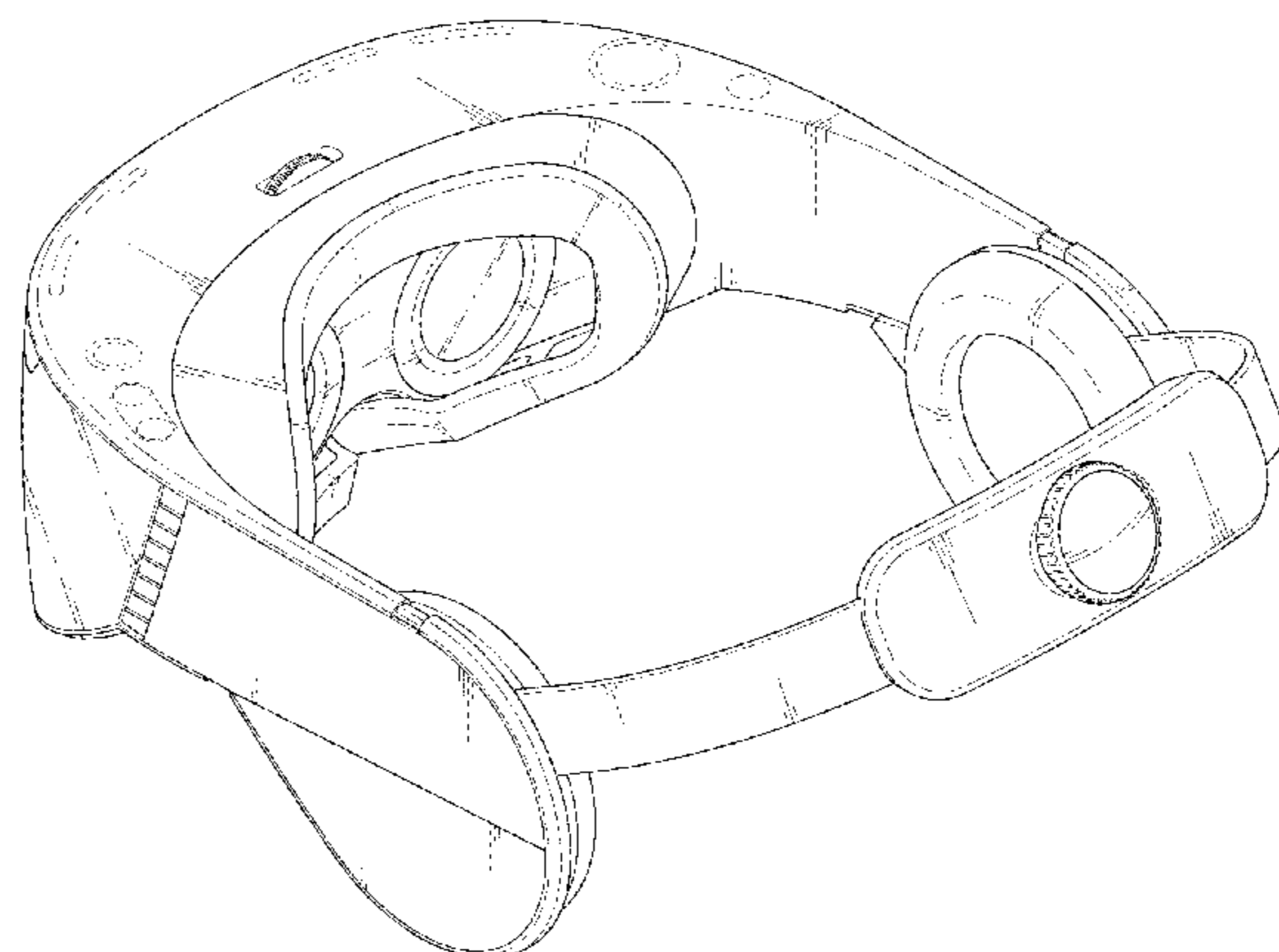
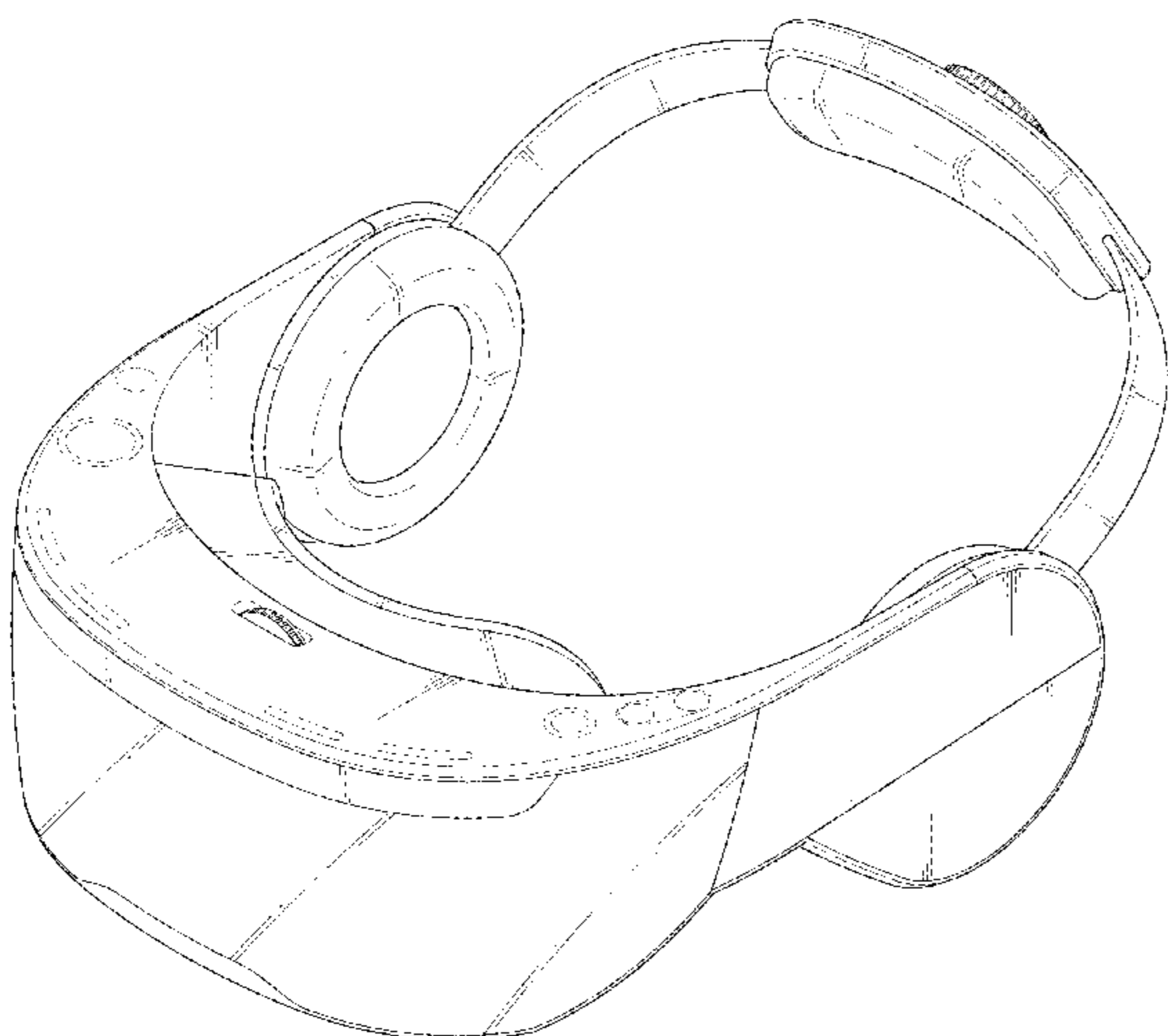

(56)

**References Cited**

U.S. PATENT DOCUMENTS

D749,580 S *	2/2016	Kim .....	D14/372
D753,111 S *	4/2016	Fei .....	D14/372
D753,113 S *	4/2016	Fei .....	D14/372
D764,467 S *	8/2016	Nokuo .....	D14/372

\* cited by examiner

FIG. 1

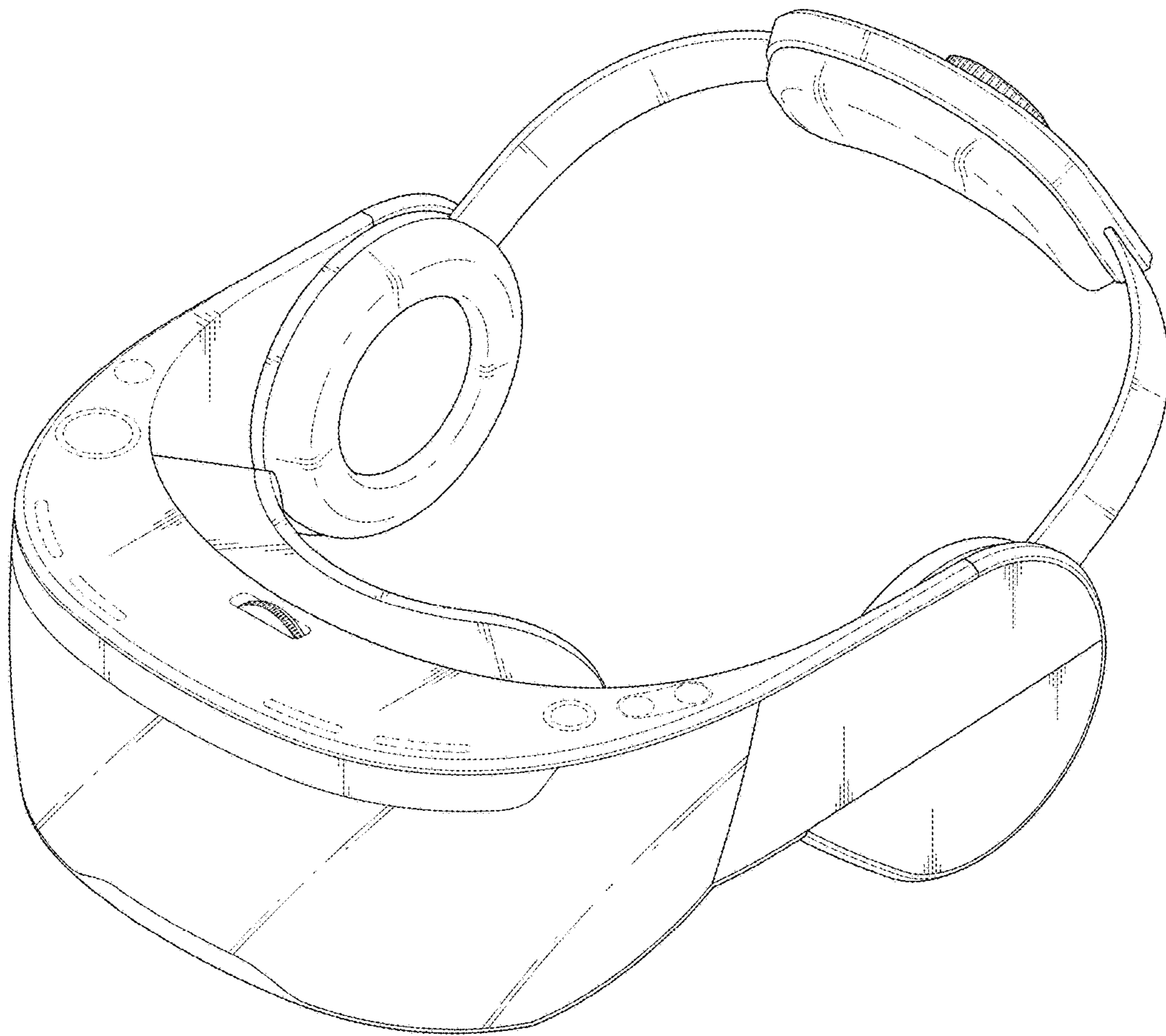

FIG. 2

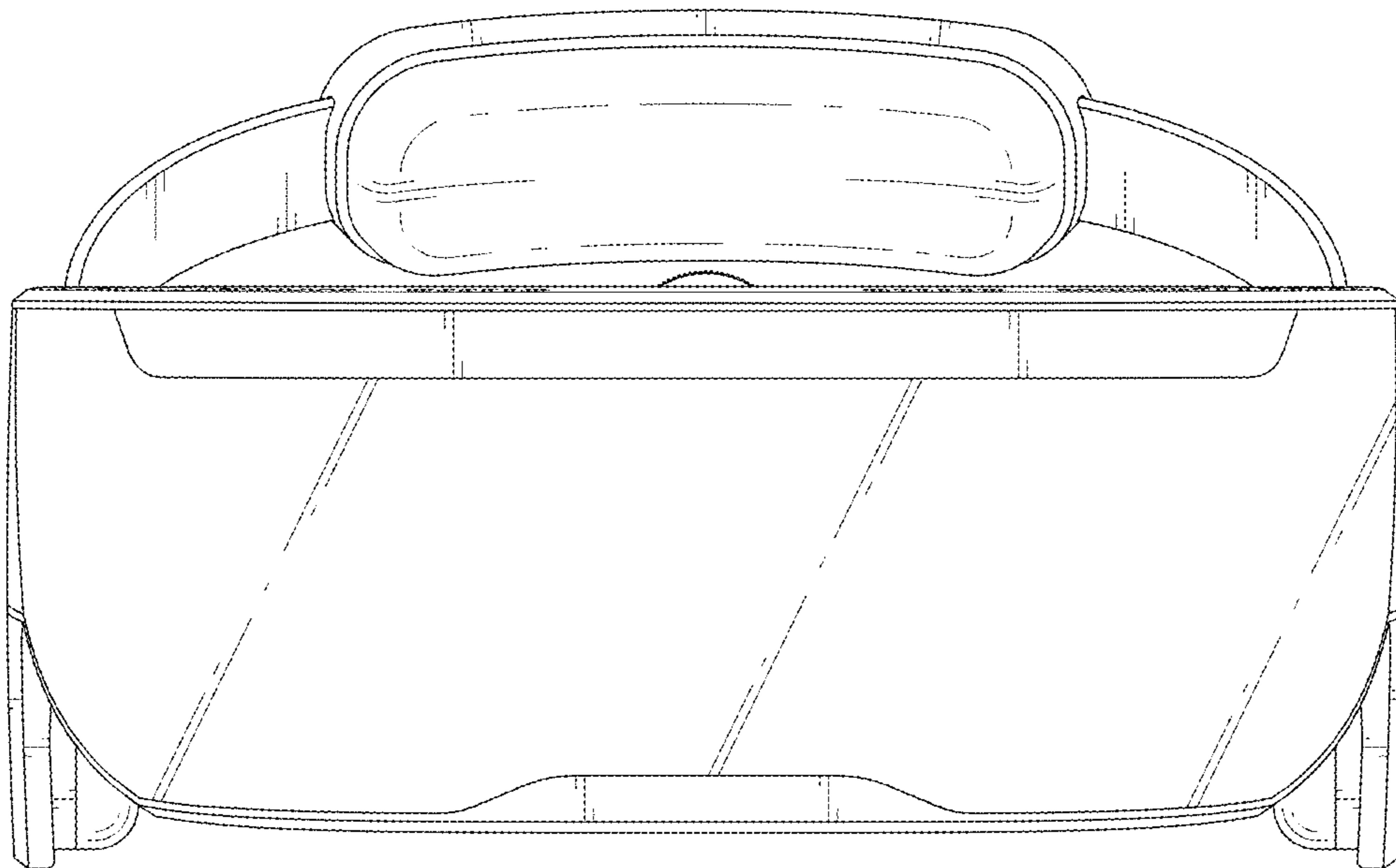

FIG. 3

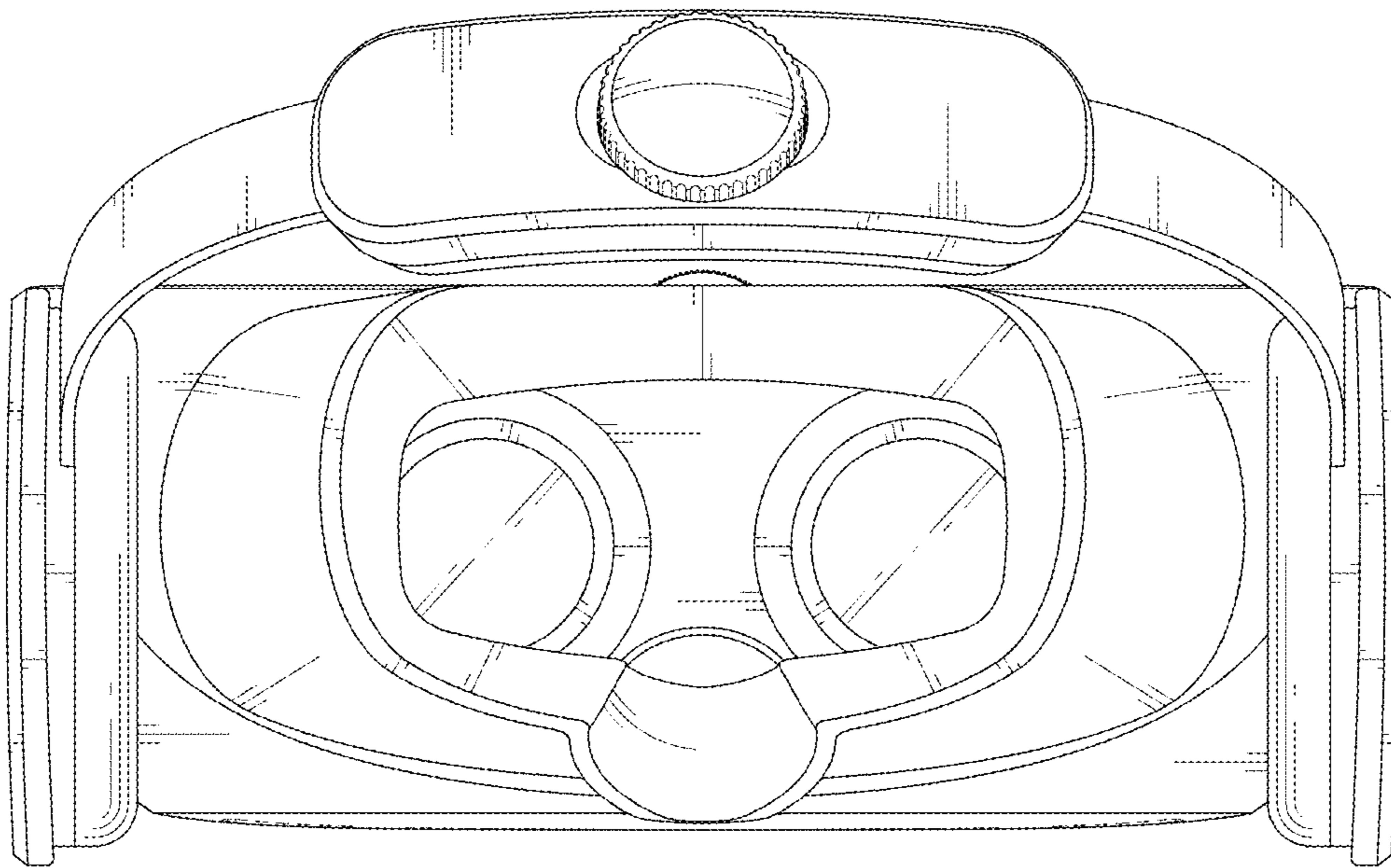

FIG. 4

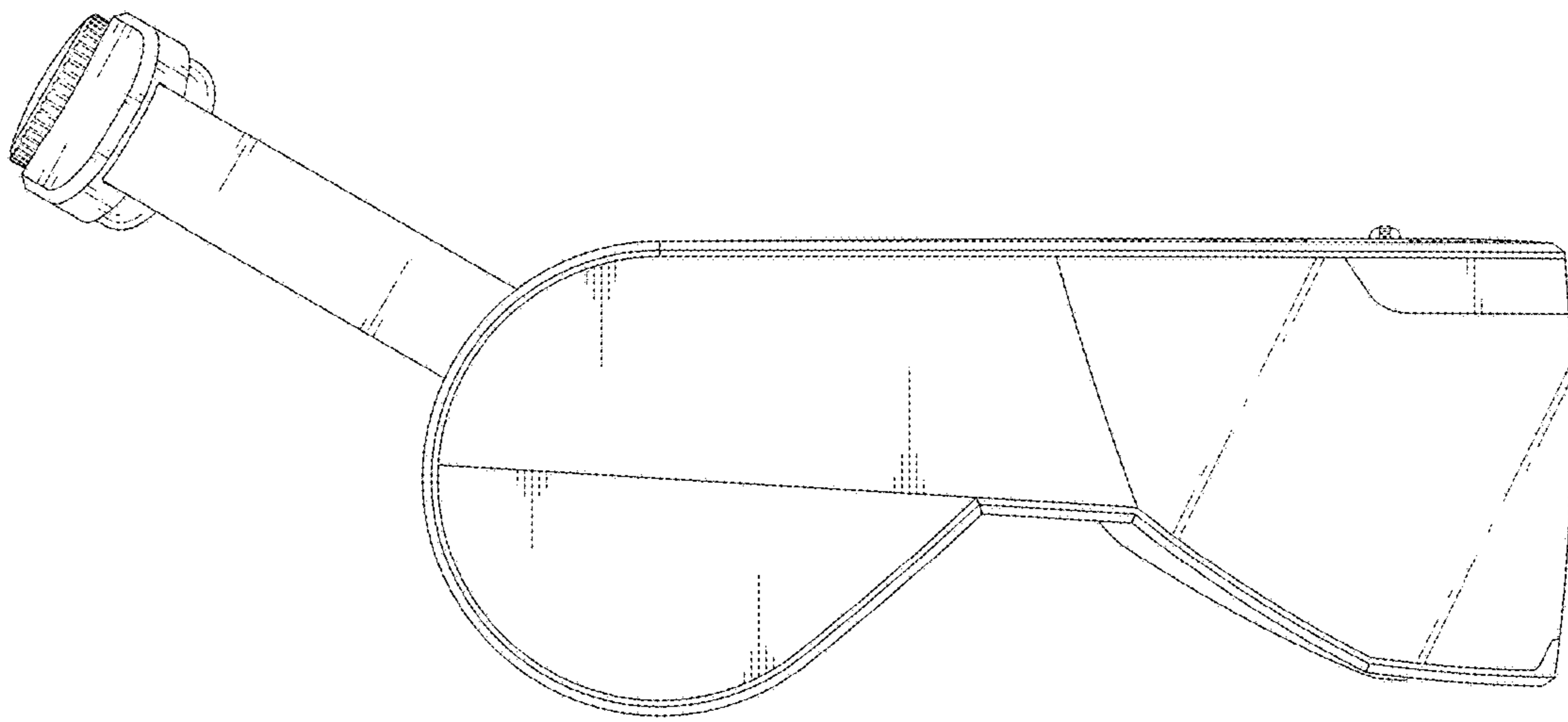

FIG. 5

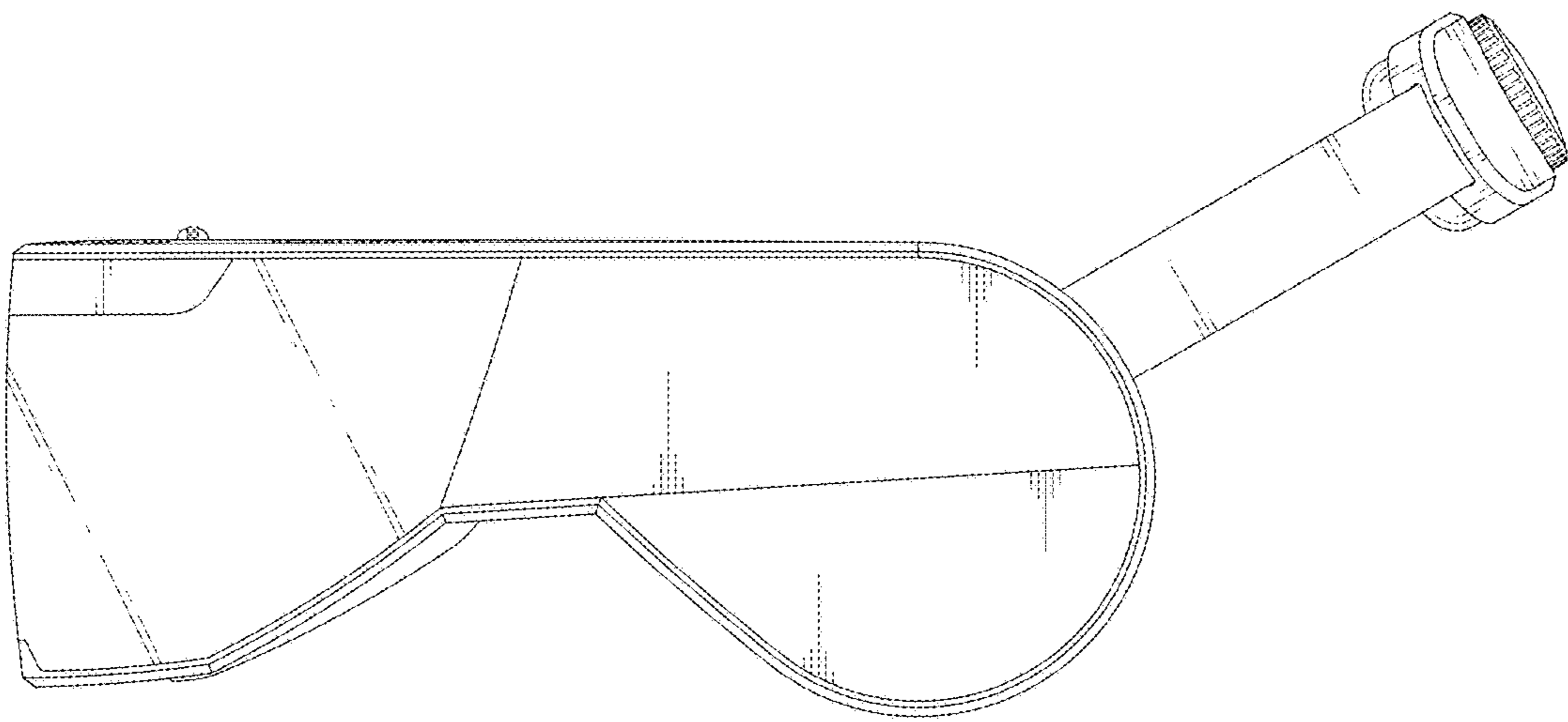

FIG. 6

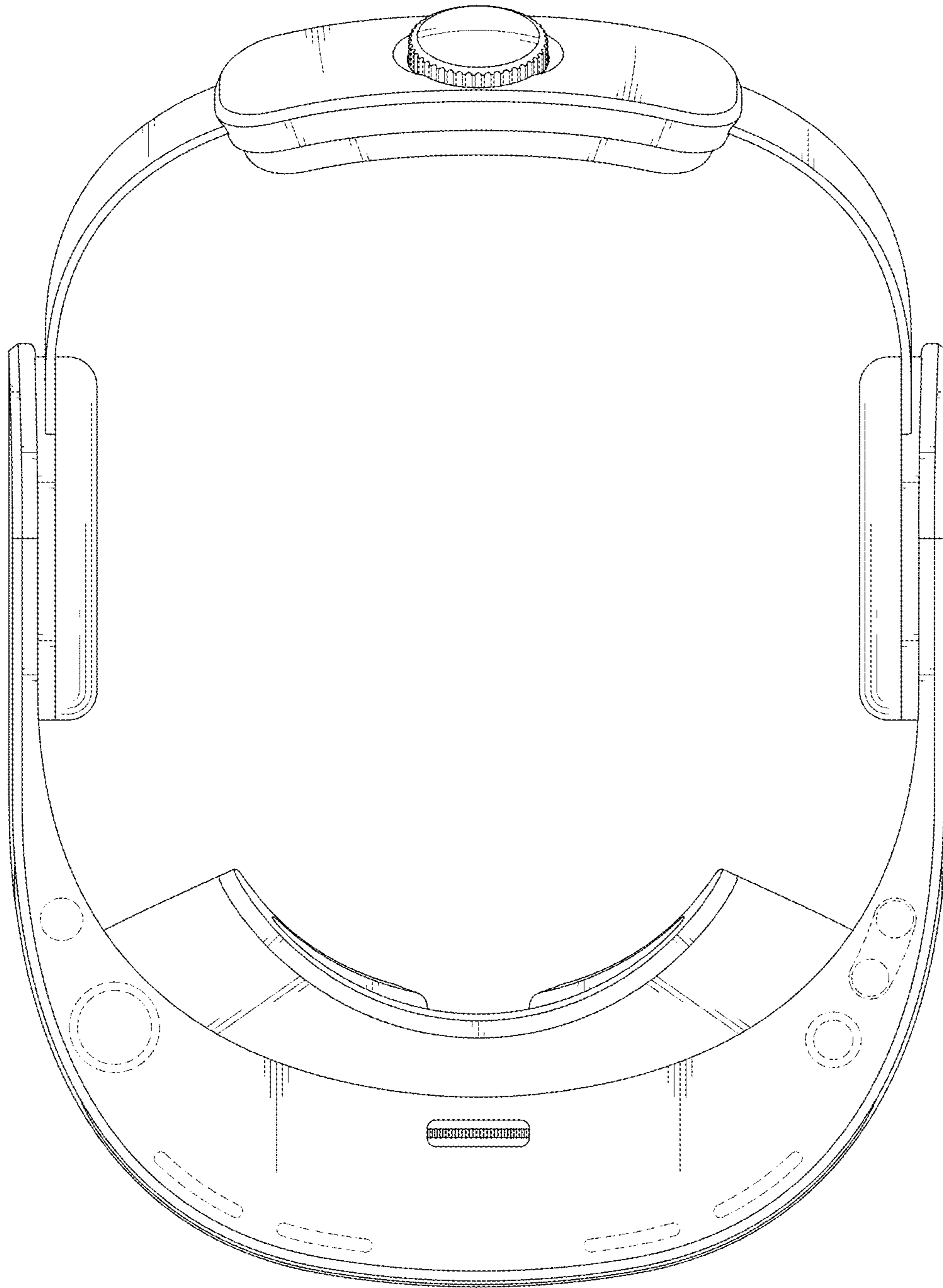



FIG. 7

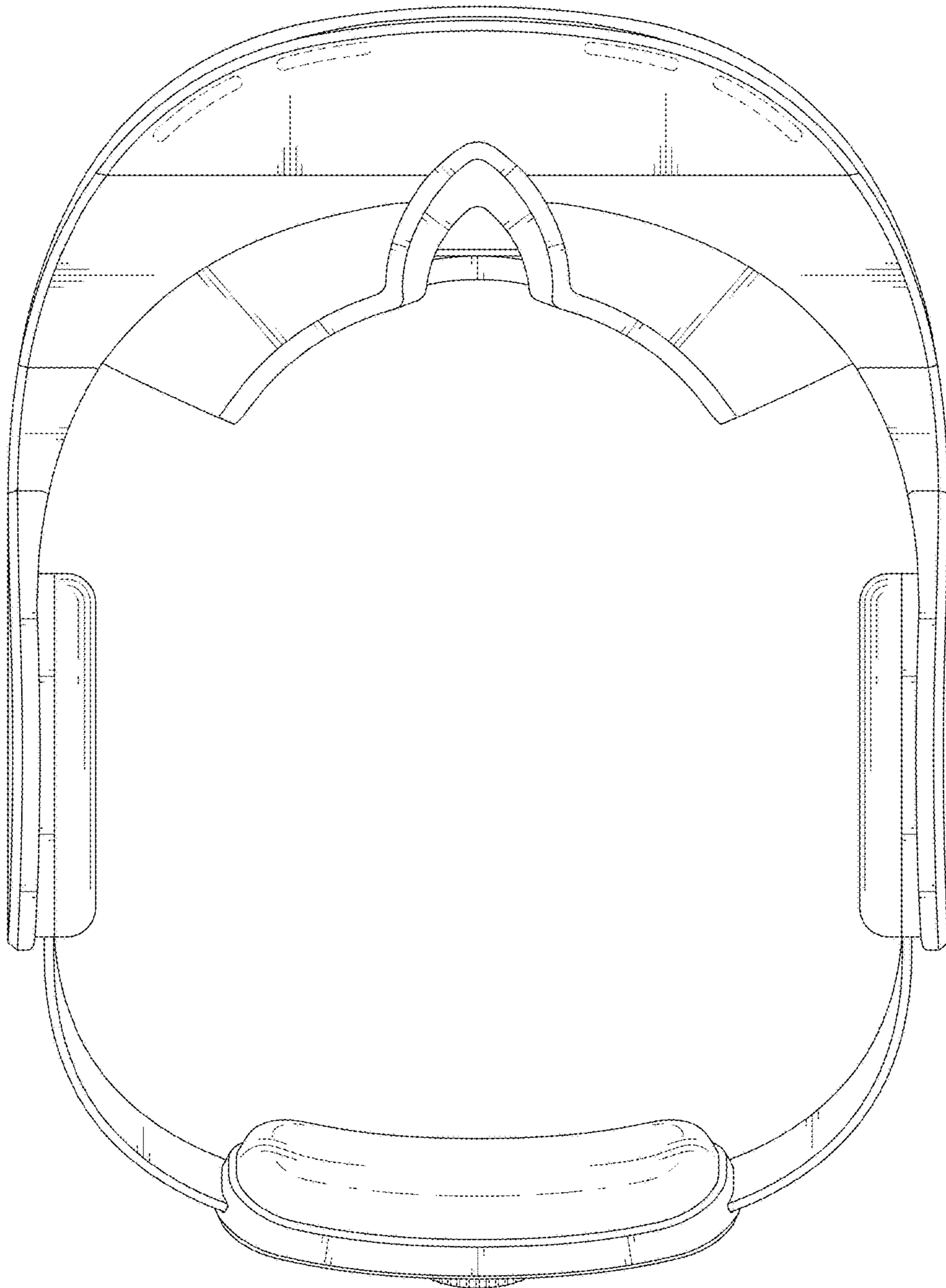

FIG. 8

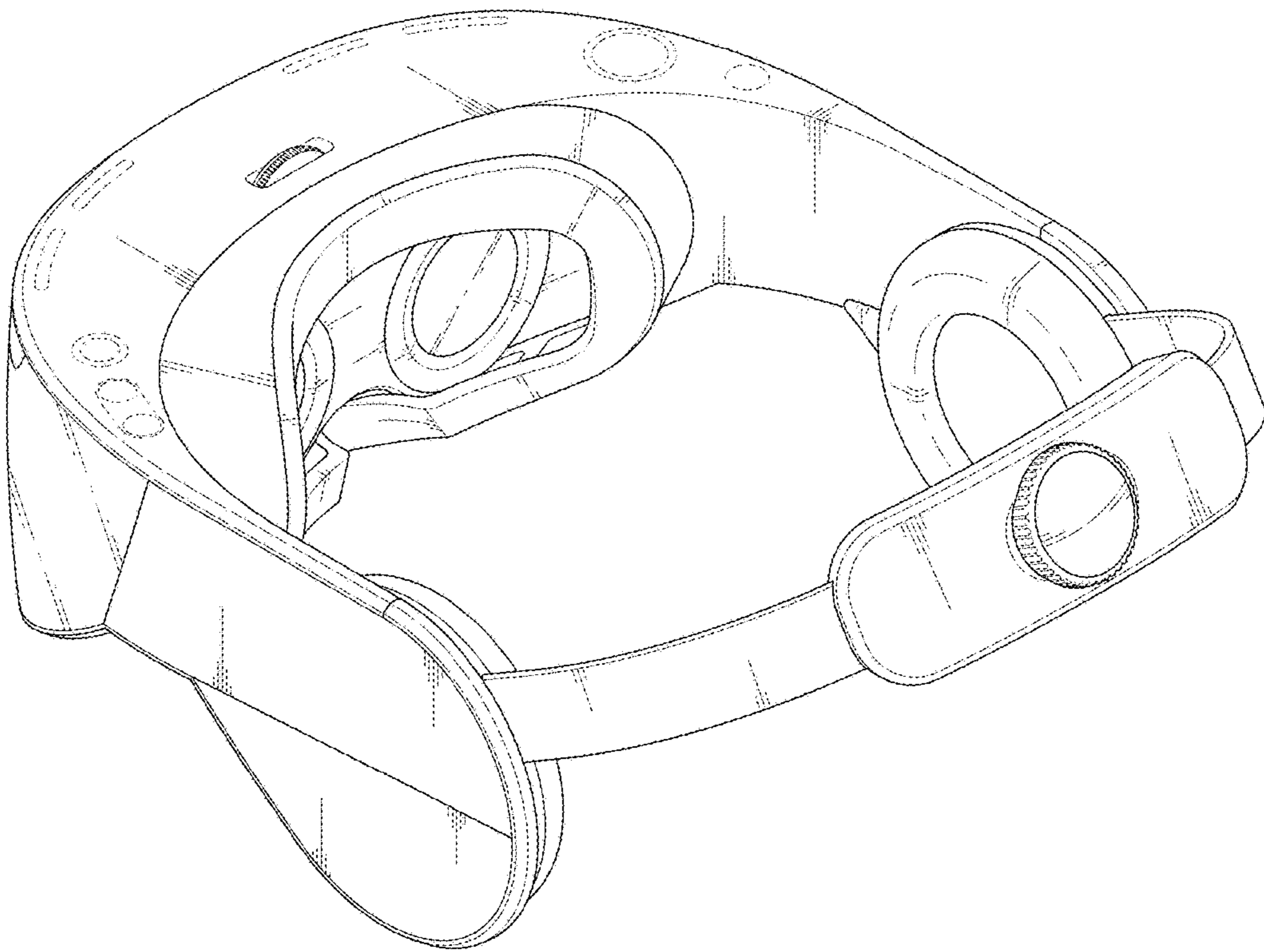

FIG. 9

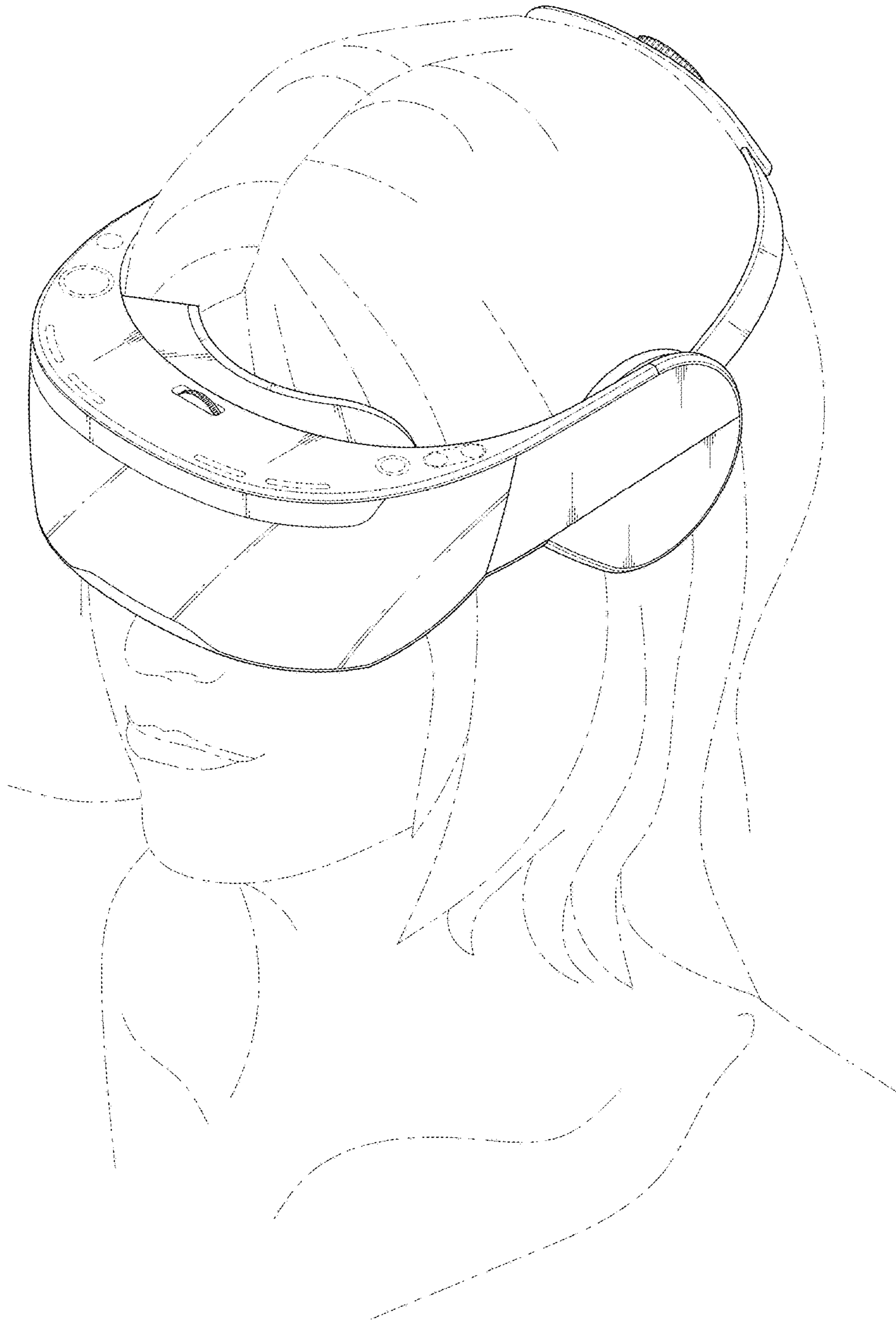

FIG. 10

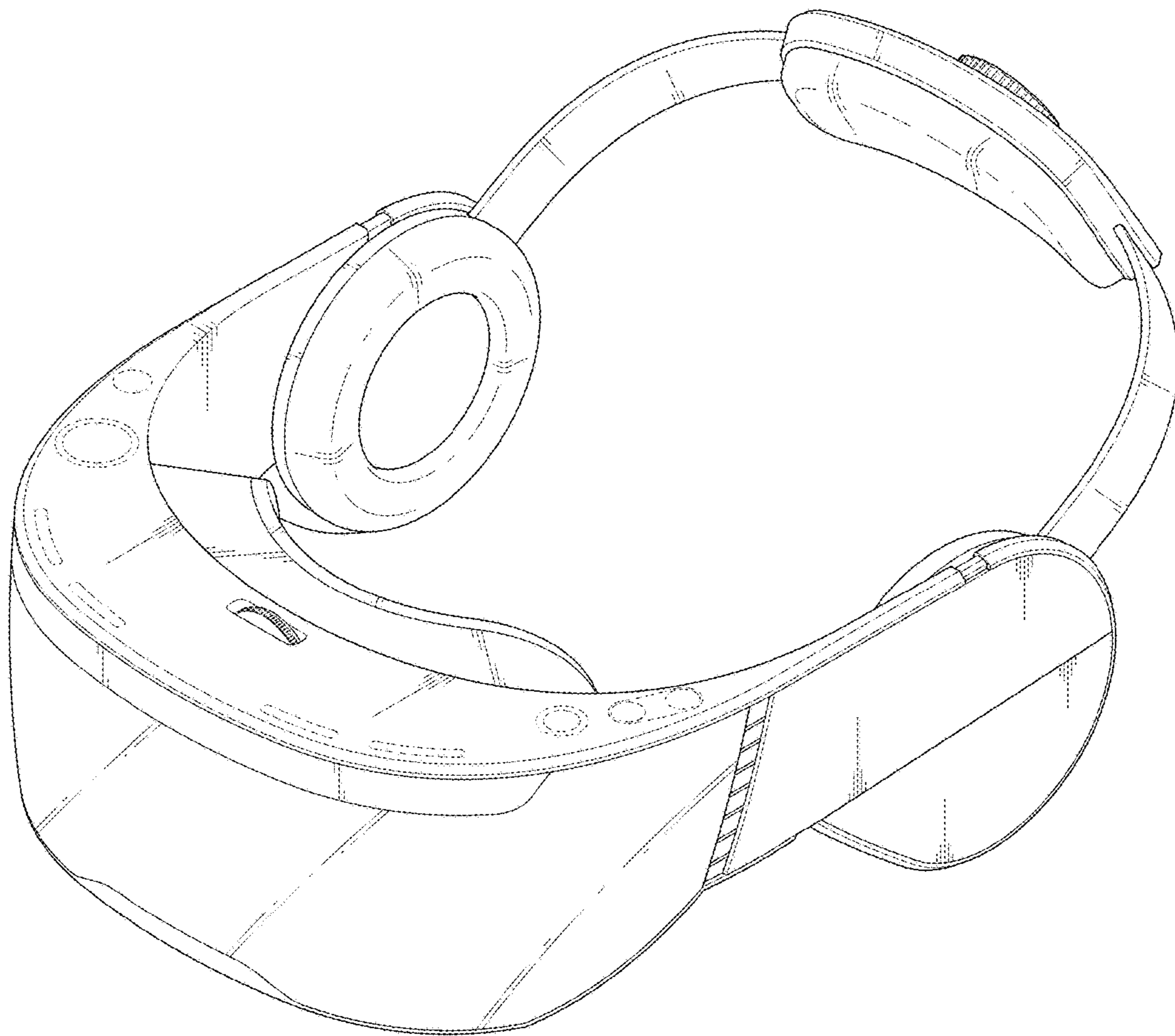

FIG. 11

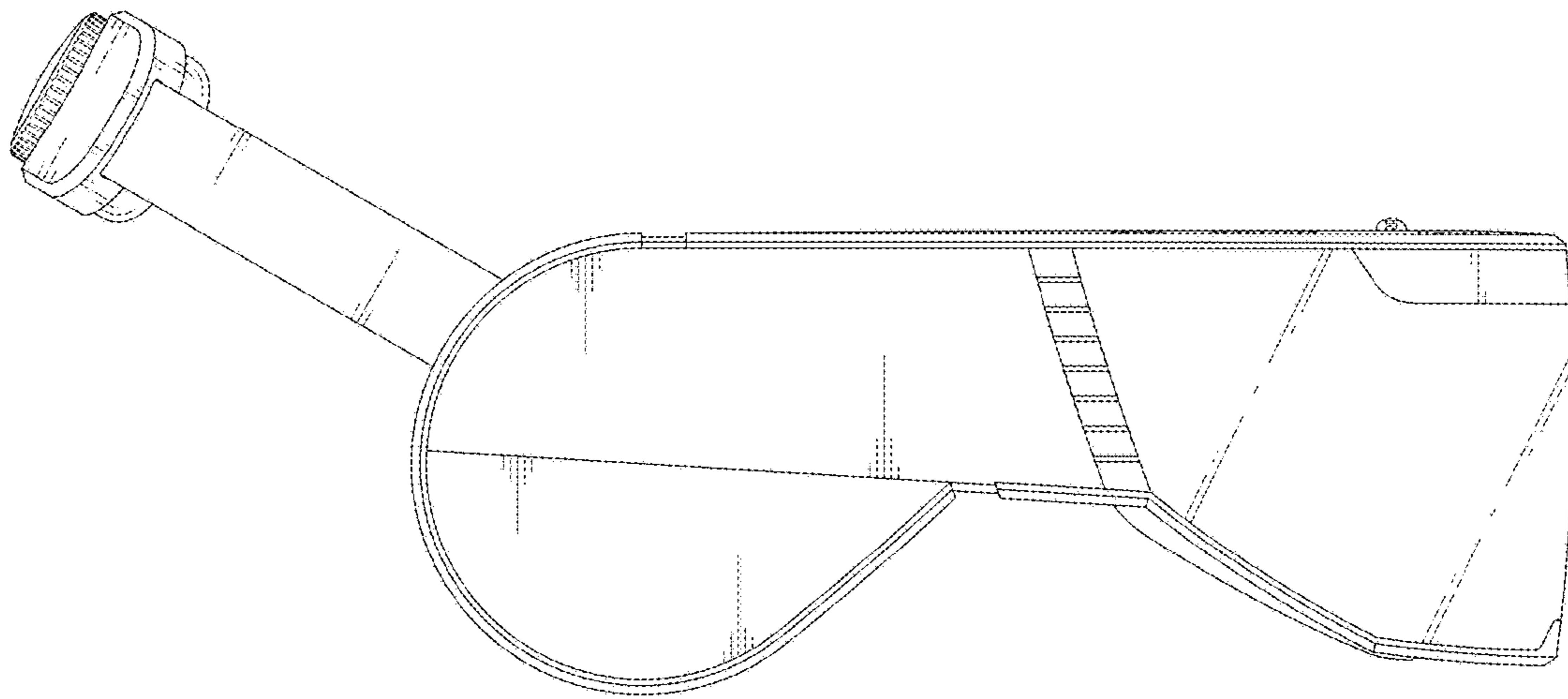

FIG. 12

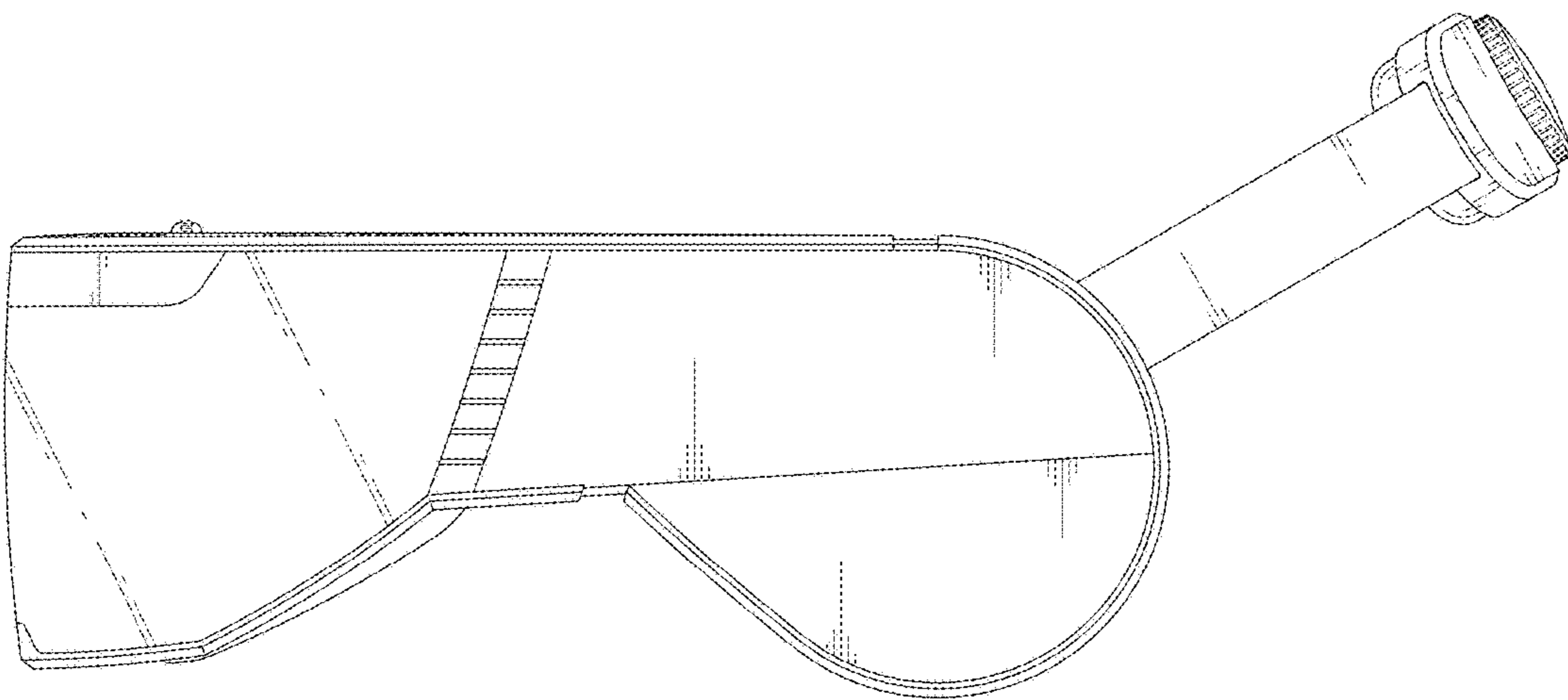

FIG. 13

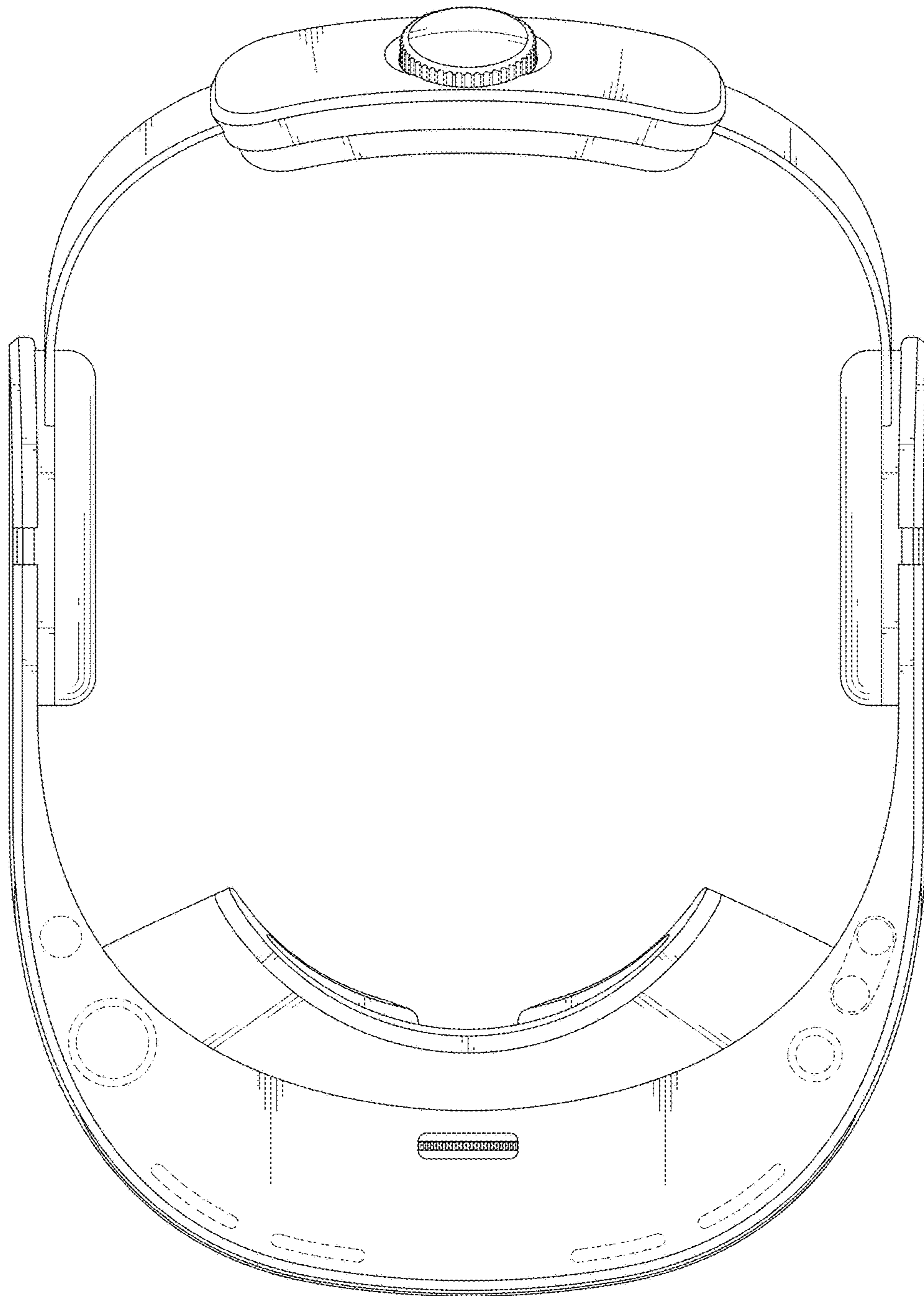

FIG. 14

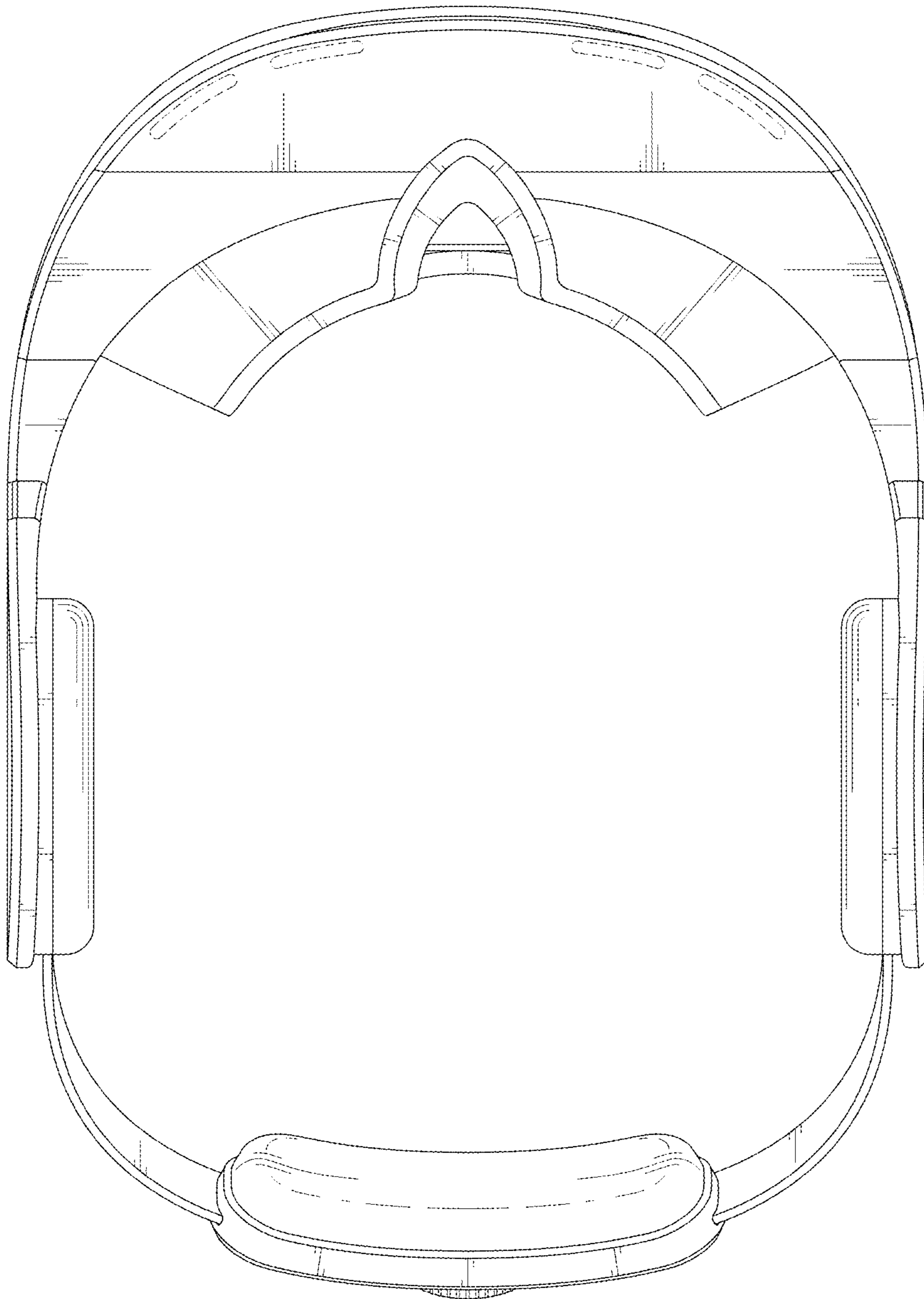



FIG. 15

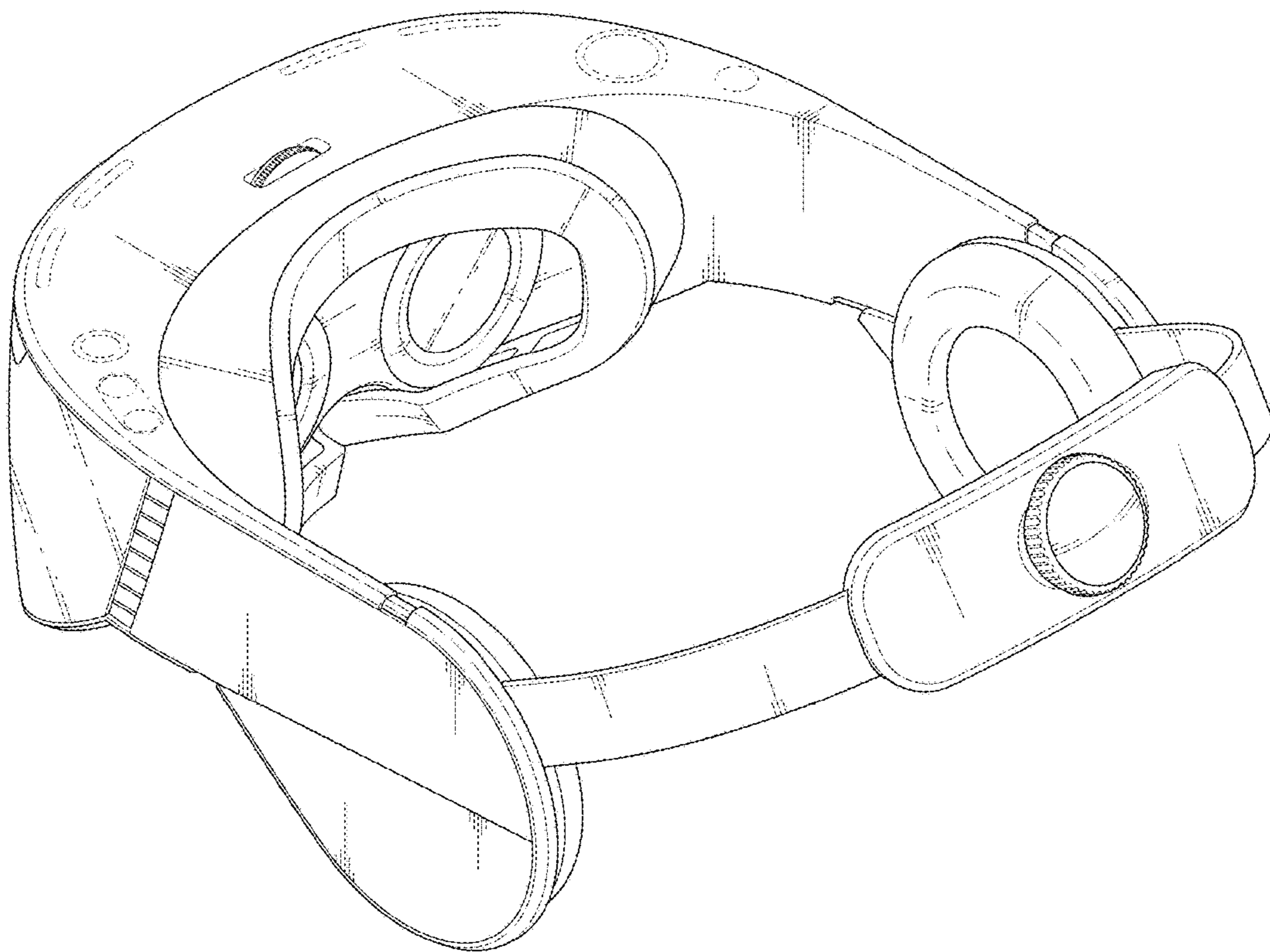

FIG. 16

