



US00D781259S

(12) **United States Design Patent**
Song et al.

(10) **Patent No.: US D781,259 S**
(45) **Date of Patent: ** Mar. 14, 2017**

(54) **TELEVISION RECEIVER**

(71) Applicants: **LG Display Co., Ltd.**, Seoul (KR);
Sookmyung Women's University
Industry Academic Cooperation,
Seoul (KR)

(72) Inventors: **Hyun Jin Song**, Jeonju-si (KR); **Ji**
Woon Min, Anyang-si (KR); **Young**
Nam Lee, Incheon (KR); **Il Yong Kim**,
Daejeon (KR); **Sang Eun Lee**,
Goyang-si (KR); **Jang Hyun Cho**,
Seoul (KR); **Heung Ryeol Kim**, Seoul
(KR); **Chang Kuk You**, Seoul (KR);
Eun Byul Ko, Seoul (KR)

(73) Assignees: **LG DISPLAY CO., LTD.**, Seoul (KR);
SOOKMYUNG WOMEN'S
UNIVERSITY INDUSTRY
ACADEMIC COOPERATION, Seoul
(KR)

(**) Term: **15 Years**

(21) Appl. No.: **29/559,084**

(22) Filed: **Mar. 24, 2016**

(30) **Foreign Application Priority Data**

Sep. 25, 2015 (KR) 30-2015-0049040

(51) **LOC (10) Cl.** **14-03**

(52) **U.S. Cl.**
USPC **D14/126**

(58) **Field of Classification Search**
USPC D14/125-134, 239, 371, 136, 374-377,
D14/440, 450, 448, 336, 342, 159;
312/7.2; 348/836, 838, 180, 184, 325,
348/739; 248/917-924, 465; 345/104,
345/133, 156, 168, 87, 173; D21/329,
D21/515, 577, 622, 333, 433, 448, 452,

D21/450, 331, 505; D10/15, 26;
446/484, 175, 356; D6/477, 479, 300;
D20/10, 19, 39; D16/203, 241; 160/24
CPC G06F 1/1601; G06F 1/1643; G06F 1/1652;
G06F 1/1647; G06F 3/0412; H05K
5/0004; H05K 5/0017; H05K 5/02; H05K
5/0217; H04N 13/0459

See application file for complete search history.

(56) **References Cited**

U.S. PATENT DOCUMENTS

1,968,328 A * 7/1934 Stuparich B44C 3/10
40/735
D593,974 S * 6/2009 Yang D14/126
D605,149 S * 12/2009 Kim D14/126
D606,762 S * 12/2009 Tang D6/308

(Continued)

Primary Examiner — Raphael Barkai

(74) *Attorney, Agent, or Firm* — Birch, Stewart, Kolasch
& Birch, LLP

(57) **CLAIM**

The ornamental design for a television receiver, as shown
and described.

DESCRIPTION

FIG. 1 is a perspective view of a television receiver showing
our new design:

FIG. 2 is a front view thereof;

FIG. 3 is a rear view thereof;

FIG. 4 is a left side view thereof where the right side view
is a mirror image;

FIG. 5 is a top plan view thereof;

FIG. 6 is a bottom plan view thereof; and,

FIG. 7 is a rear perspective view thereof.

The broken lines depict portions of the television receiver
that form no part of the claimed design.

1 Claim, 6 Drawing Sheets

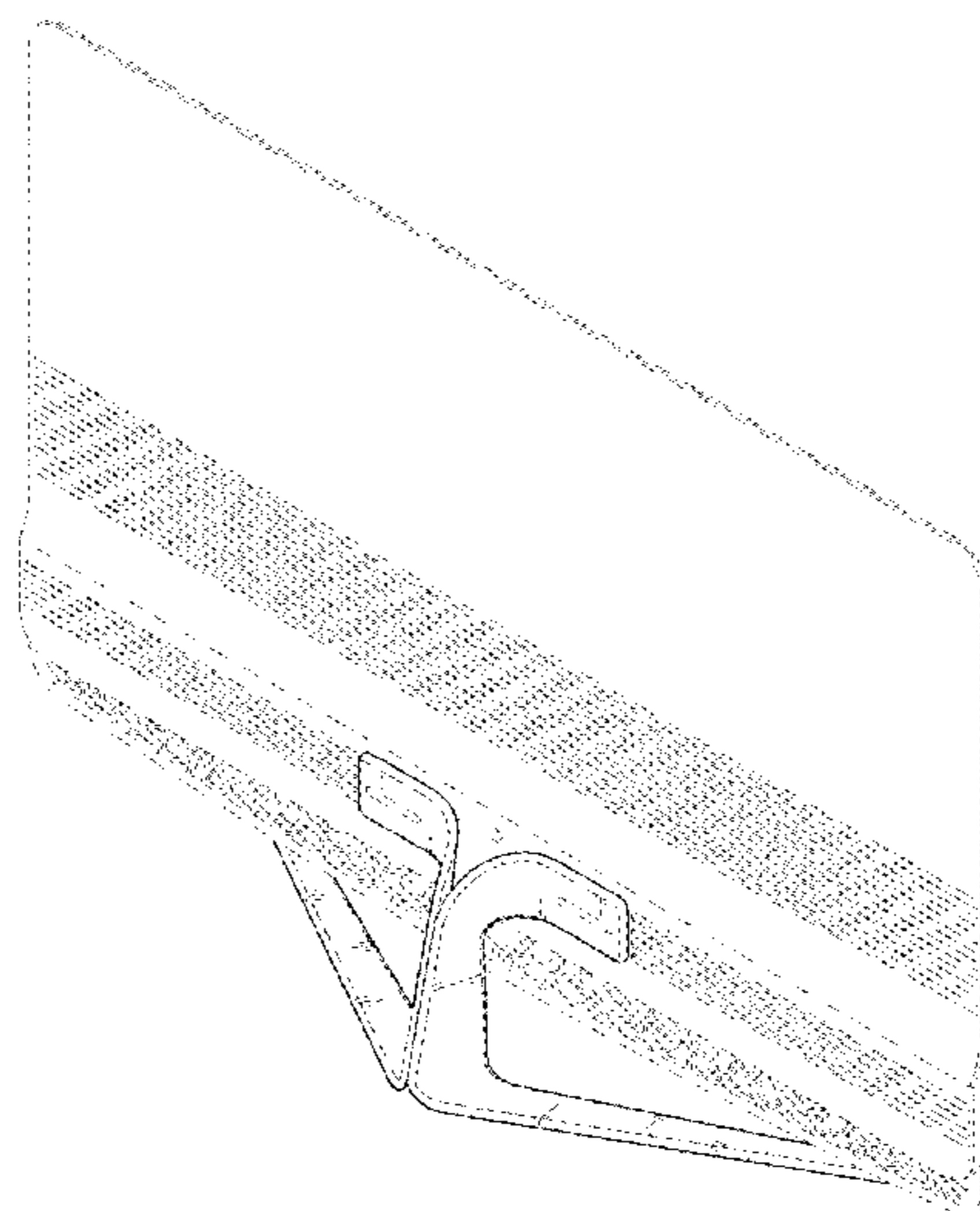

(56)

References Cited

U.S. PATENT DOCUMENTS

D622,234 S *	8/2010	Kim	D14/126
D634,324 S *	3/2011	Park	D14/374
D634,721 S *	3/2011	Baek	D14/126
D647,909 S *	11/2011	Chou	D14/450
D661,273 S *	6/2012	Chu	D14/126
D669,047 S *	10/2012	Asanuma	D14/126
D674,762 S *	1/2013	Lee	D14/126
D675,175 S *	1/2013	Kim	D14/126
D680,508 S *	4/2013	Kim	D14/126
D682,227 S *	5/2013	Lee	D14/126
D686,615 S *	7/2013	Lee	D14/374
D712,856 S *	9/2014	Thompson	D14/126
D717,754 S *	11/2014	Kim	D14/126
D762,625 S *	8/2016	Yoo	D14/126

* cited by examiner

FIG. 1

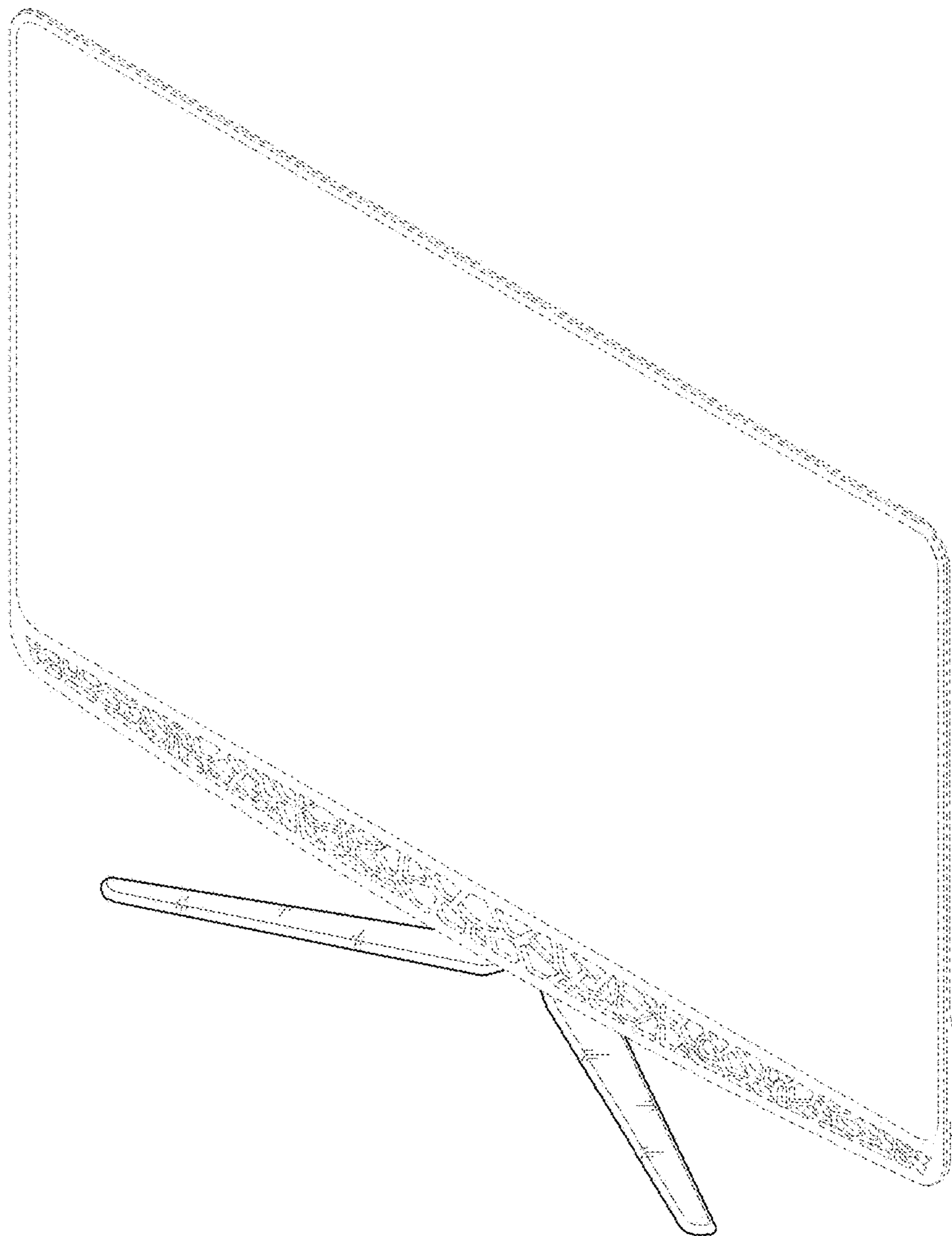

FIG. 2

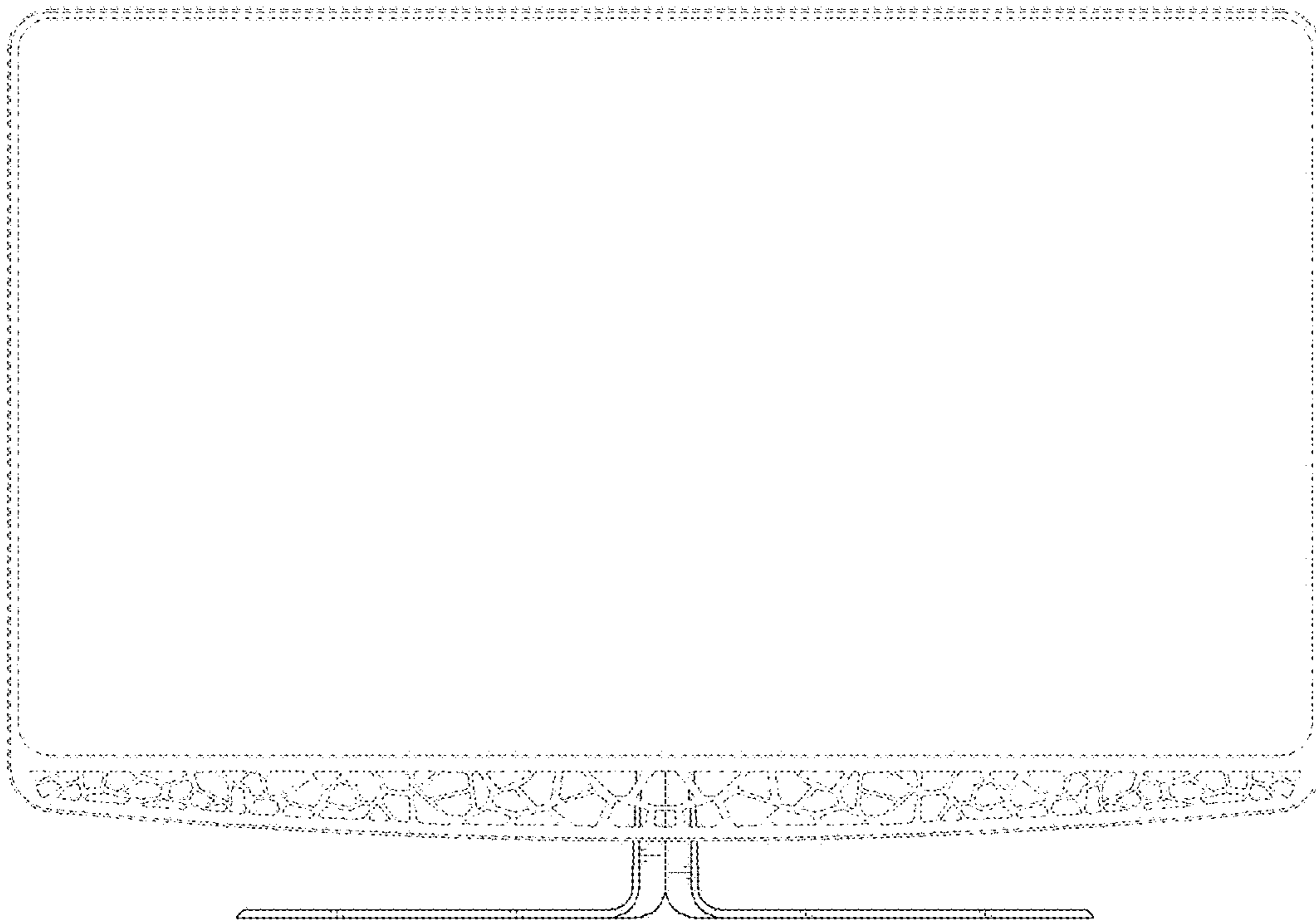

FIG. 3

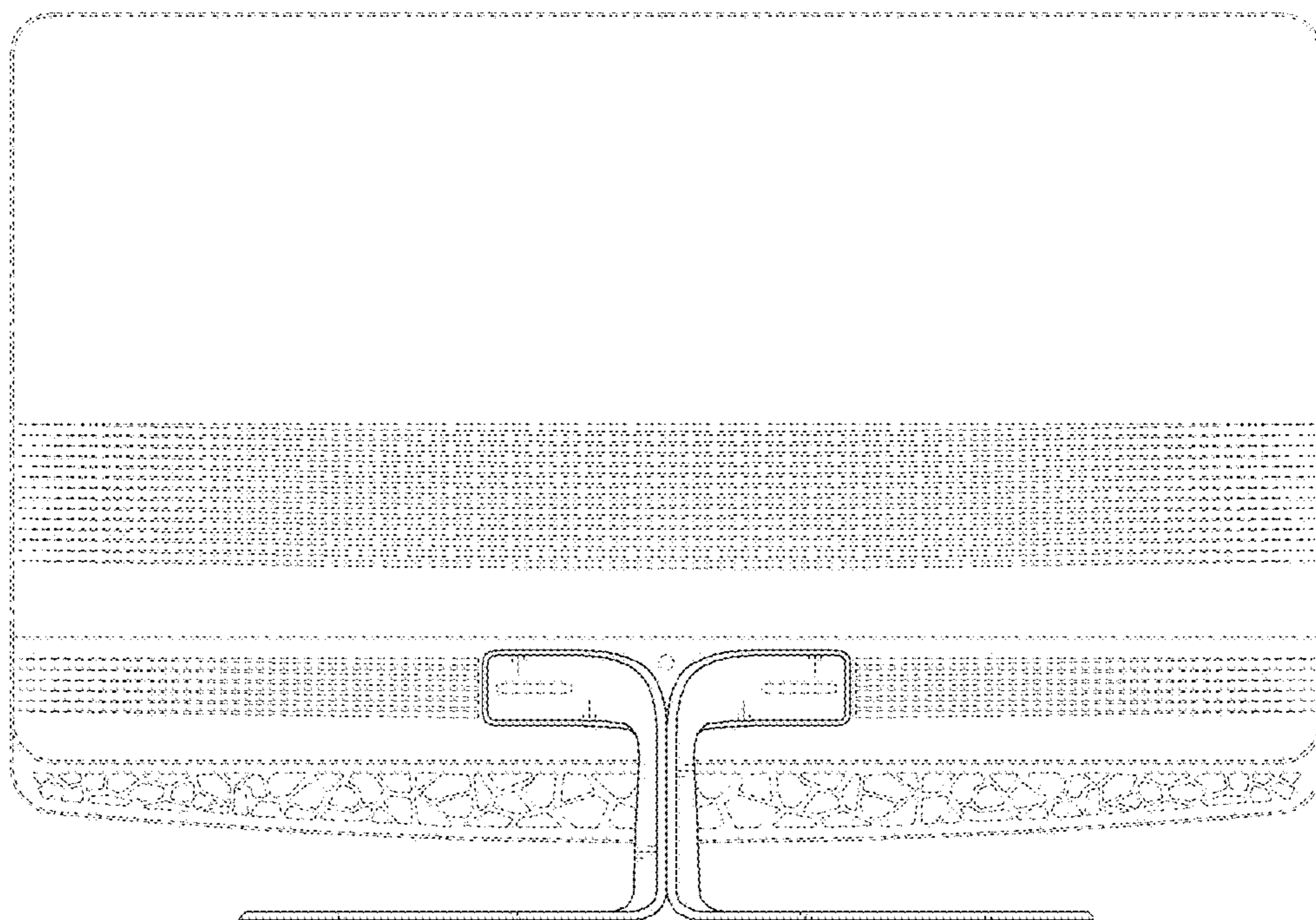

FIG. 4

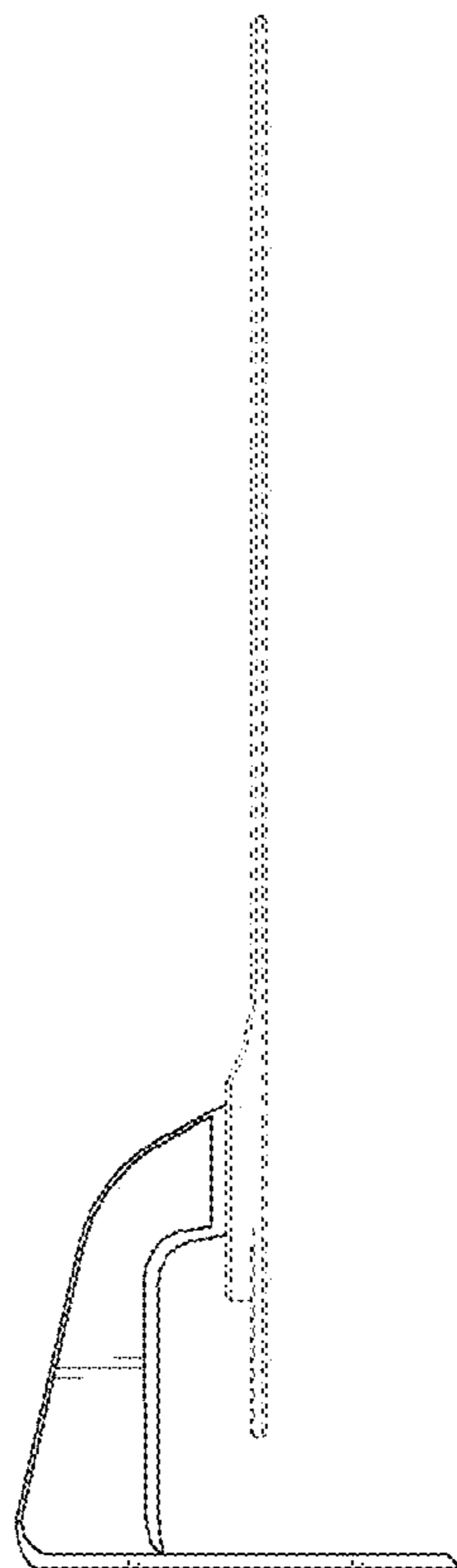

FIG. 5

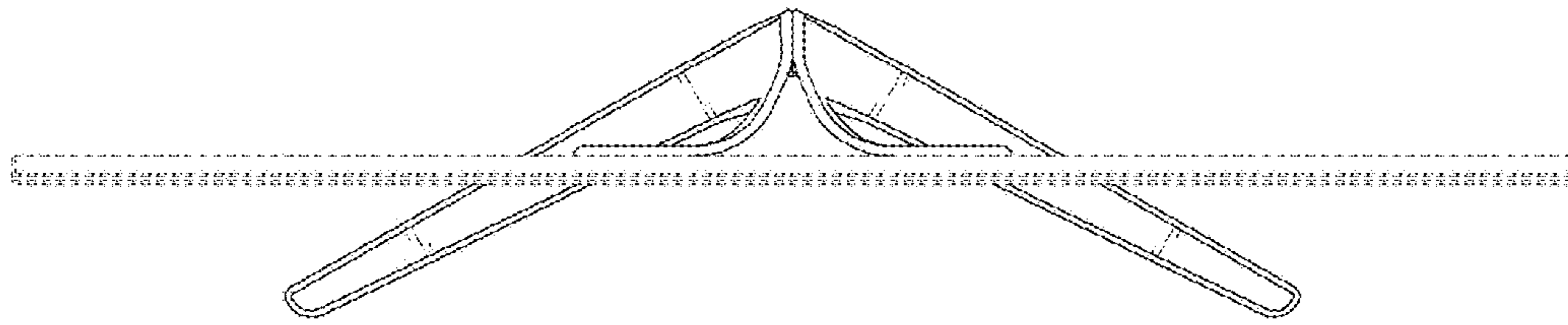

FIG. 6

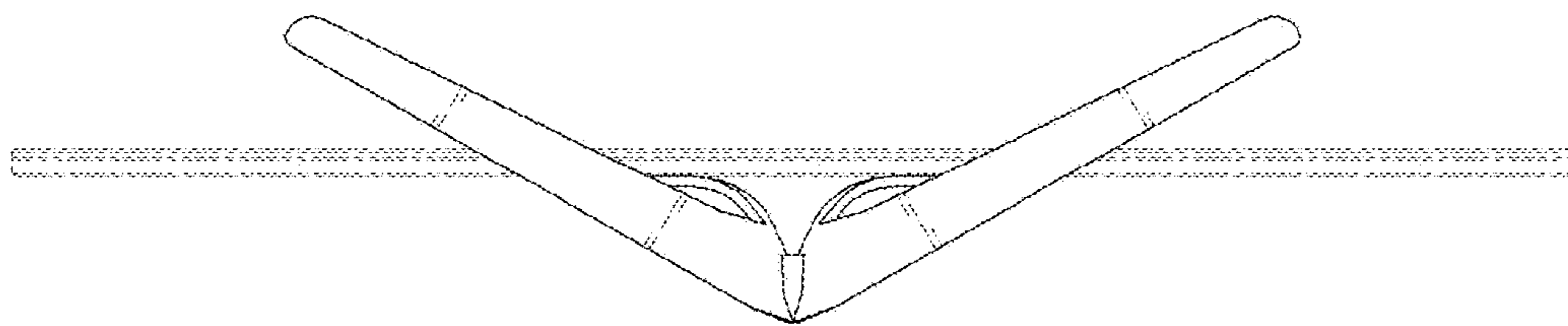

FIG. 7

