



US00D781233S

(12) **United States Design Patent** (10) **Patent No.:** **US D781,233 S**
Visel et al. (45) **Date of Patent:** **** *Mar. 14, 2017**

(54) **HOUSING FOR ELECTRIC AND ELECTRONIC COMPONENTS**

(71) Applicant: **Robert Bosch GmbH**, Stuttgart (DE)

(72) Inventors: **Benjamin Visel**, Bad Liebenzell-Moettlingen (DE); **Janina Zeller**, Leinfelden-Echterdingen (DE); **Vincent Hasenmayer**, Stuttgart-Möhringen (DE); **Christian Haupt**, Stuttgart (DE)

(73) Assignee: **Robert Bosch GmbH**, Stuttgart (DE)

(*) Notice: This patent is subject to a terminal disclaimer.

(**) Term: **15 Years**

(21) Appl. No.: **29/540,634**

(22) Filed: **Sep. 25, 2015**

(30) **Foreign Application Priority Data**

Mar. 27, 2015 (EM) 002670745

(51) **LOC (10) Cl.** **13-03**

(52) **U.S. Cl.**
USPC **D13/133; D13/184**

(58) **Field of Classification Search**
USPC D13/101, 103, 110, 118, 123, 133, 154,
D13/156, 158, 160, 162, 173, 184, 199;
D15/28

(Continued)

(56) **References Cited**

U.S. PATENT DOCUMENTS

D627,800 S * 11/2010 Berning D15/28
D710,398 S * 8/2014 Oeder D15/28

(Continued)

Primary Examiner — Thomas Johannes
Assistant Examiner — Shawn T Gingrich

(74) *Attorney, Agent, or Firm* — Maginot, Moore & Beck LLP

(57) **CLAIM**

The ornamental design for a housing for electric and electronic components, as shown and described.

DESCRIPTION

The file of this patent contains at least one drawing executed in color. Copies of this patent with color drawings will be provided by the Office upon request and payment of the necessary fee.

Cross reference is made to copending U.S. design patent application Ser. No. 29/540,635 entitled “housing for electric and electronic components” by Visel et al., filed on even date herewith; U.S. design patent application Ser. No. 29/540,639 entitled “housing for electric and electronic components” by Visel et al., filed on even date herewith; and U.S. design patent application Ser. No. 29/540,647 entitled “housing for electric and electronic components” by Visel et al., filed on even date herewith.

FIG. 1 is a perspective view of a first embodiment of a housing for electric and electronic components showing our new design;

FIG. 2 is a front elevational view showing the design for the housing for electric and electronic components of FIG. 1; FIG. 3 is a rear elevational view showing the design for the housing for electric and electronic components of FIG. 1; FIG. 4 is a right side elevational view showing the design for the housing for electric and electronic components of FIG. 1;

FIG. 5 is a left side elevational view showing the design for the housing for electric and electronic components of FIG. 1;

FIG. 6 is a top plan view showing the design for the housing for electric and electronic components of FIG. 1; and FIG. 7 is a bottom plan view showing the design for the housing for electric and electronic components of FIG. 1.

FIG. 8 is a perspective view of a second embodiment of a housing for electric and electronic components showing our new design;

FIG. 9 is a front elevational view showing the design for the housing for electric and electronic components of FIG. 8;

(Continued)

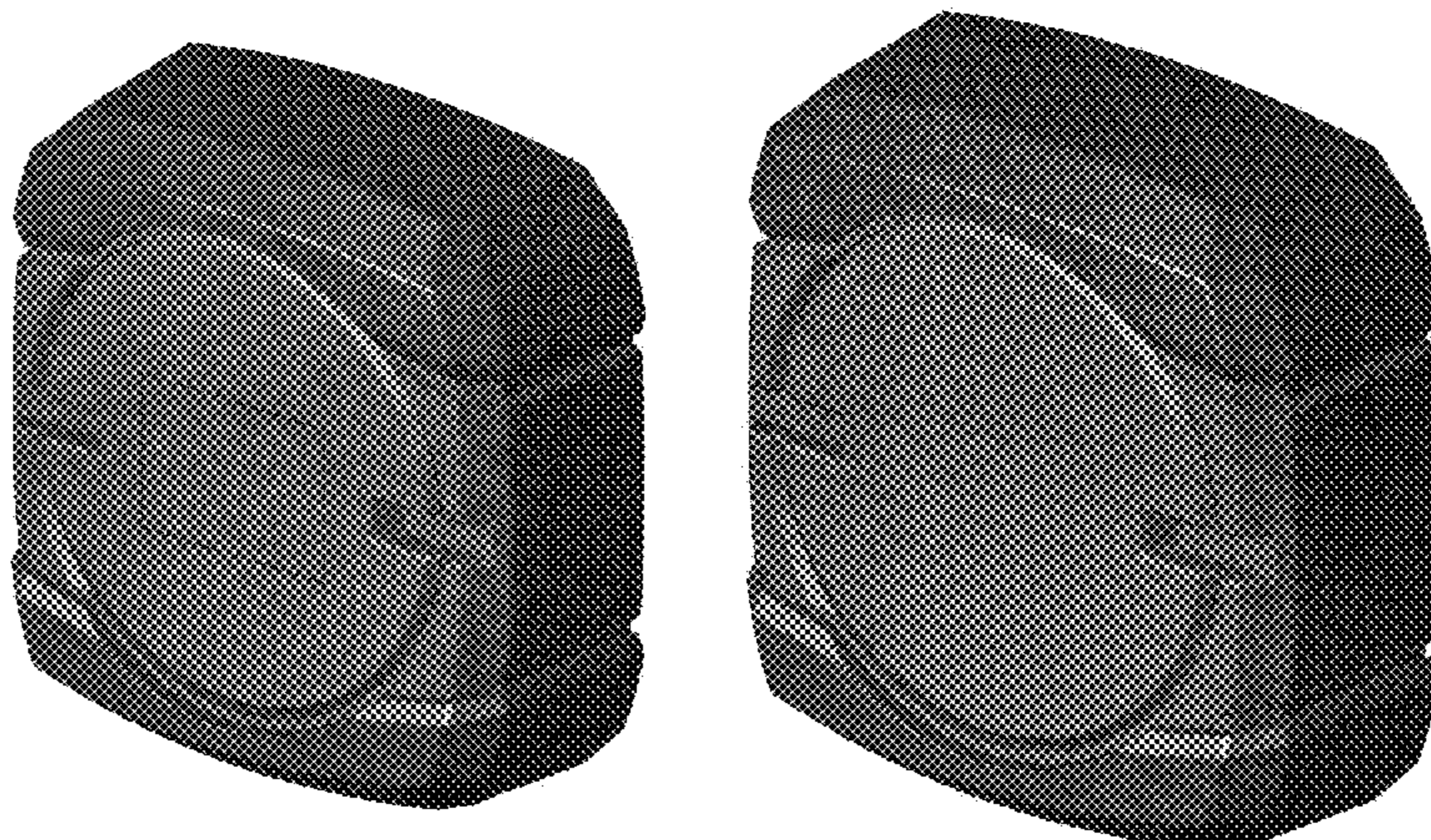

FIG. 10 is a rear elevational view showing the design for the housing for electric and electronic components of FIG. 8; FIG. 11 is a right side elevational view showing the design for the housing for electric and electronic components of FIG. 8; FIG. 12 is a left side elevational view showing the design for the housing for electric and electronic components of FIG. 8; FIG. 13 is a top plan view showing the design for the housing for electric and electronic components of FIG. 8; and, FIG. 14 is a bottom plan view showing the design for the housing for electric and electronic components of FIG. 8. The broken lines shown in the figures illustrate portions of the housing for electric and electronic components that form no part of the claimed design.

1 Claim, 14 Drawing Sheets
(14 of 14 Drawing Sheet(s) Filed in Color)

(58) **Field of Classification Search**

CPC F21V 19/00; F23N 5/20; G08C 19/16; G08B 1/08; H01L 27/15; H01J 1/00; H01J 1/62; H01R 13/51; H01R 13/62; H01R 13/64; H01R 24/00; H02G 3/04; H02G 3/08; H05K 5/00; H05K 7/14; H05K 7/20
See application file for complete search history.

(56) **References Cited**

U.S. PATENT DOCUMENTS

D710,400	S	*	8/2014	Oeder	D15/28
D722,983	S	*	2/2015	Paredes	D13/168
D724,462	S	*	3/2015	Bould	D10/106.2
D725,049	S	*	3/2015	Paredes	D13/168
D746,711	S	*	1/2016	Li	D10/106.1
D748,294	S	*	1/2016	Tauterer	D26/1
D751,515	S	*	3/2016	Paredes	D13/168
D759,012	S	*	6/2016	Golden	D10/50
2013/0063259	A1	*	3/2013	Kramer	G08C 17/02 340/539.11

* cited by examiner

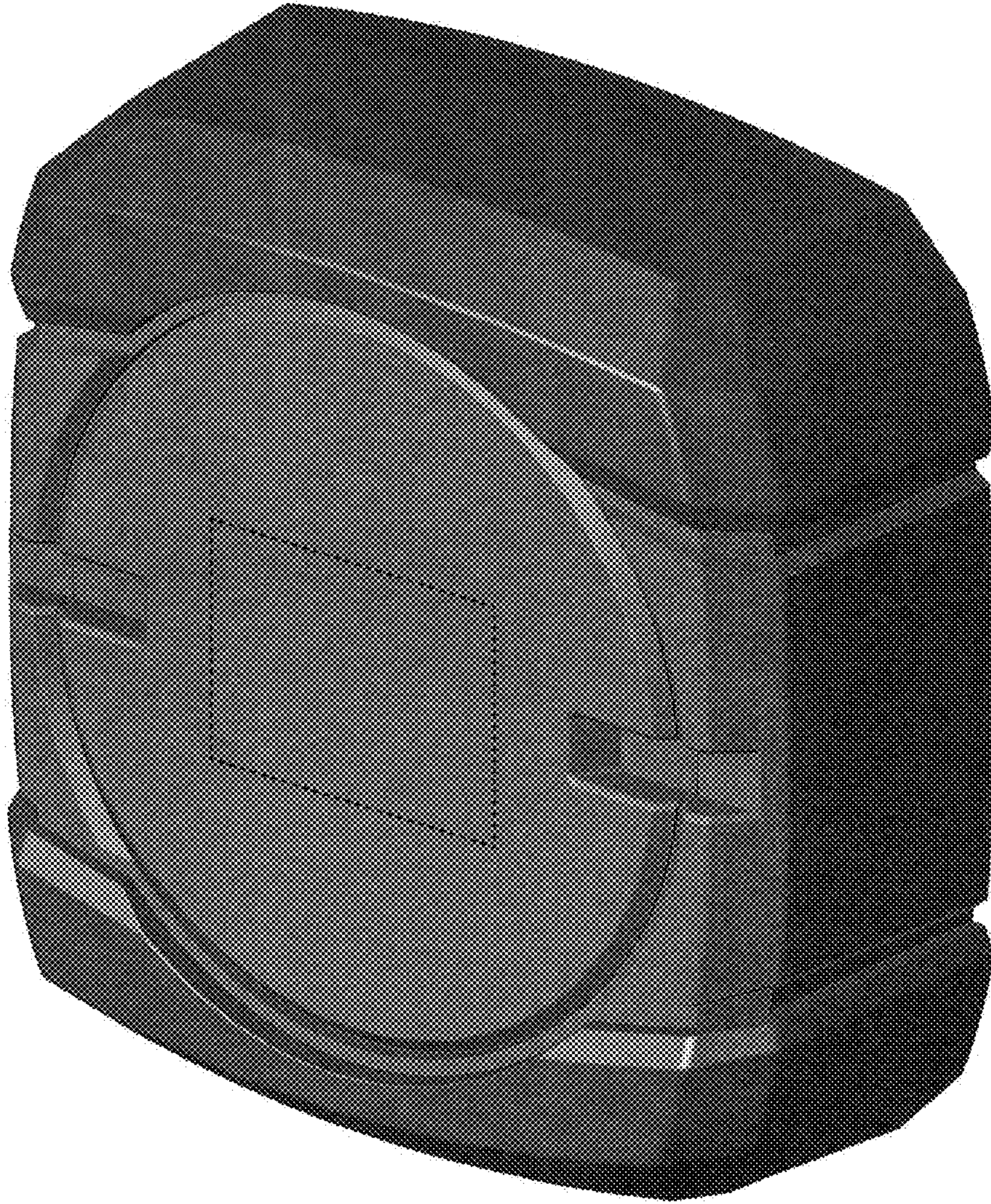

FIG. 1

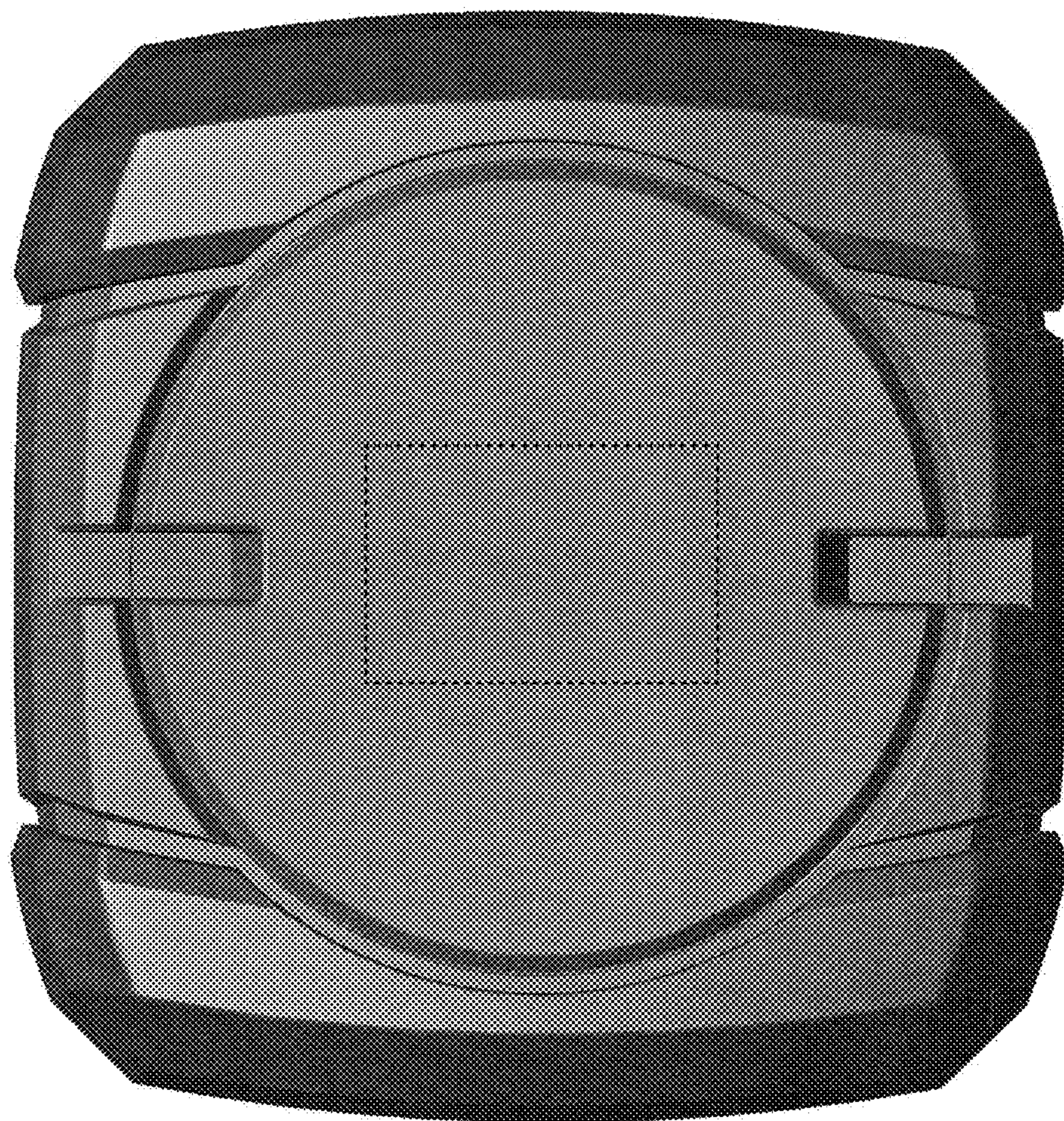

FIG. 2

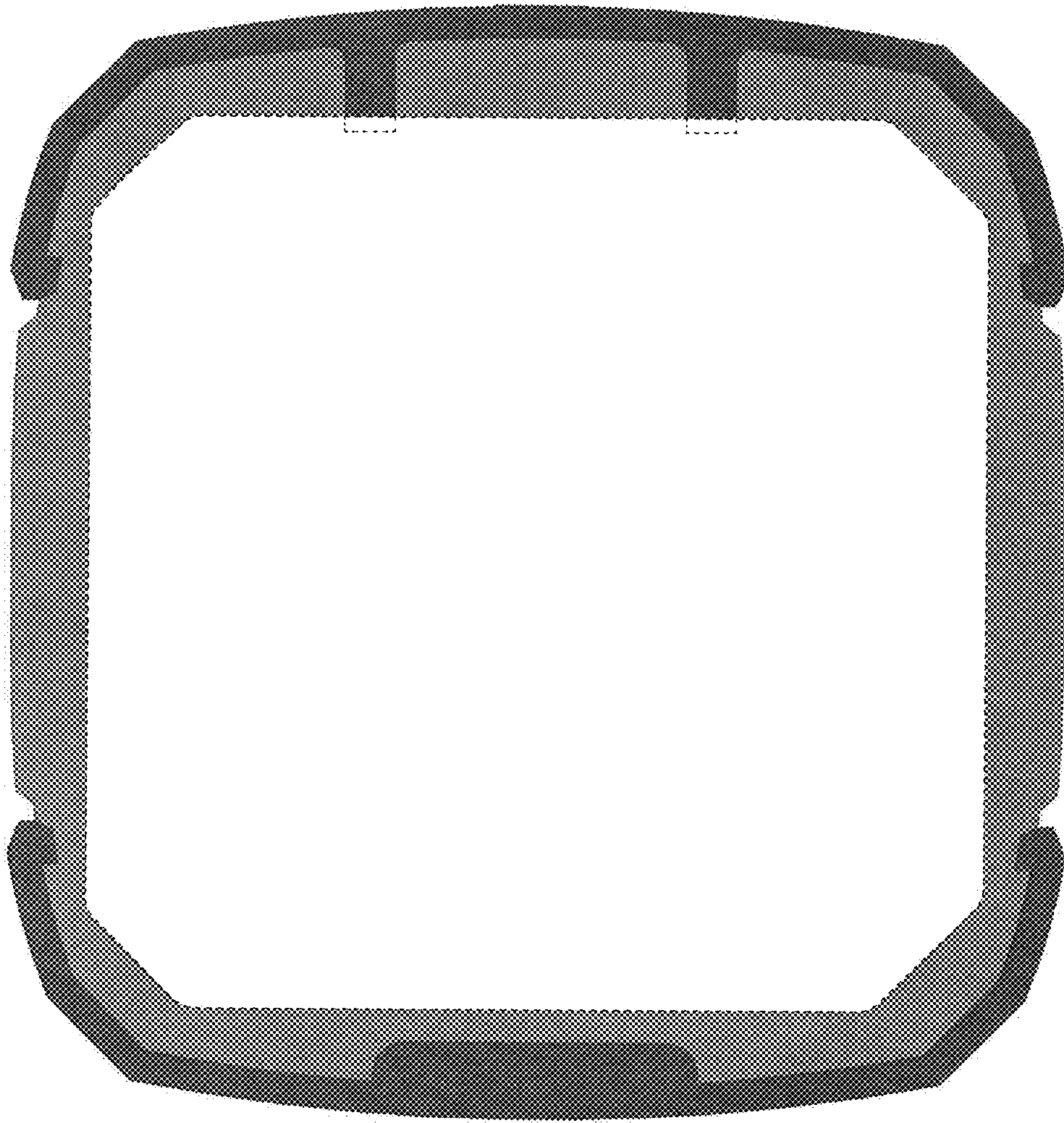

FIG. 3

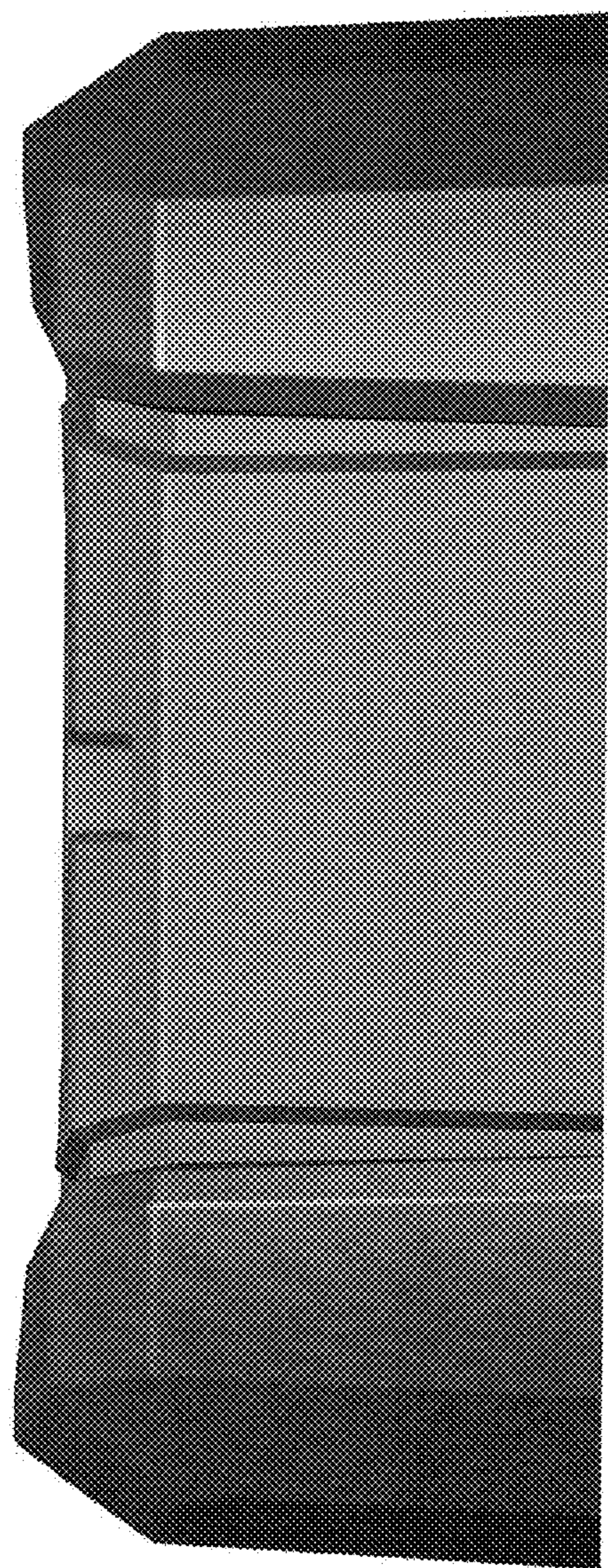

FIG. 4

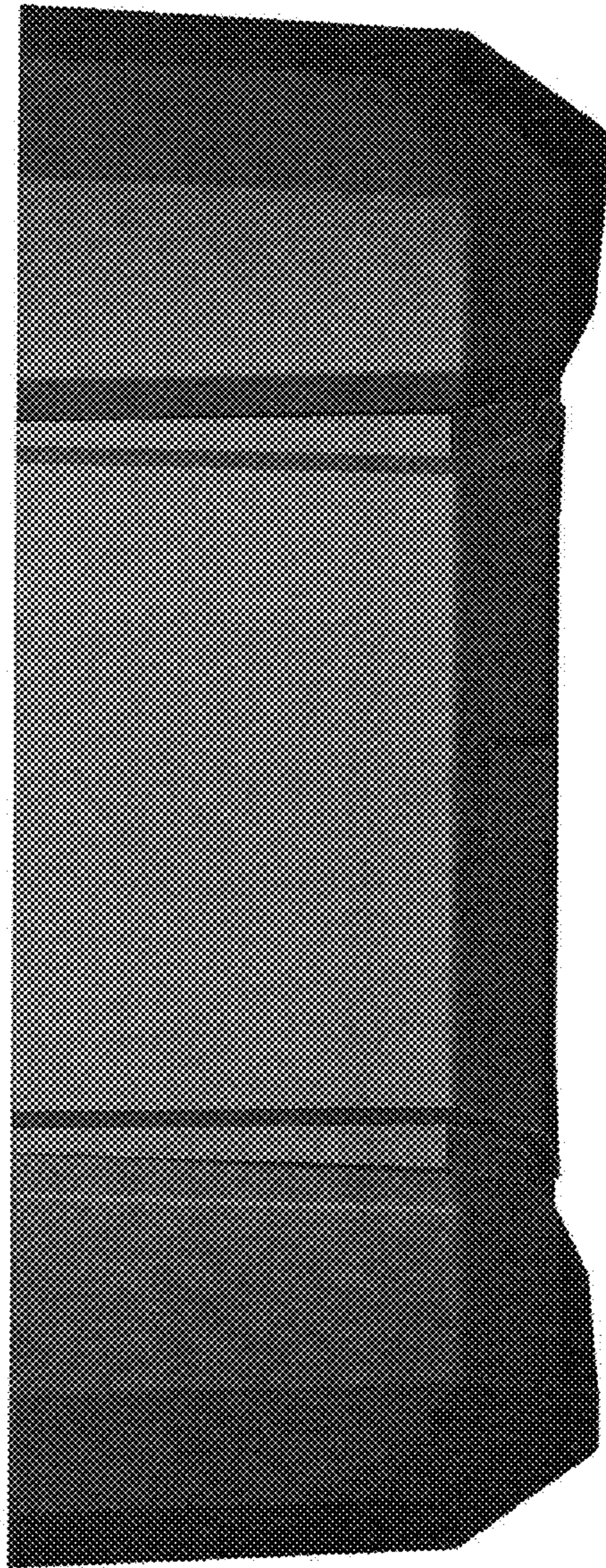

FIG. 5

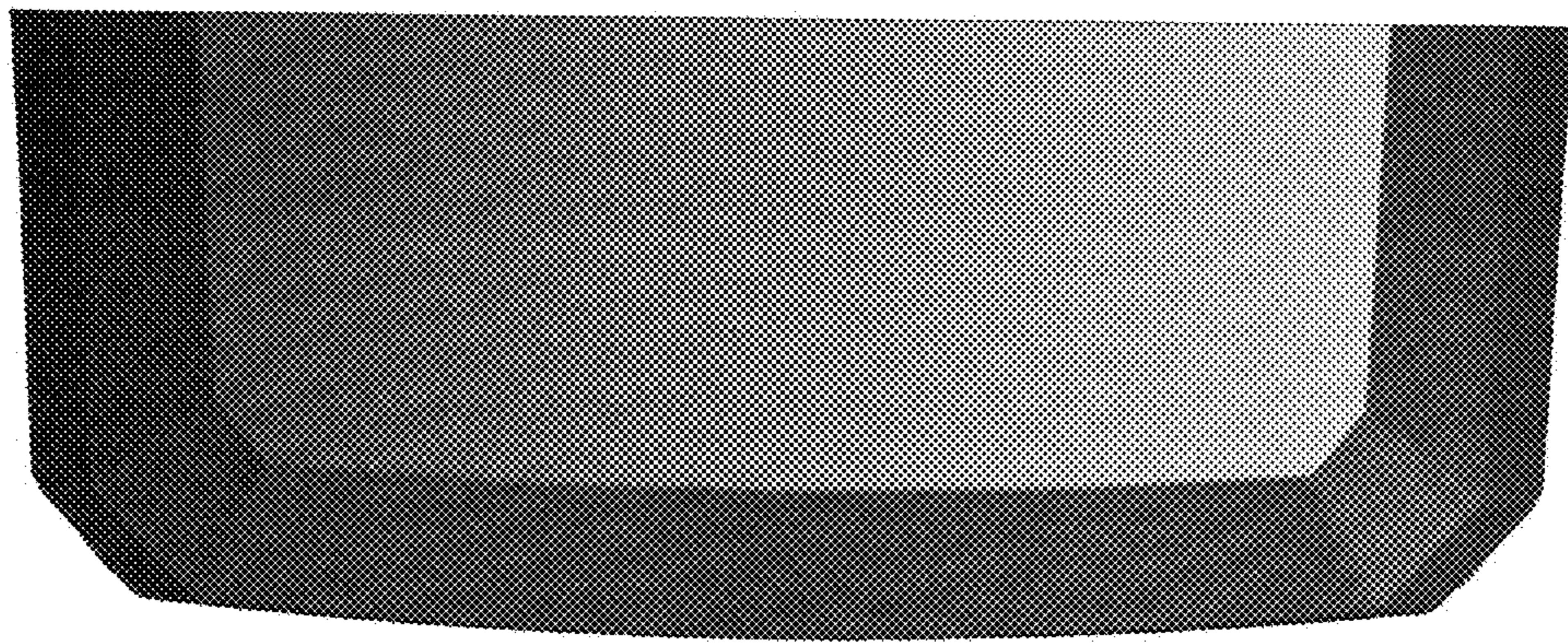

FIG. 6

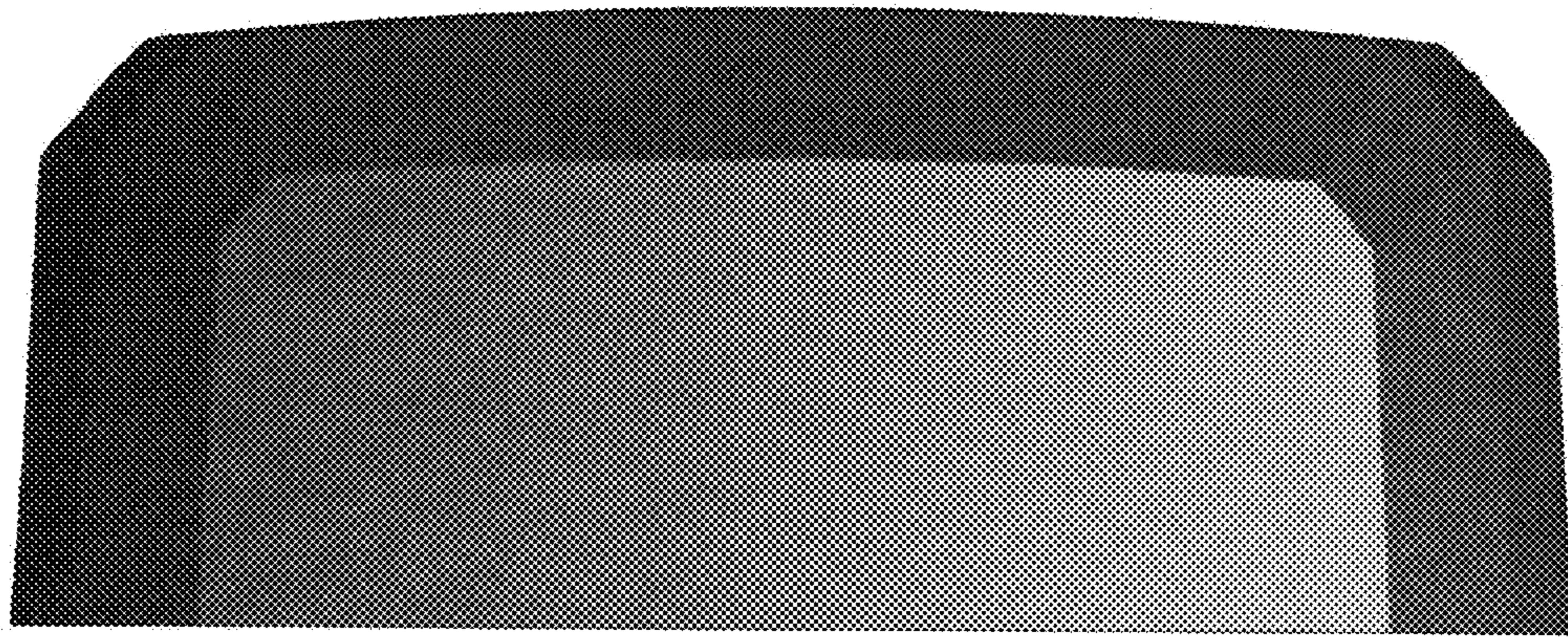

FIG. 7

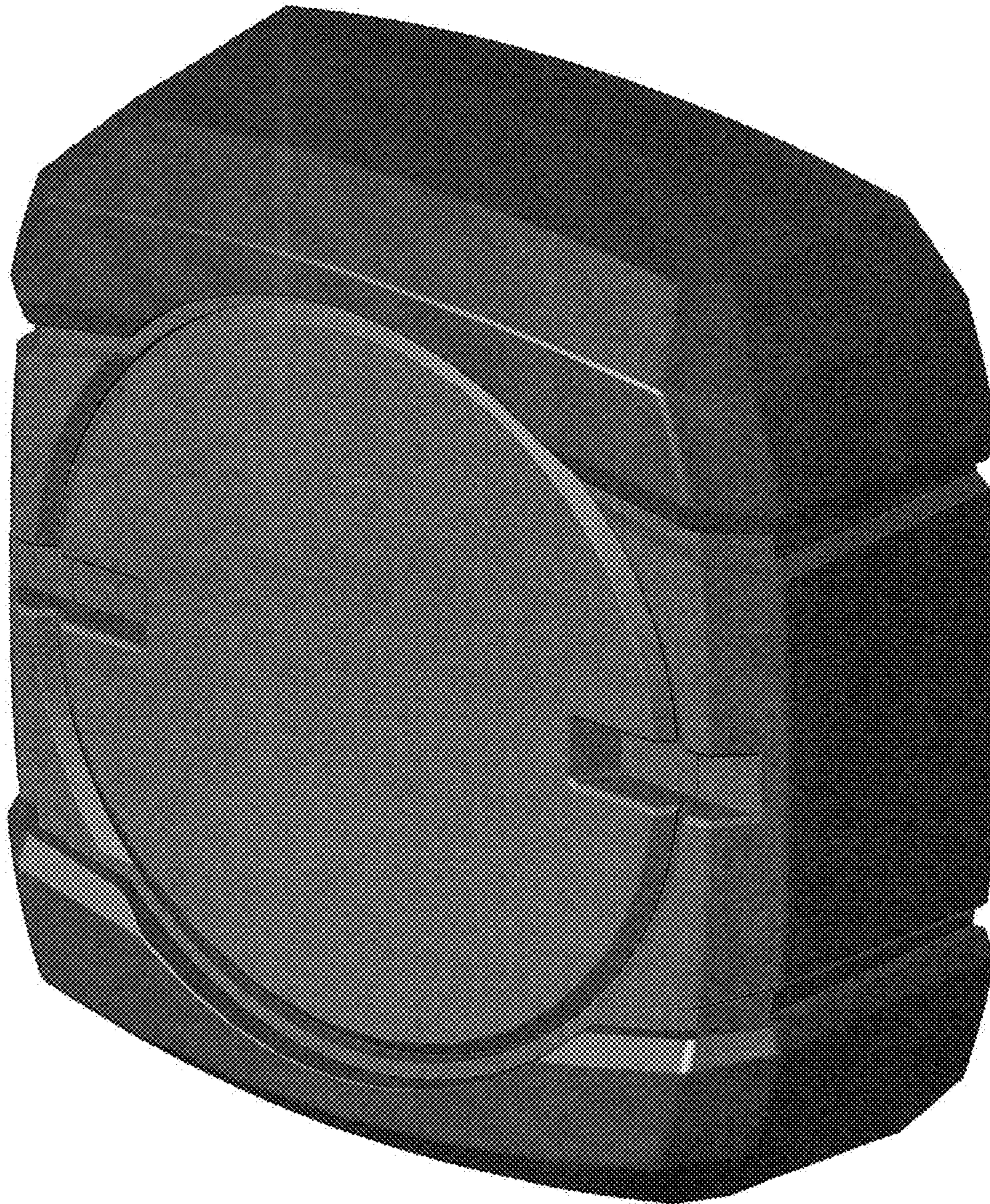

FIG. 8

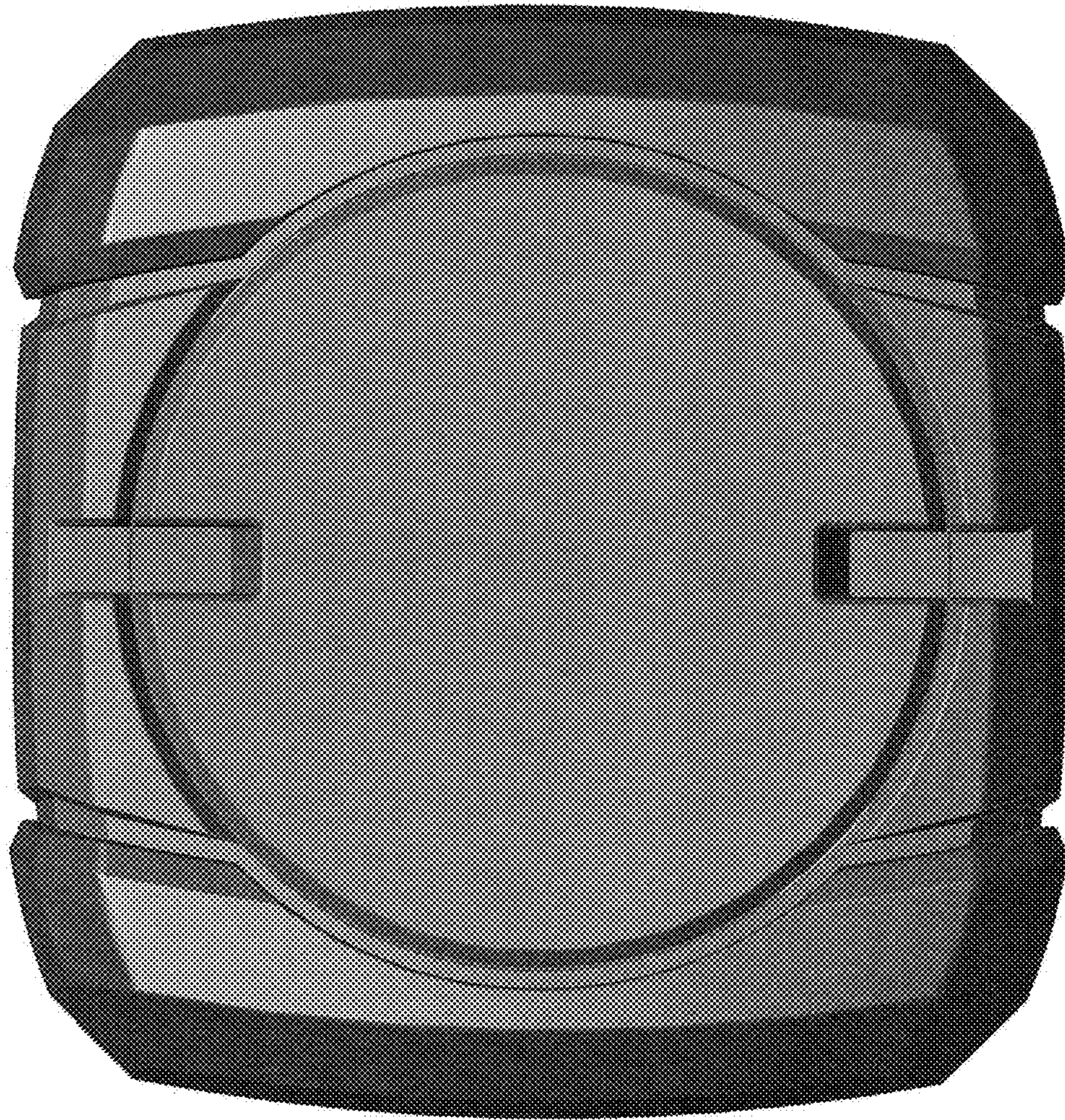

FIG. 9

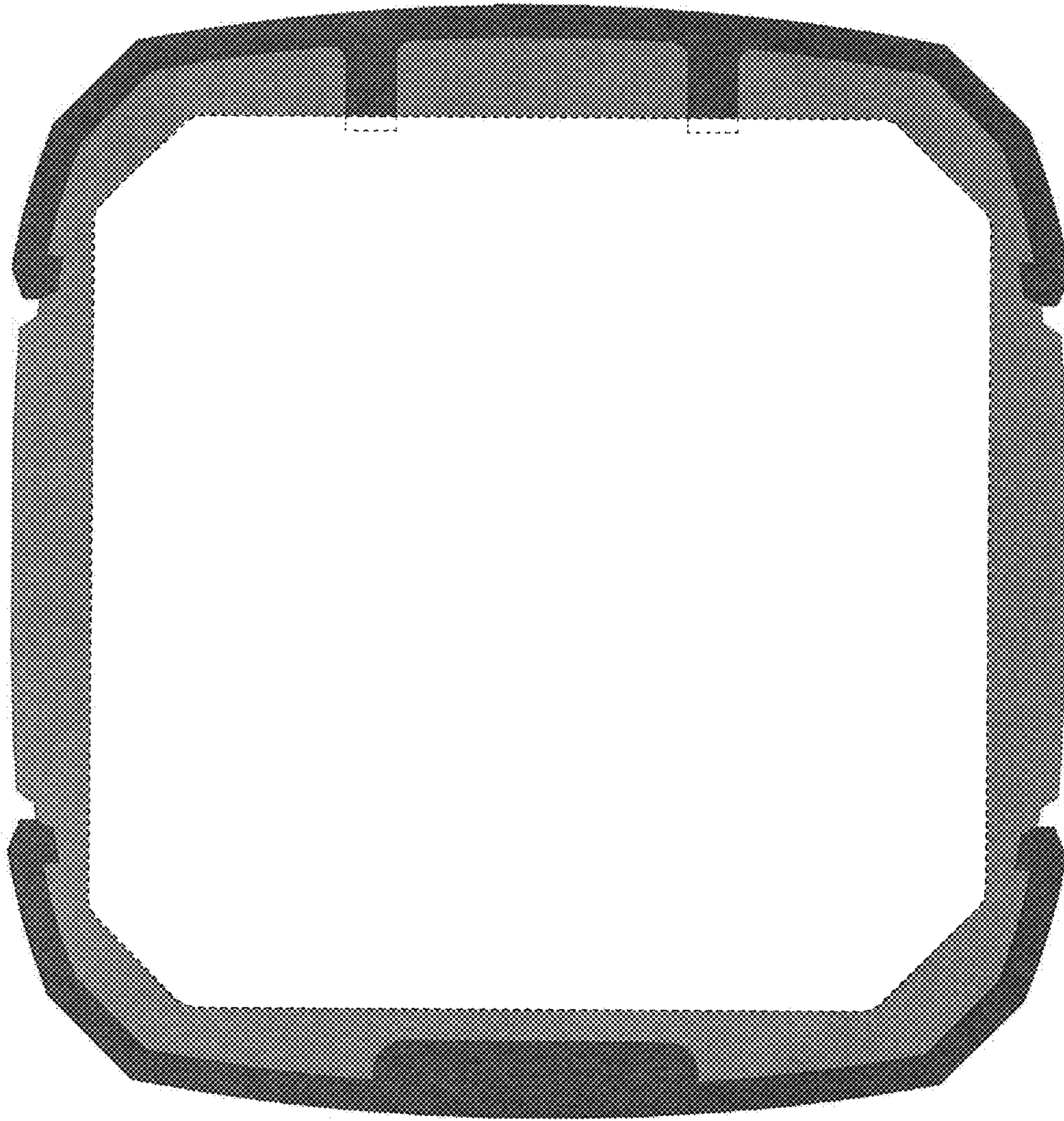

FIG. 10

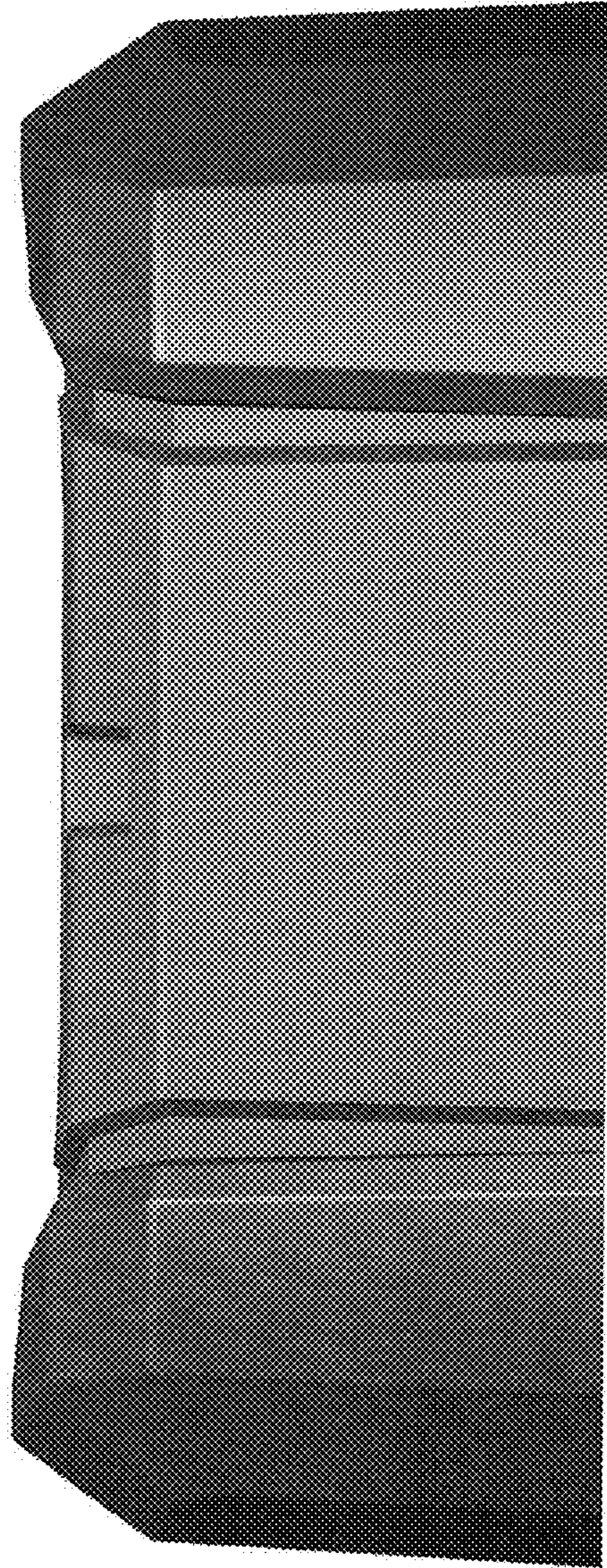

FIG. 11

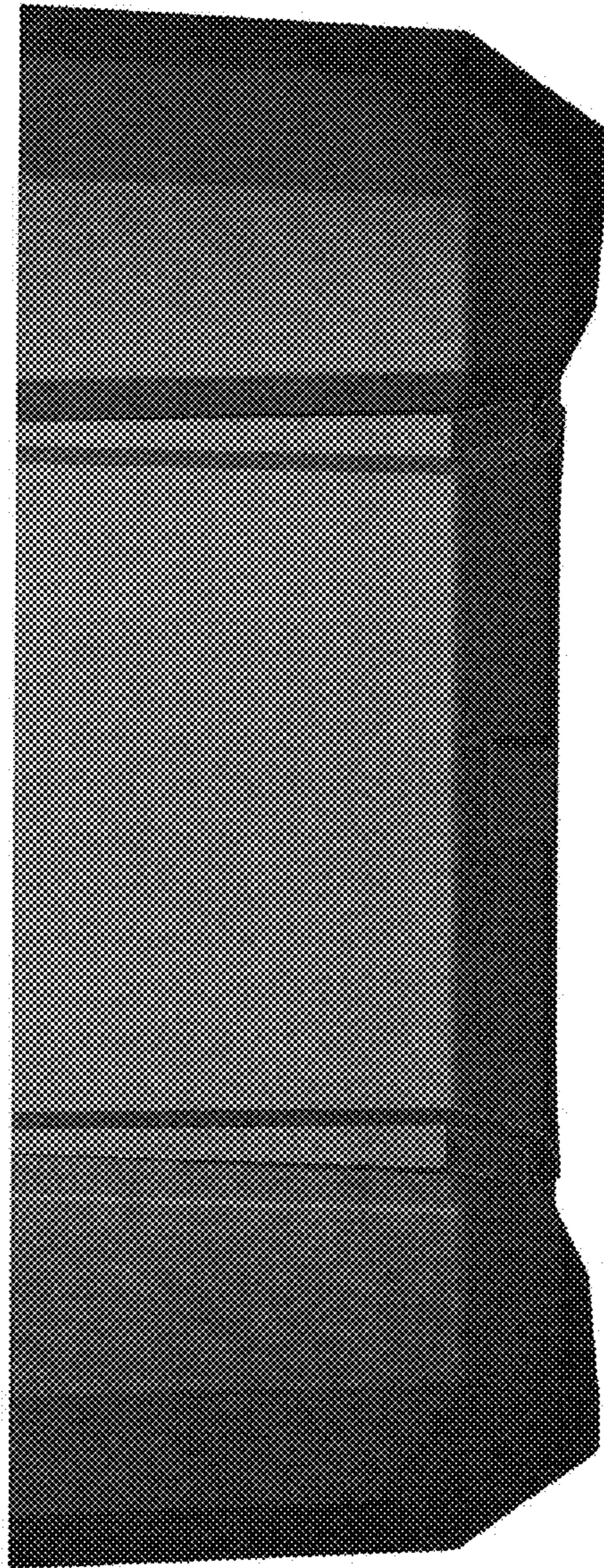

FIG. 12

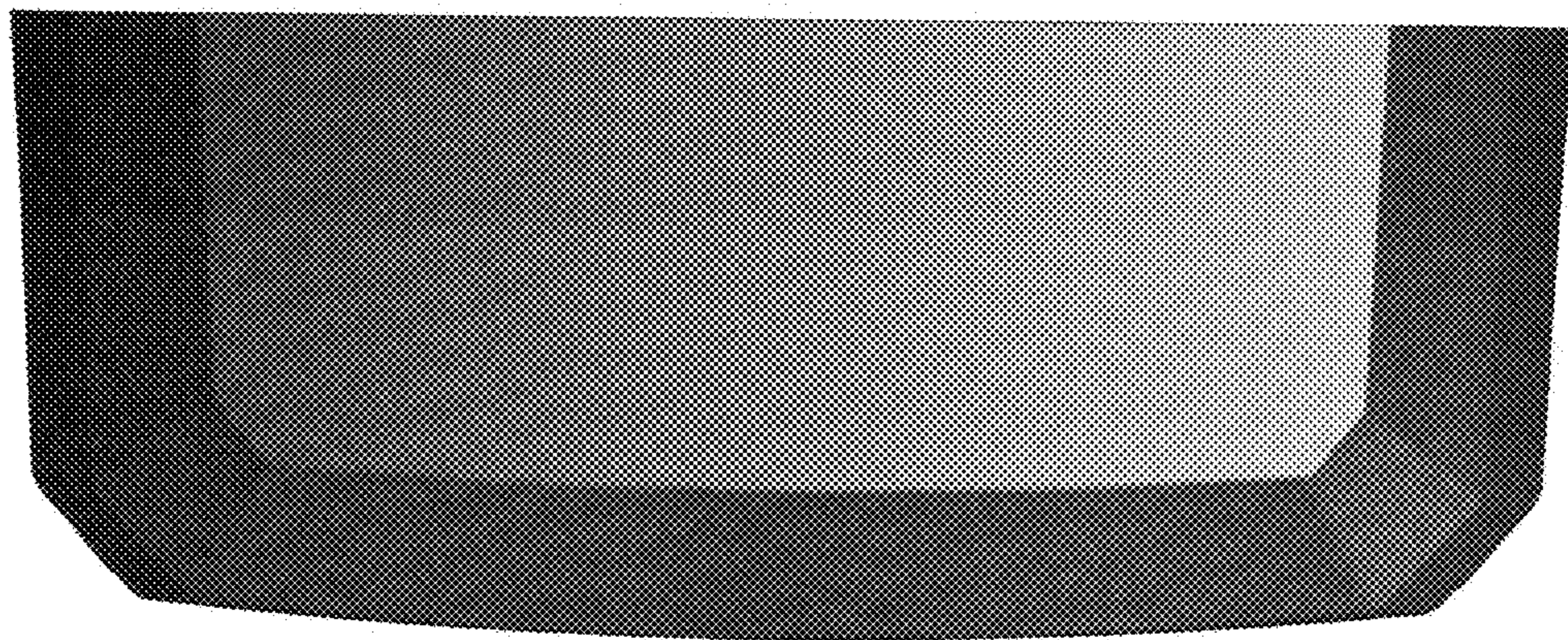

FIG. 13

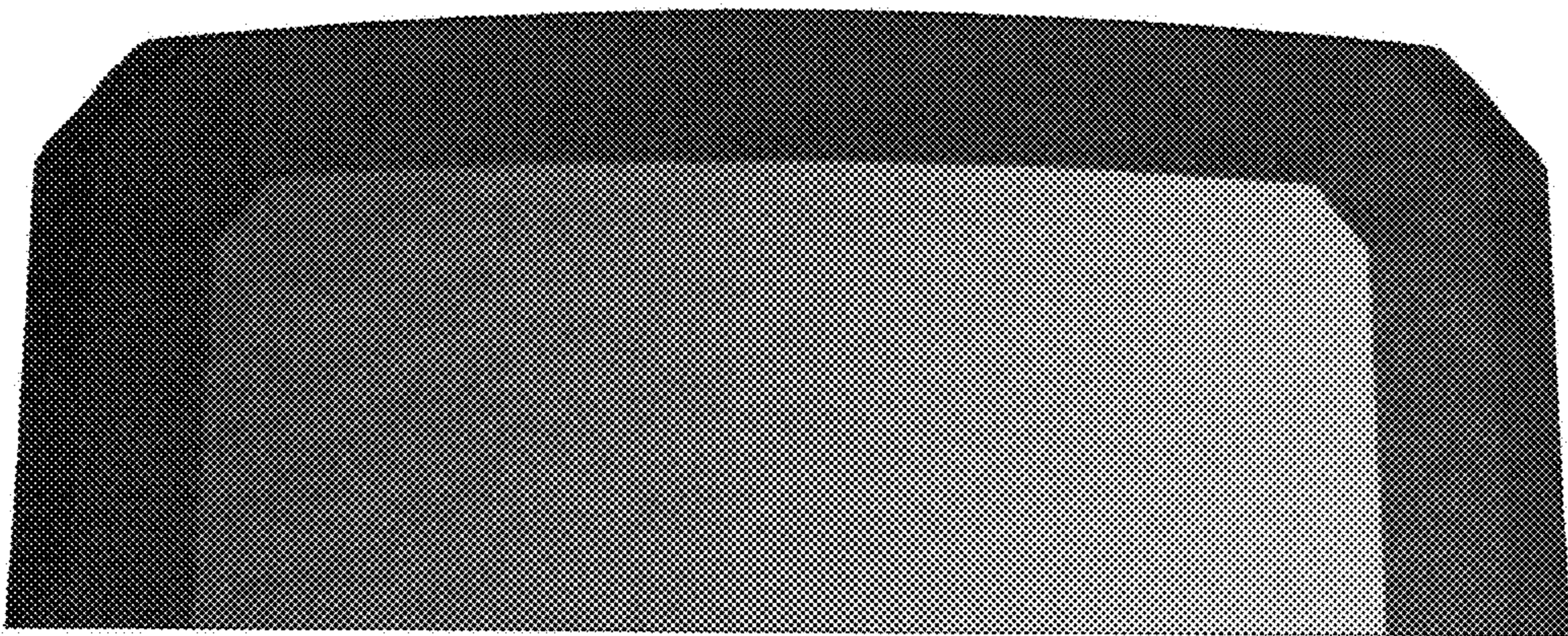

FIG. 14