



US00D781142S

(12) **United States Design Patent**  
**Trujillo**

(10) **Patent No.:** **US D781,142 S**  
(45) **Date of Patent:** **\*\* \*Mar. 14, 2017**

(54) **BEVERAGE CONTAINER**

(71) Applicant: **Tequila Mixology**, West Covina, CA (US)  
(72) Inventor: **Guillermina Trujillo**, West Covina, CA (US)  
(73) Assignee: **TEQUILA MIXOLOGY**, West Covina, CA (US)

(\*) Notice: This patent is subject to a terminal disclaimer.

(\*\*) Term: **15 Years**

(21) Appl. No.: **29/533,668**

(22) Filed: **Jul. 20, 2015**

(51) **LOC (10) Cl.** ..... **09-03**

(52) **U.S. Cl.**  
USPC ..... **D9/432**

(58) **Field of Classification Search**  
USPC ..... D9/430, 414, 432, 524, 516, 433, 431;  
D7/543, 545, 602, 552.2, 538; 229/112  
CPC ..... B65D 1/00; B65D 5/4291; B65D 5/38;  
A47F 5/11  
See application file for complete search history.

(56) **References Cited**

U.S. PATENT DOCUMENTS

D340,642 S	*	10/1993	Detzel	.....	D9/417
D427,062 S	*	6/2000	Alvarez	.....	D23/211.1
D437,218 S	*	2/2001	Ljunstrom	.....	D9/417
D522,854 S	*	6/2006	Engels	.....	D9/417
D586,221 S	*	2/2009	Shaikh	.....	D9/523
D702,117 S	*	4/2014	Dagnino	.....	D9/417
D717,644 S	*	11/2014	Franic	.....	D9/431
D722,869 S	*	2/2015	Himmelsbach	.....	D9/432

(Continued)

Primary Examiner — Cynthia Underwood

(74) *Attorney, Agent, or Firm* — Loza & Loza, LLP;  
Heidi L. Eisenhut

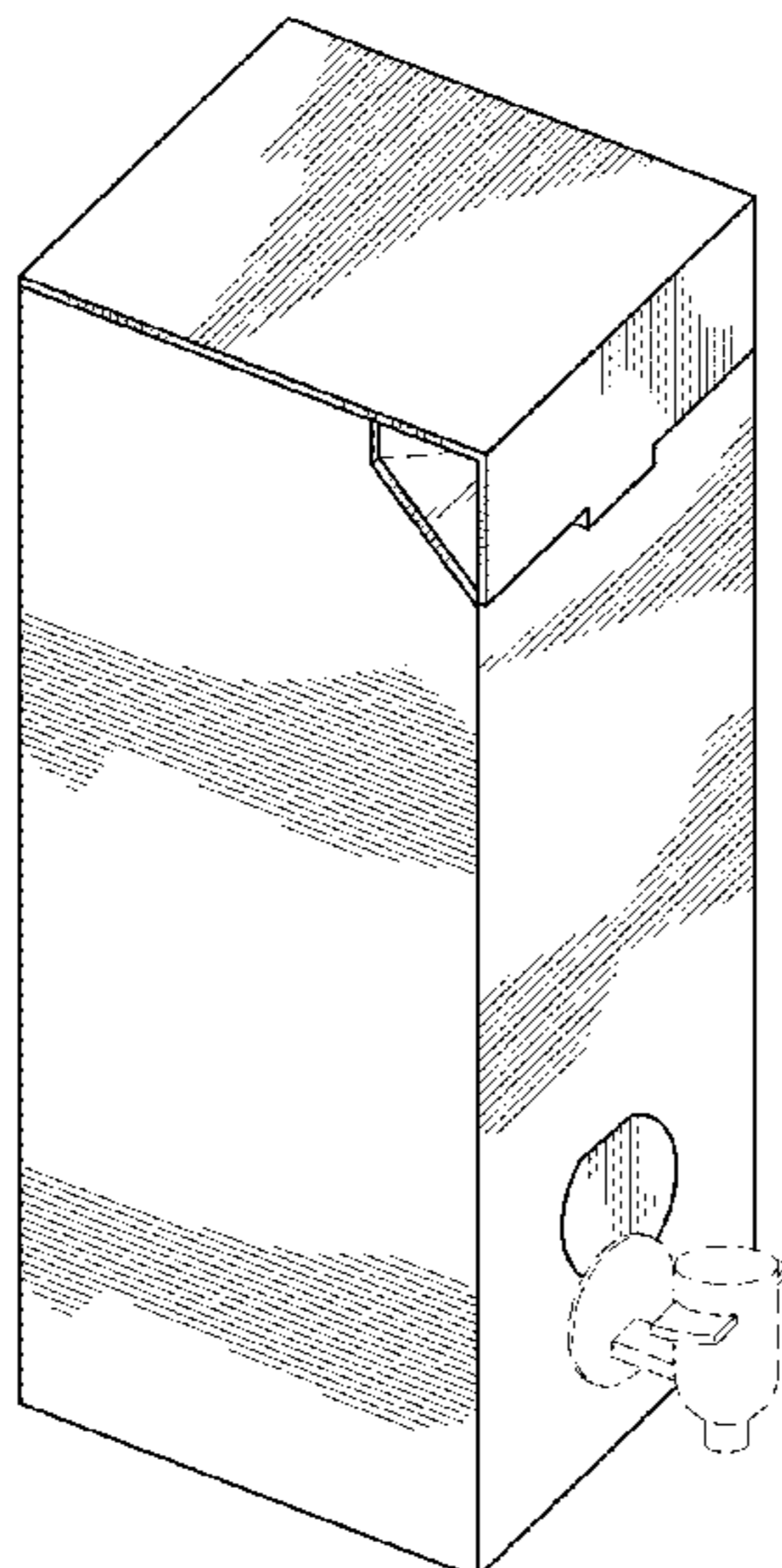
(57) **CLAIM**

The ornamental design of a beverage container, as shown and described.

**DESCRIPTION**

FIG. 1 is a top right perspective view of a beverage container in a closed position of the present invention;  
FIG. 2 is a right side elevation view of the beverage container of FIG. 1;  
FIG. 3 is a left side elevation view of the beverage container of FIG. 1;  
FIG. 4 is a front elevation view of the beverage container of FIG. 1;  
FIG. 5 is a back elevation view of the beverage container of FIG. 1;  
FIG. 6 is a top plan view of the beverage container of FIG. 1;  
FIG. 7 is a bottom plan view of the beverage container of FIG. 1;  
FIG. 8 is a top right perspective view of the beverage container of FIG. 1 in an open position;  
FIG. 9 is a right side elevation view of the beverage container of FIG. 8;  
FIG. 10 is a left side elevation view of the beverage container of FIG. 8;  
FIG. 11 is a front elevation view of the beverage container of FIG. 8;  
FIG. 12 is a back elevation view of the beverage container of FIG. 8;  
FIG. 13 is a top plan view of the beverage container of FIG. 8; and,  
FIG. 14 is a bottom plan view of the beverage container of FIG. 8.  
The broken lines represent environment that forms no part of the claim.

**1 Claim, 9 Drawing Sheets**



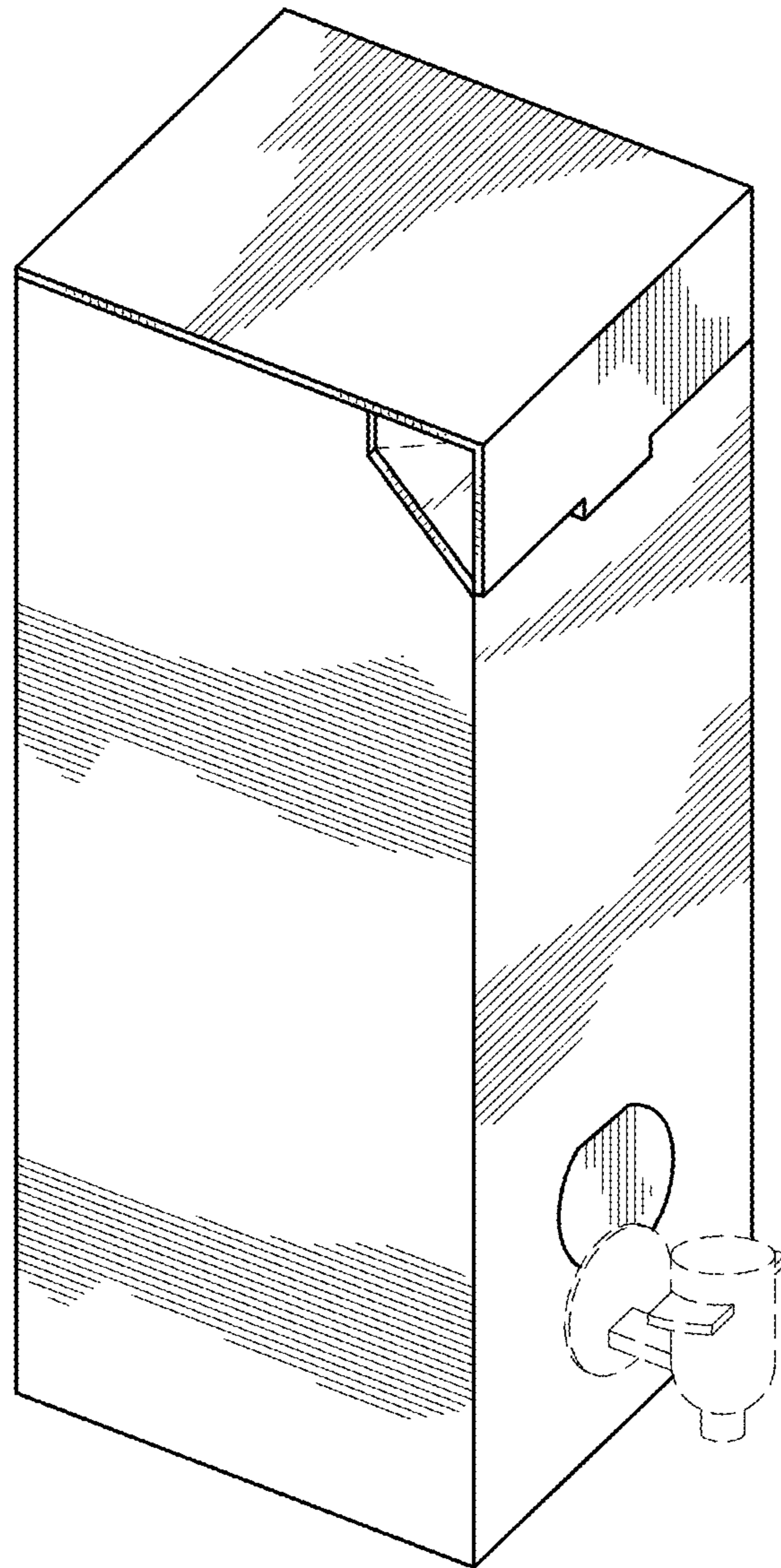
(56)

**References Cited**

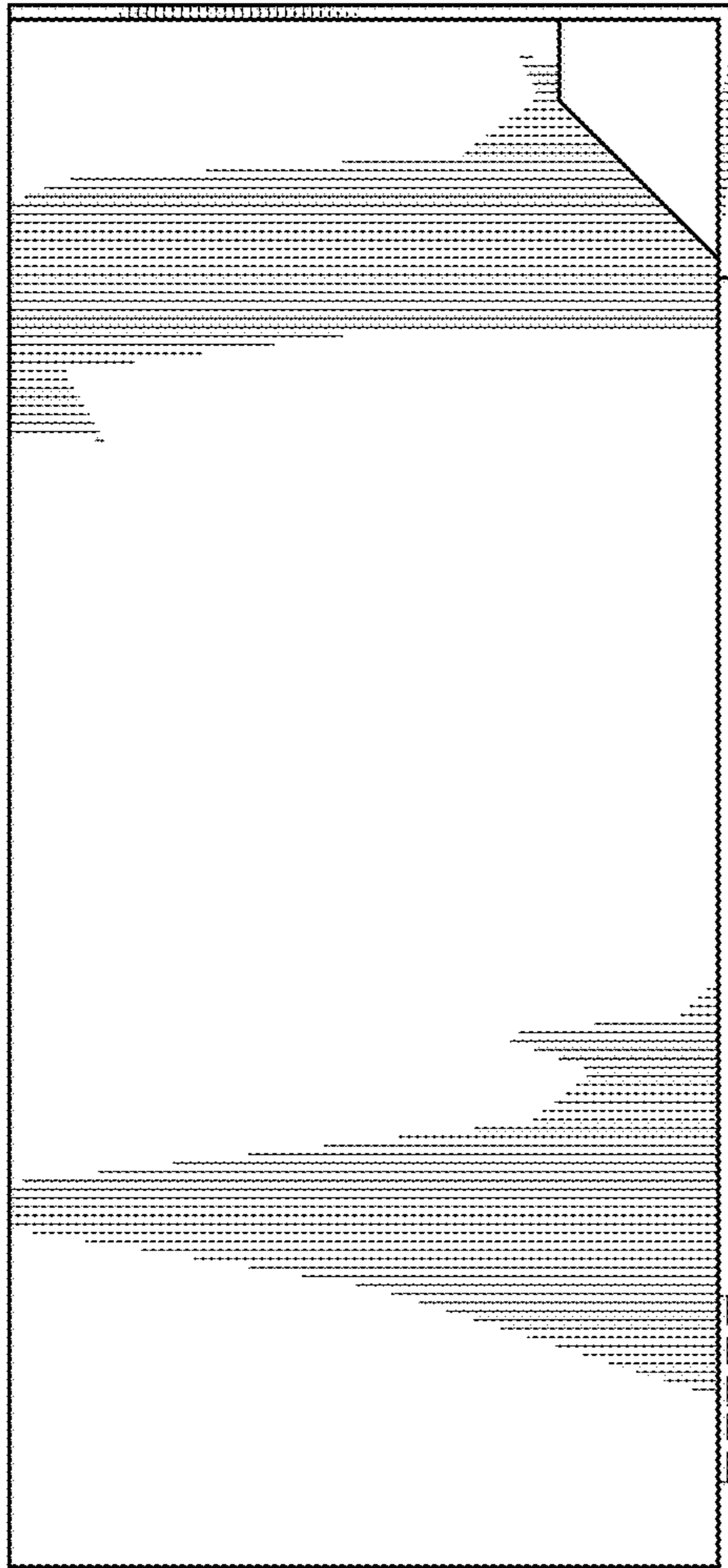
U.S. PATENT DOCUMENTS

D738,202 S \* 9/2015 Stone ..... D9/418  
D748,470 S \* 2/2016 Mohn ..... D9/432  
D754,486 S \* 4/2016 Ott ..... D7/624.2  
2011/0192118 A1\* 8/2011 Kaneko ..... B65D 5/064  
53/458  
2013/0284797 A1\* 10/2013 Ouillette ..... B65D 5/46016  
229/117.16

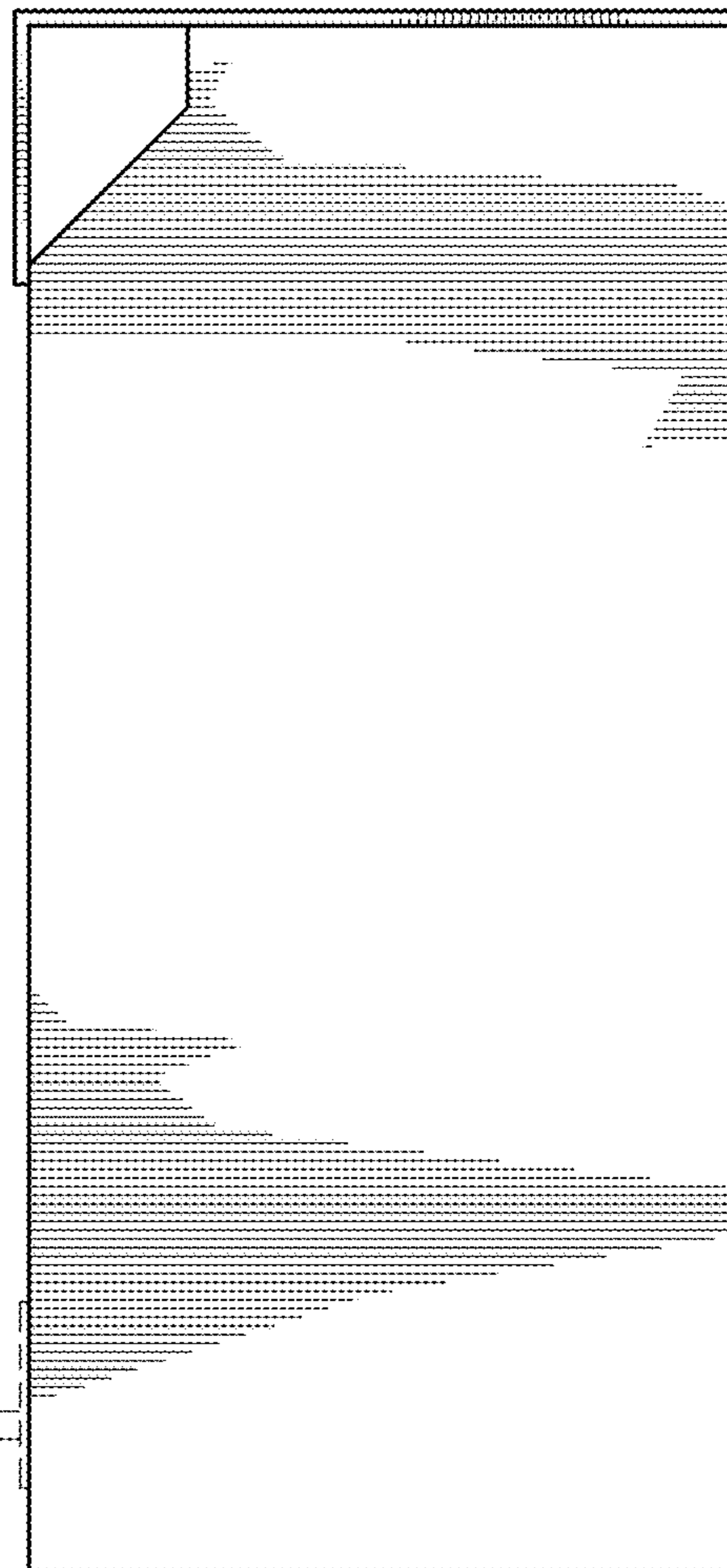
\* cited by examiner



*FIG. 1*



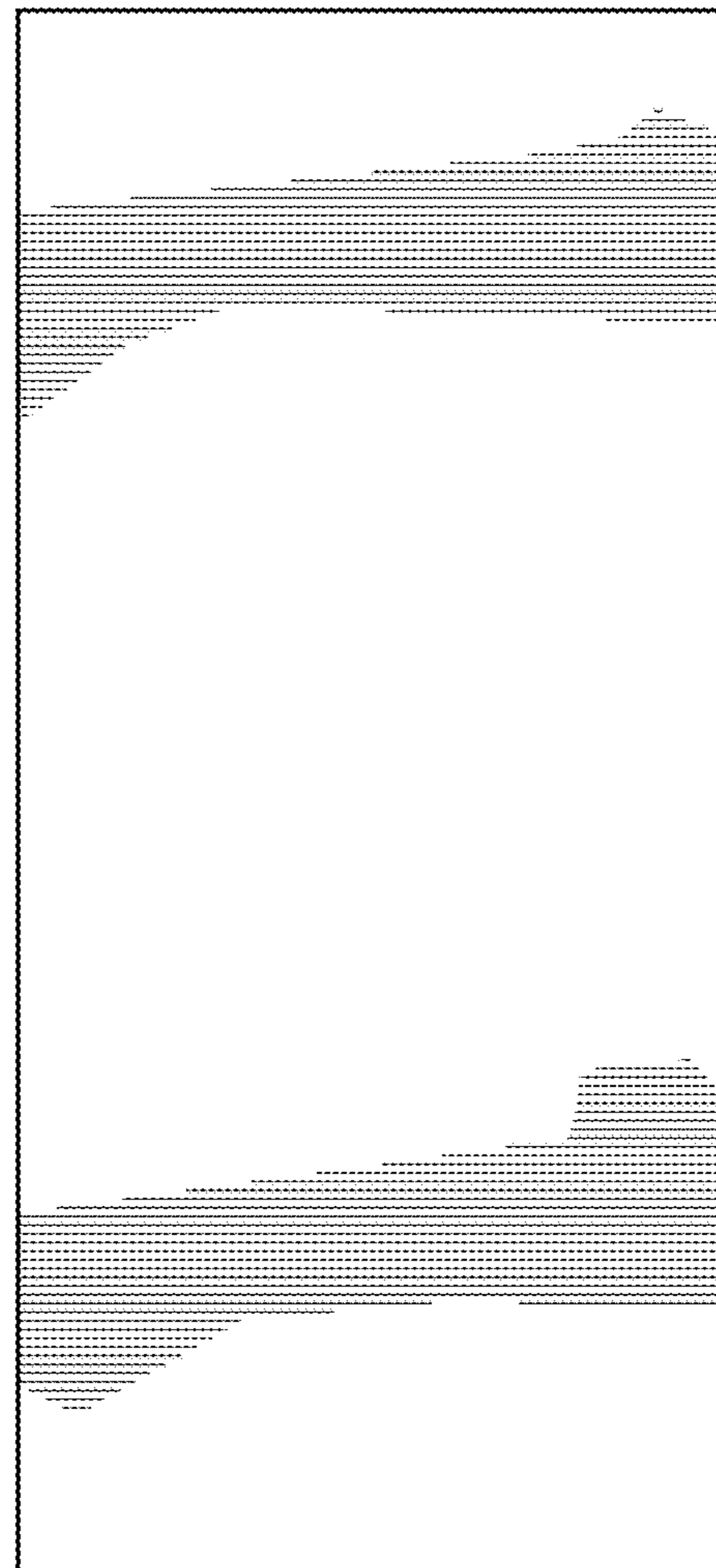
*FIG. 2*



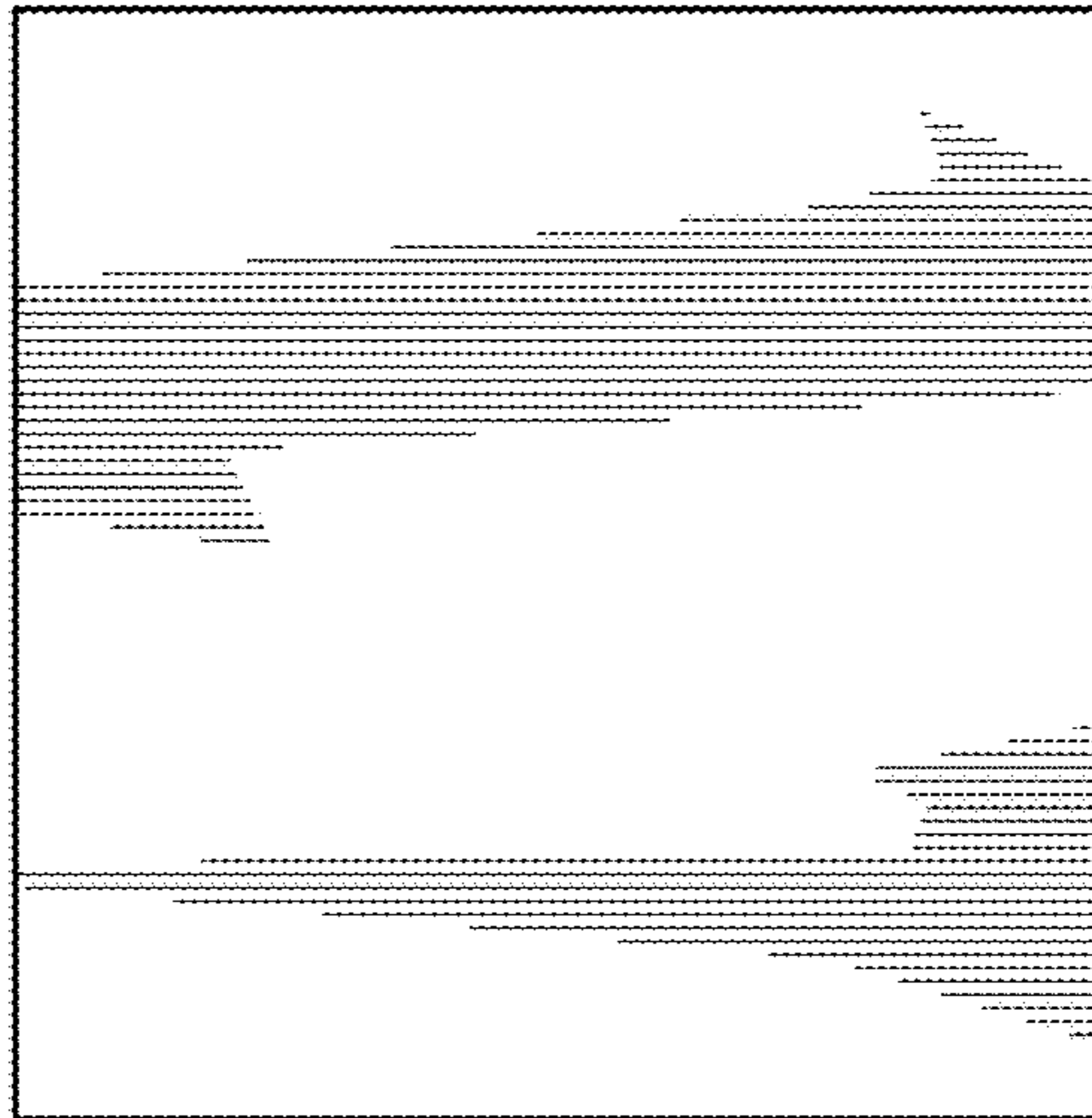
*FIG. 3*



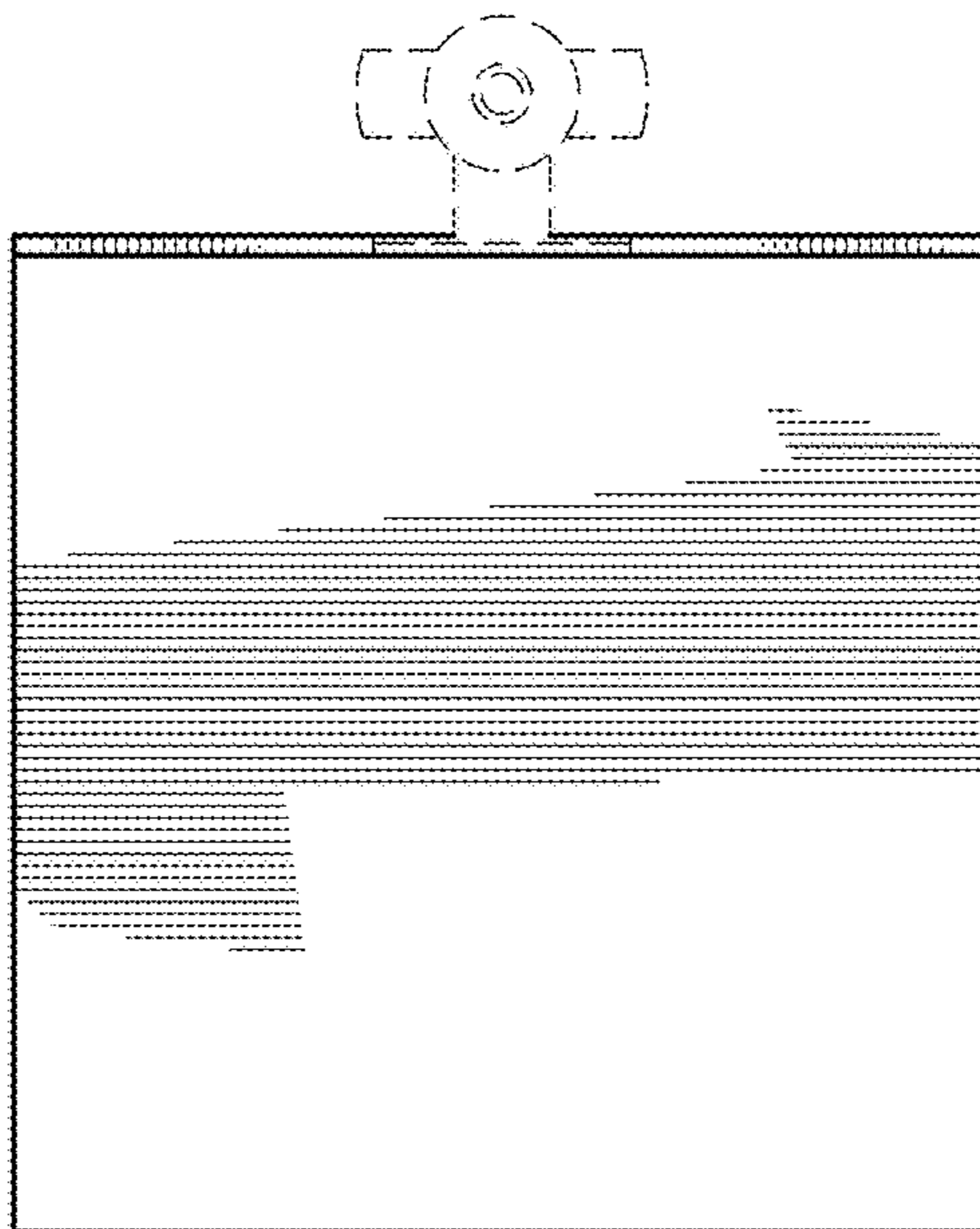
*FIG. 4*



*FIG. 5*

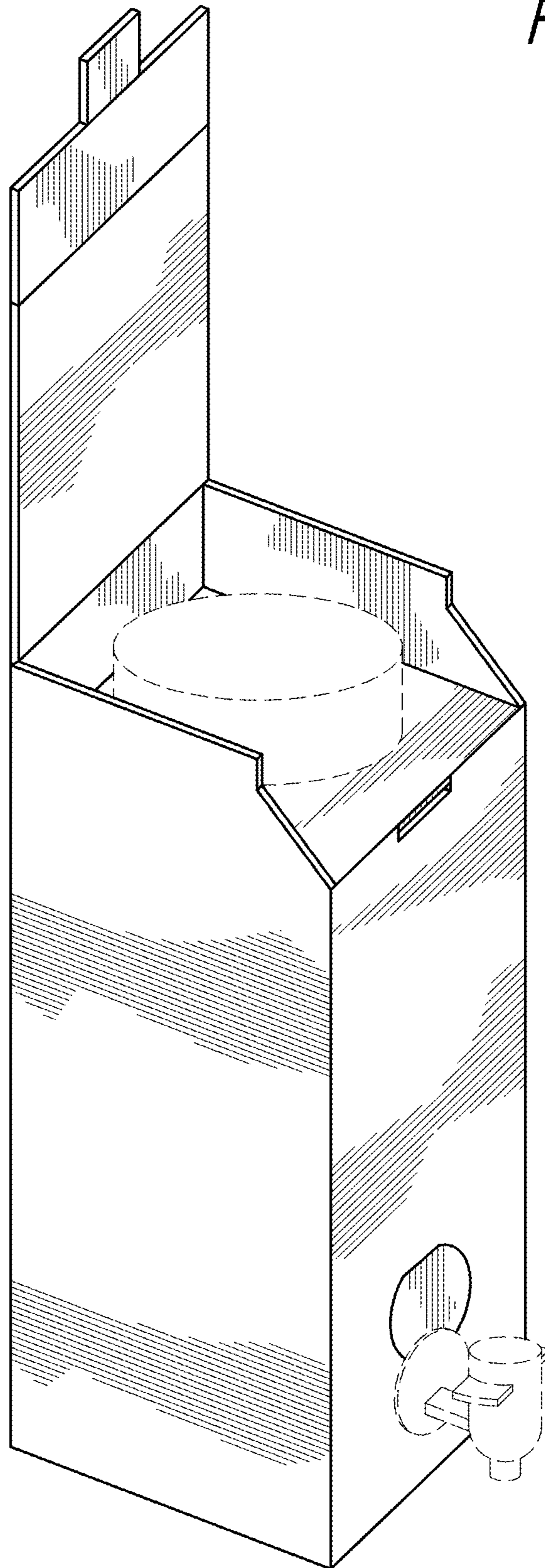


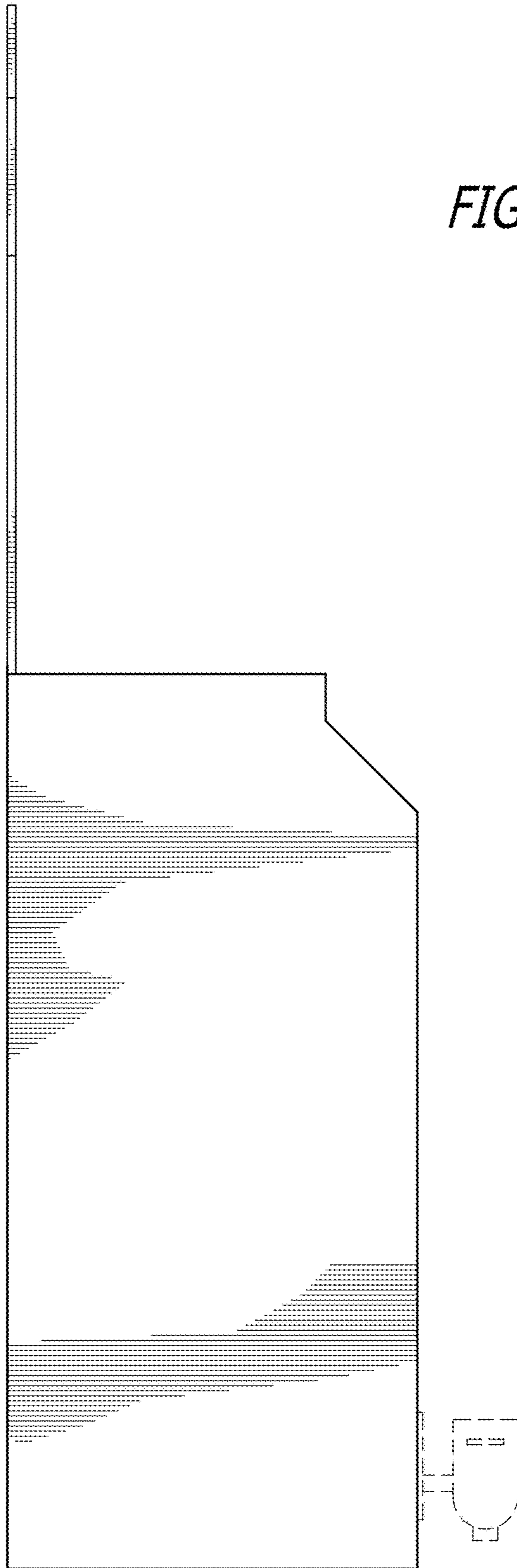
*FIG. 6*



*FIG. 7*

*FIG. 8*





*FIG. 9*



*FIG. 10*

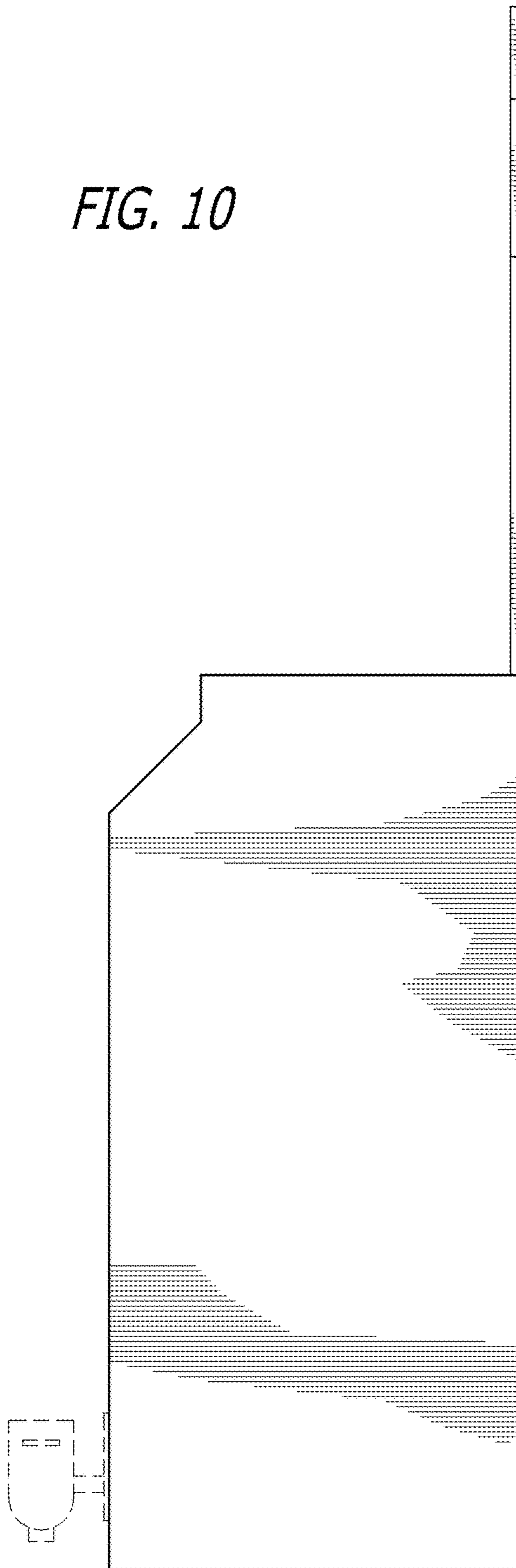


FIG. 11

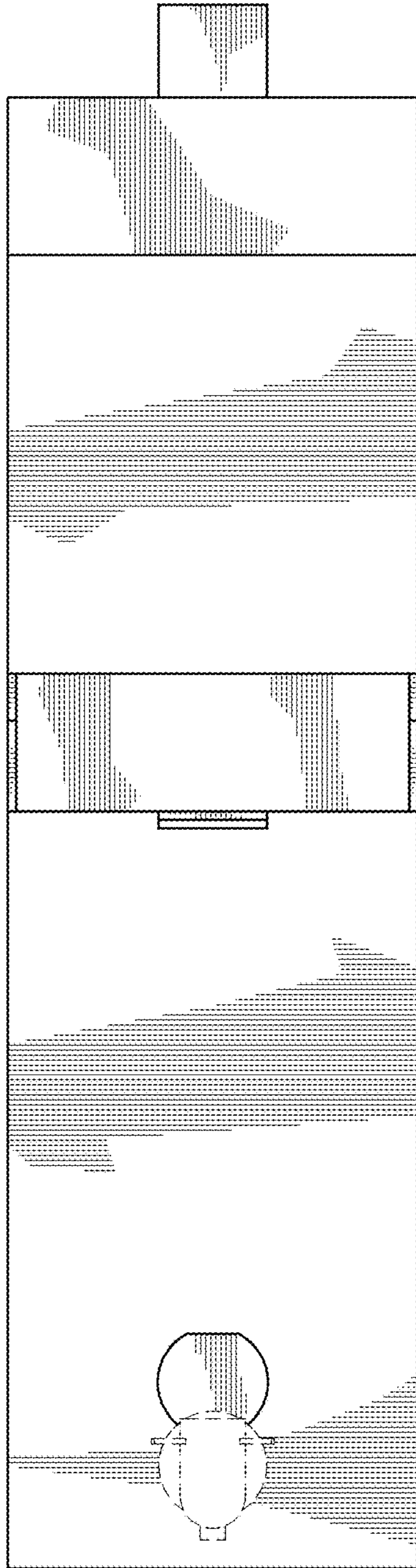
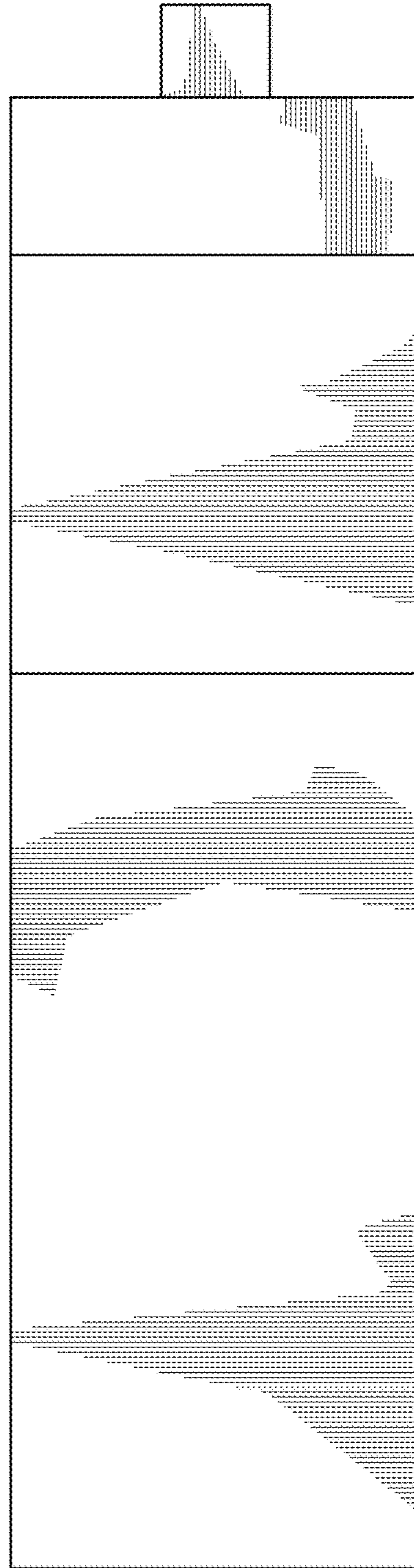
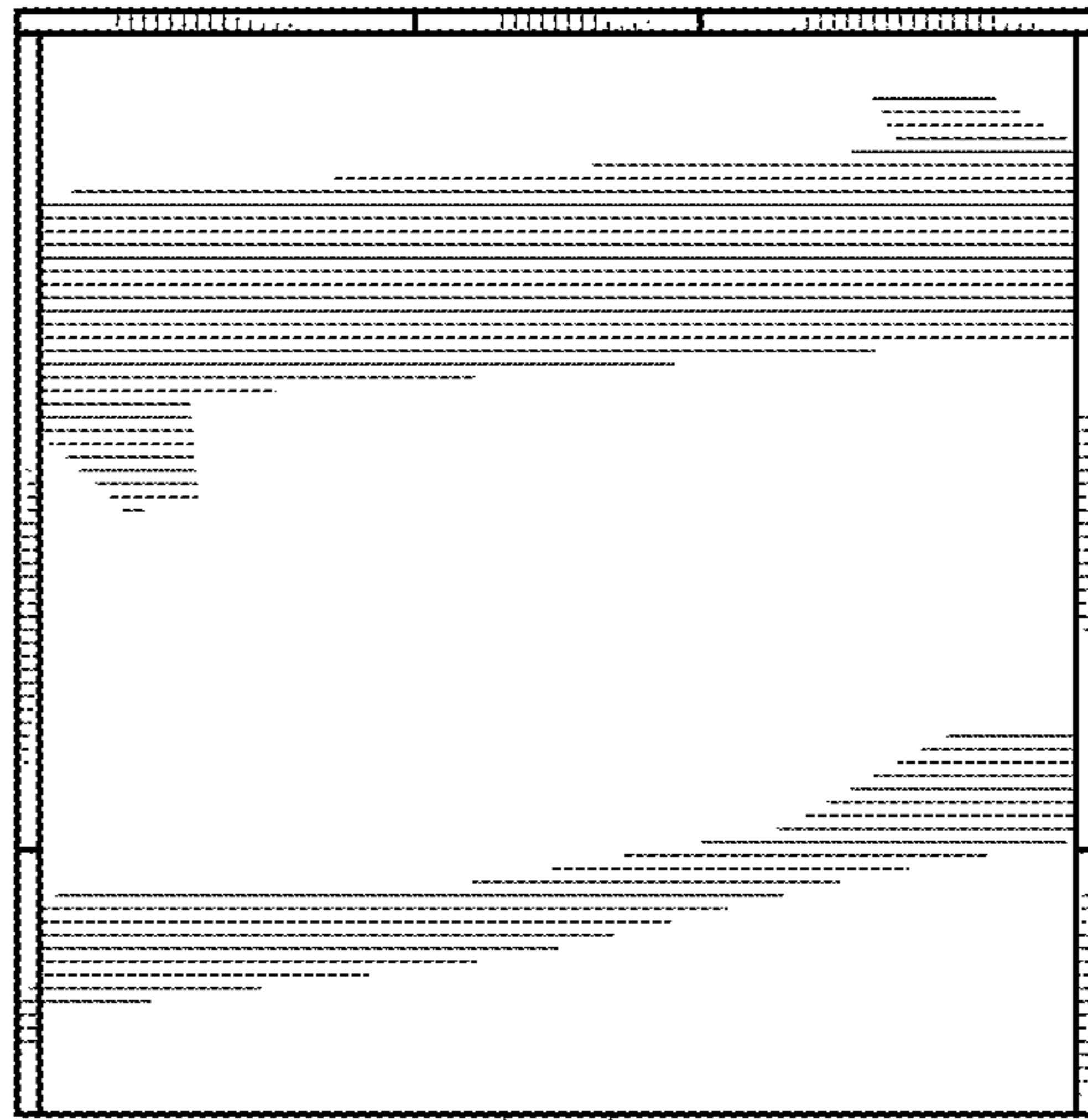
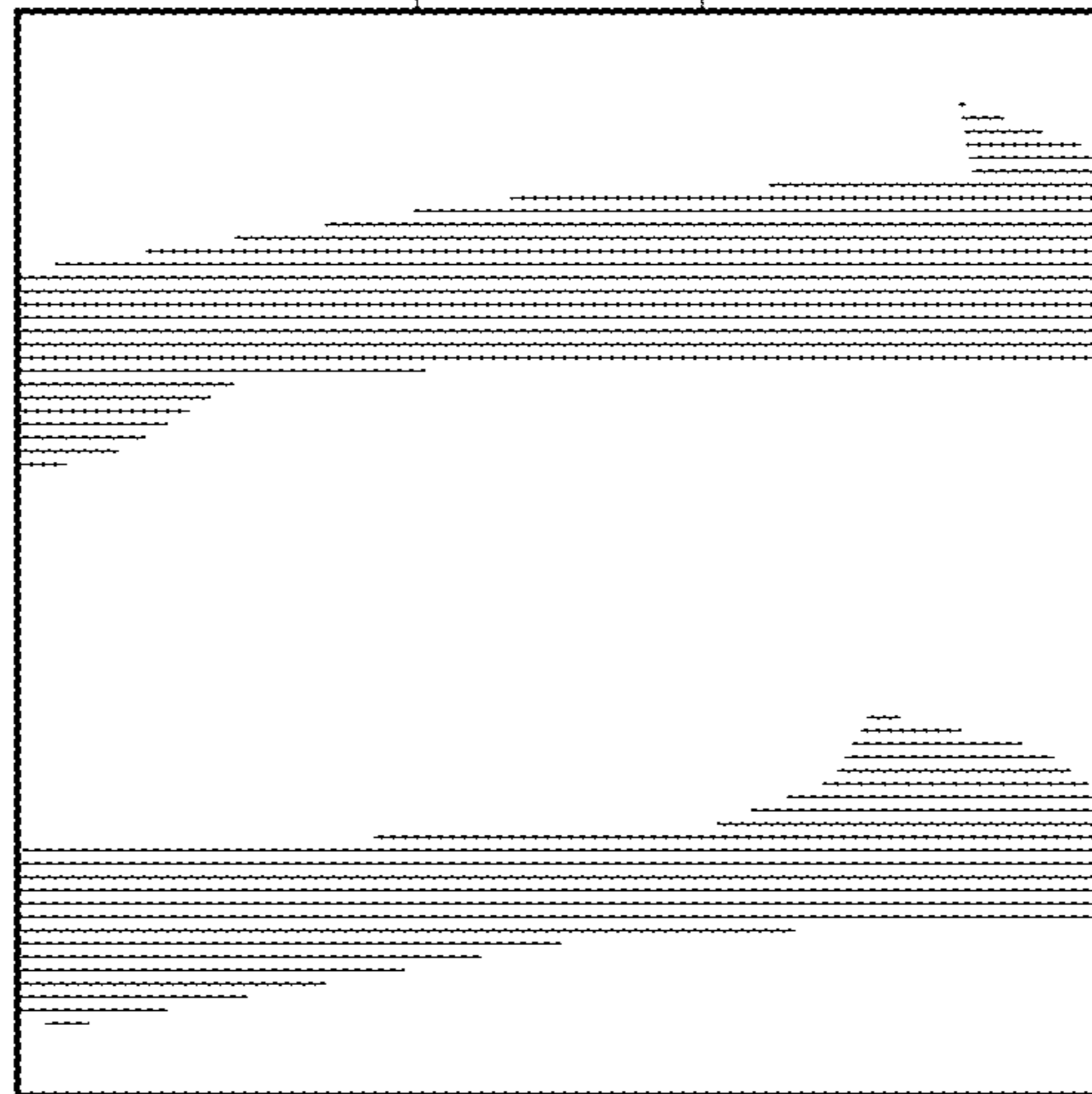
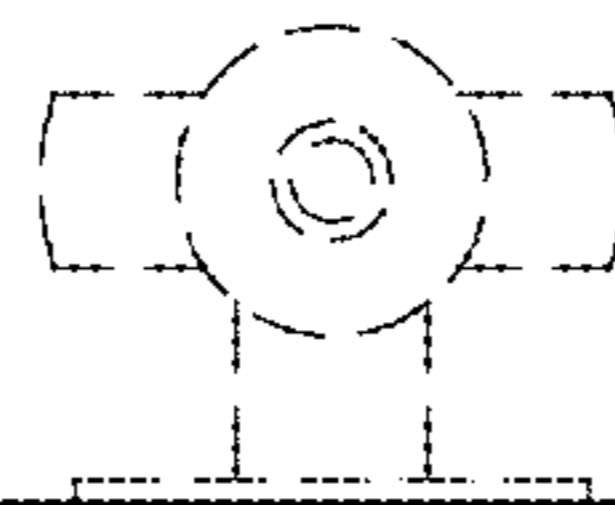
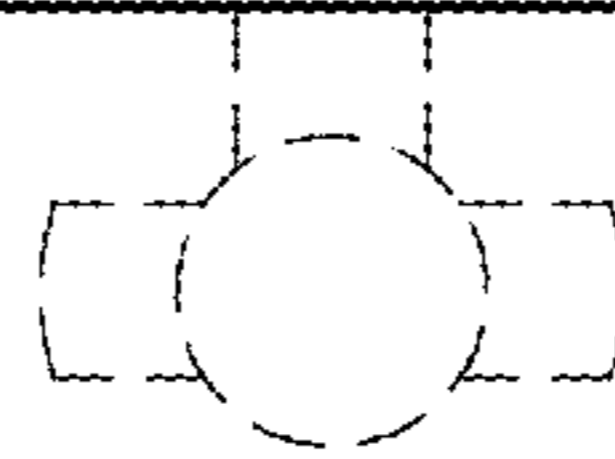


FIG. 12





*FIG. 13*



*FIG. 14*