



US00D781105S

(12) **United States Design Patent**
Wolff et al.

(10) **Patent No.:** **US D781,105 S**
(45) **Date of Patent:** **** Mar. 14, 2017**

(54) **BEER BONG**

(71) Applicants: **Connor Wolff**, Clearwater Beach, FL
(US); **Russ Wardhaugh**, Danville, CA
(US)

(72) Inventors: **Connor Wolff**, Clearwater Beach, FL
(US); **Russ Wardhaugh**, Danville, CA
(US)

(**) Term: **15 Years**

(21) Appl. No.: **29/534,103**

(22) Filed: **Jul. 26, 2015**

(51) **LOC (10) Cl.** **07-01**

(52) **U.S. Cl.**
USPC **D7/515; D7/302; D7/301**

(58) **Field of Classification Search**
USPC D7/514, 515, 516, 517, 519, 520, 536,
D7/513, 300.2, 518, 521, 510, 507, 531,
D7/301, 302; D9/307, 668; 220/700;
D30/129; D21/733, 734, 736, 747;
206/217
CPC A47G 19/2227; A47G 21/145; A47G
23/0208; A45D 27/14; A63B 53/00;
A63B 53/0466; A63B 53/02

See application file for complete search history.

(56) **References Cited**

U.S. PATENT DOCUMENTS

- RE16,800 E * 11/1927 Polachek et al. E06B 3/44
49/209
- D126,813 S * 4/1941 Karoff D3/255
- 2,639,804 A * 5/1953 Merahn A63B 53/00
206/217
- D187,401 S * 3/1960 Whittle D21/733
- D246,003 S * 10/1977 Shimada D21/752

- D285,231 S * 8/1986 Solomon D21/733
- D313,534 S * 1/1991 Stadtmueller D7/506
- D347,968 S * 6/1994 Friedman D7/302
- D360,805 S * 8/1995 Friedman D7/302
- D363,100 S * 10/1995 Long D21/733
- D364,318 S * 11/1995 Chih D7/515
- D370,829 S * 6/1996 Neale D7/515
- D373,508 S * 9/1996 Shin D7/515
- D380,123 S * 6/1997 Friedlander D21/733
- D399,898 S * 10/1998 Stone D21/733
- D401,465 S * 11/1998 Naranjo D7/300.2
- D430,248 S * 8/2000 Adams D21/757
- D463,705 S * 10/2002 Chaput D7/301
- 6,463,662 B1 * 10/2002 Coscia A47G 21/181
30/141
- D470,553 S * 2/2003 Helmstetter D21/733
- 7,047,648 B1 * 5/2006 LeBel A47G 21/181
30/141
- D573,405 S * 7/2008 Bruce D7/507

(Continued)

Primary Examiner — Marianne Pandozzi

(74) *Attorney, Agent, or Firm* — Evergreen Valley Law
Group; Kanika Radhakrishnan

(57) **CLAIM**

The ornamental design for a beer bong, as shown and
described.

DESCRIPTION

FIG. 1 is a perspective view of a beer bong showing our new
design;
FIG. 2 is an enlarged perspective view thereof;
FIG. 3 is an enlarged front view thereof;
FIG. 4 is an enlarged rear view thereof;
FIG. 5 is an enlarged right side view thereof;
FIG. 6 is an enlarged left side view thereof;
FIG. 7 is an enlarged top plan view thereof; and,
FIG. 8 is an enlarged bottom plan view thereof.

1 Claim, 8 Drawing Sheets

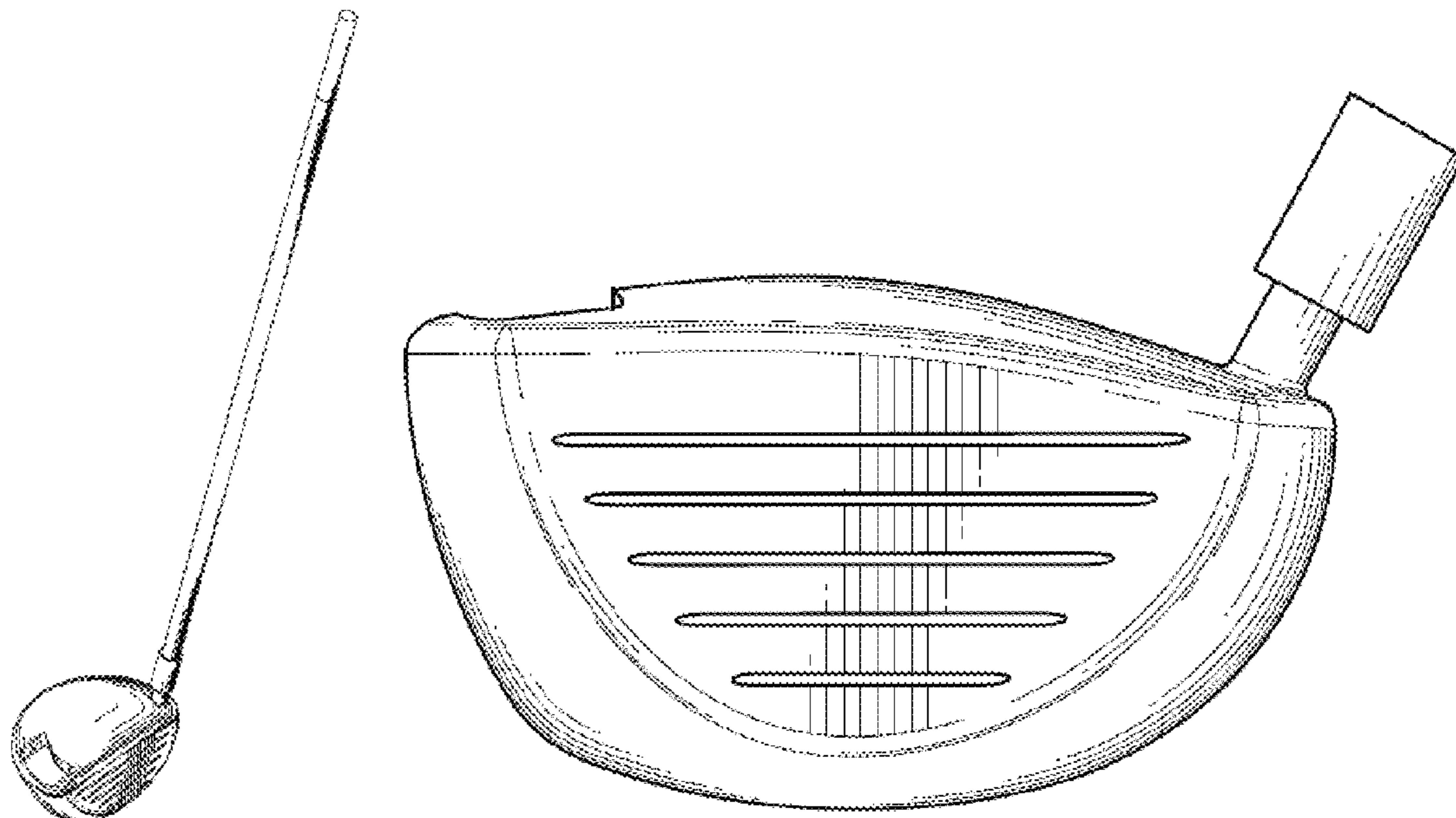

(56)

References Cited

U.S. PATENT DOCUMENTS

7,658,130	B1 *	2/2010	Porteous	A63B 53/04 473/324
8,069,500	B2 *	12/2011	Seskin	A61G 9/006 4/144.1
8,096,896	B2 *	1/2012	De Schiell	A63B 53/0466 473/342
D684,866	S *	6/2013	Shulakewych	D21/727
8,961,335	B2 *	2/2015	Sugimoto	A63B 53/0466 473/332
D734,084	S *	7/2015	Hollander	D7/300.2
9,393,473	B2 *	7/2016	Knight	A63B 53/0466
D769,044	S *	10/2016	Hollander	D7/300.2
9,486,677	B1 *	11/2016	Seluga	A63B 53/0466
2015/0024865	A1 *	1/2015	Nakamura	A63B 53/0466 473/292

* cited by examiner

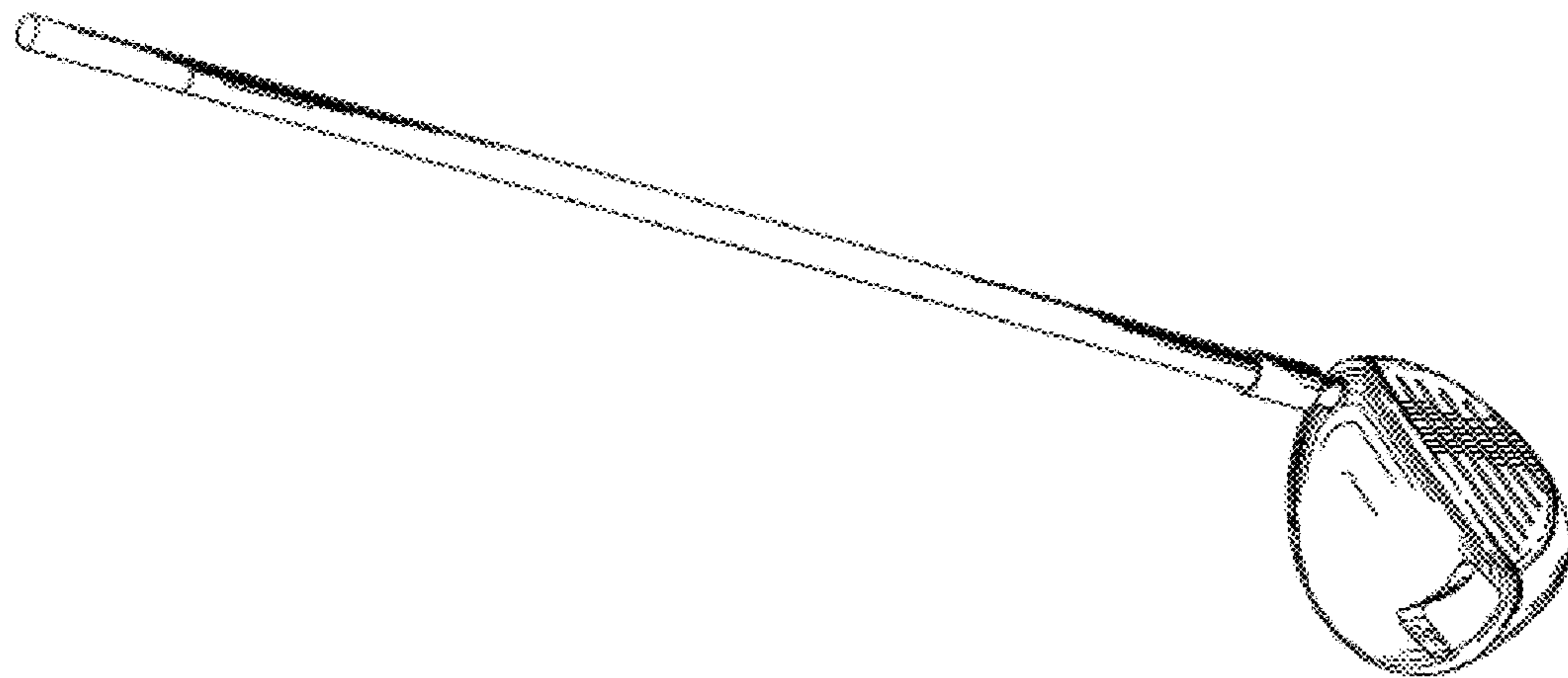

FIG. 1

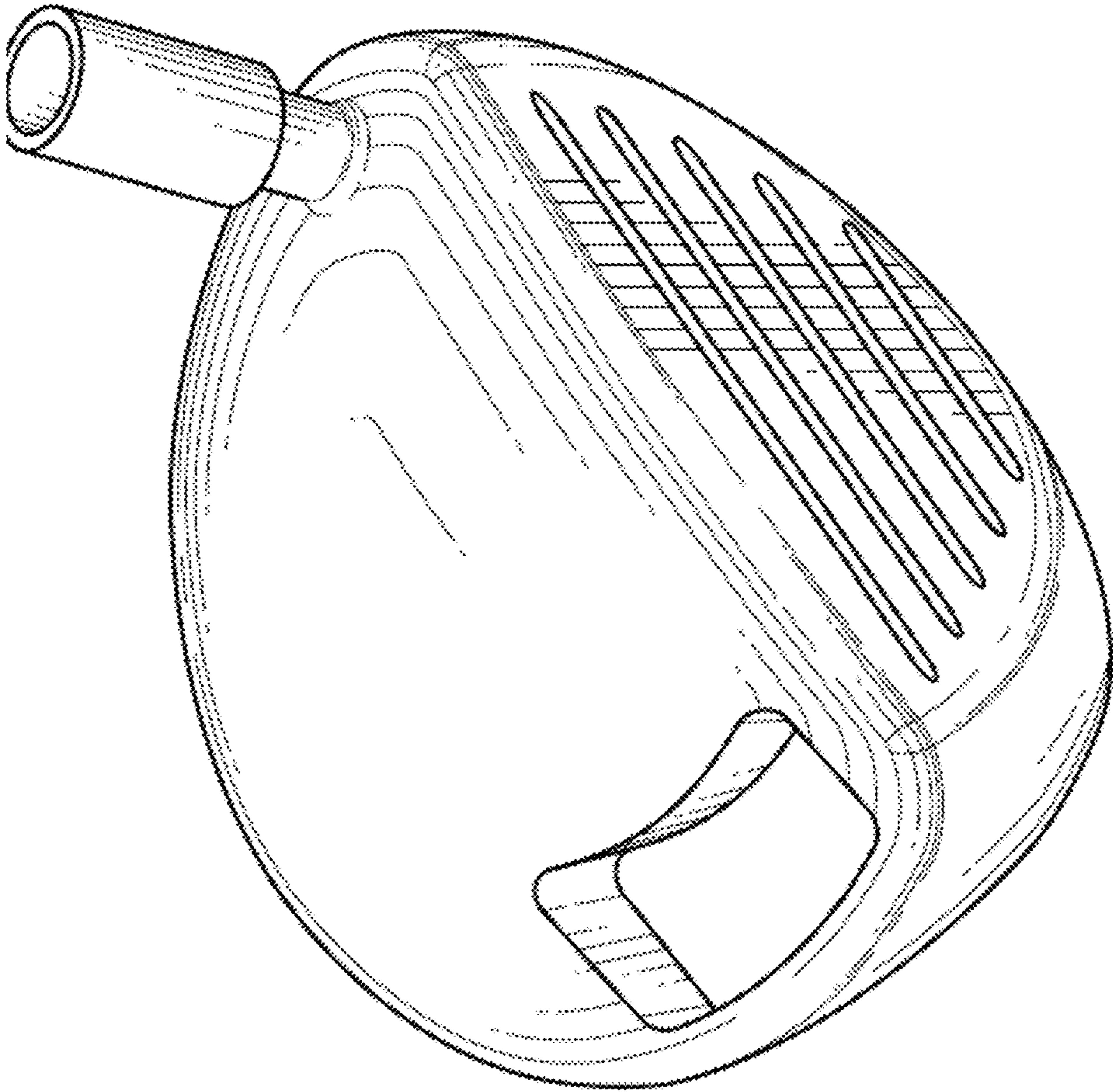

FIG. 2

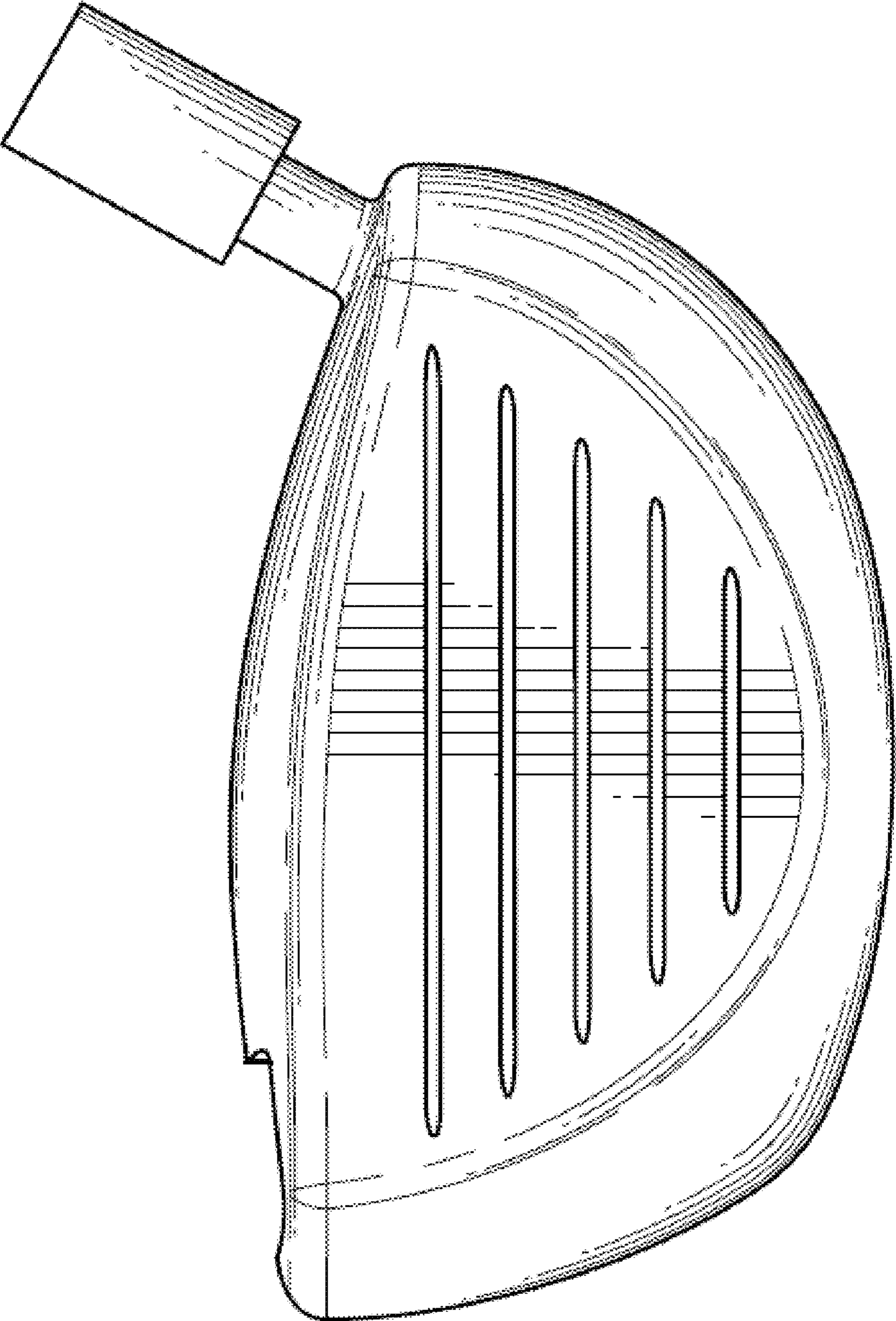

FIG. 3

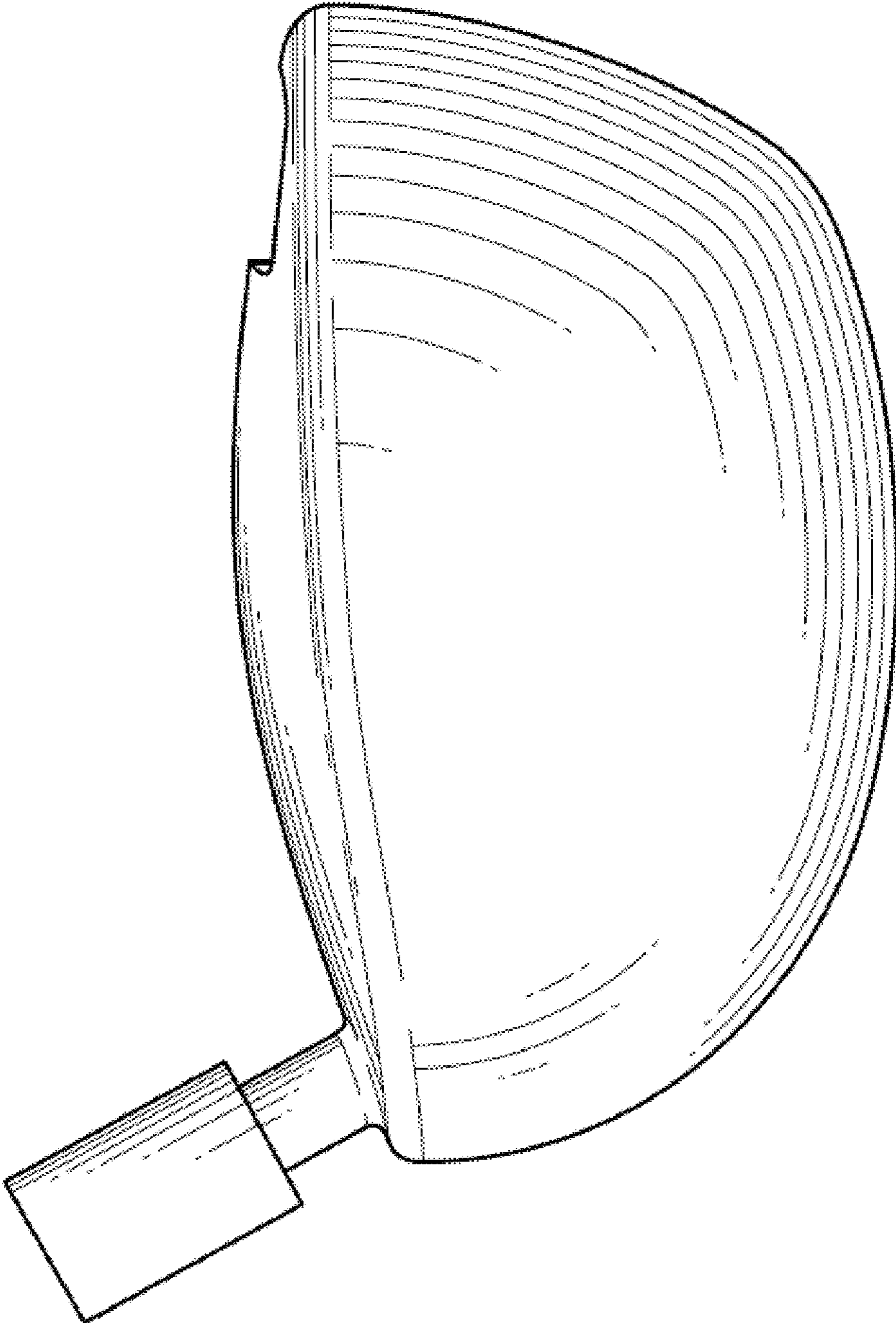

FIG. 4

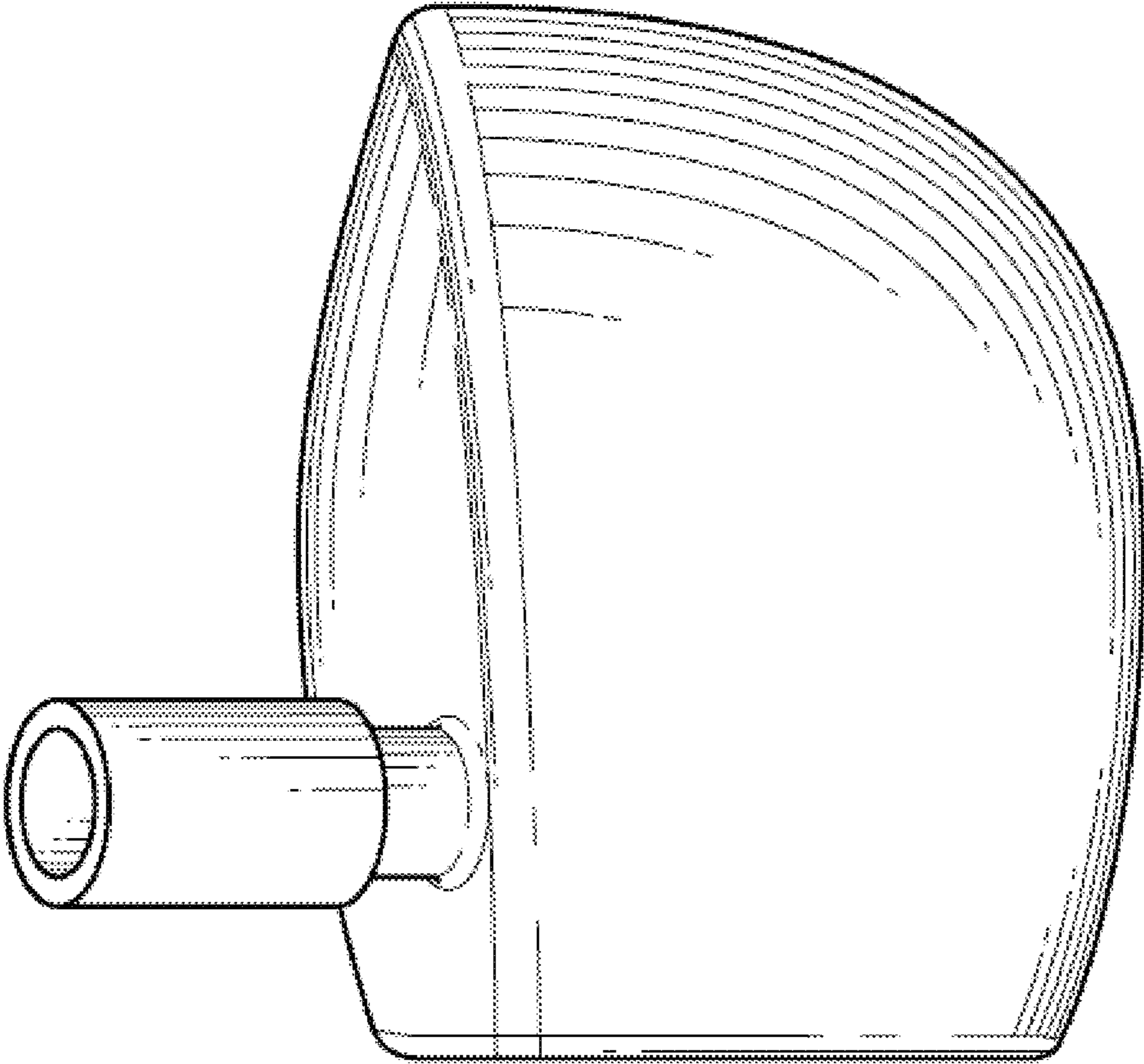

FIG. 5

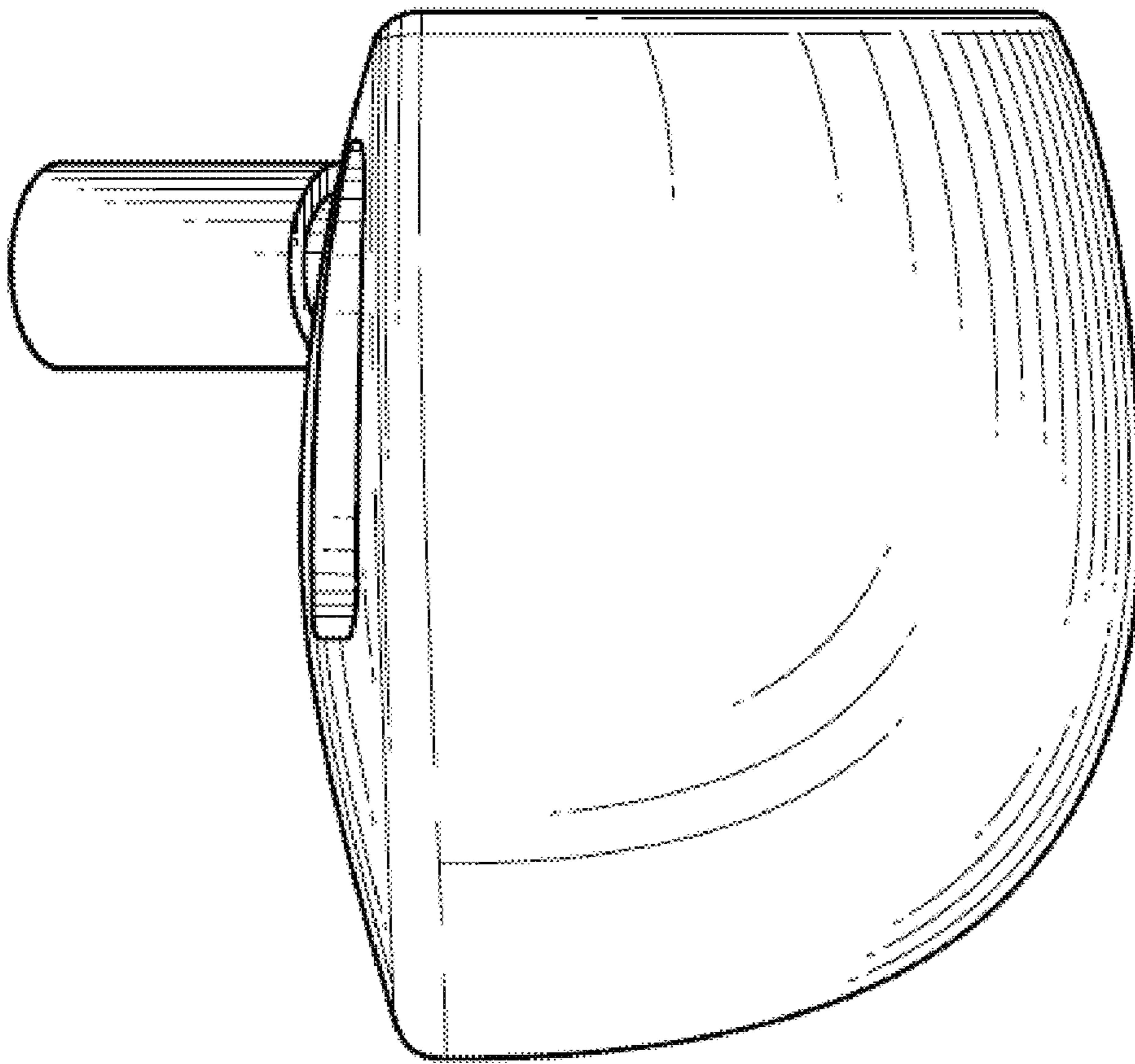

FIG. 6

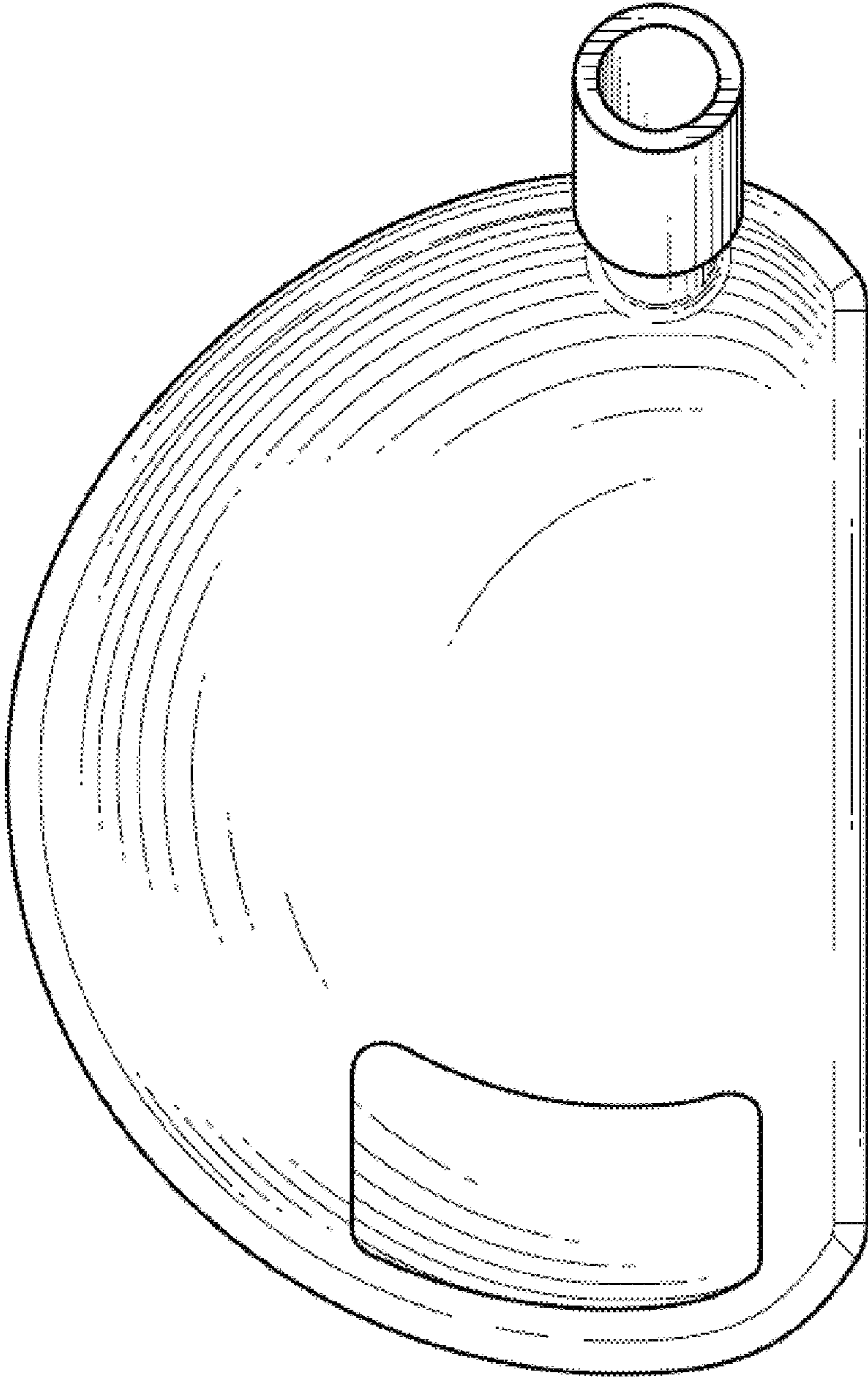

FIG. 7

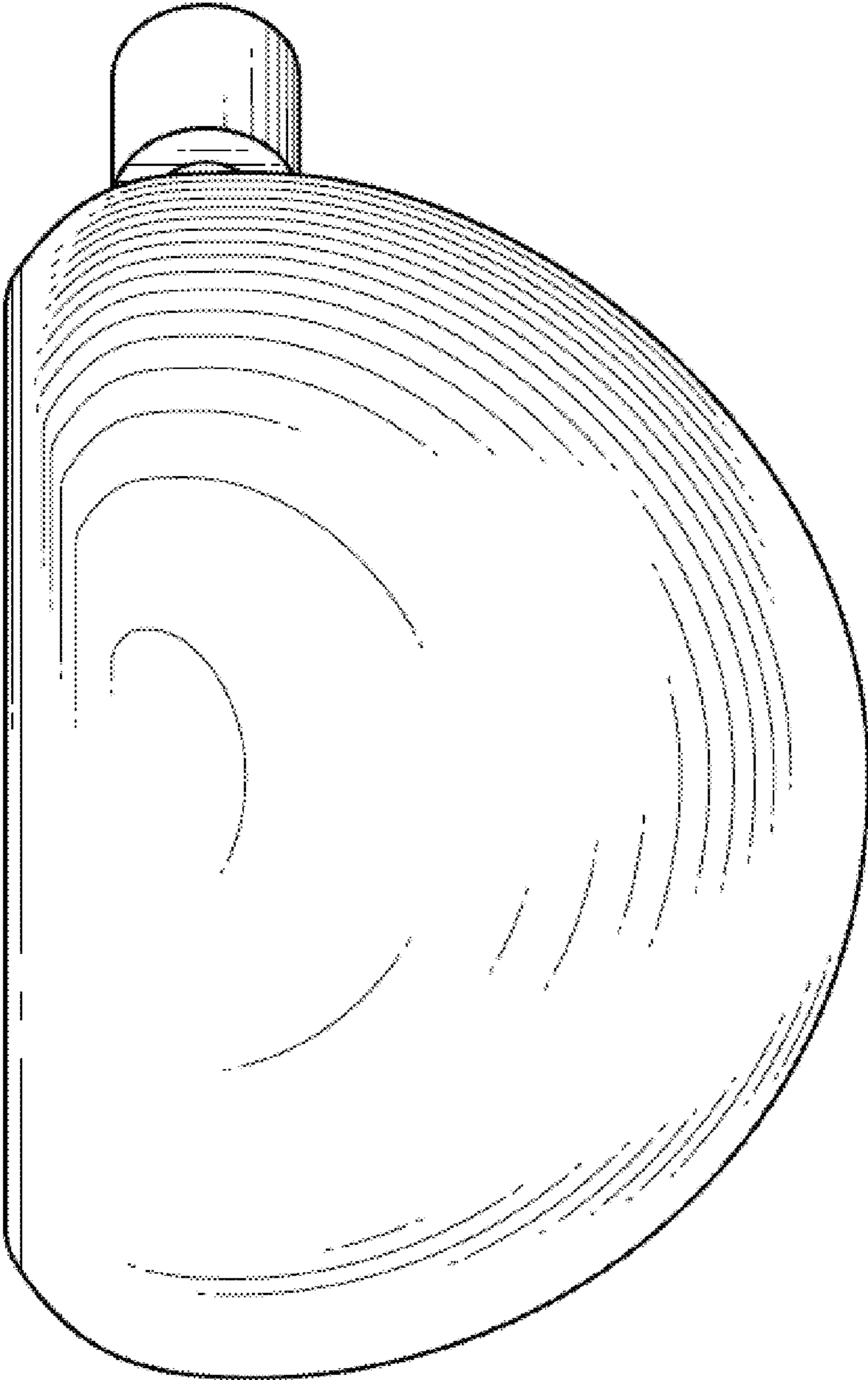

FIG. 8