



US00D781090S

(12) **United States Design Patent**
Chalmers

(10) **Patent No.:** **US D781,090 S**

(45) **Date of Patent:** **** Mar. 14, 2017**

(54) **TABLE BASE**

(71) Applicant: **Imagineering, Inc.**, Rockland, ME
(US)

(72) Inventor: **Richard R. Chalmers**, Camden, ME
(US)

(73) Assignee: **Imagineering, Inc.**, Rockland, ME
(US)

(**) Term: **14 Years**

(21) Appl. No.: **29/521,189**

(22) Filed: **Mar. 20, 2015**

(51) **LOC (10) Cl.** **06-04**

(52) **U.S. Cl.**

USPC **D6/708**

(58) **Field of Classification Search**

USPC D6/334-336, 349, 351, 352, 358, 360,
D6/364, 365, 366, 374, 375, 379, 380,
(Continued)

(56) **References Cited**

U.S. PATENT DOCUMENTS

D135,508 S 4/1943 Mildwoff
2,635,023 A * 4/1953 Frye A47B 13/02
108/12

(Continued)

OTHER PUBLICATIONS

“Sophia V Contemporary Dining Base” Aug. 28, 2014, Gillberg Design Inc., site visited Sep. 16, 2016 <<http://gillbergdesign.com/tables-bases>>.*

(Continued)

Primary Examiner — Kevin Rudzinski

Assistant Examiner — Paul Bohannon

(74) *Attorney, Agent, or Firm* — Heslin Rothenberg Farley & Mesiti P.C.

(57) **CLAIM**

The ornamental design for a table base, as shown and described.

DESCRIPTION

FIG. 1 is a perspective view of a table base in accordance with the new design;

FIG. 2 is a front elevational view thereof;

FIG. 3 is a left side elevational view thereof;

FIG. 4 is a right side elevational view thereof;

FIG. 5 is a rear elevational view thereof;

FIG. 6 is a top view thereof;

FIG. 7 is a bottom view thereof;

FIG. 8 is a perspective view of an alternative embodiment of the table base, shown with a symbolic break in its length, the appearance of any portion of the table base between the break lines forms no part of the claimed design, which is the sole difference between it and FIGS. 1-7;

FIG. 9 is a perspective view of an alternative embodiment of the table base, shown with a symbolic break in its width, the appearance of any portion of the table base between the break lines forms no part of the claimed design, which is the sole difference between it and FIGS. 1-7;

FIG. 10 is another perspective view of the table base disposed in a second orientation;

FIG. 11 is a front elevational view thereof;

FIG. 12 is a left side elevational view thereof;

FIG. 13 is a right side elevational view thereof;

FIG. 14 is a rear elevational view thereof;

FIG. 15 is a top view thereof;

FIG. 16 is a bottom view thereof;

FIG. 17 is a perspective view of an alternative embodiment of the table base, shown with a symbolic break in its length, the appearance of any portion of the table base between the break lines forms no part of the claimed design, which is the sole difference between it and FIGS. 10-16;

FIG. 18 is a perspective view of an alternative embodiment of the table base, shown with a symbolic break in its width, the appearance of any portion of the table base between the break lines forms no part of the claimed design, which is the sole difference between it and FIGS. 10-16; and,

FIG. 19 is a left side elevational view thereof, a right side elevational view being a mirror image thereof.

(Continued)

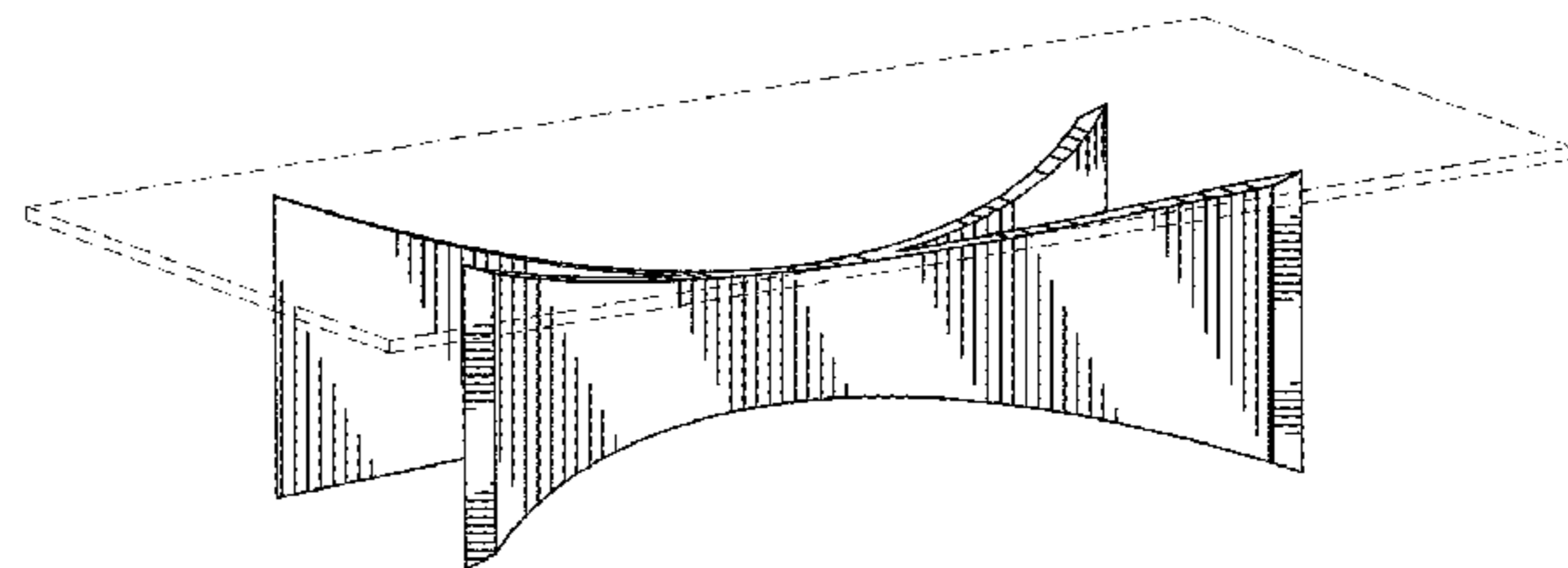
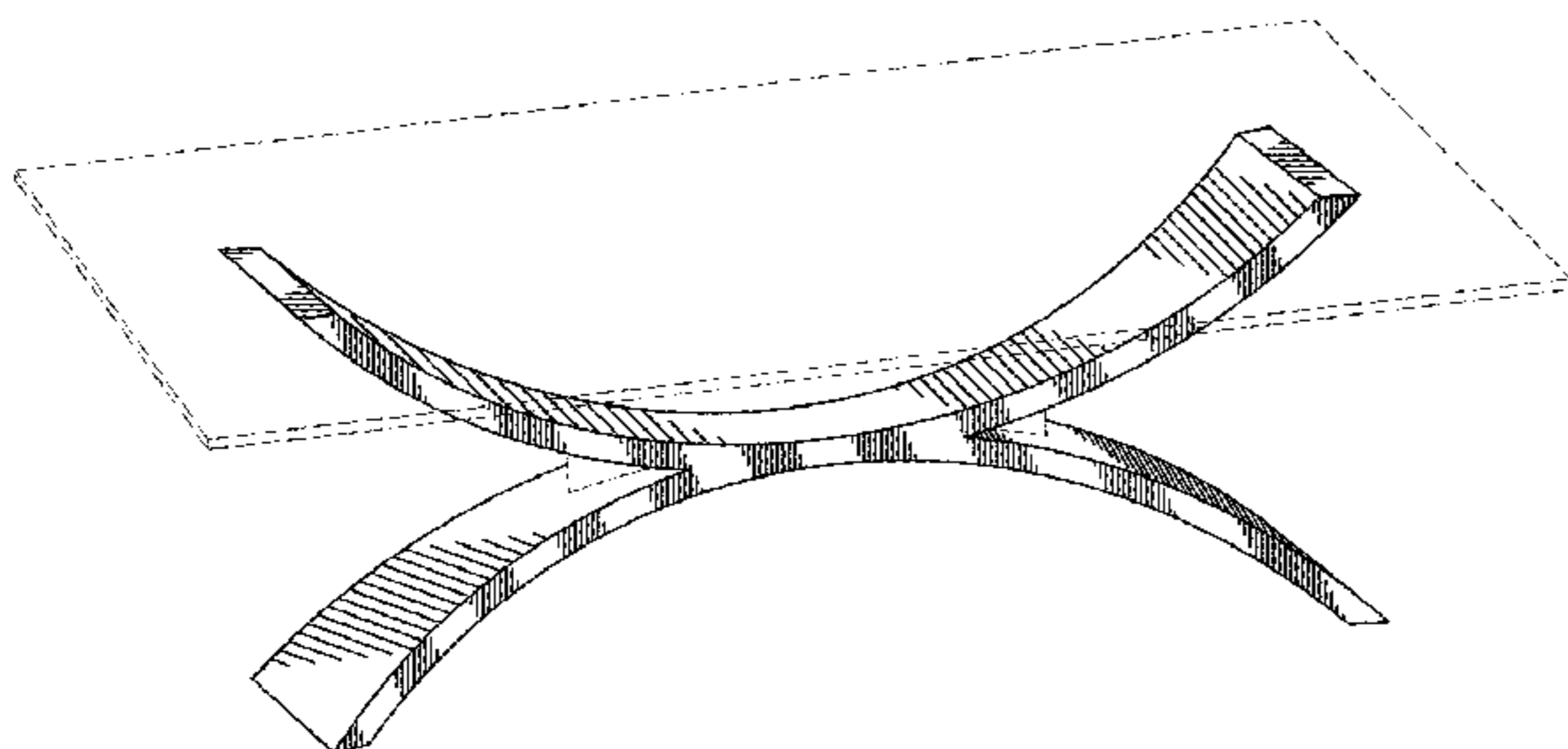

The broken lines in the figures are included for illustrating environment and the symbolic break and form no part of the claimed design.

1 Claim, 18 Drawing Sheets

(58) **Field of Classification Search**

USPC D6/657, 662.1, 672, 674, 675, 675.1, D6/675.3, 683, 683.1, 685, 691, 691.5, D6/702, 708, 708.2, 708.21, 708.25, 716, D6/716.1-716.4; D3/304, 307, 309
 CPC A47B 7/00; A47B 2200/001; A47B 2200/002; A47B 2200/0011-2200/0014; A47B 2200/0021-2200/0023; A47B 2200/0026; A47B 2200/0027; A47B 2200/0039; A47B 13/02; A47B 13/021-13/028; A47B 2009/006; A47B 57/402; A47B 67/00; A47B 87/0207; A47B 96/00; A47B 96/02; A47B 43/00; A47B 63/00; A47C 1/04; A47C 1/03255; A47C 1/0255; A47C 3/00; A47C 3/18; A47C 3/026; A47C 4/02; A47C 4/028; A47C 4/54; A47C 7/00; A47C 7/002; A47C 7/004; A47C 7/006; A47C 7/18; A47C 7/022; A47C 7/24; A47C 7/50; A47C 9/002; A47C 9/007; A47D 7/00; A47F 1/00; A47F 3/00; A47F 3/06; A47F 3/14; A47F 7/00; B65D 1/34; B65D 81/3813; B65D 21/00; B65D 5/545; B65D 5/26; B65D 5/0015; B65D 5/0045
 See application file for complete search history.

(56) **References Cited**

U.S. PATENT DOCUMENTS

2,842,416 A * 7/1958 Davock A47B 23/001
 108/158.12
 D200,466 S * 3/1965 Eby D6/349

D225,950 S 1/1973 Kienel
 D227,313 S 6/1973 Elsner
 3,822,078 A * 7/1974 Spadolini A47B 83/02
 297/140
 D259,579 S * 6/1981 Kaye D21/784
 D261,342 S 10/1981 Frye
 D340,158 S 10/1993 Cionini
 D386,632 S 11/1997 Robinson
 D415,371 S * 10/1999 Lewis D6/691
 D446,974 S 8/2001 Muller
 D456,184 S 4/2002 Boles
 D470,350 S 2/2003 Muggleton
 D524,581 S 7/2006 Warriner
 D557,944 S 12/2007 Cheng
 D573,377 S 7/2008 Muller
 D578,323 S 10/2008 Muller
 D596,259 S 7/2009 Deason
 D613,097 S 4/2010 Muller
 D646,081 S * 10/2011 Muller D6/708
 D716,595 S * 11/2014 Muller D6/708
 D716,596 S * 11/2014 Pedersen D6/708
 D724,871 S * 3/2015 Davis D6/691
 D737,526 S * 8/2015 Hong D30/118

OTHER PUBLICATIONS

Under Armor U.S. Trademark Registration No. 2,954,369 consisting of stylized letter “U” and “A” and the words “Under Armor”, 1-page, registered May 24, 2005.
 Allure Glass Coffee Table, available from Raymour & Flanigan Furniture, printout available online on Mar. 19, 2015, at <http://www.raymourflanigan.com/allure-glass-coffee-table-397213960.aspx>, 4-pages, at least as early as Apr. 10, 2011.

* cited by examiner

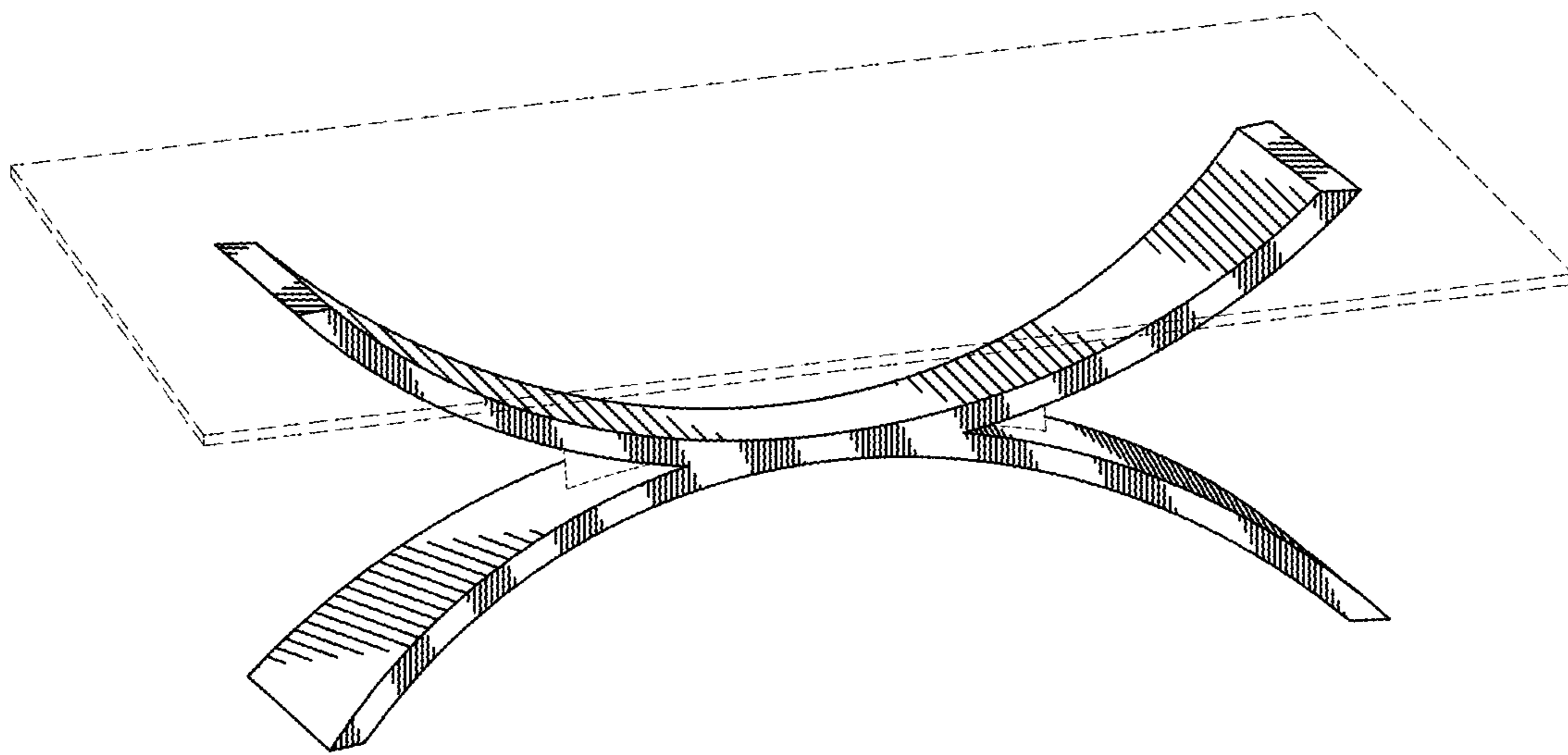

FIG. 1

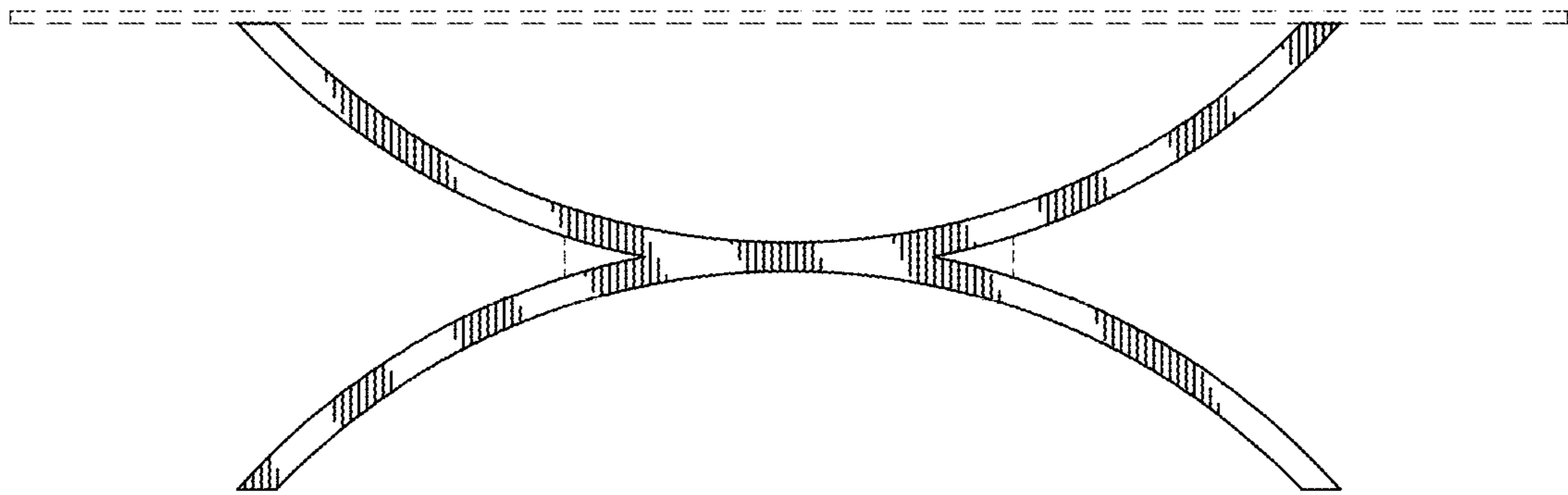

FIG. 2

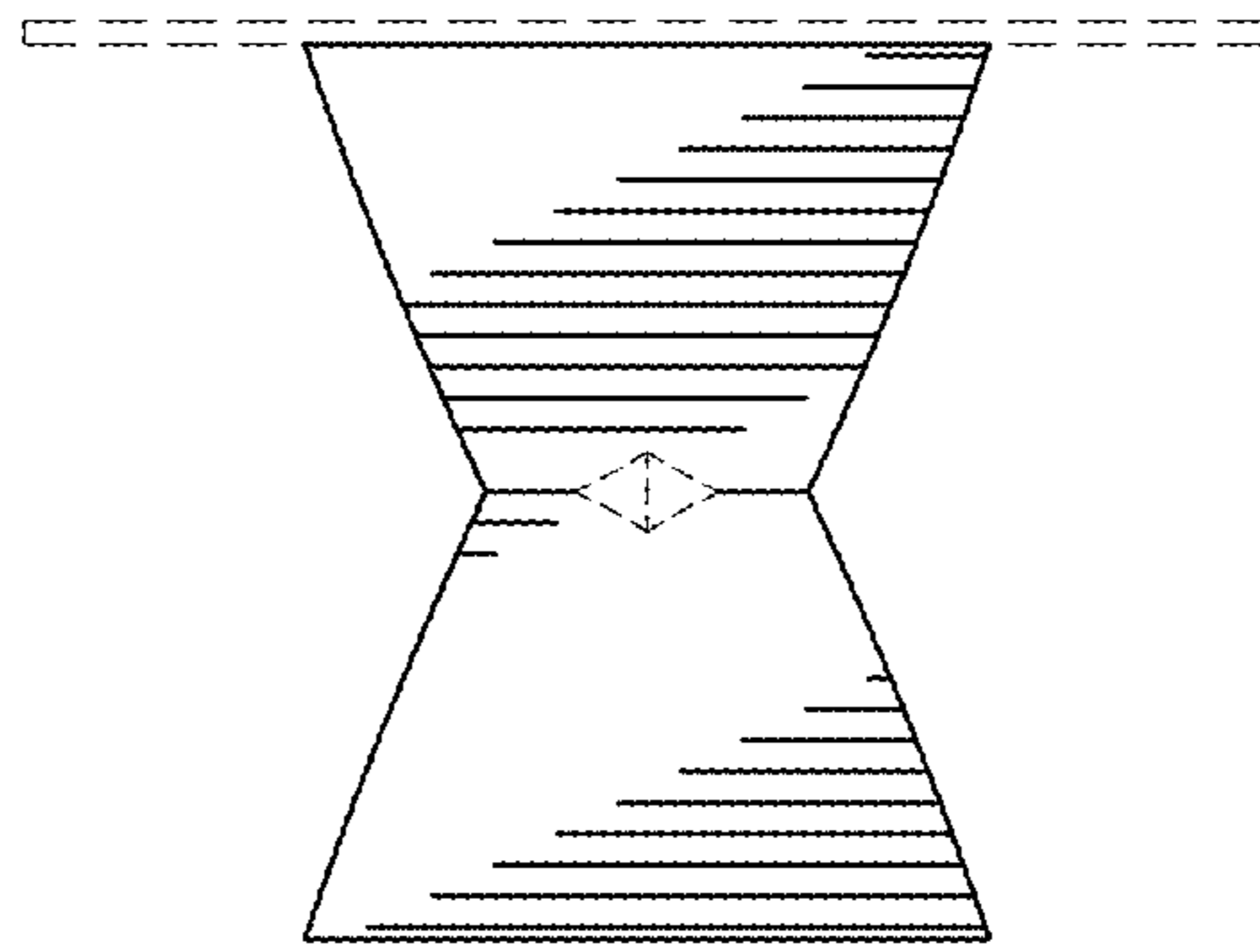

FIG. 3

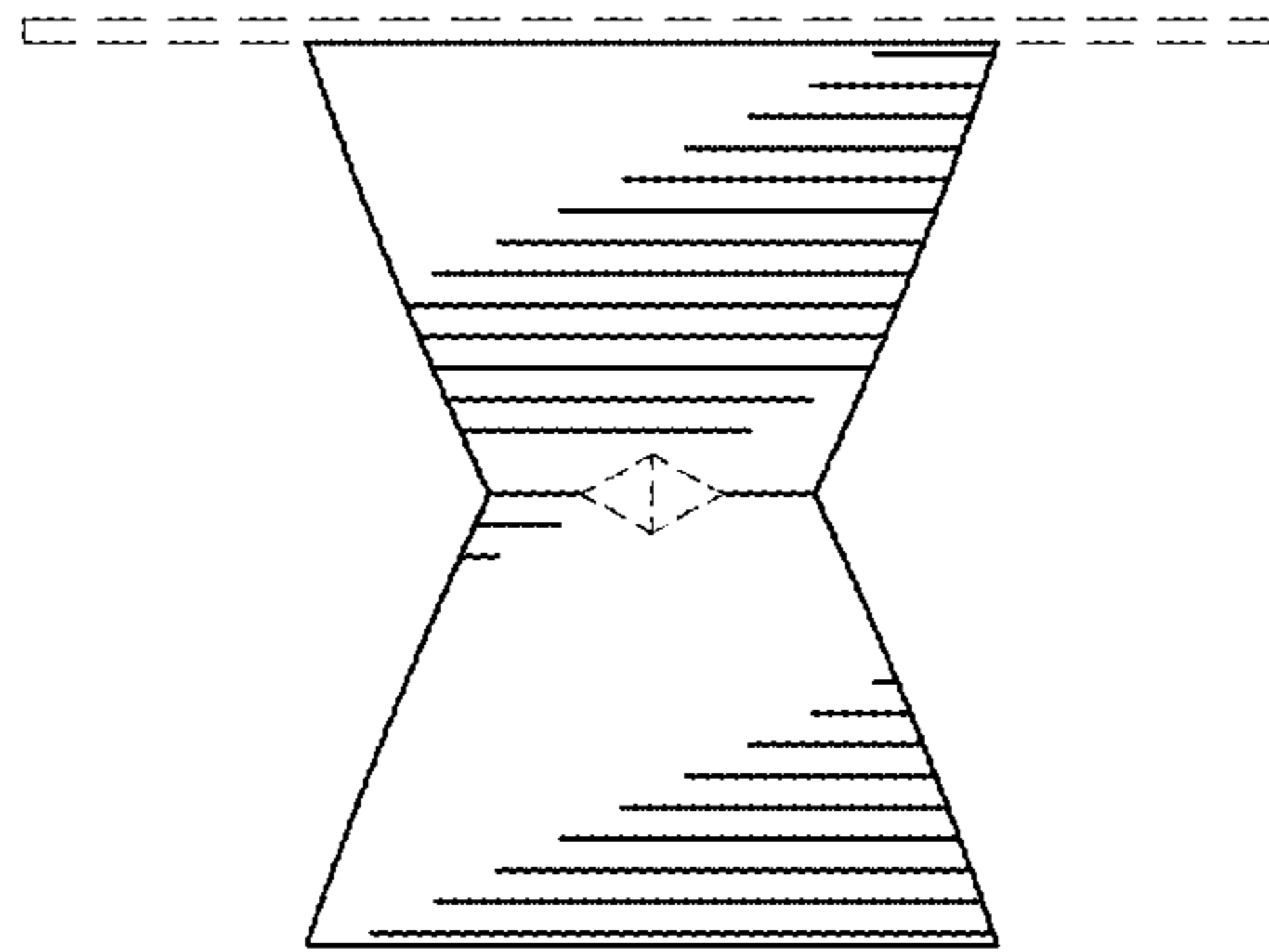

FIG. 4

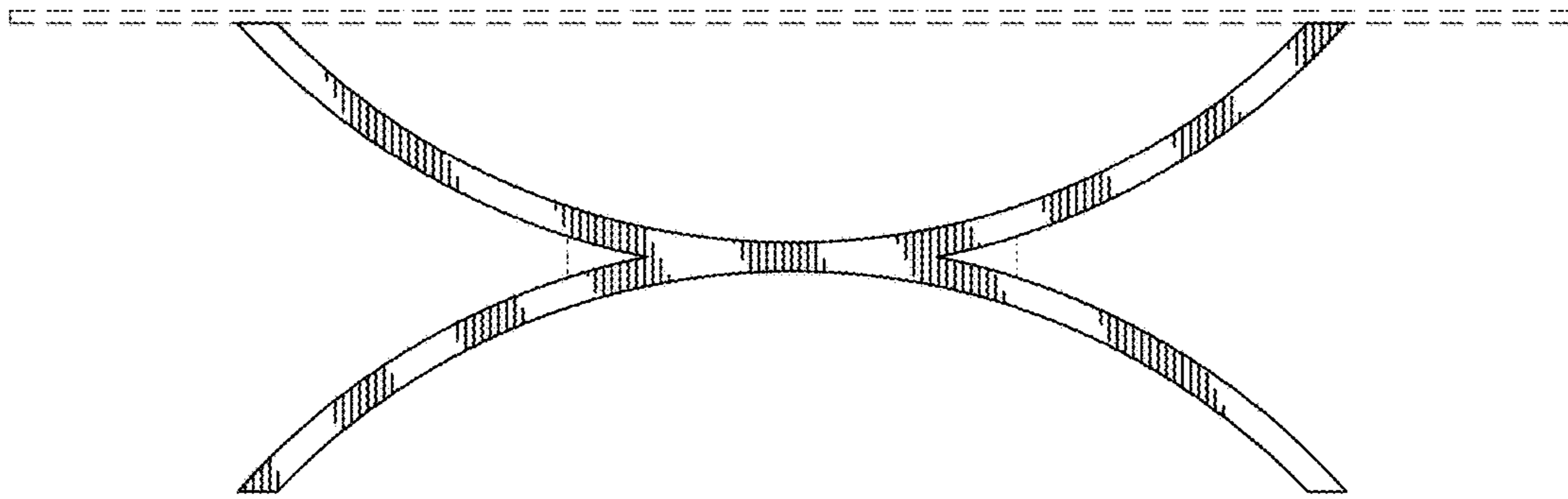

FIG. 5

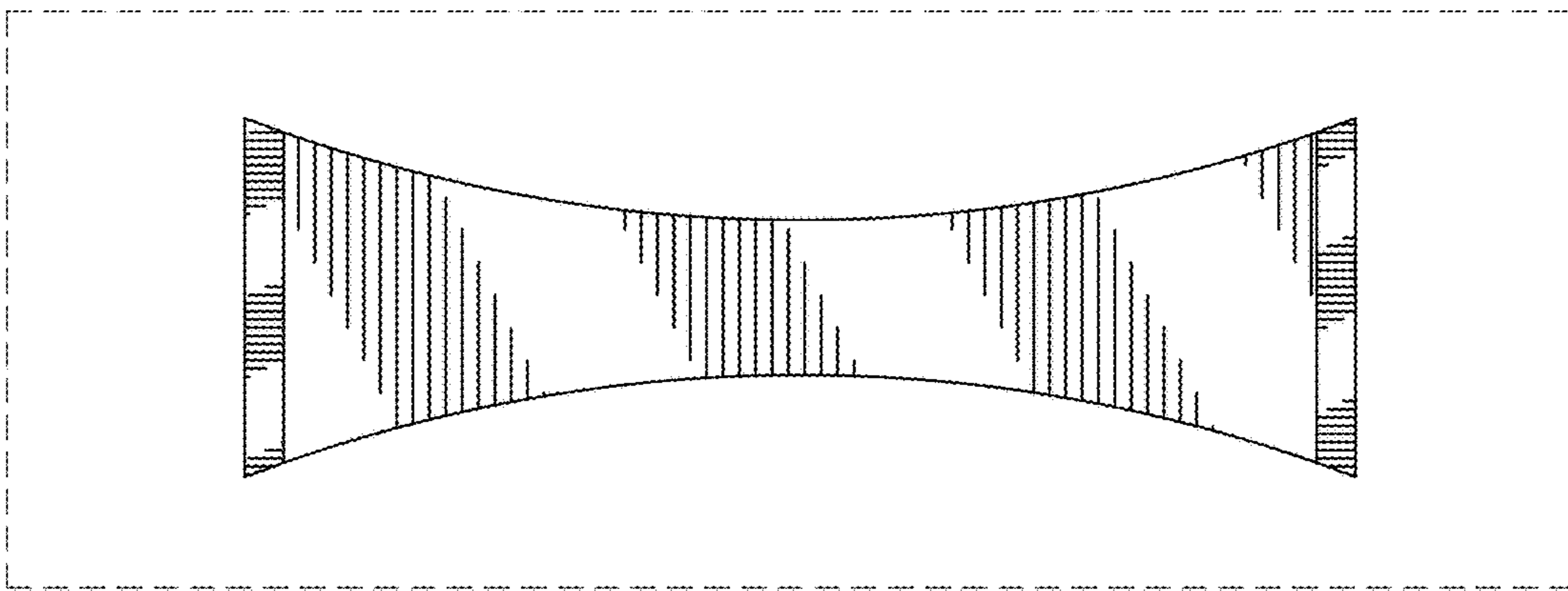

FIG. 6

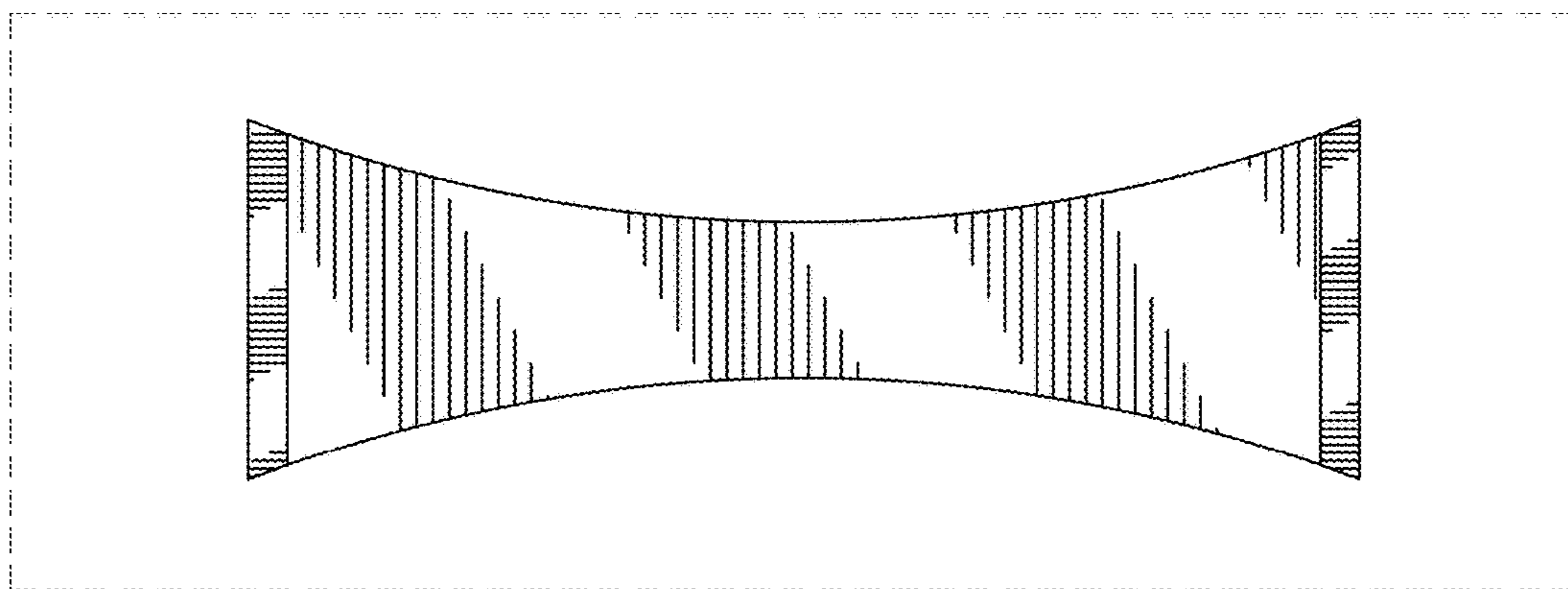

FIG. 7

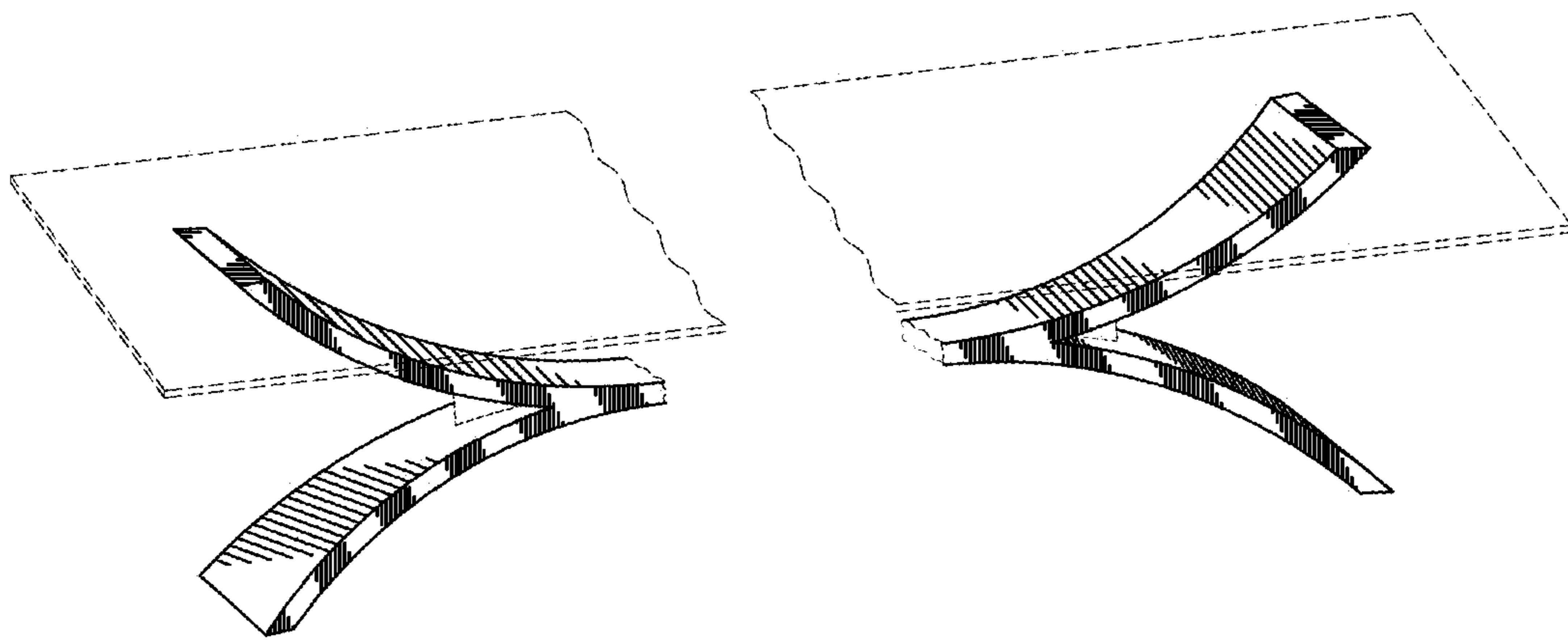

FIG. 8

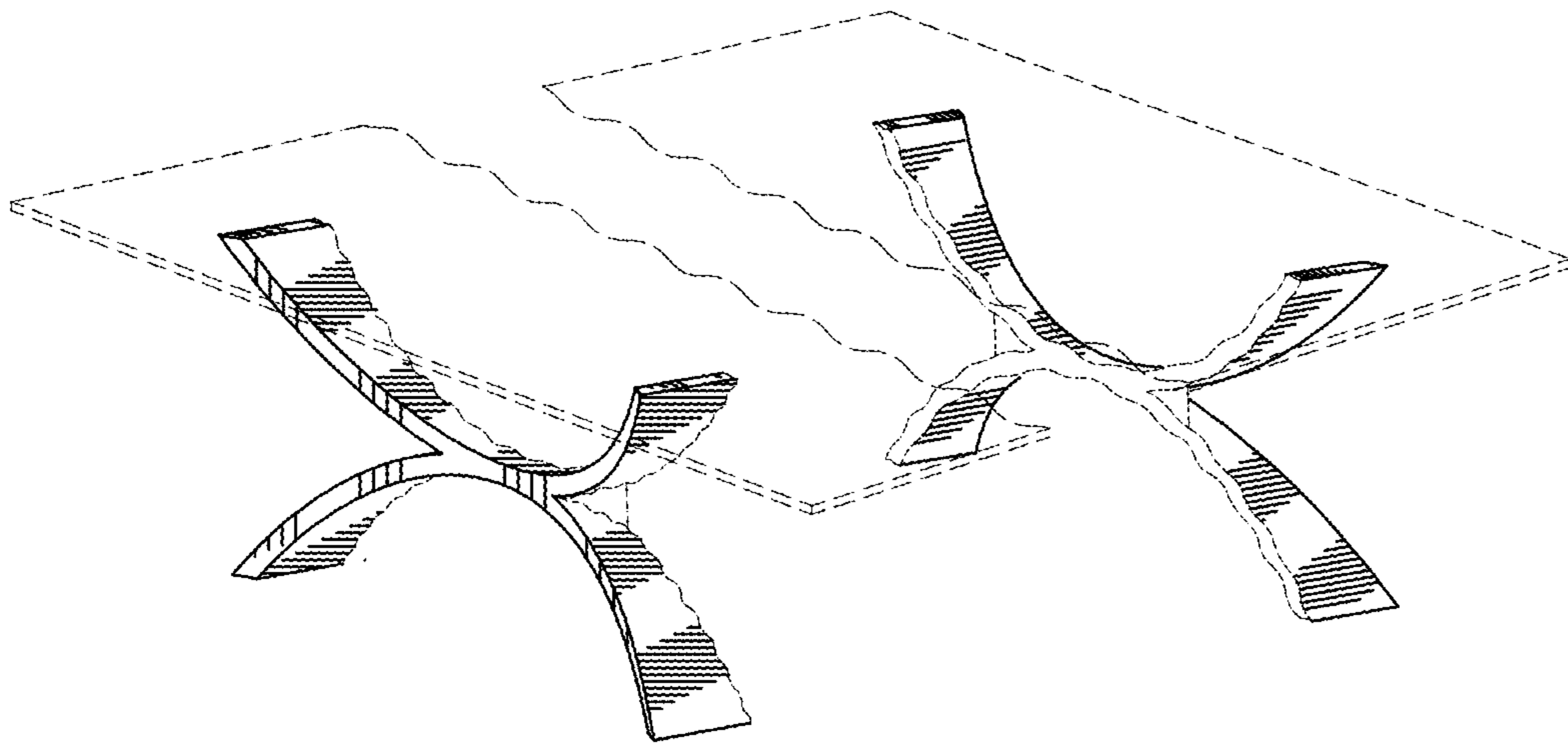

FIG. 9

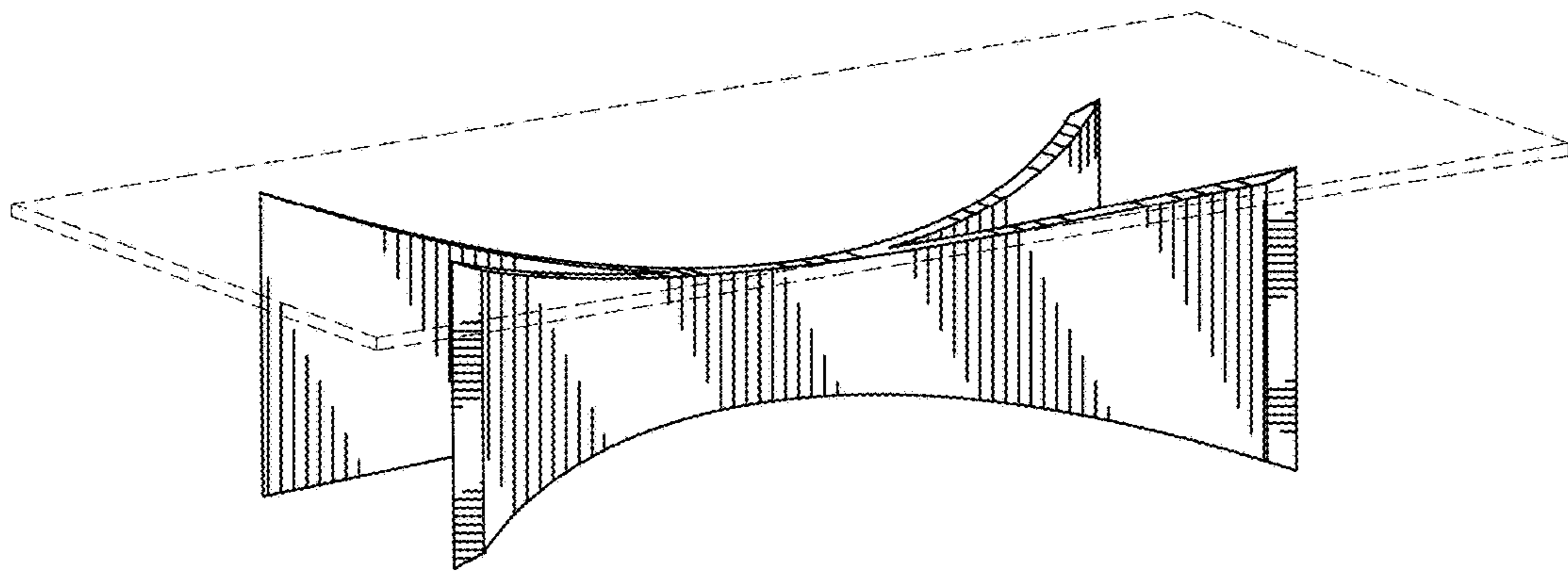

FIG. 10

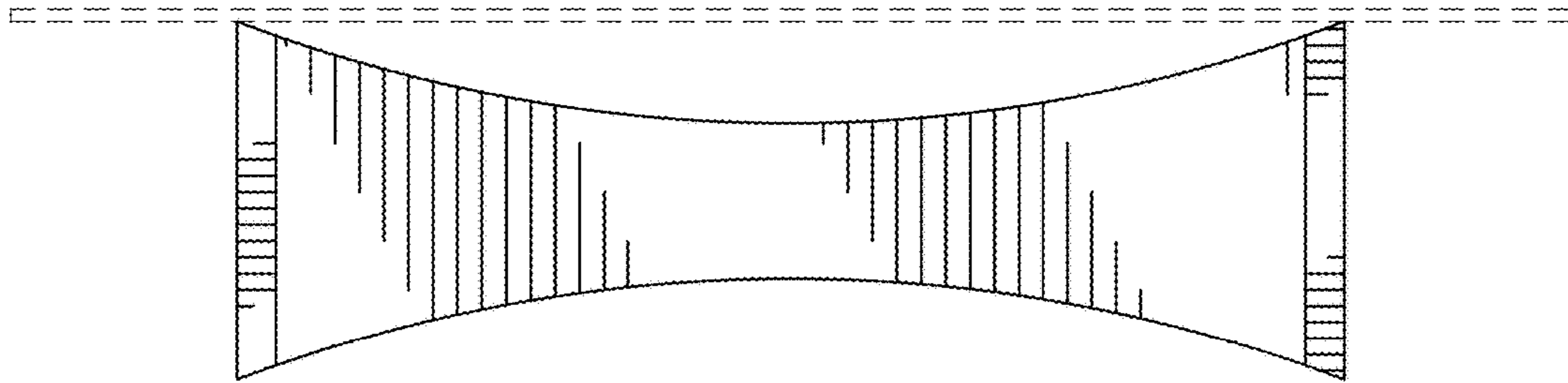

FIG. 11

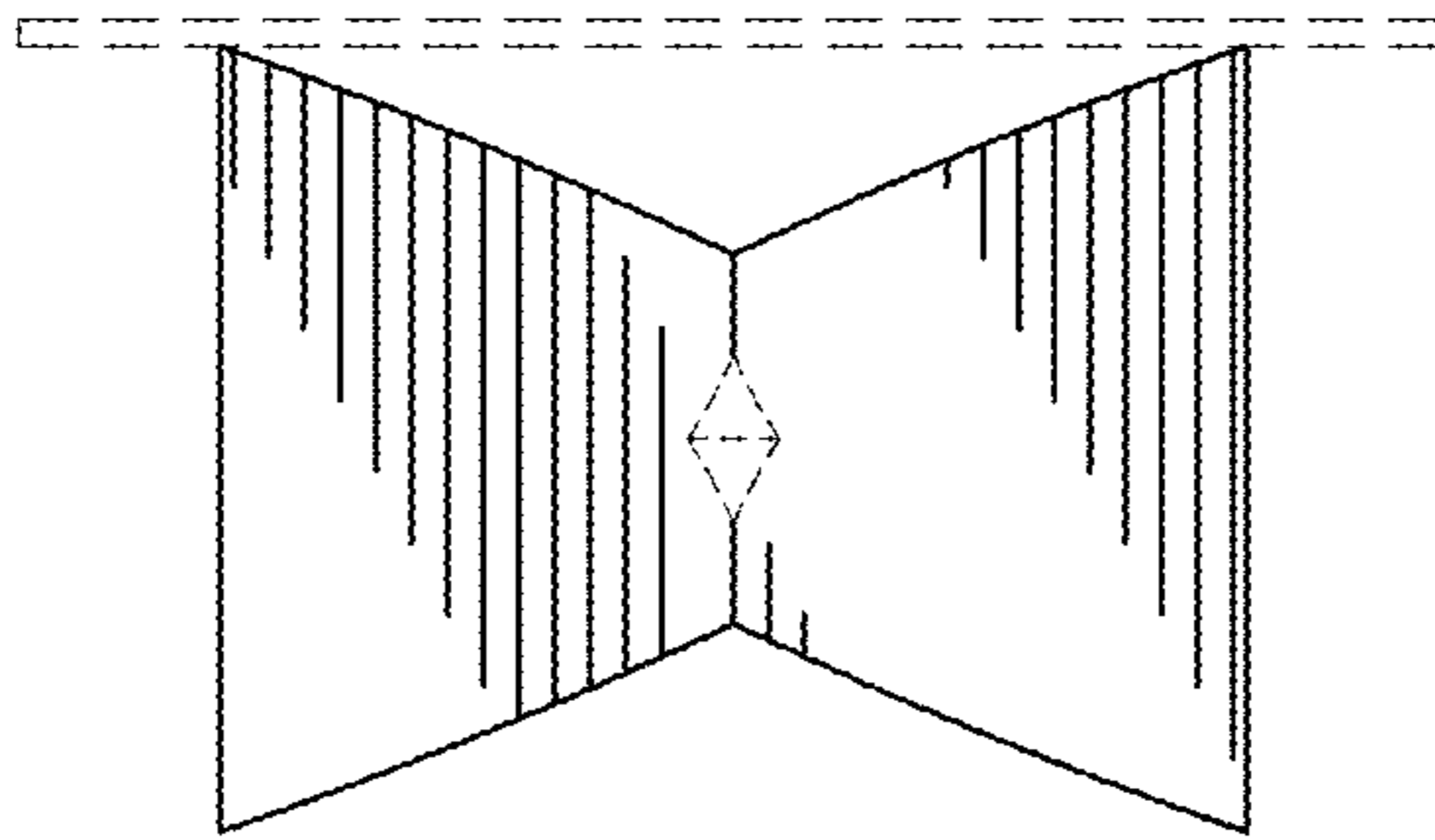

FIG. 12

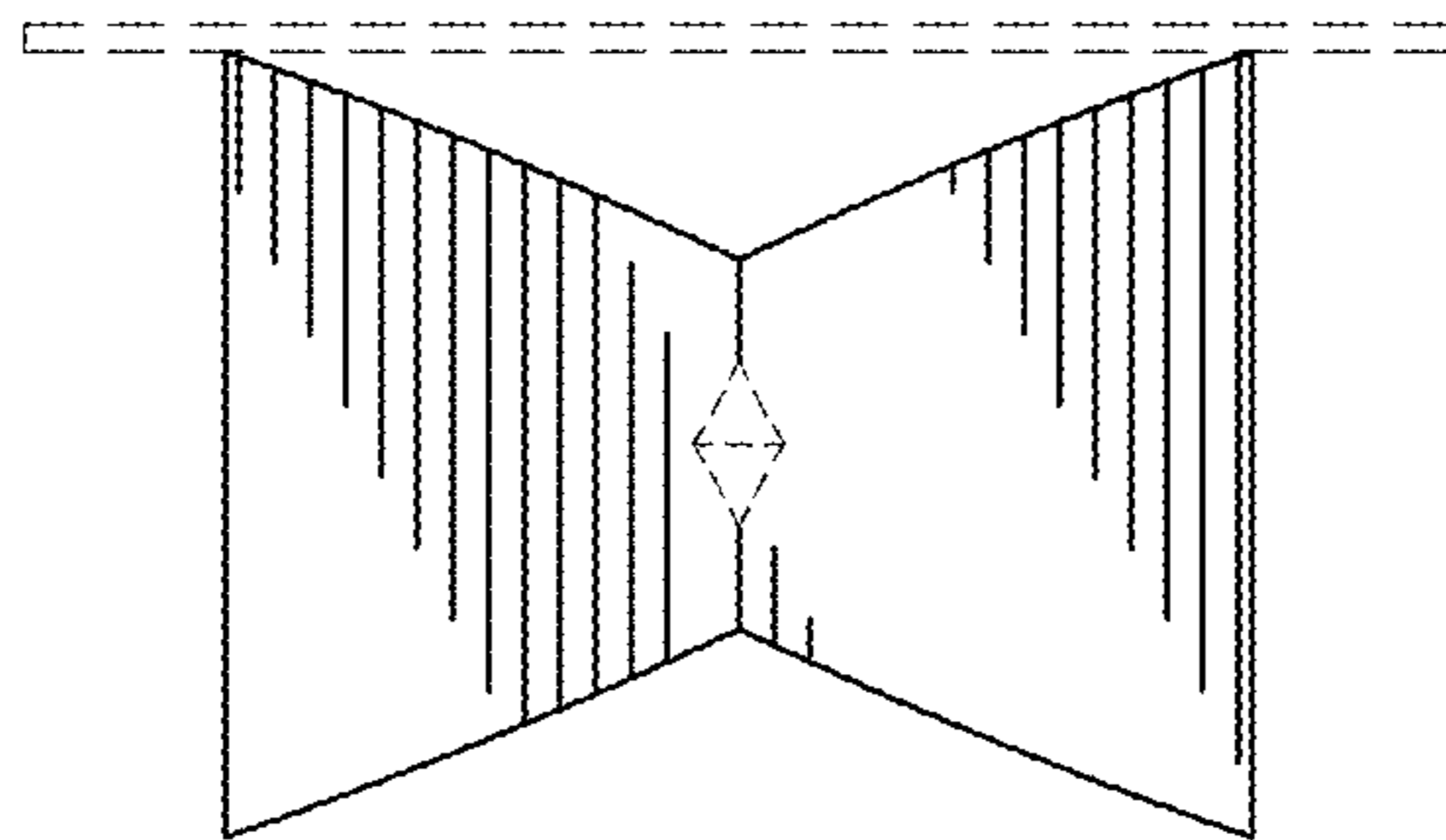

FIG. 13

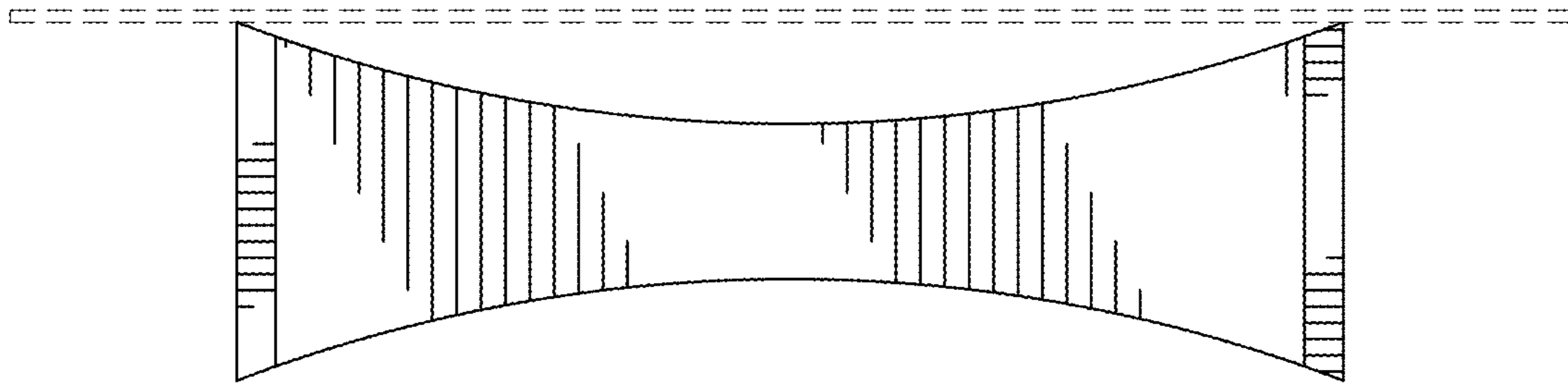

FIG. 14

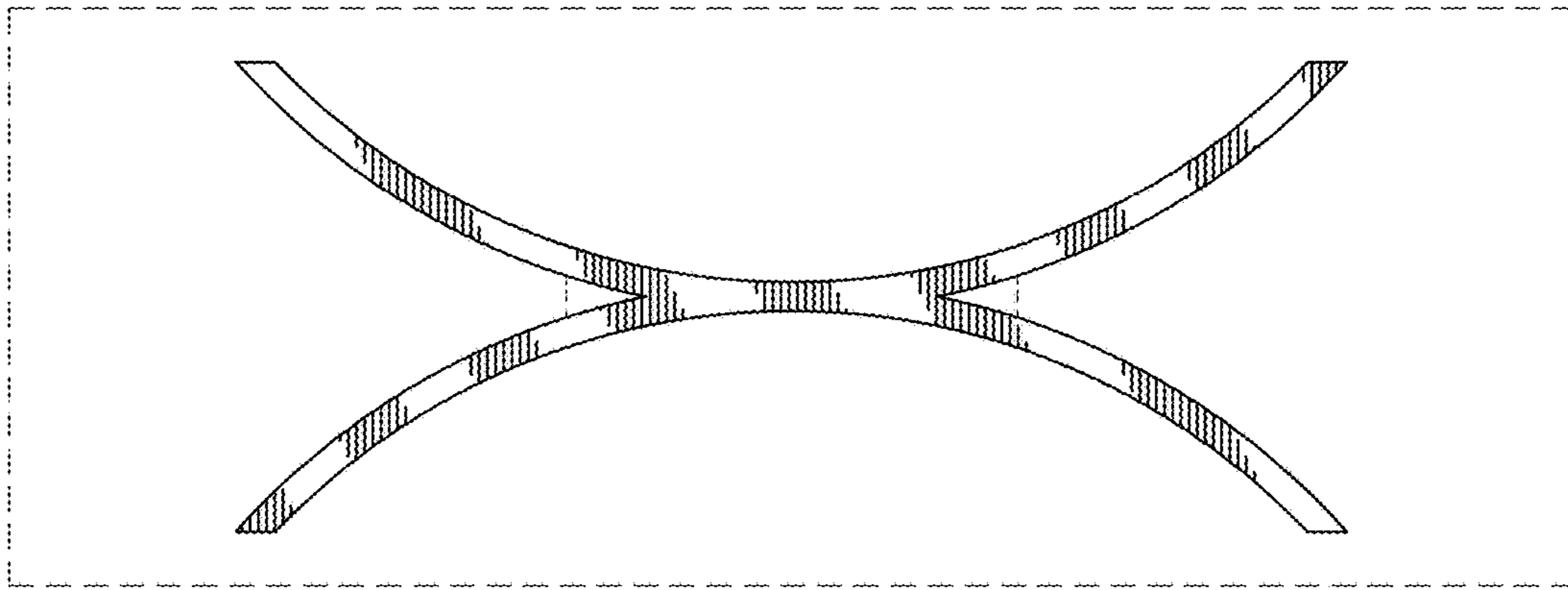

FIG. 15

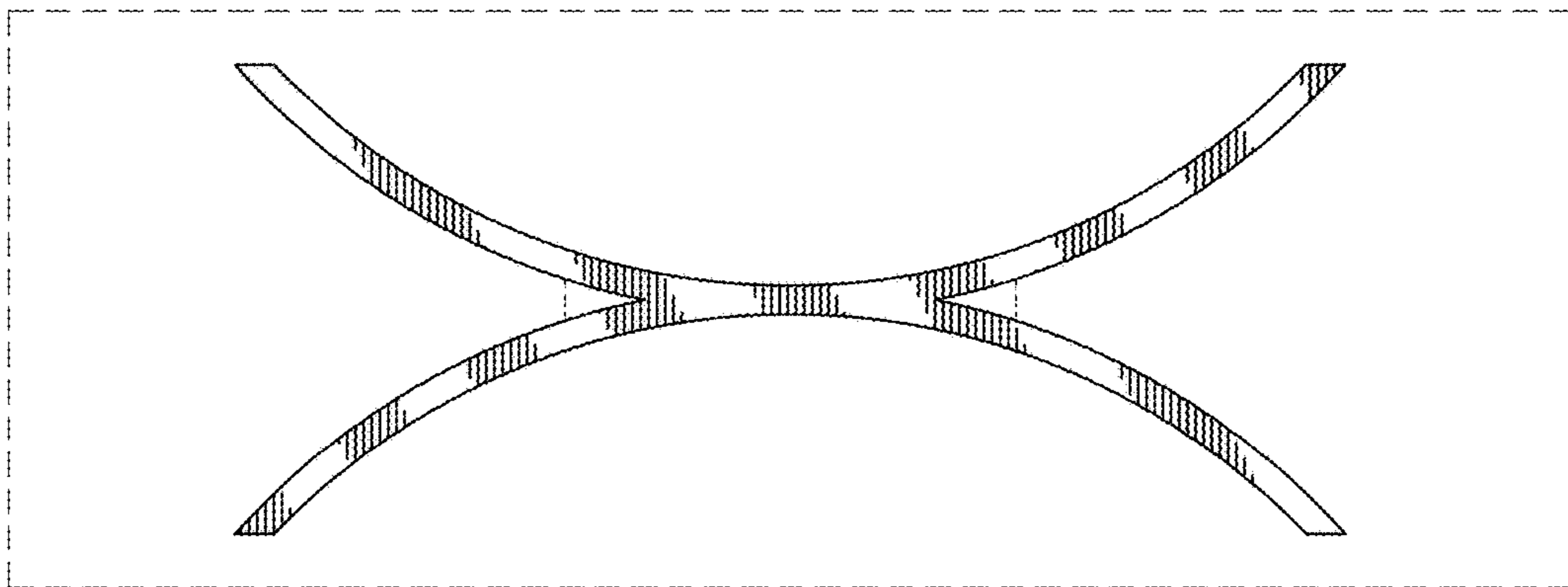

FIG. 16

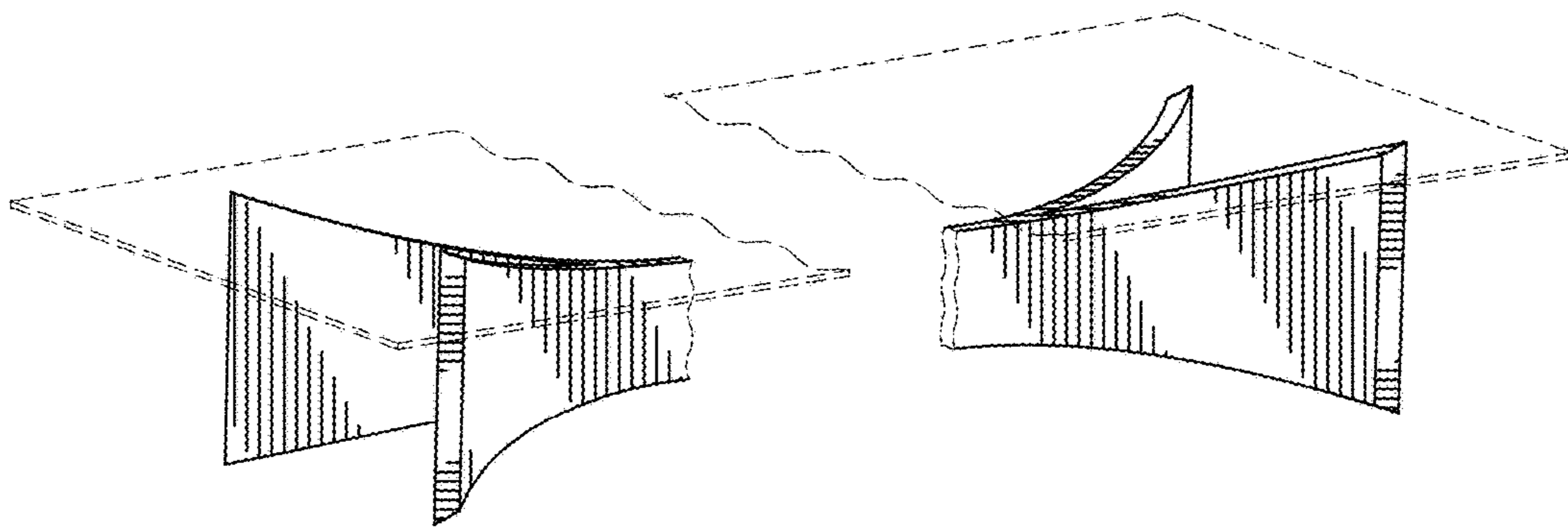

FIG. 17

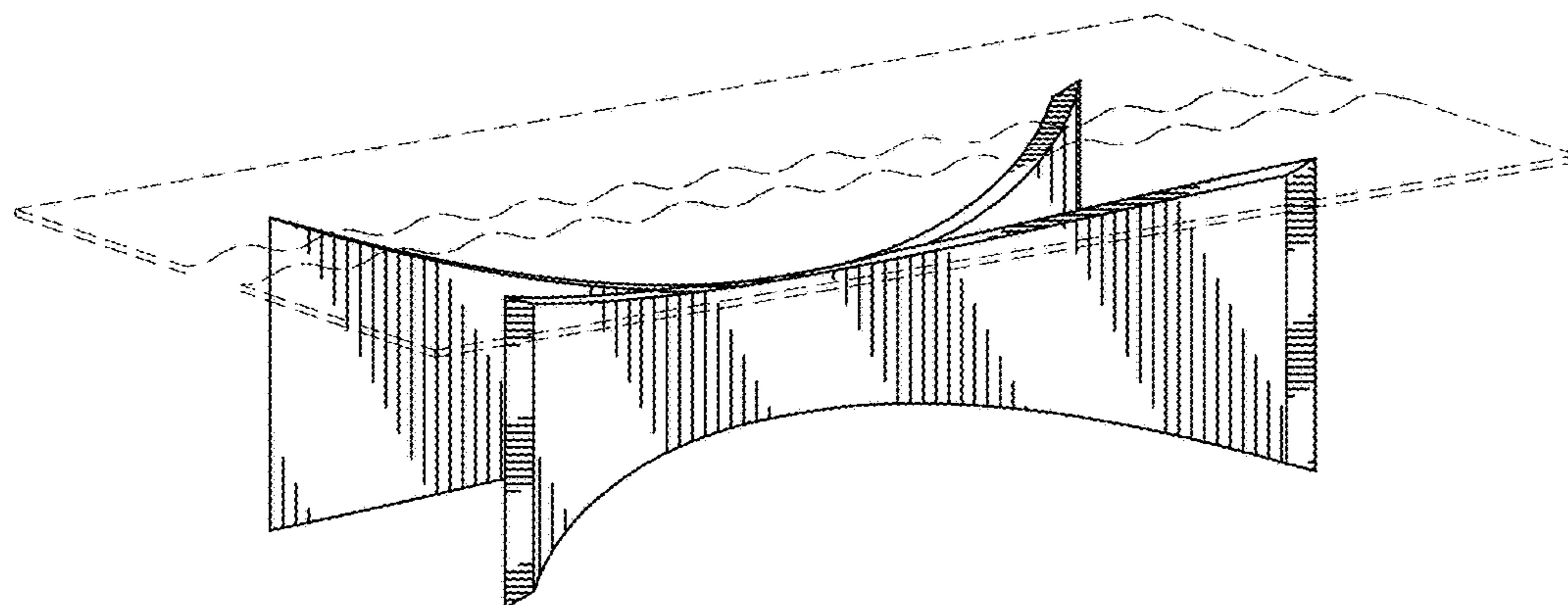

FIG. 18

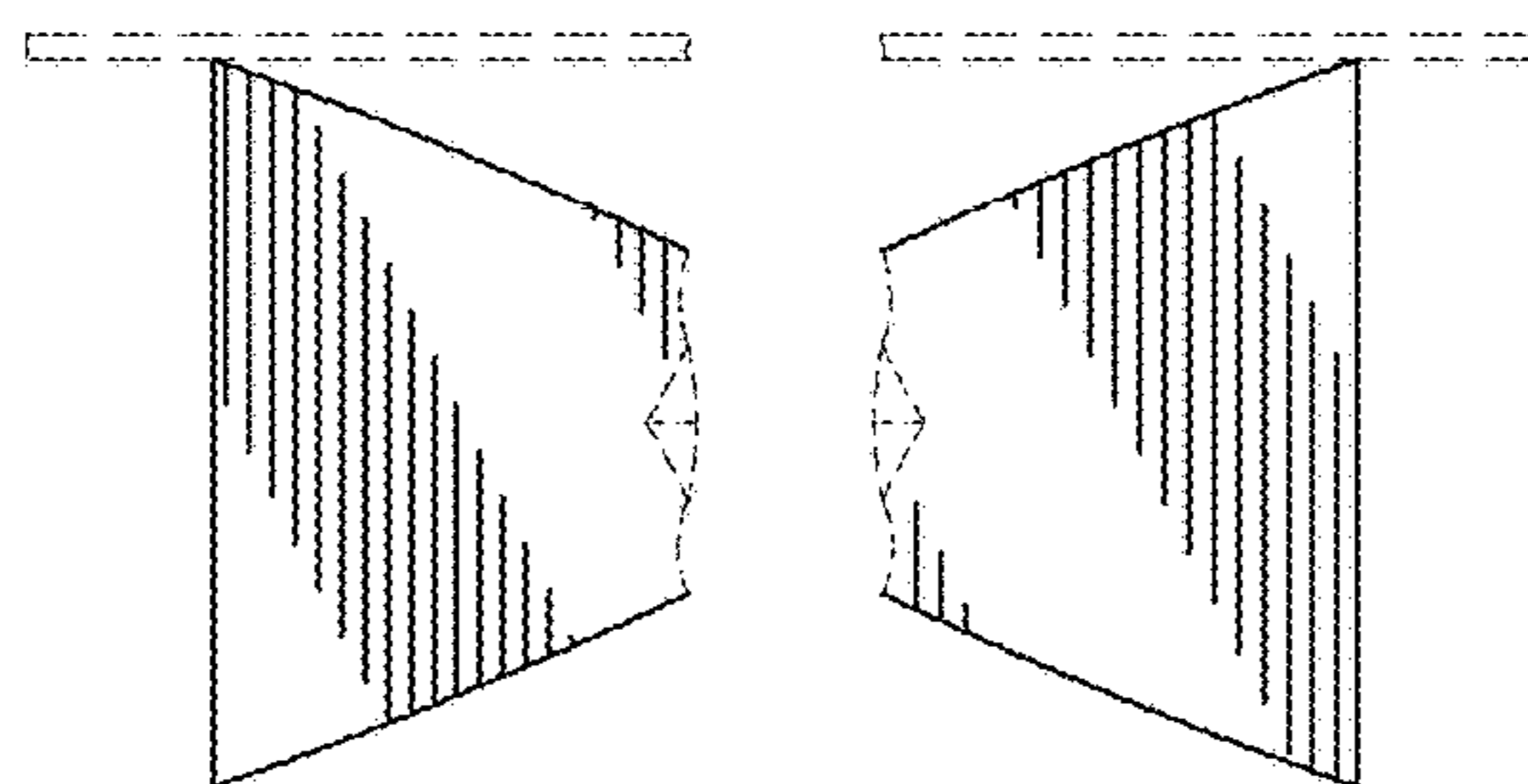

FIG. 19