



US00D781027S

(12) **United States Design Patent**  
**Zheng**

(10) **Patent No.:** **US D781,027 S**  
(45) **Date of Patent:** **\*\* Mar. 14, 2017**

(54) **JACKET**

(71) Applicant: **Qi Zheng**, Vancouver (CA)

(72) Inventor: **Qi Zheng**, Vancouver (CA)

(\*\*) Term: **14 Years**

(21) Appl. No.: **29/525,082**

(22) Filed: **Apr. 27, 2015**

(30) **Foreign Application Priority Data**

Mar. 24, 2015 (CN) ..... 2015 3 0072357

(51) **LOC (10) Cl.** ..... **02-02**

(52) **U.S. Cl.**  
USPC ..... **D2/828**

(58) **Field of Classification Search**

USPC .. D2/828, 829, 831, 839, 87, 830, 750, 840;  
2/84, 108, 93, 96, 85, 97, 905, 69.5, 456,  
2/70, 69, 16

CPC . A41D 3/06; A41D 13/00; A41D 3/00; A41D  
27/04; A41D 1/06; A41D 27/28; A41D  
15/04; A41D 13/001; A41D 27/20; A41D  
13/08; H04R 5/02; A41F 5/00; A42B  
1/048

See application file for complete search history.

(56) **References Cited**

**U.S. PATENT DOCUMENTS**

- 3,389,407 A \* 6/1968 Morrison ..... A41D 3/06  
2/84
- D243,723 S \* 3/1977 Schaefer ..... D2/829
- 4,646,366 A \* 3/1987 Nishida ..... A41D 13/00  
2/108
- D338,773 S \* 8/1993 Wilde ..... D2/831
- D374,329 S \* 10/1996 Wilde ..... D2/828

(Continued)

**FOREIGN PATENT DOCUMENTS**

- JP D1203602 \* 4/2004
- JP D1220383 \* 10/2004
- JP D 1250735 \* 9/2005

**OTHER PUBLICATIONS**

Nike Sweatless Hooded jacket—6PM, Announced Jan. 17, 2013, [ Site Visited Feb. 12, 2016 ]<http://www.6pm.com/nike-sweatless-hooded-jacket>.\*

(Continued)

*Primary Examiner* — Kevin Rudzinski

(74) *Attorney, Agent, or Firm* — Jen-Feng Lee, Esq.

(57) **CLAIM**

I claim the ornamental design for a jacket, as shown and described.

**DESCRIPTION**

FIG. 1 is a front view of a jacket with the hood raised showing my new design,  
 FIG. 2 is a rear view thereof,  
 FIG. 3 is a left-side view thereof,  
 FIG. 4 is a right-side view thereof,  
 FIG. 5 is a top view thereof,  
 FIG. 6 is a bottom view thereof,  
 FIG. 7 is a front view thereof, with no hood,  
 FIG. 8 is a rear view thereof, with no hood,  
 FIG. 9 is a left-side view thereof, with no hood,  
 FIG. 10 is a right-side view thereof, with no hood,  
 FIG. 11 is a top view thereof, with no hood; and,  
 FIG. 12 is a bottom view thereof, with no hood.  
 The broken lines shown in the drawings illustrate portions of the jacket that form no part of the claimed design.

**1 Claim, 8 Drawing Sheets**

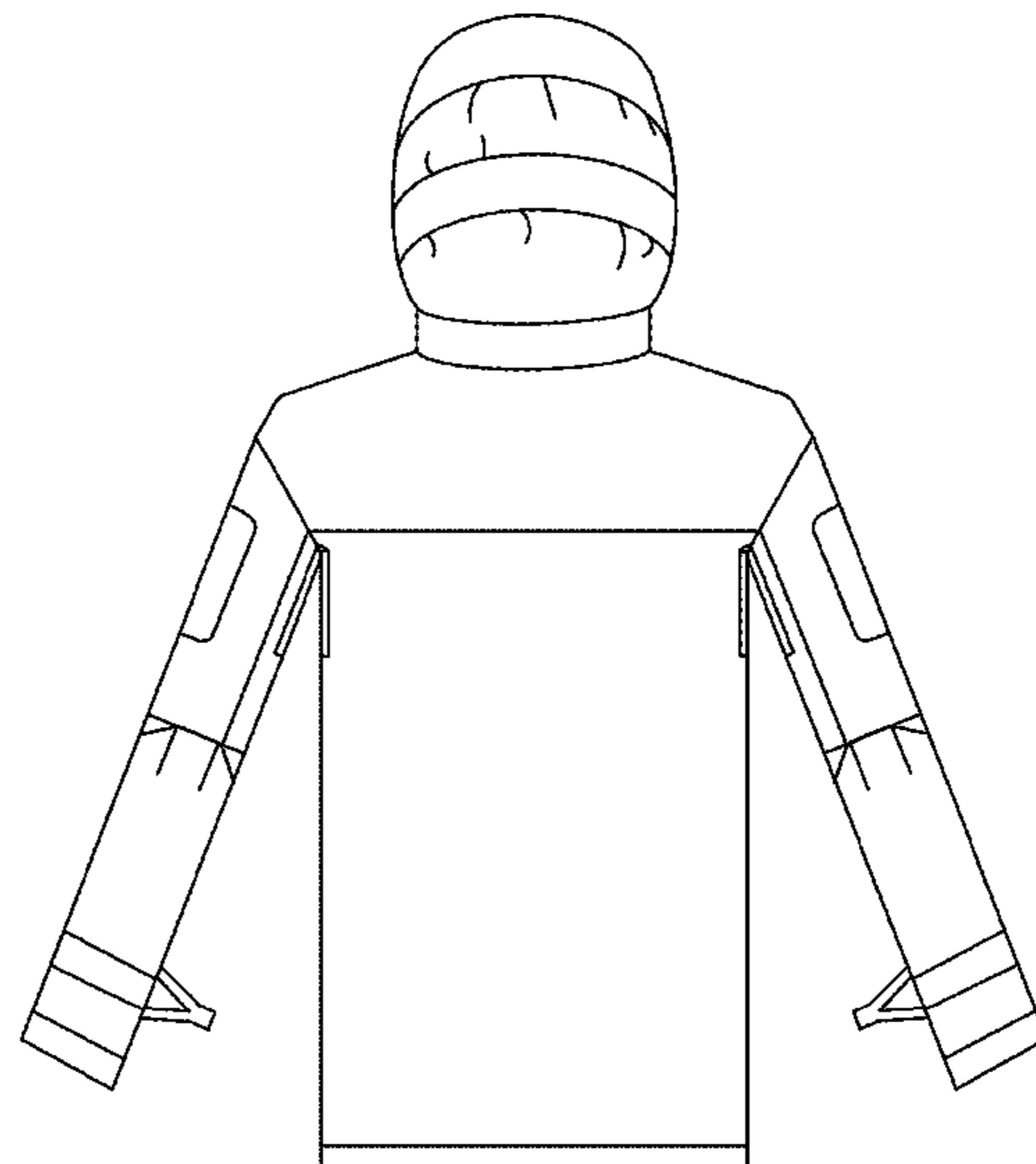
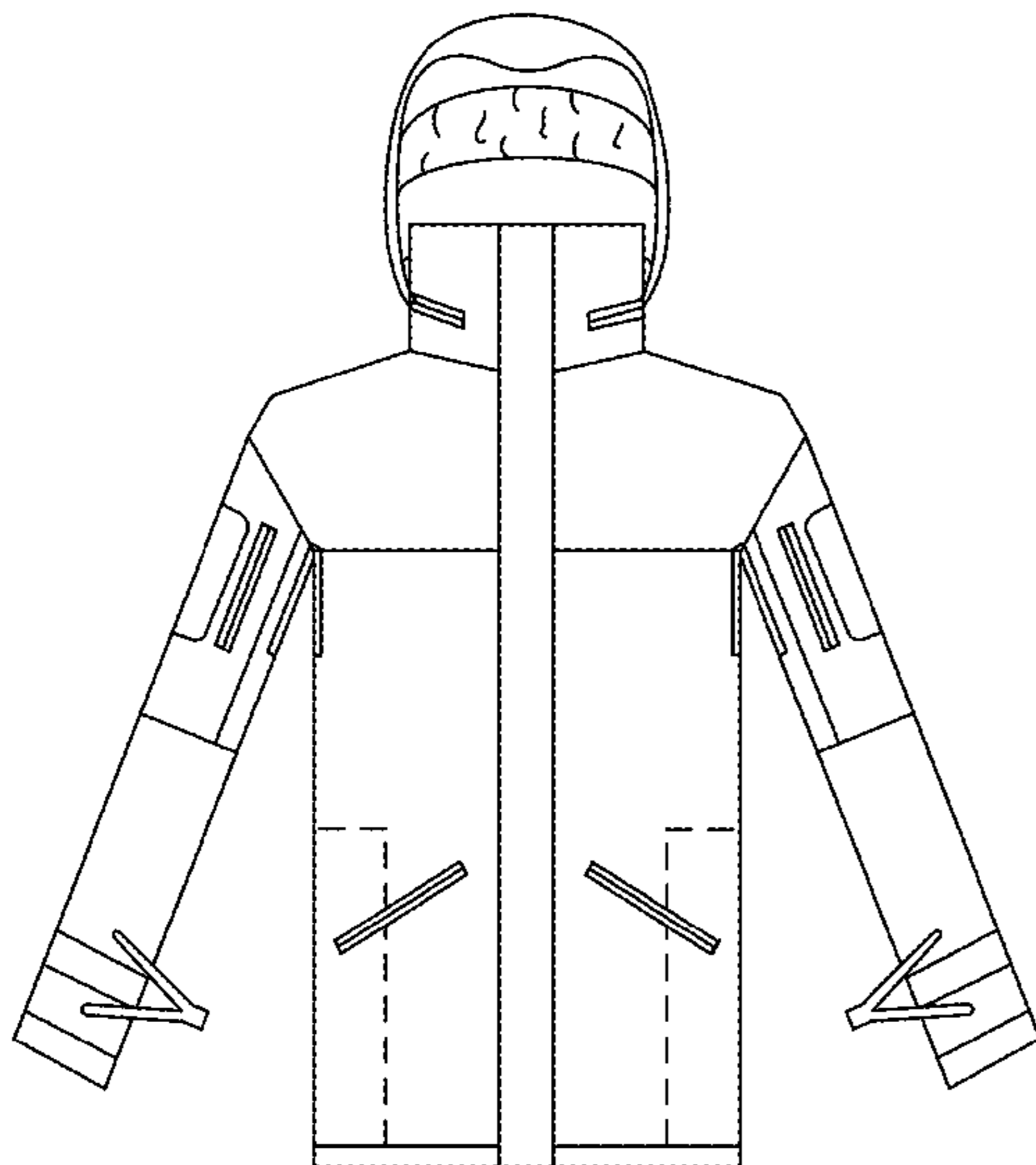

(56)

References Cited

U.S. PATENT DOCUMENTS

6,119,270 A \* 9/2000 Chou ..... A41D 3/00  
2/108  
D479,902 S \* 9/2003 Brown ..... D2/831  
6,654,963 B2 \* 12/2003 Fayle ..... A41D 3/00  
2/84  
D527,868 S \* 9/2006 Wager ..... D2/828  
D529,687 S \* 10/2006 Rindle ..... D2/828  
7,284,282 B2 \* 10/2007 Bay ..... A41D 3/00  
2/85  
D580,631 S \* 11/2008 Adams ..... D2/839  
D588,783 S \* 3/2009 Olstorn ..... D2/828  
7,684,755 B2 \* 3/2010 Pierce ..... H04R 5/02  
2/905  
D622,937 S \* 9/2010 Bay ..... D2/830  
D627,950 S \* 11/2010 Carpentier ..... D2/750  
D638,201 S \* 5/2011 Gosse ..... D2/831  
D638,202 S \* 5/2011 Gosse ..... D2/831  
D654,664 S \* 2/2012 Evans ..... D2/839  
D662,282 S \* 6/2012 Meunier-Bouchard ..... D2/828  
D662,284 S \* 6/2012 Lam ..... D2/831  
D665,152 S \* 8/2012 Morales ..... D2/840  
D685,160 S \* 7/2013 Savage ..... D2/831  
D693,990 S \* 11/2013 Farron ..... D2/839  
D694,992 S \* 12/2013 Farron ..... D2/828  
8,661,563 B2 \* 3/2014 Evans ..... A41D 13/08  
2/16  
D704,924 S \* 5/2014 Roberts ..... D2/831  
D714,525 S \* 10/2014 Payne ..... D2/828

D714,527 S \* 10/2014 Borovicka ..... D2/839  
2003/0051286 A1 \* 3/2003 Gregg ..... A41D 27/10  
2/93  
2004/0055069 A1 \* 3/2004 Clarke Fayle ..... A41D 3/00  
2/93  
2004/0143884 A1 \* 7/2004 Majerfeld ..... A41D 27/04  
2/96  
2008/0184454 A1 \* 8/2008 Collier ..... A41D 1/06  
2/93  
2009/0077710 A1 \* 3/2009 Bay ..... A41D 27/28  
2/87  
2009/0249529 A1 \* 10/2009 Rodriguez ..... A41D 3/00  
2/97  
2011/0088135 A1 \* 4/2011 Snyder ..... A41D 15/04  
2/69.5  
2012/0005812 A1 \* 1/2012 Corzatt ..... A41D 13/001  
2/456  
2012/0204313 A1 \* 8/2012 Evans ..... A41F 5/00  
2/70  
2013/0042384 A1 \* 2/2013 Mitchell ..... A42B 1/048  
2/84  
2013/0219581 A1 \* 8/2013 Schrimpf ..... A41D 27/20  
2/69

OTHER PUBLICATIONS

Nike Silver Super Bowl XLVIII Collection, Announced Jan. 9, 2014, [ Site Visited Feb. 12, 2016 ] <http://kicksaddict.com/2014/01/09/nike-silver-speed-super-bowl-xlviiii-collection/>.\*

\* cited by examiner

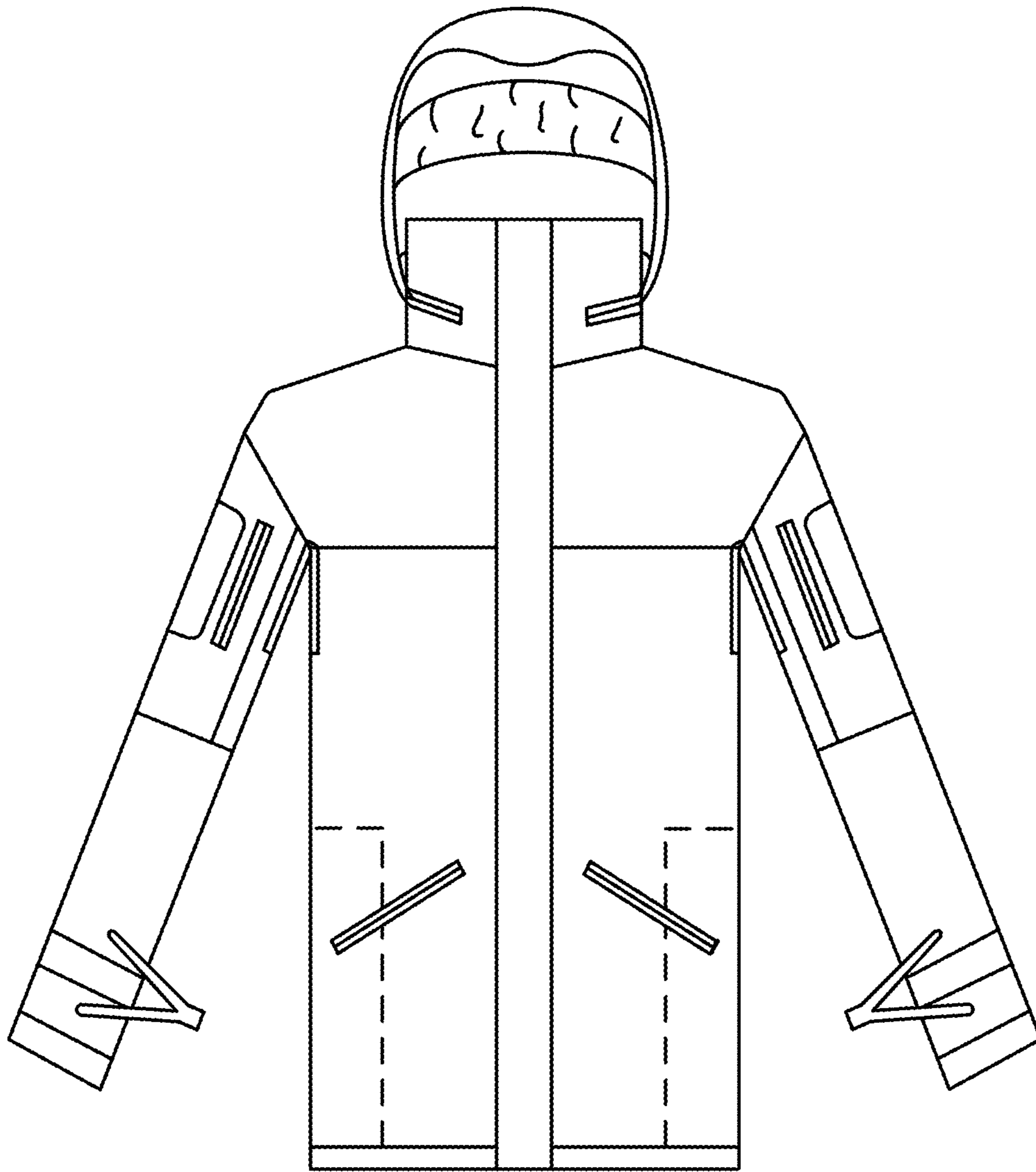

FIG. 1

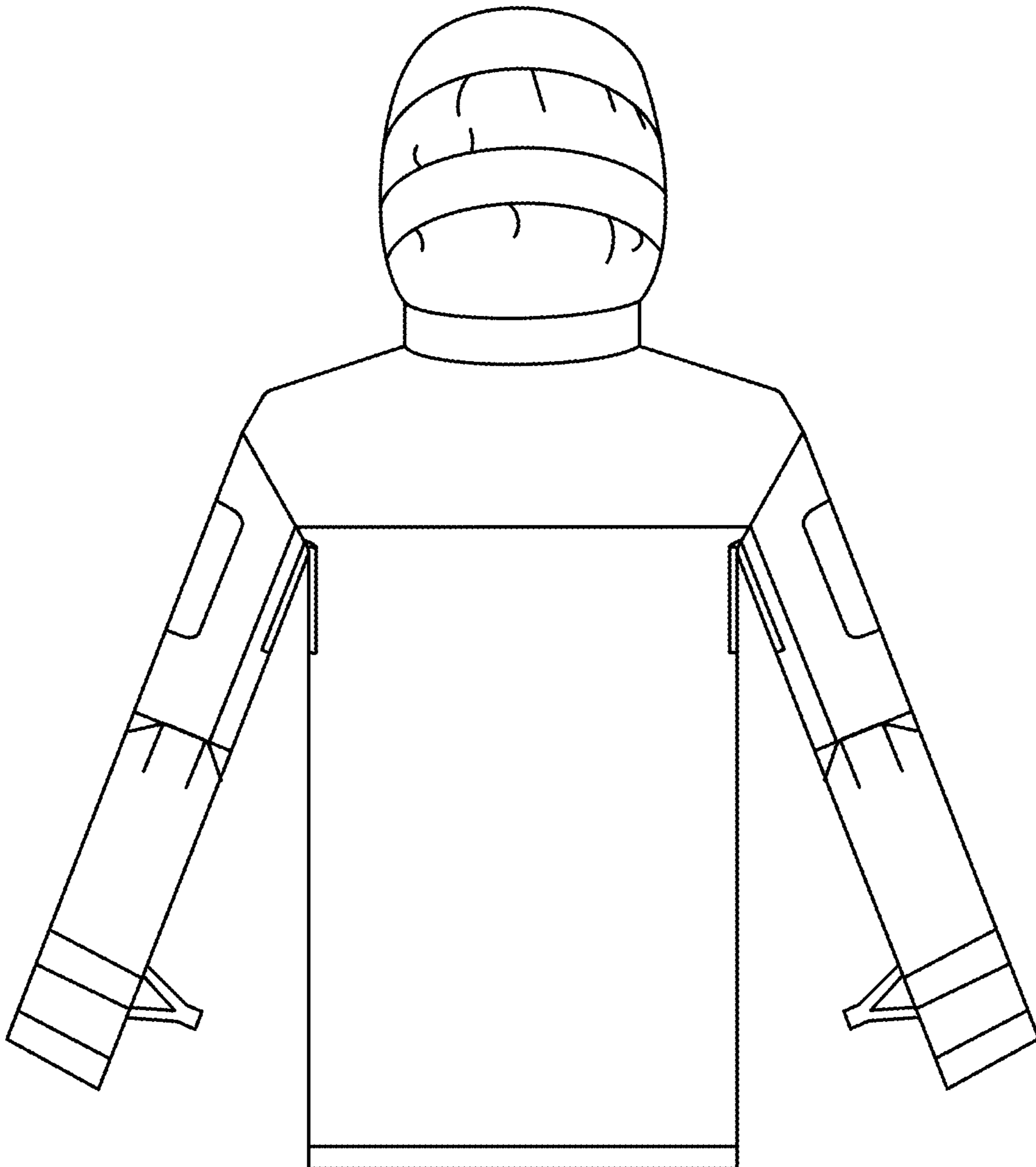

FIG. 2

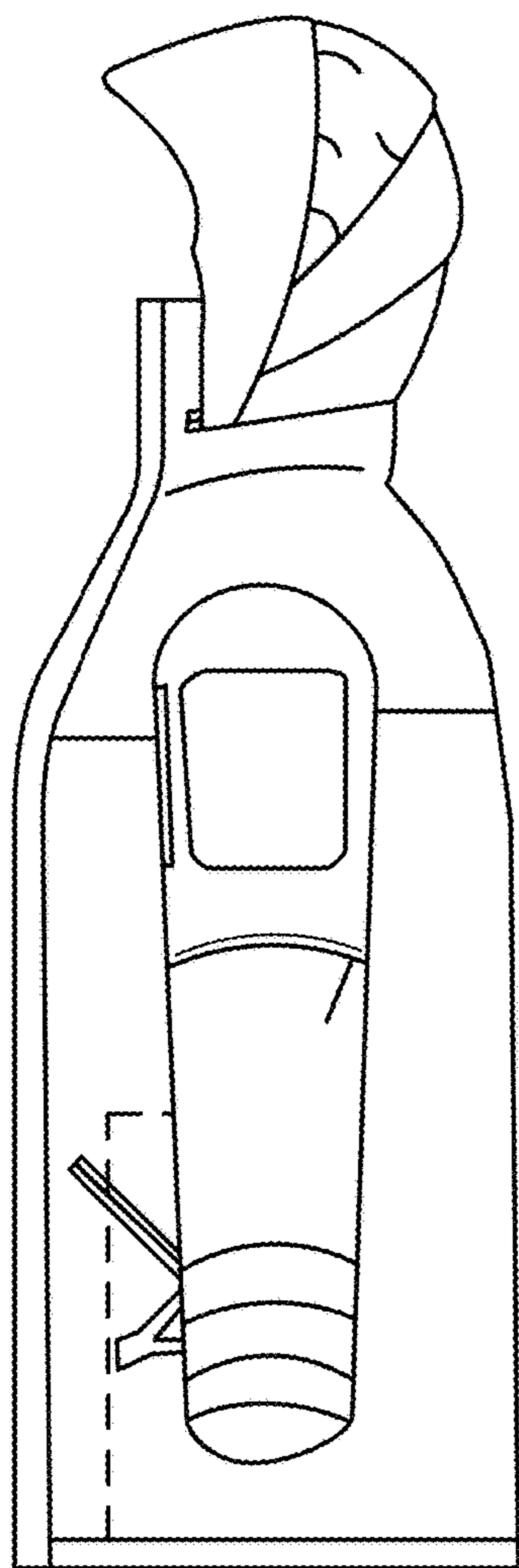

FIG. 3

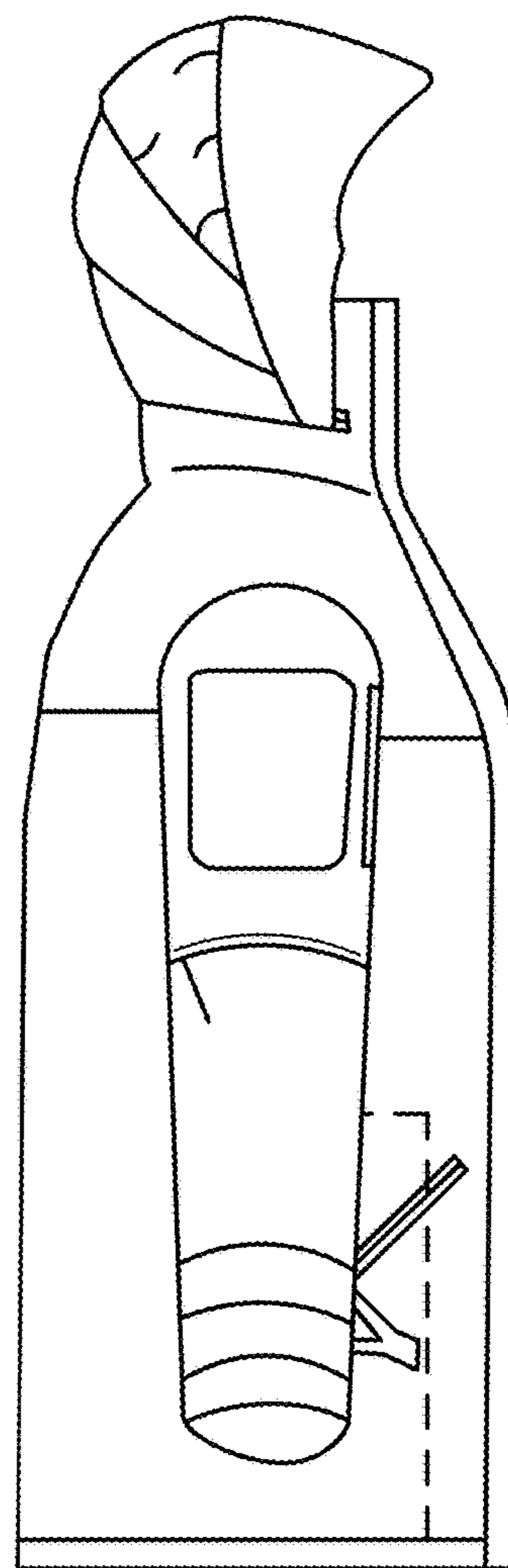

FIG. 4

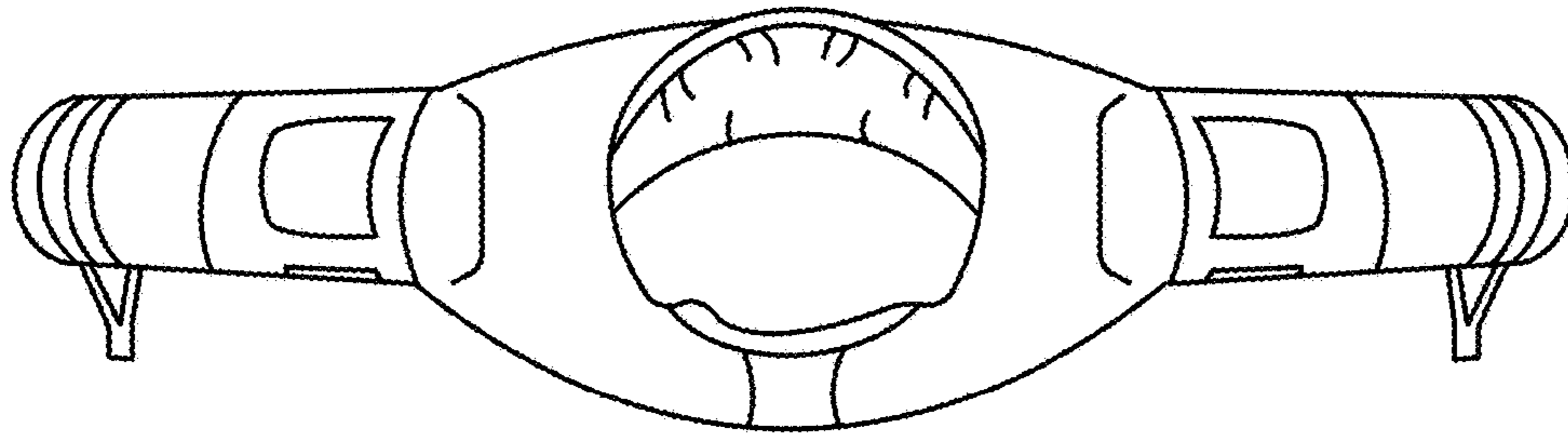

FIG. 5

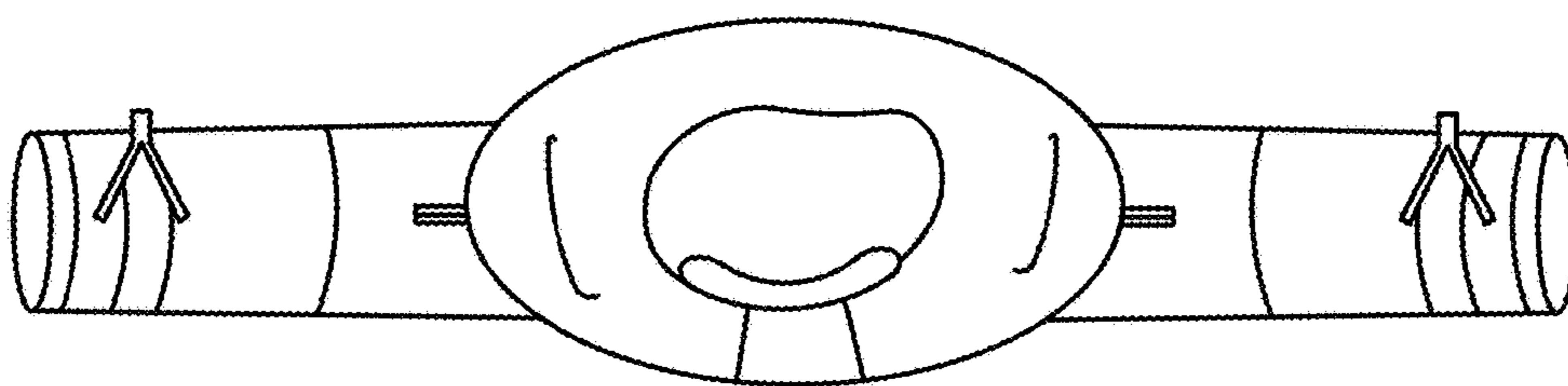

FIG. 6

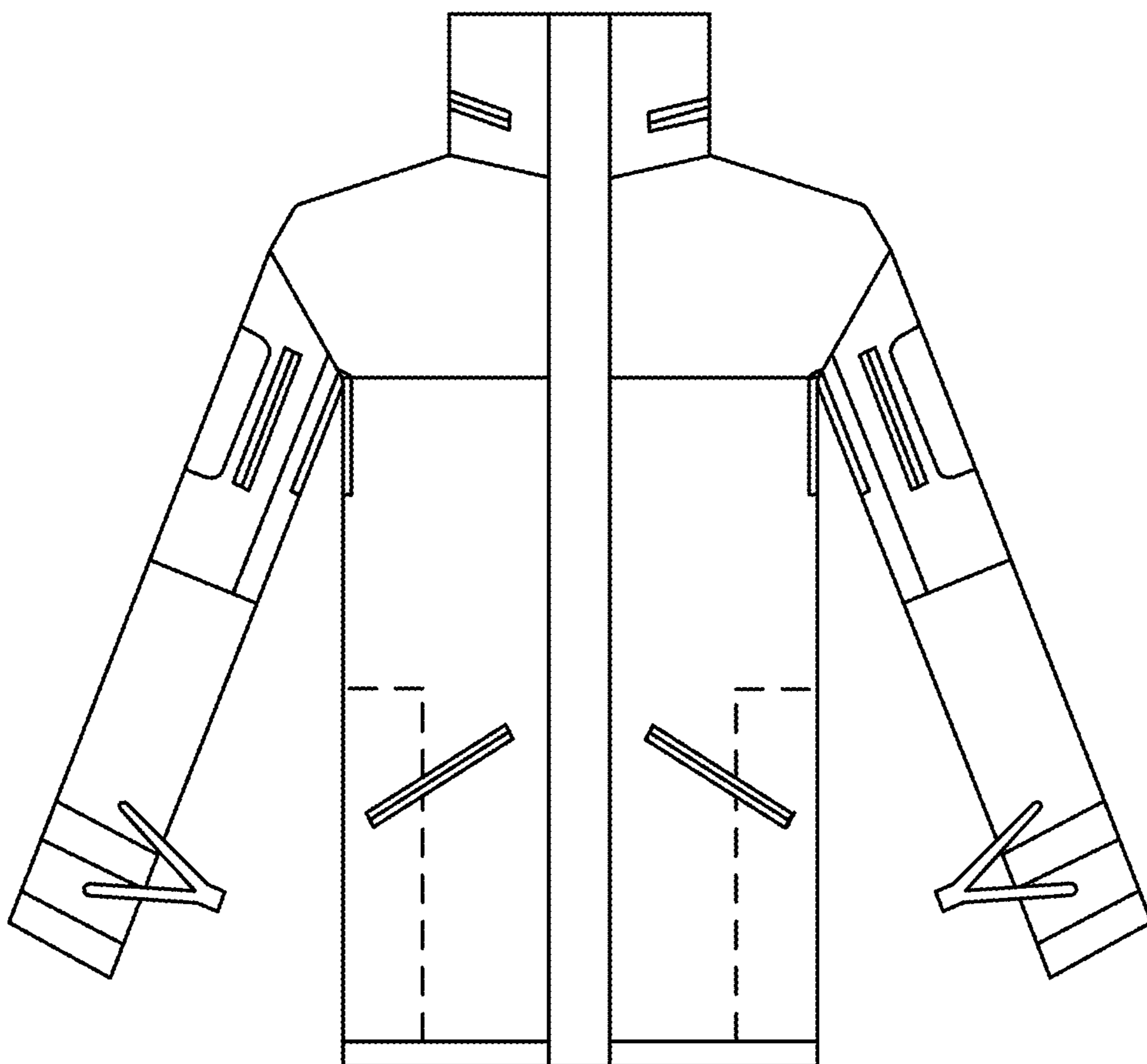

FIG. 7

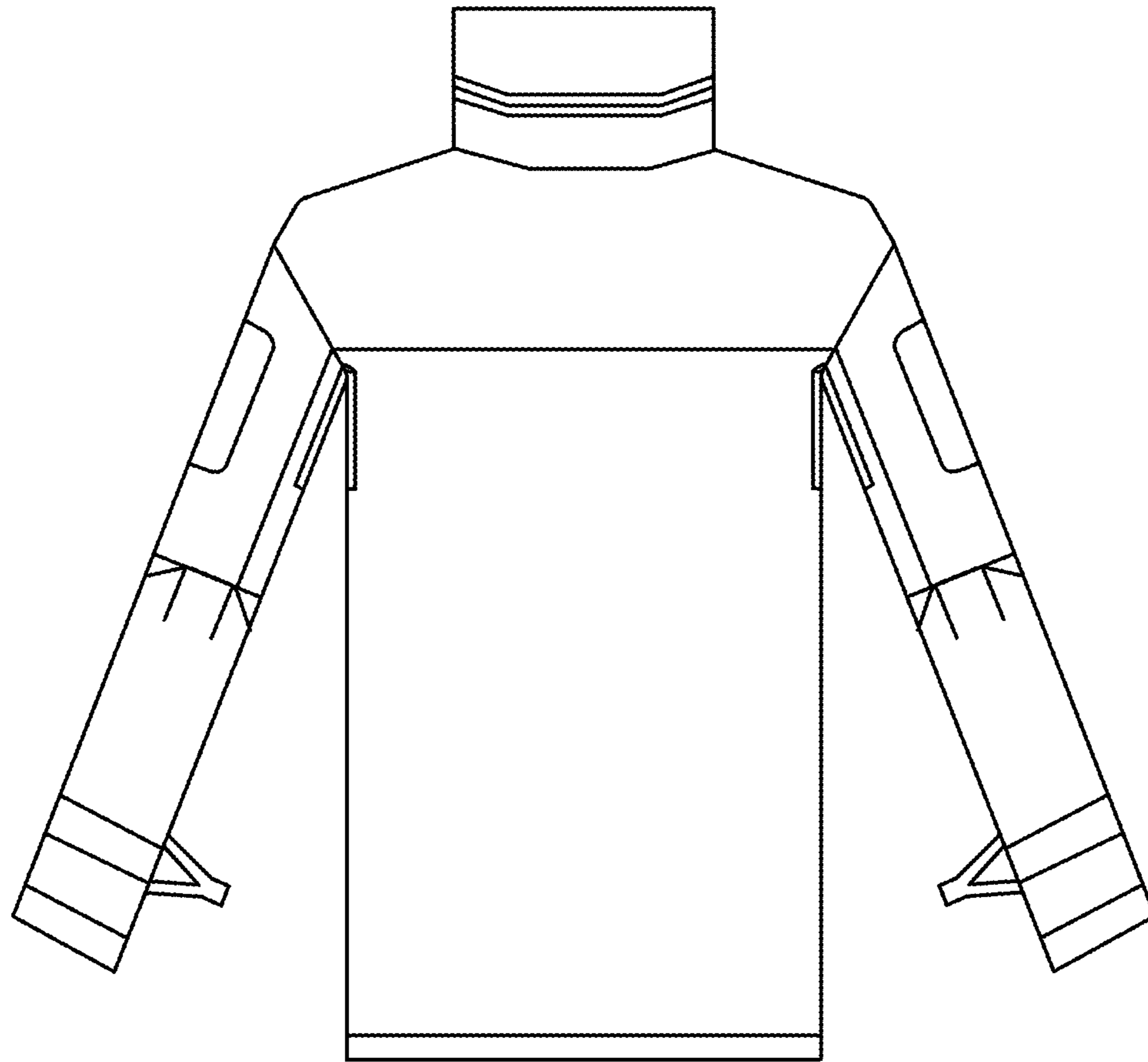

FIG. 8



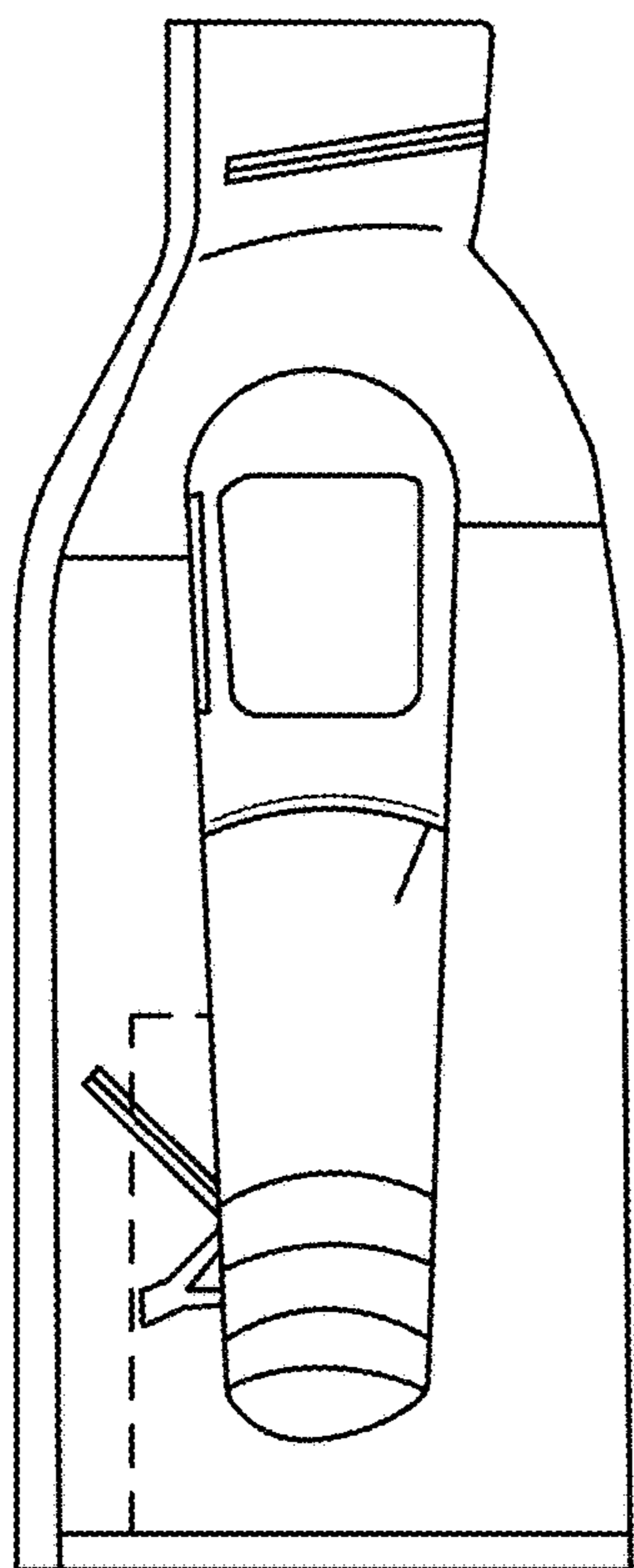

FIG. 9

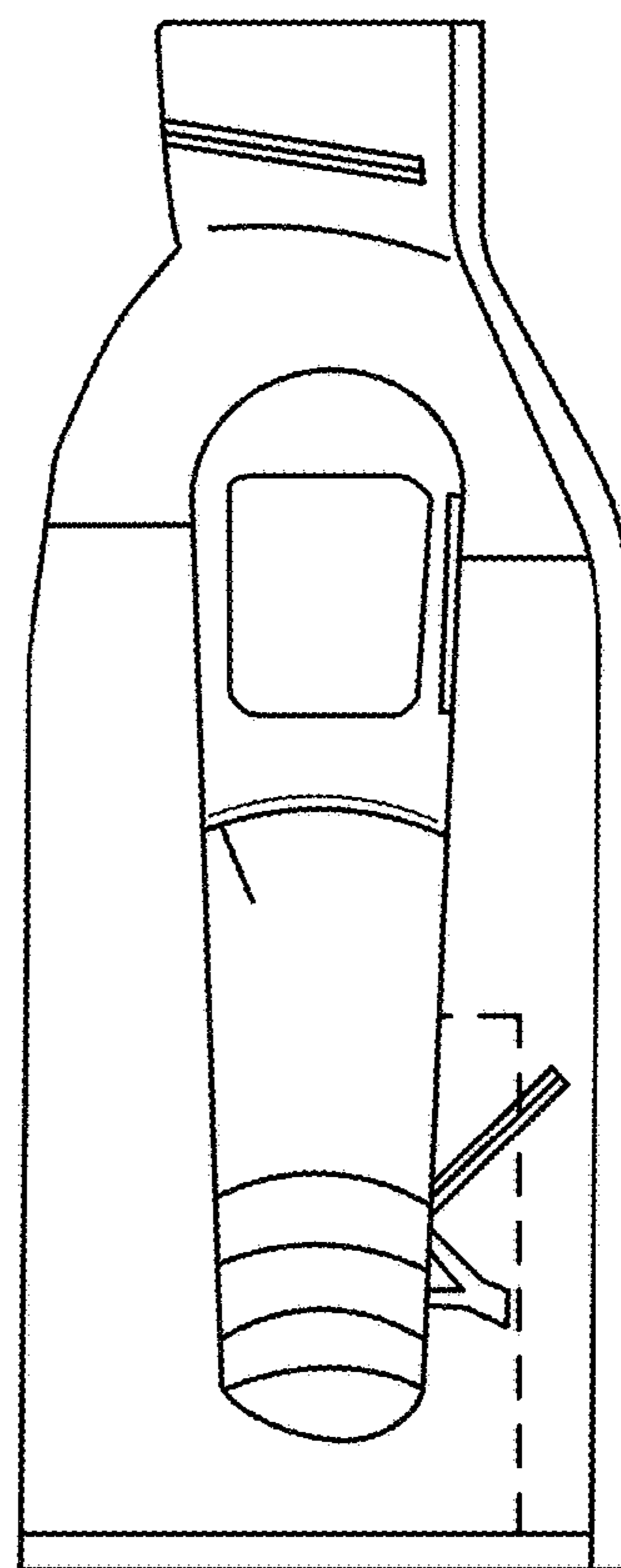

FIG. 10

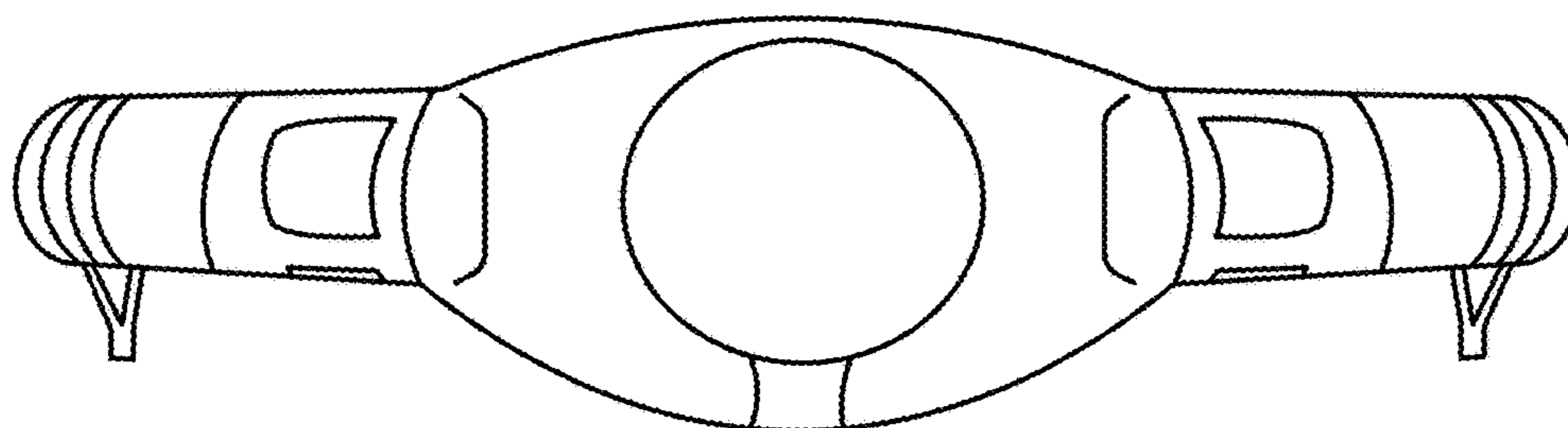

FIG. 11

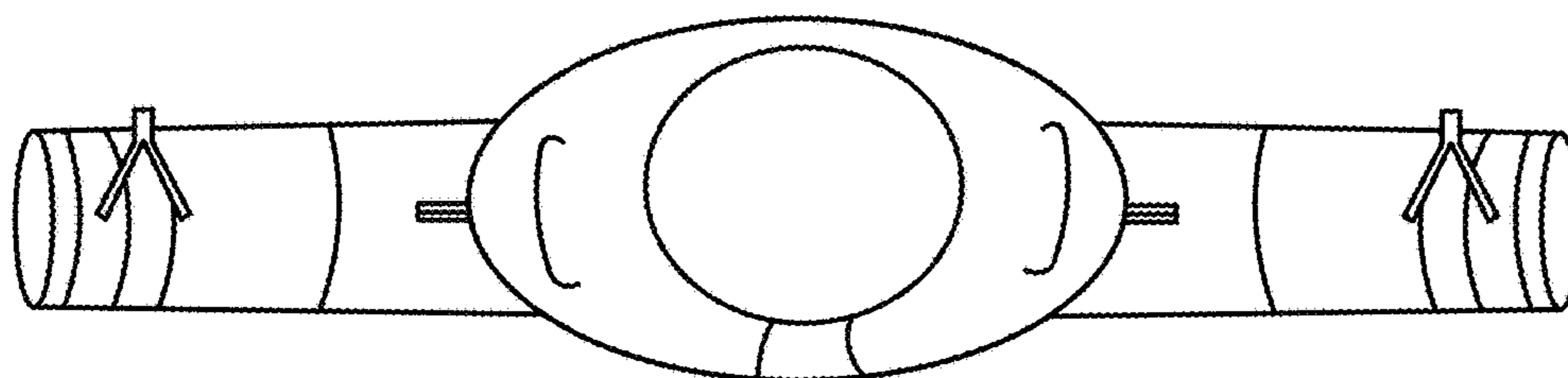

FIG. 12