



US00D781007S

(12) **United States Design Patent**
Jang et al.

(10) **Patent No.: US D781,007 S**
(45) **Date of Patent: ** Mar. 7, 2017**

(54) **WASHING MACHINE**

FOREIGN PATENT DOCUMENTS

(71) Applicant: **SAMSUNG ELECTRONICS CO., LTD.**, Suwon-si (KR)

CN	301402813	8/2010
KR	300801729	6/2015
KR	300801732	6/2015

(72) Inventors: **Hayoung Jang**, Seoul (KR); **Kangdo Kim**, Seoul (KR)

OTHER PUBLICATIONS

(73) Assignee: **SAMSUNG ELECTRONICS CO., LTD.**, Gyeonggi-Do (KR)

Modern Design Museum, p. 1 [online]. [retrieved on Feb. 23, 2016]. Retrieved from the Internet:<URL:http://www.designmuseum.or.kr/sub/sub7_1.asp?mode=view&idx=171L>.

(Continued)

(**) Term: **15 Years**

Primary Examiner — Michael A. Pratt
Assistant Examiner — Michelle E Wilson
(74) *Attorney, Agent, or Firm* — Cantor Colburn, LLP

(21) Appl. No.: **29/555,619**

(57) **CLAIM**

(22) Filed: **Feb. 23, 2016**

The ornamental design for a washing machine, as shown and described.

(30) **Foreign Application Priority Data**

DESCRIPTION

Aug. 26, 2015 (KR) 30-2015-0042957

(51) **LOC (10) Cl.** **15-05**

(52) **U.S. Cl.**
USPC **D32/6**

(58) **Field of Classification Search**
USPC D32/1, 5-6, 8, 25, 28, 29, 67
(Continued)

FIG. 1 is a perspective view of a washing machine, showing our new design;
FIG. 2 is a front view thereof;
FIG. 3 is a rear view thereof;
FIG. 4 is a side view thereof;
FIG. 5 is another side view thereof;
FIG. 6 is a top view thereof;
FIG. 7 is a bottom view thereof;
FIG. 8 is an enlarged view of the encircled portion 8 in FIG. 1, showing water supply nozzle thereof;
FIG. 9 is an enlarged view of the encircled portion 9 in FIG. 1, showing a left portion of a washboard thereof; and,
FIG. 10 is an exploded perspective view thereof.

(56) **References Cited**

U.S. PATENT DOCUMENTS

1,556,481 A *	10/1925	St Amour	D06F 3/02
				68/214
1,592,103 A *	7/1926	Gunuskey	D06F 3/00
				68/63

The broken lines in the figures illustrating portions of the washing machine form no part of the claimed design.
The dash-dot-dot broken lines encircling enlargement portions of the washing machine form no part of the claimed design.

(Continued)

1 Claim, 10 Drawing Sheets

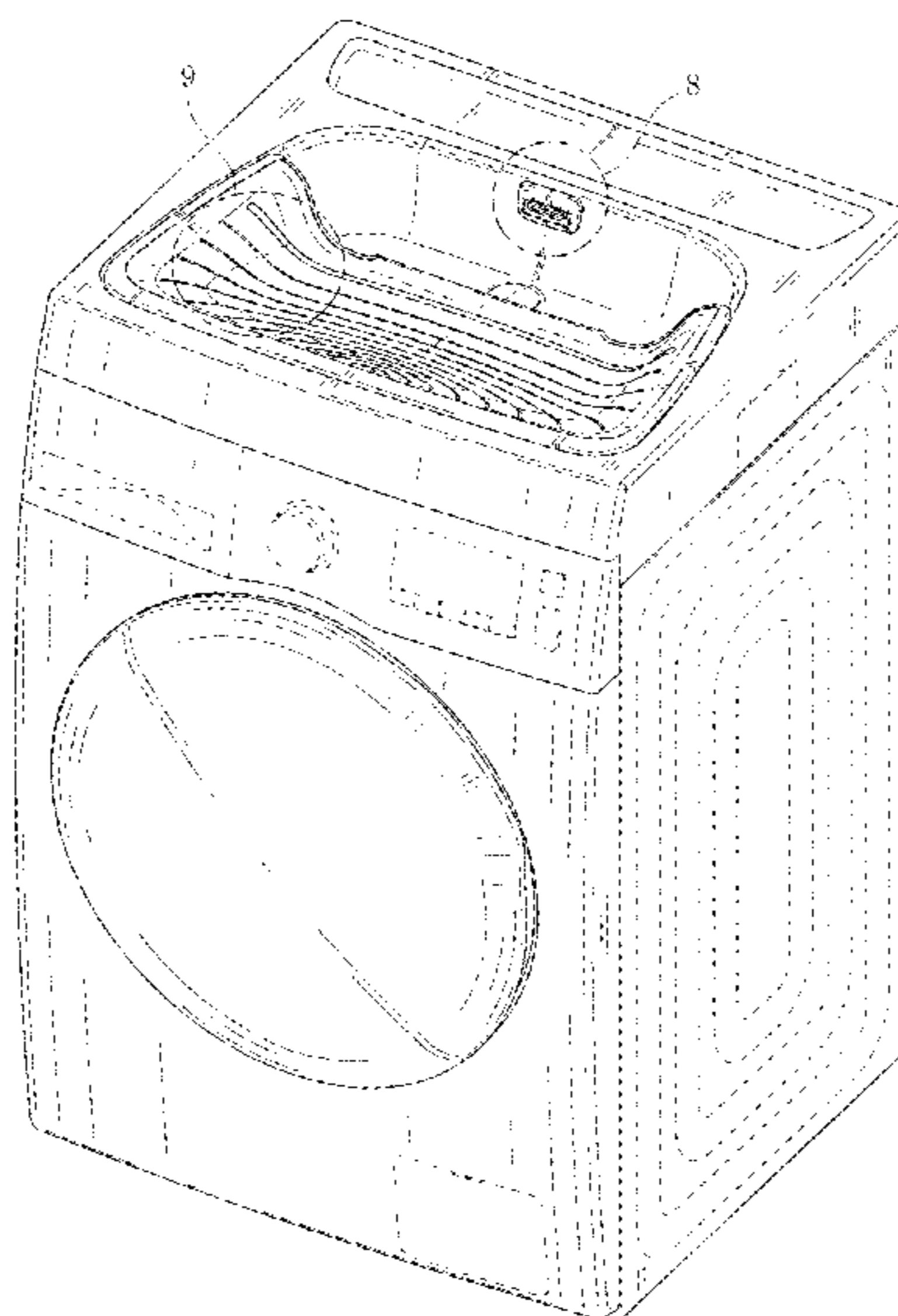

US D781,007 S

Page 2

(58) **Field of Classification Search**

CPC D06F 33/02; D06F 39/02; D06F 2204/065;
D06F 25/00; D06F 35/006

See application file for complete search history.

(56) **References Cited**

U.S. PATENT DOCUMENTS

1,814,698 A * 7/1931 Huber D06F 1/04
68/233
2,129,079 A * 9/1938 Adams D06F 3/02
68/223
2,431,539 A * 11/1947 Campanell D06F 3/02
248/27.5
D153,319 S * 4/1949 Rabinowitz D32/67
2,504,819 A * 4/1950 Flores D06F 3/02
68/224
2,704,448 A * 3/1955 Pettit D06F 3/02
68/229
D189,496 S * 12/1960 Kinyon D32/67

D193,208 S * 7/1962 Graham D32/67
3,664,160 A * 5/1972 Muniz D06F 3/00
68/224
D235,001 S * 4/1975 Sunday D32/67
D235,002 S * 4/1975 Sunday D32/67
D237,448 S * 11/1975 Sunday D32/67
D254,230 S * 2/1980 Sanger D32/67
D259,993 S * 7/1981 Kunze D32/67
4,756,439 A * 7/1988 Perock D06F 1/04
15/264
6,169,237 B1 * 1/2001 Sanders G10D 13/06
84/102
D549,915 S * 8/2007 Pastrana-Rangel D32/67

OTHER PUBLICATIONS

Samsung CE Korea. pp. 1-26 [online]. [retrieved on Feb. 23, 2016].
Retrieved from the Internet: <URL: <http://samsungcekorea.com/m/post/2607>>.

* cited by examiner

FIG. 1

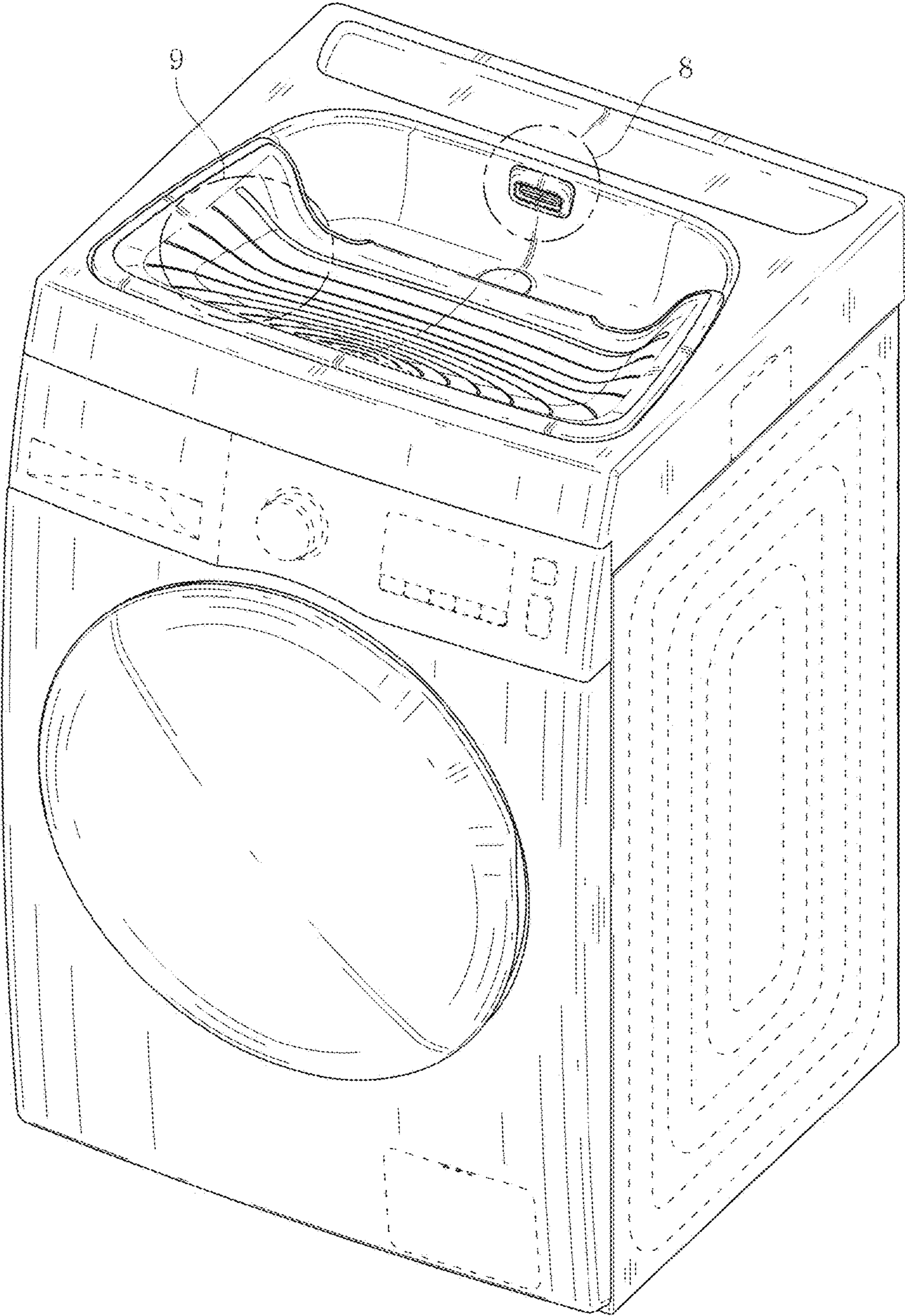

FIG. 2

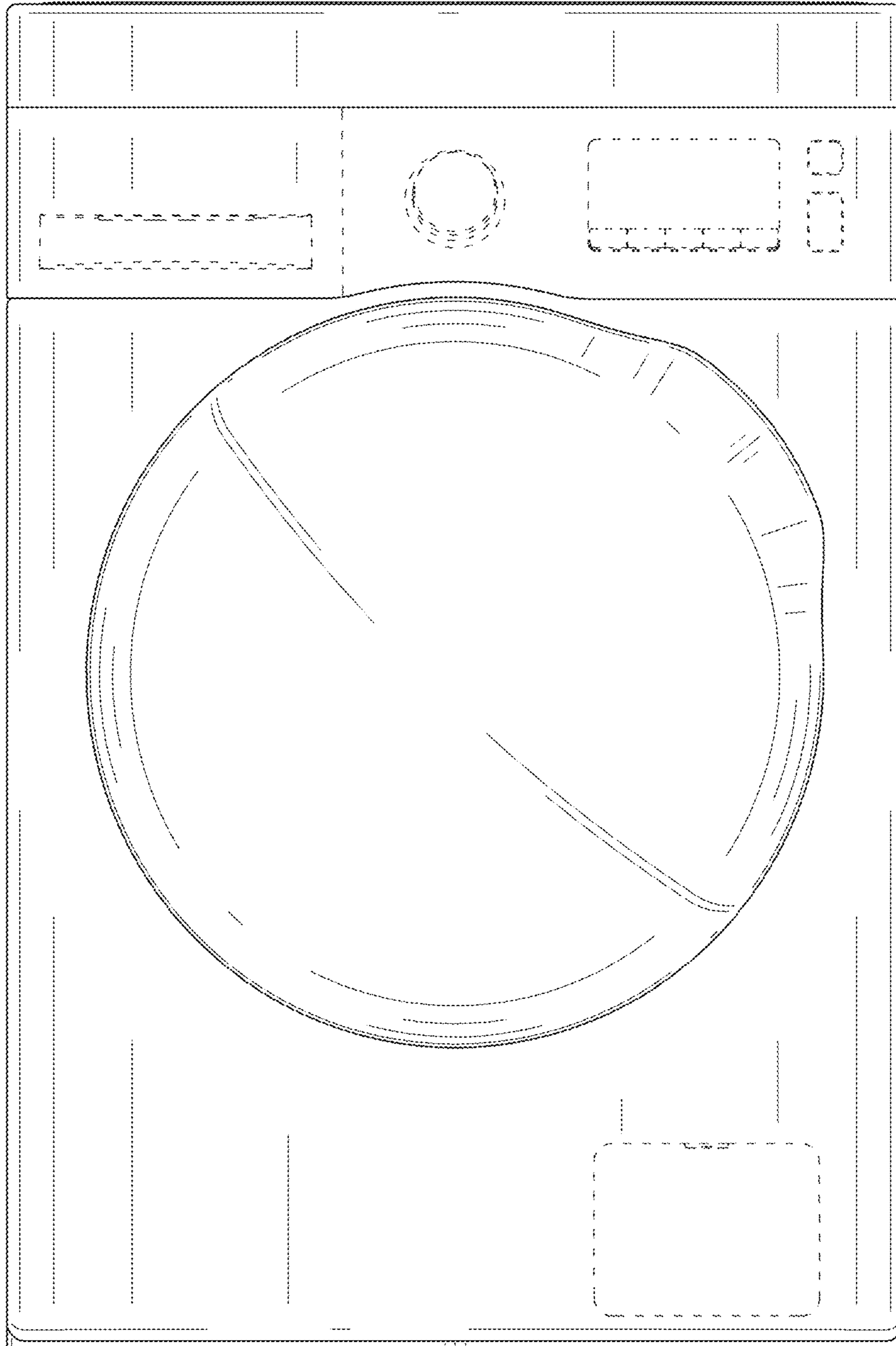

FIG. 3

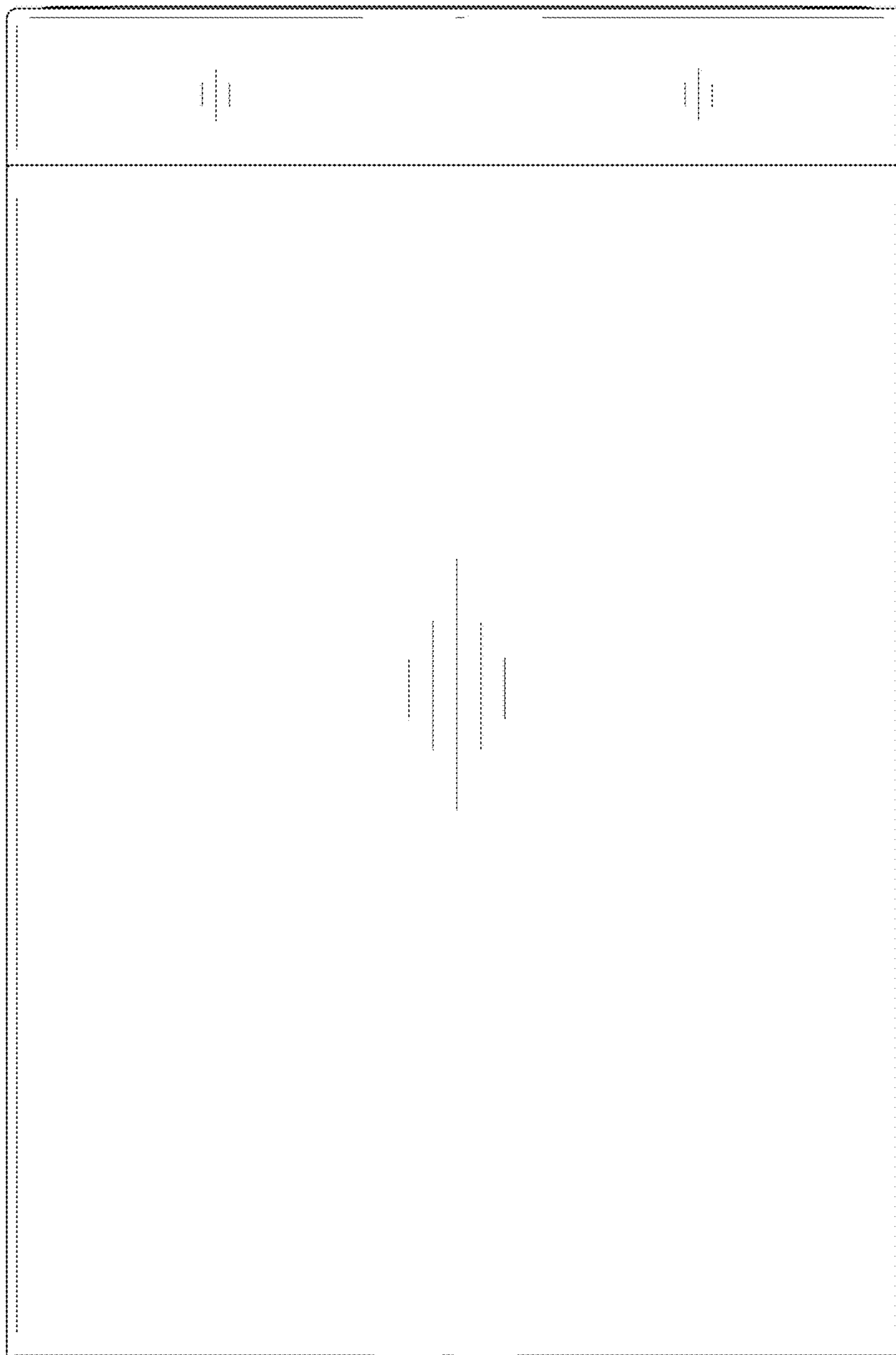

FIG. 4

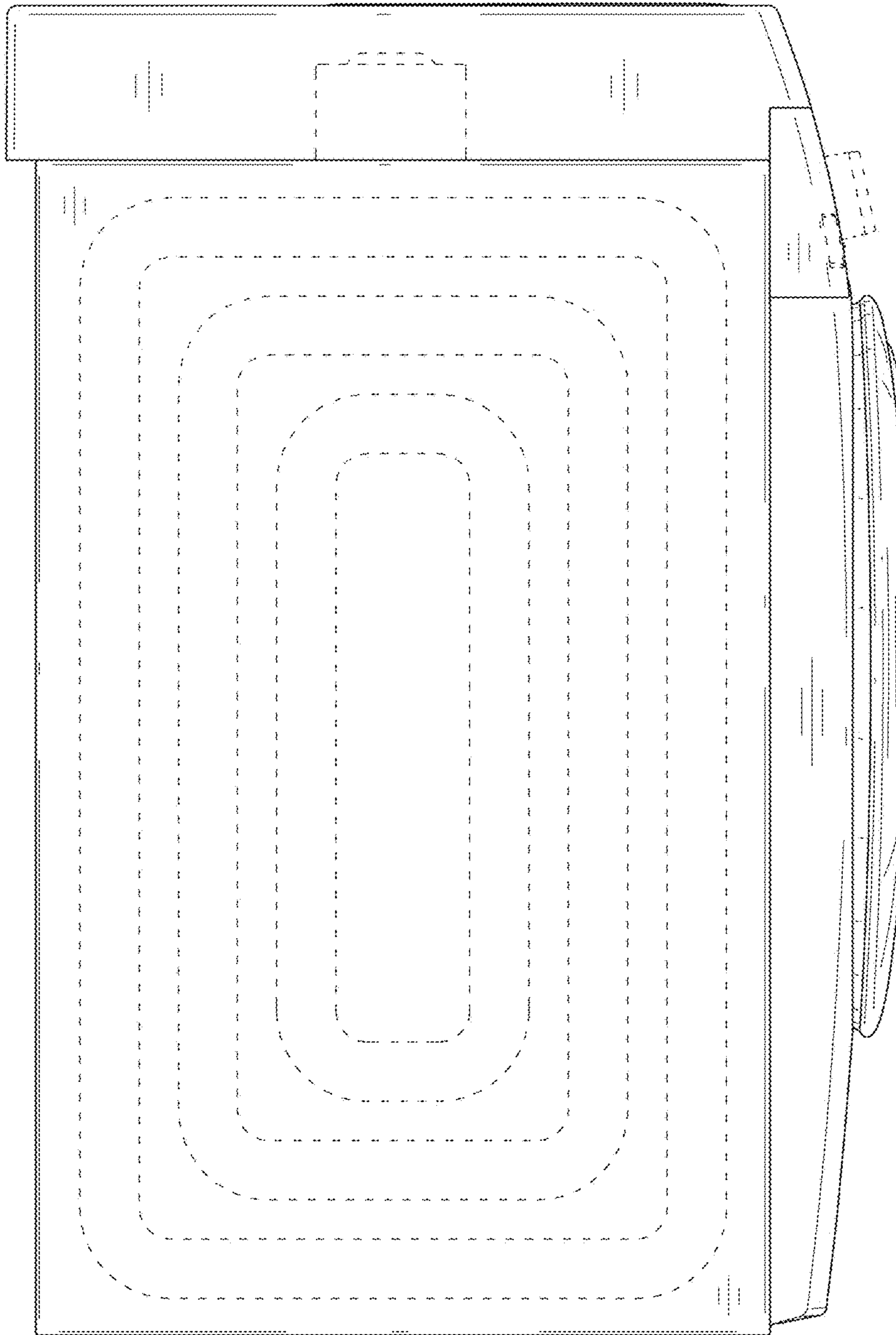

FIG. 5

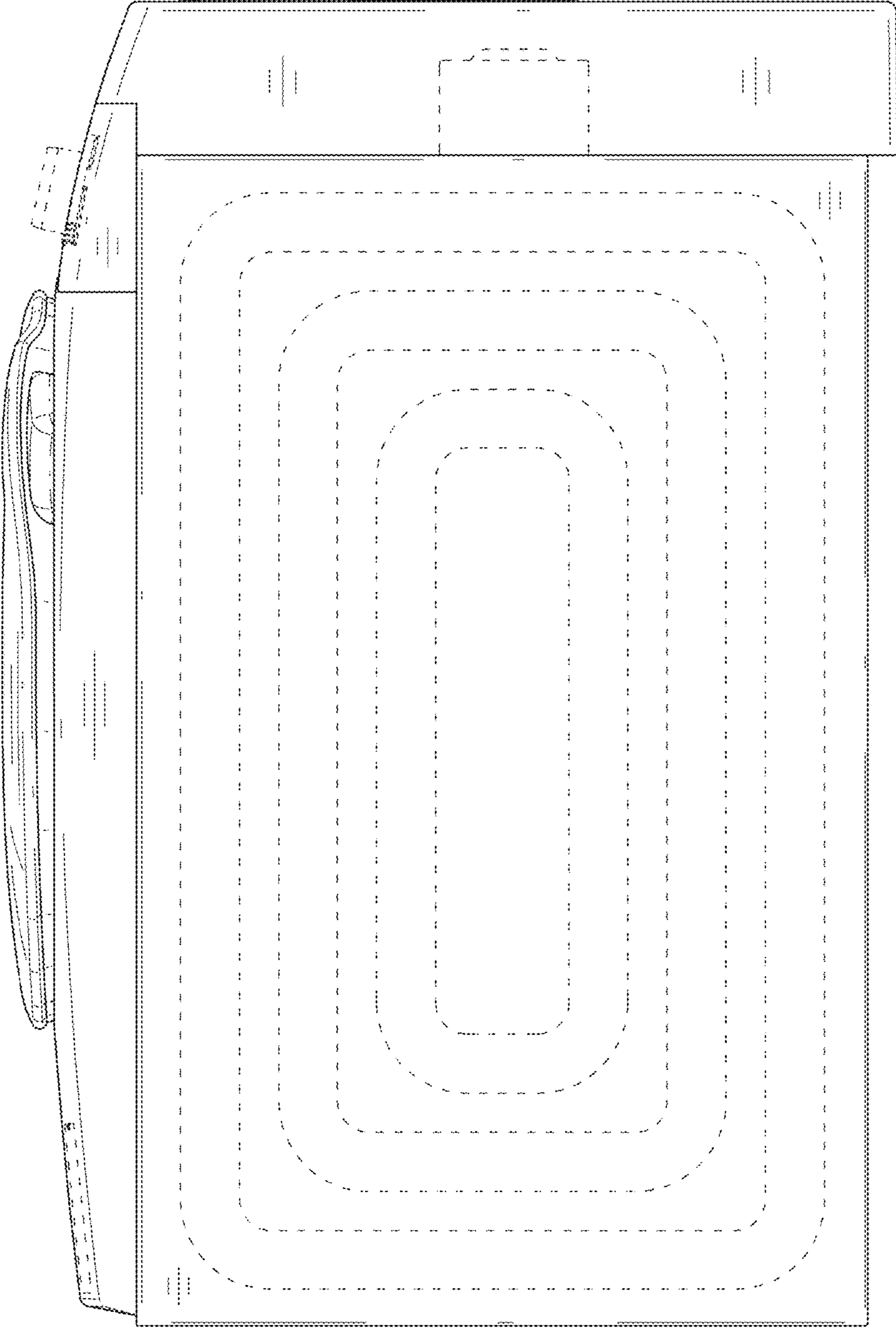

FIG. 6

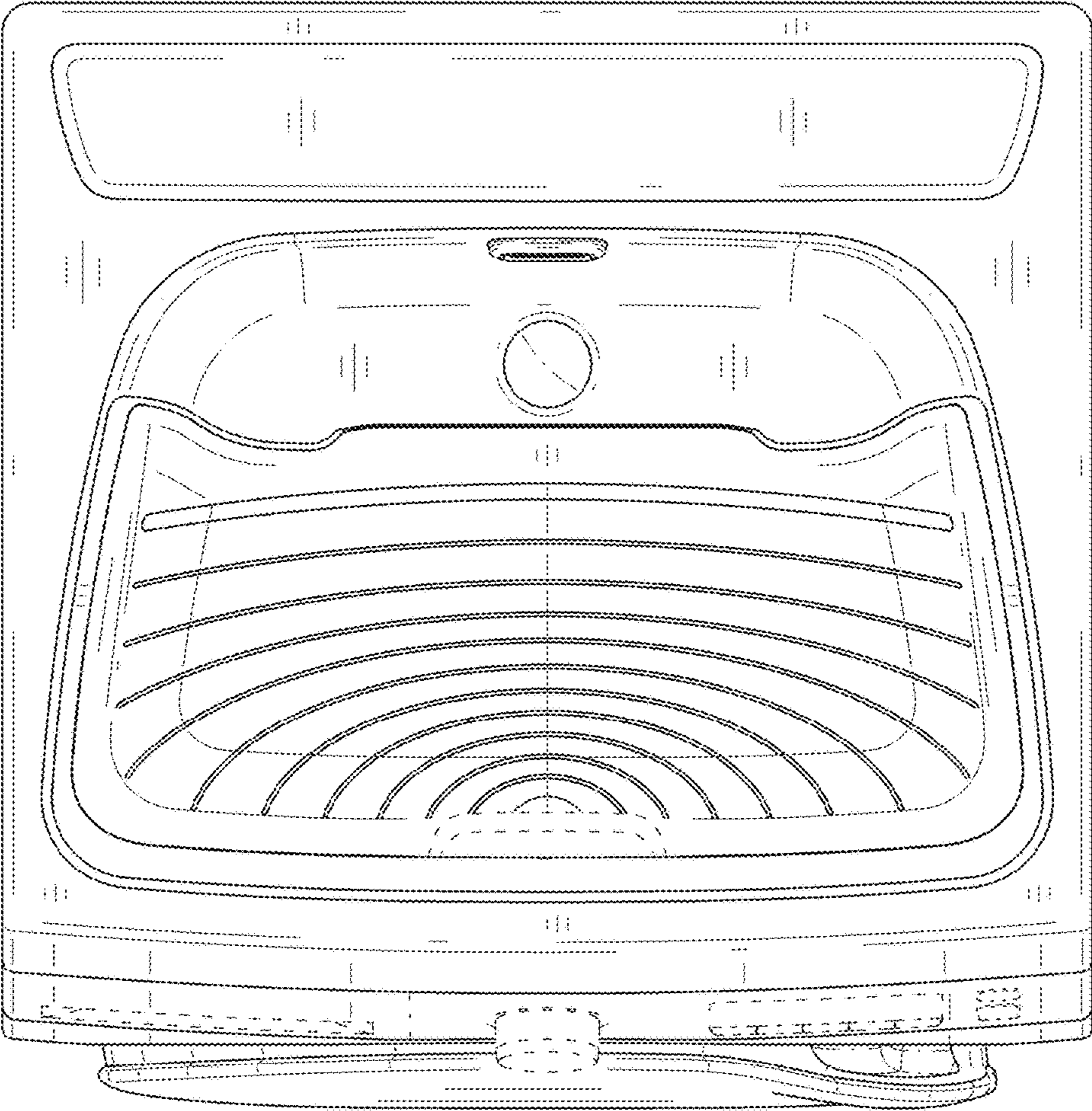

FIG. 7

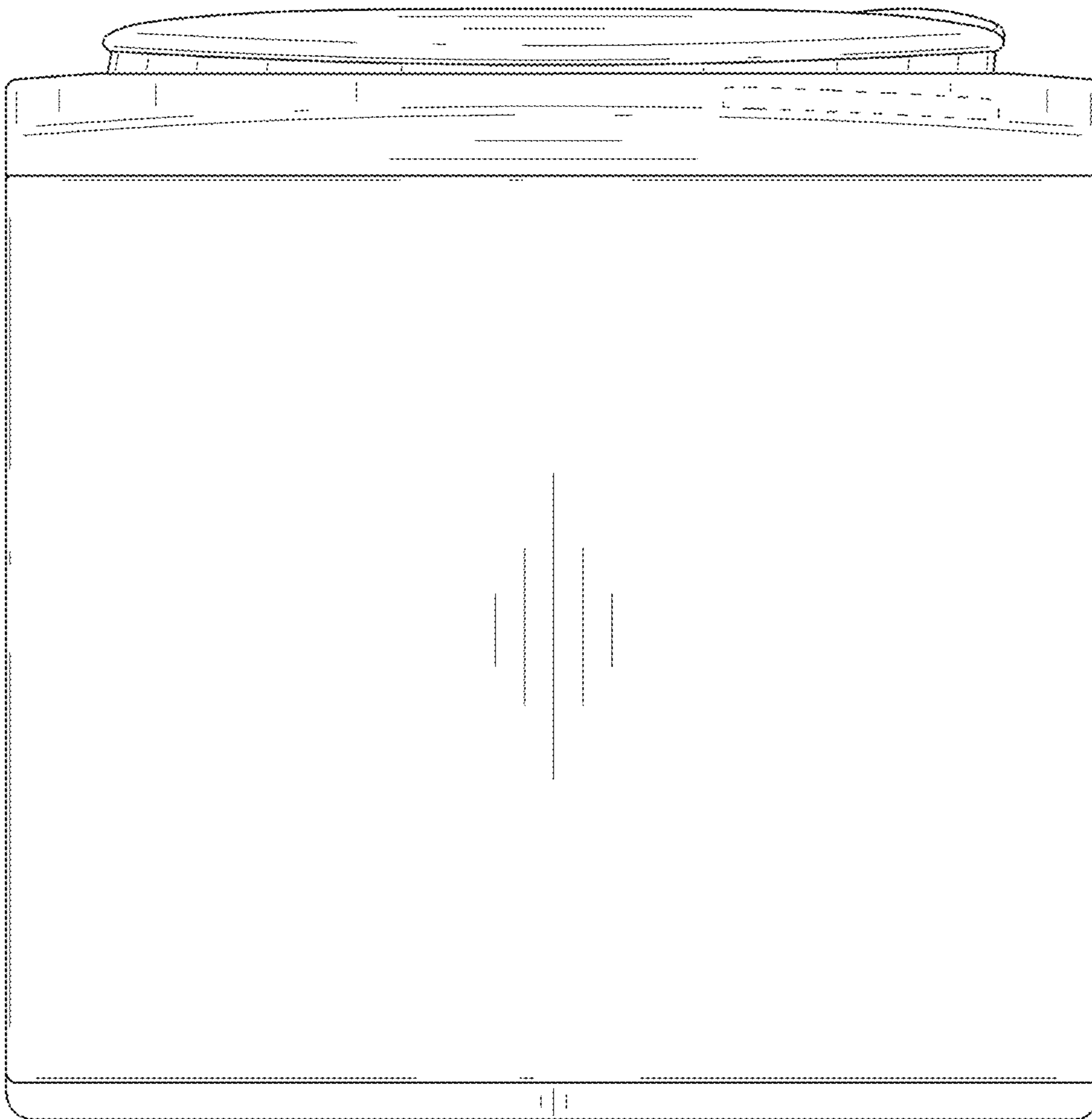

FIG. 8

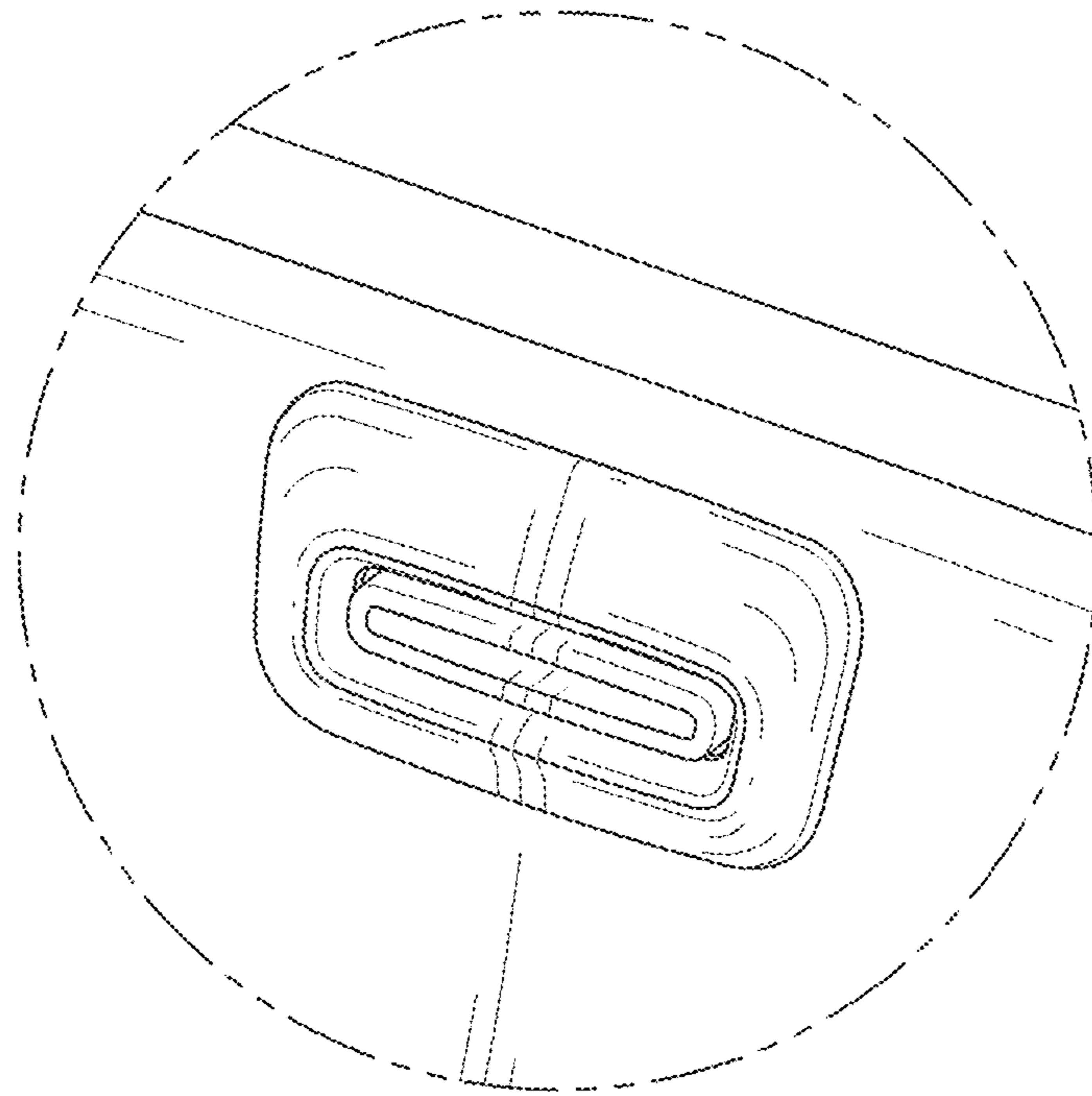

FIG. 9

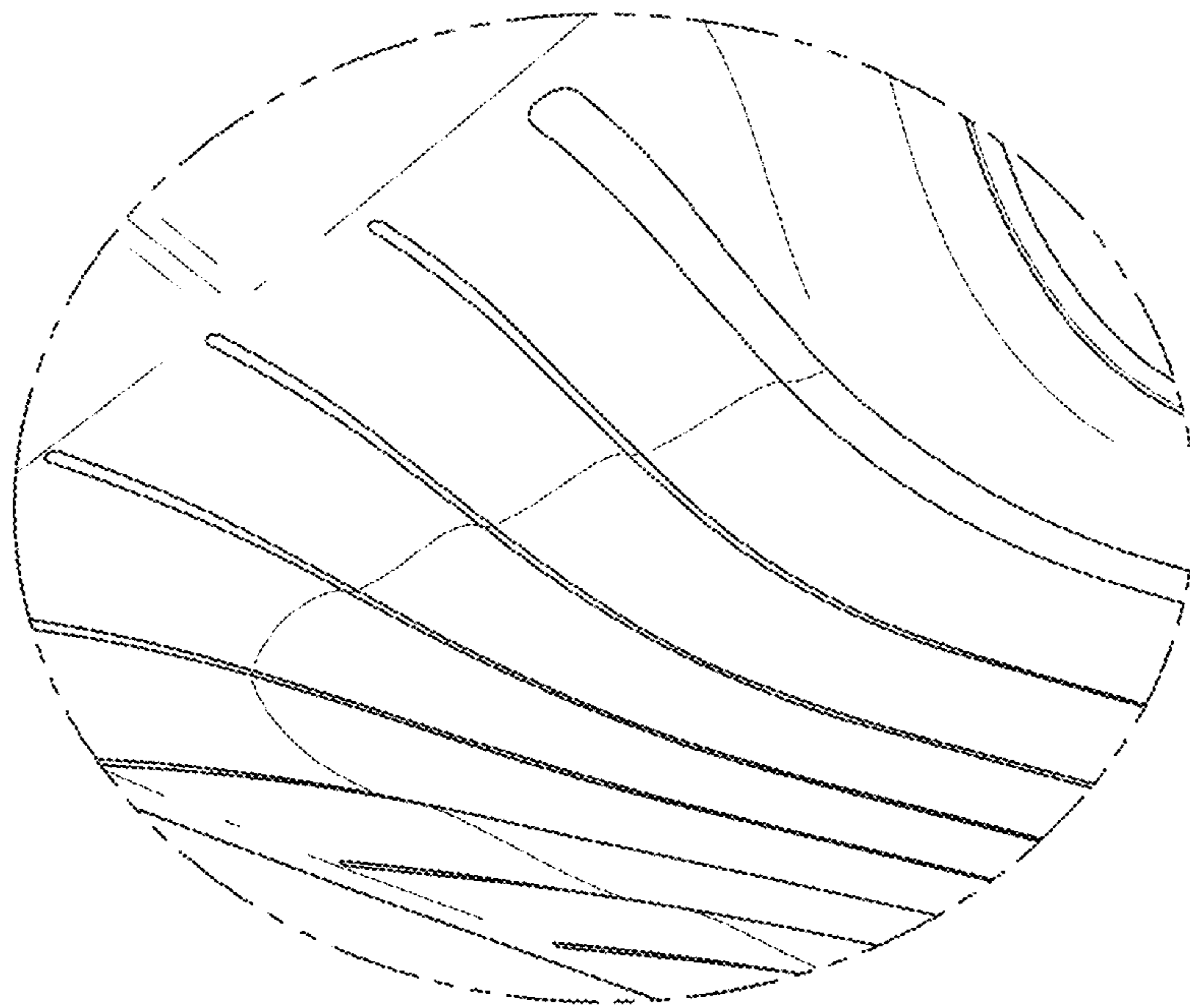

FIG. 10

