



US00D780894S

(12) **United States Design Patent**  
**French**

(10) **Patent No.:** **US D780,894 S**

(45) **Date of Patent:** **\*\* Mar. 7, 2017**

(54) **GUTTER DOWNSPOUT ACCESSORY**

(71) Applicant: **Jerry Ray French**, Seaside, OR (US)

(72) Inventor: **Jerry Ray French**, Seaside, OR (US)

(\*\*) Term: **15 Years**

(21) Appl. No.: **29/561,879**

(22) Filed: **Apr. 20, 2016**

(51) **LOC (10) Cl.** ..... **23-01**

(52) **U.S. Cl.**  
USPC ..... **D23/267**

(58) **Field of Classification Search**  
USPC ..... D23/259–262, 265–269, 393; 285/4, 64,  
285/148.24, 184, 226, 239, 404, 424, 903;  
52/16; 138/119  
CPC ..... E04D 13/09; E04D 13/064; E04D 13/076;  
E04D 13/0722; E04D 2013/0833; E04D  
2013/082; E04D 2013/0866; E04D  
2013/086; E04D 2013/0813; B01D 23/16;  
B01D 23/18; F16L 11/15; F16L 25/14;  
F16L 25/0009; F16L 25/0045; F16L  
25/0063

See application file for complete search history.

(56) **References Cited**

**U.S. PATENT DOCUMENTS**

1,076,075	A	*	10/1913	Steele	.....	B01D 35/02 210/447
D260,422	S	*	8/1981	Husted	.....	D23/209
D288,230	S	*	2/1987	Thatcher	.....	D23/263
D288,840	S	*	3/1987	Williams	.....	D23/261
D354,552	S	*	1/1995	Weber	.....	D23/261
D380,253	S	*	6/1997	Moya	.....	D23/267
D421,101	S	*	2/2000	Barnett	.....	D23/261

D482,433	S	*	11/2003	Sawyer	.....	D23/267
D575,853	S	*	8/2008	Adamson	.....	D23/267
D732,147	S	*	6/2015	French	.....	D23/267
9,080,328	B1	*	7/2015	Smith	.....	E04D 13/0767
D752,190	S	*	3/2016	DeNooy	.....	D23/267
2011/0203191	A1	*	8/2011	Argentina	.....	E04D 13/0645 52/12

\* cited by examiner

*Primary Examiner* — Eric Goodman

*Assistant Examiner* — Amy Wierenga

(74) *Attorney, Agent, or Firm* — Chernoff, Vilhuaer,  
McClung & Stenzel, LLP

(57) **CLAIM**

The ornamental design for a gutter downspout accessory, as shown and described.

**DESCRIPTION**

FIG. 1 is an isometric view from the upper right front of a gutter downspout accessory embodying my new design; FIG. 2 is a side view of the gutter downspout accessory shown in FIG. 1.

FIG. 3 is a front view of the gutter downspout accessory shown in FIG. 1.

FIG. 4 is a rear view of the gutter downspout accessory shown in FIG. 1.

FIG. 5 is a top view of the gutter downspout accessory shown in FIG. 1 with the gutter broken so as to view the mesh inside the gutter; and,

FIG. 6 is a bottom view of the gutter downspout accessory shown in FIG. 1 with the gutter broken so as to view the mesh inside the gutter.

The broken lines shown in FIGS. 1-6 are for the purpose of illustrating environment and form no part of the claimed design.

**1 Claim, 4 Drawing Sheets**

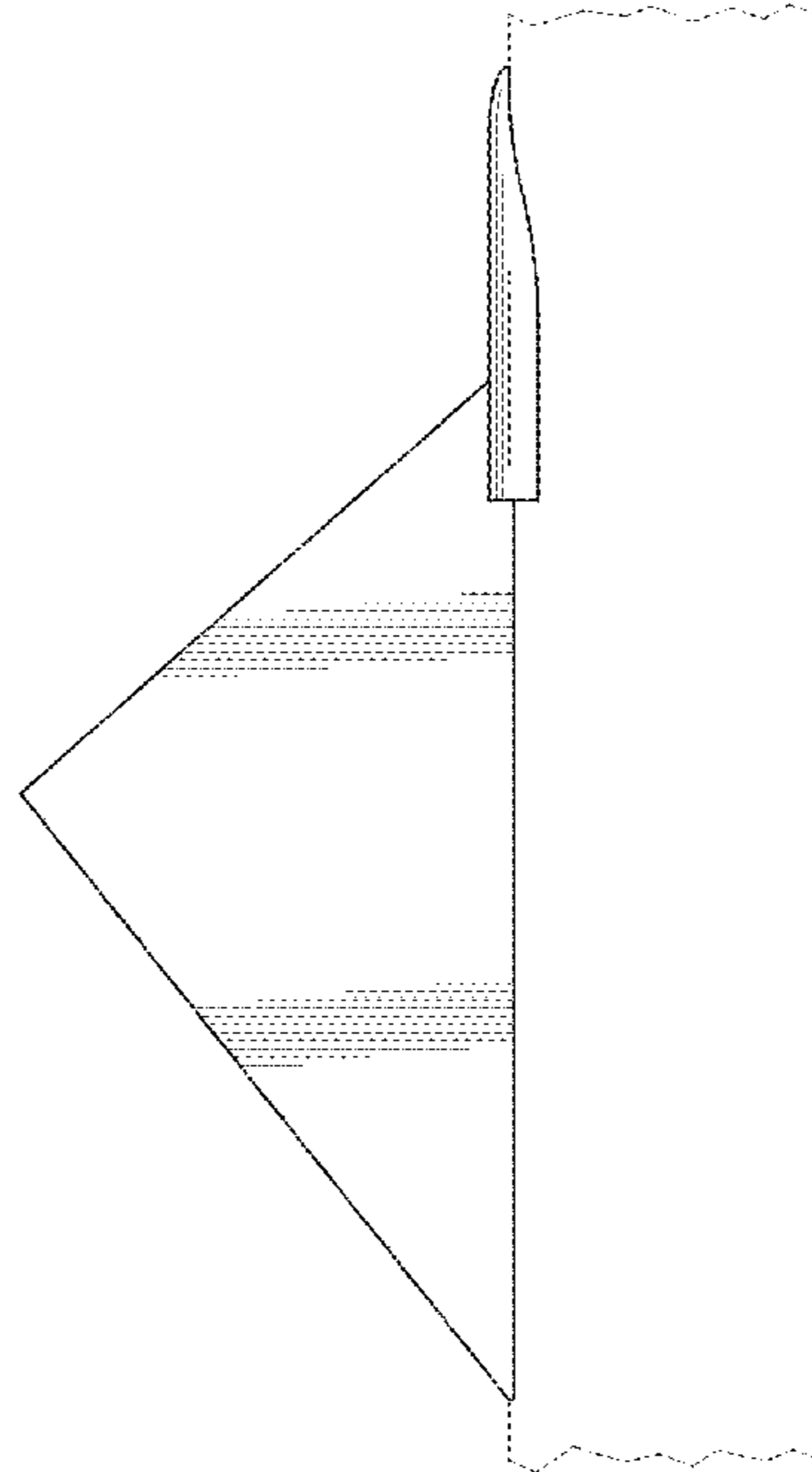
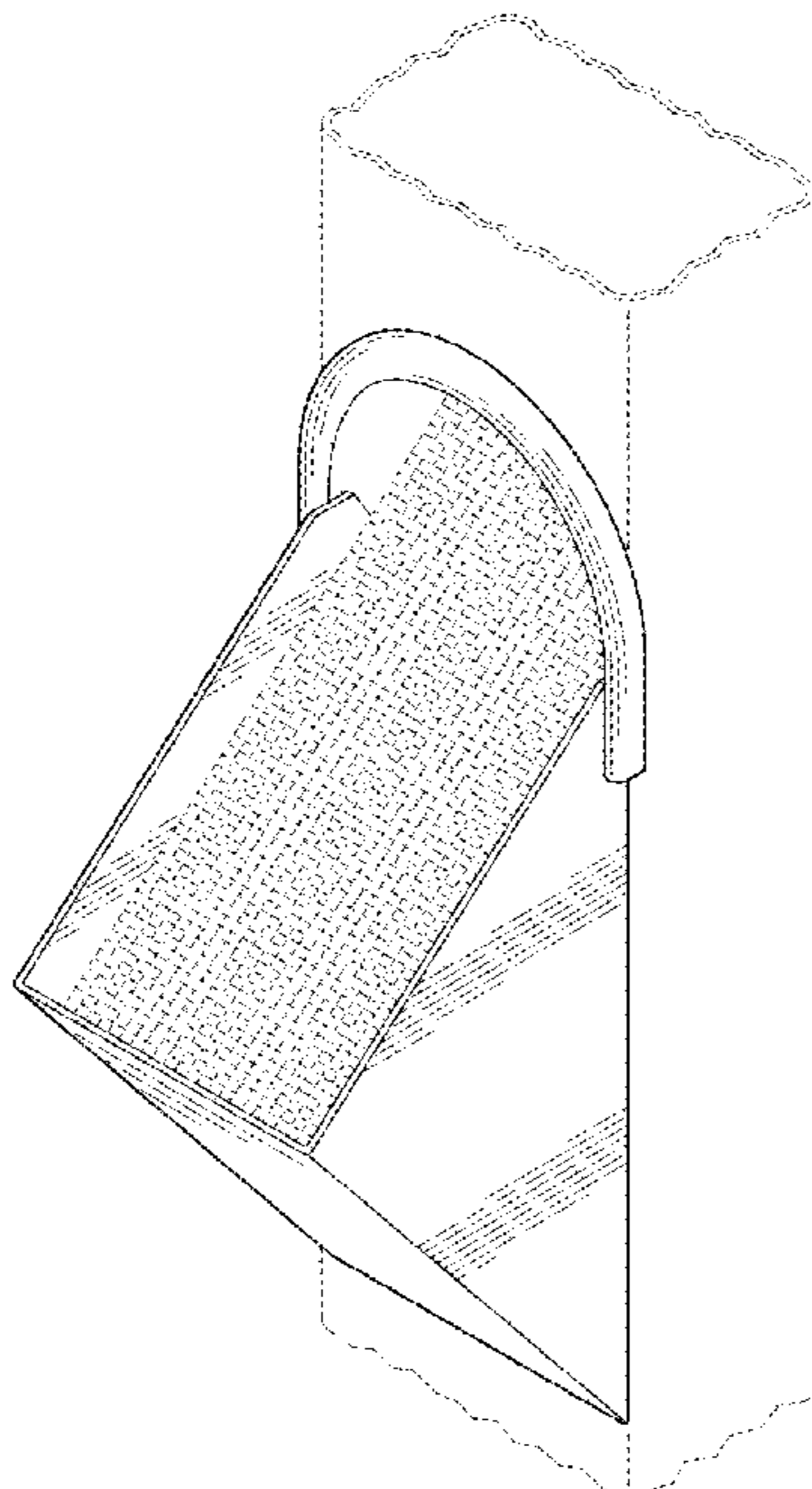

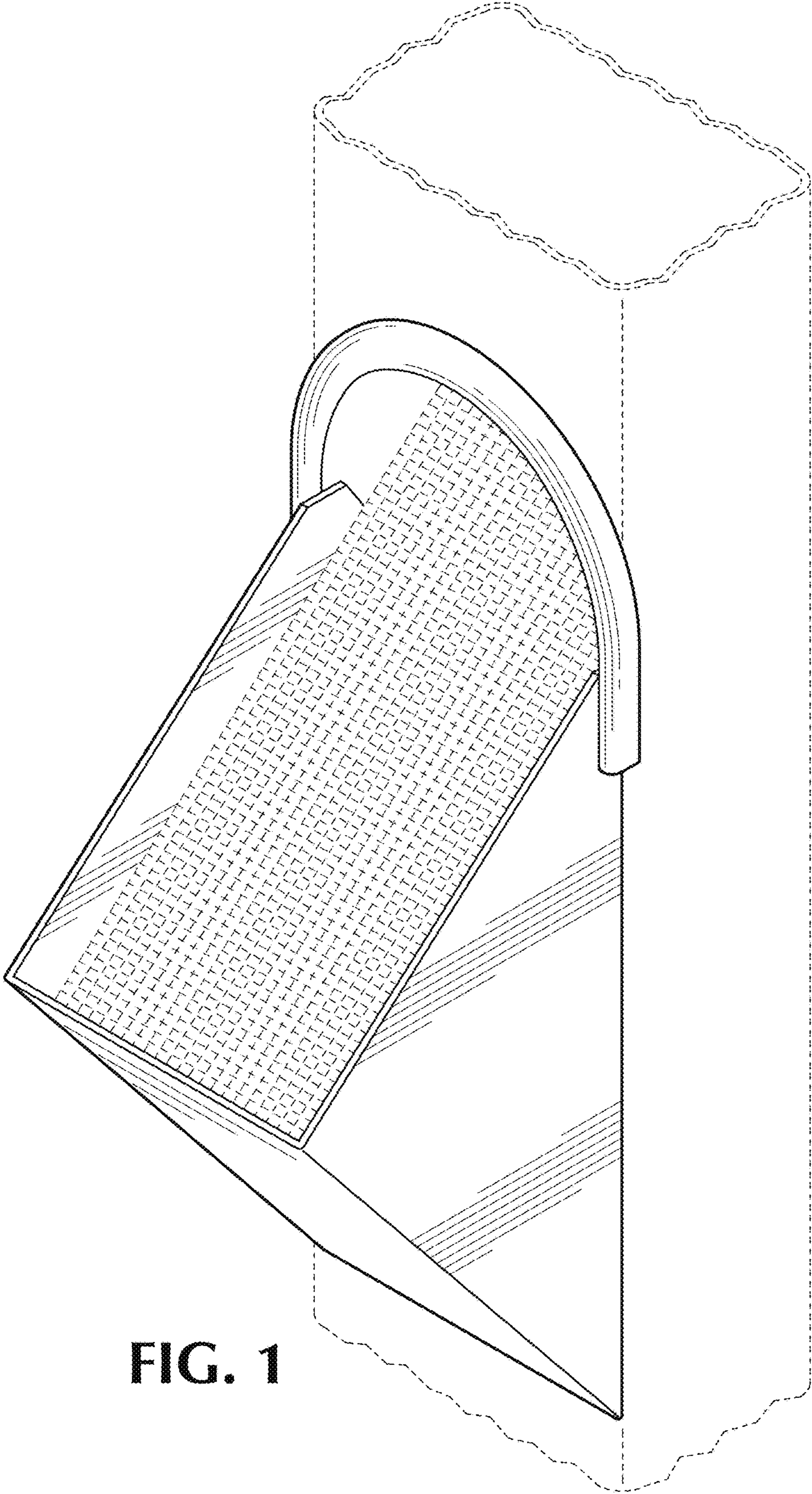

**FIG. 1**

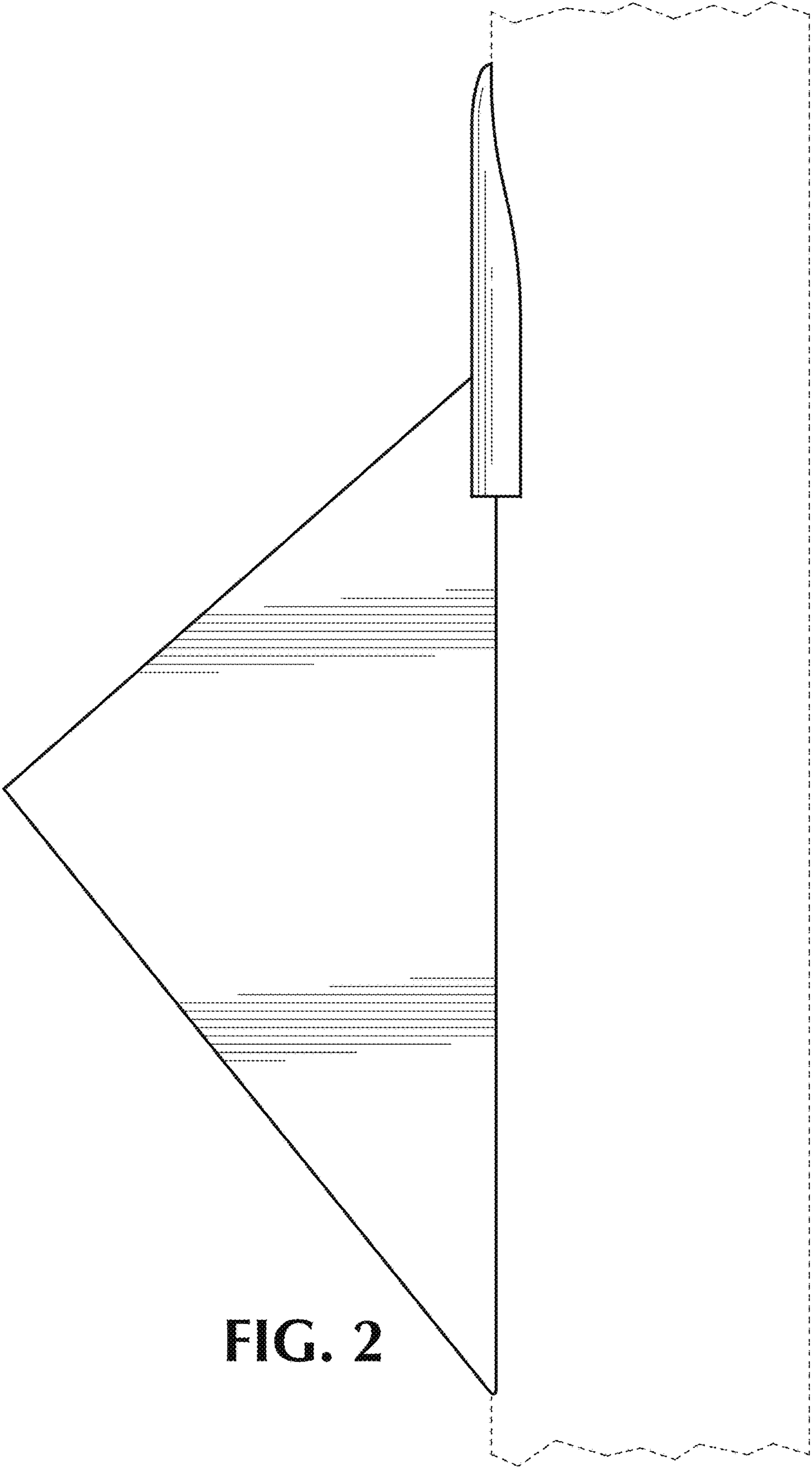

**FIG. 2**

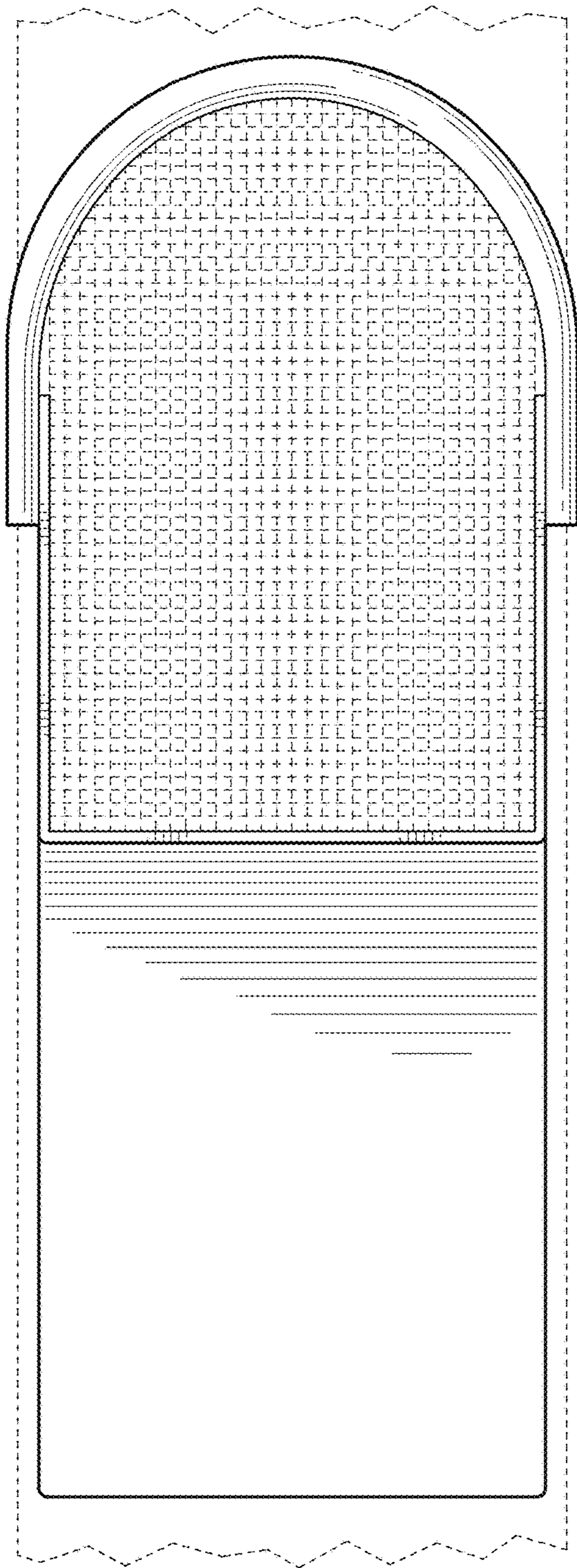

FIG. 3

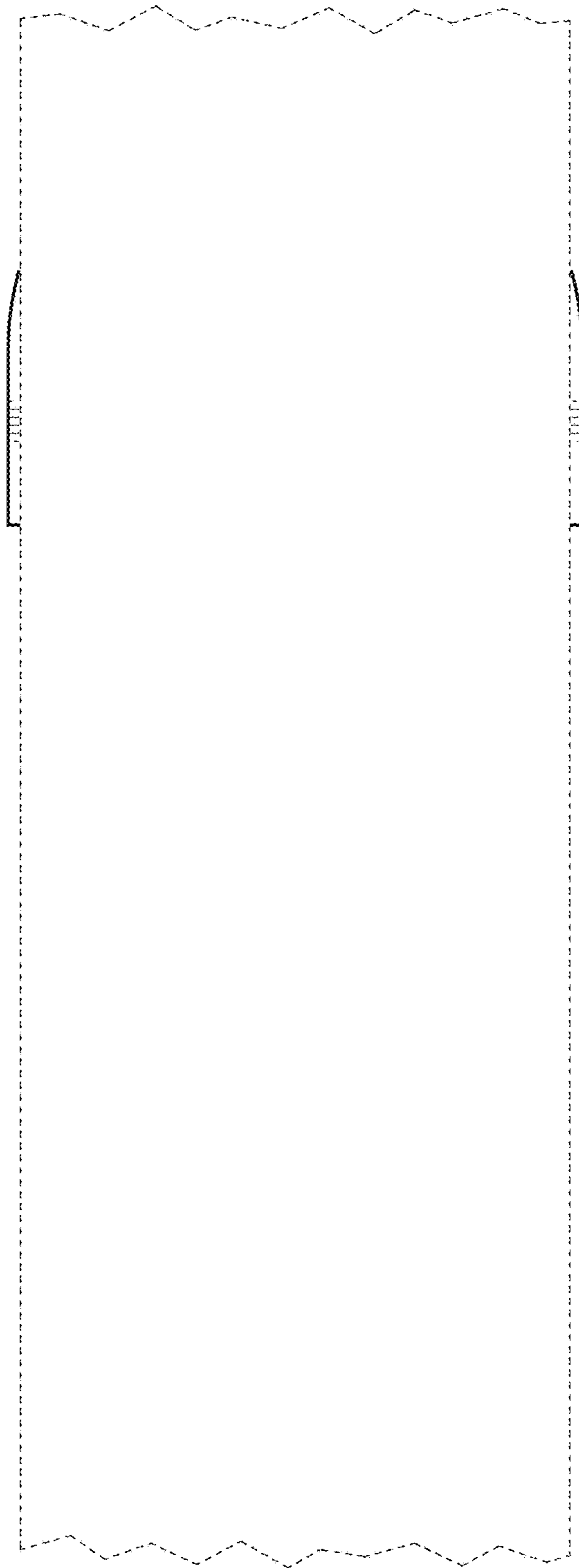

FIG. 4

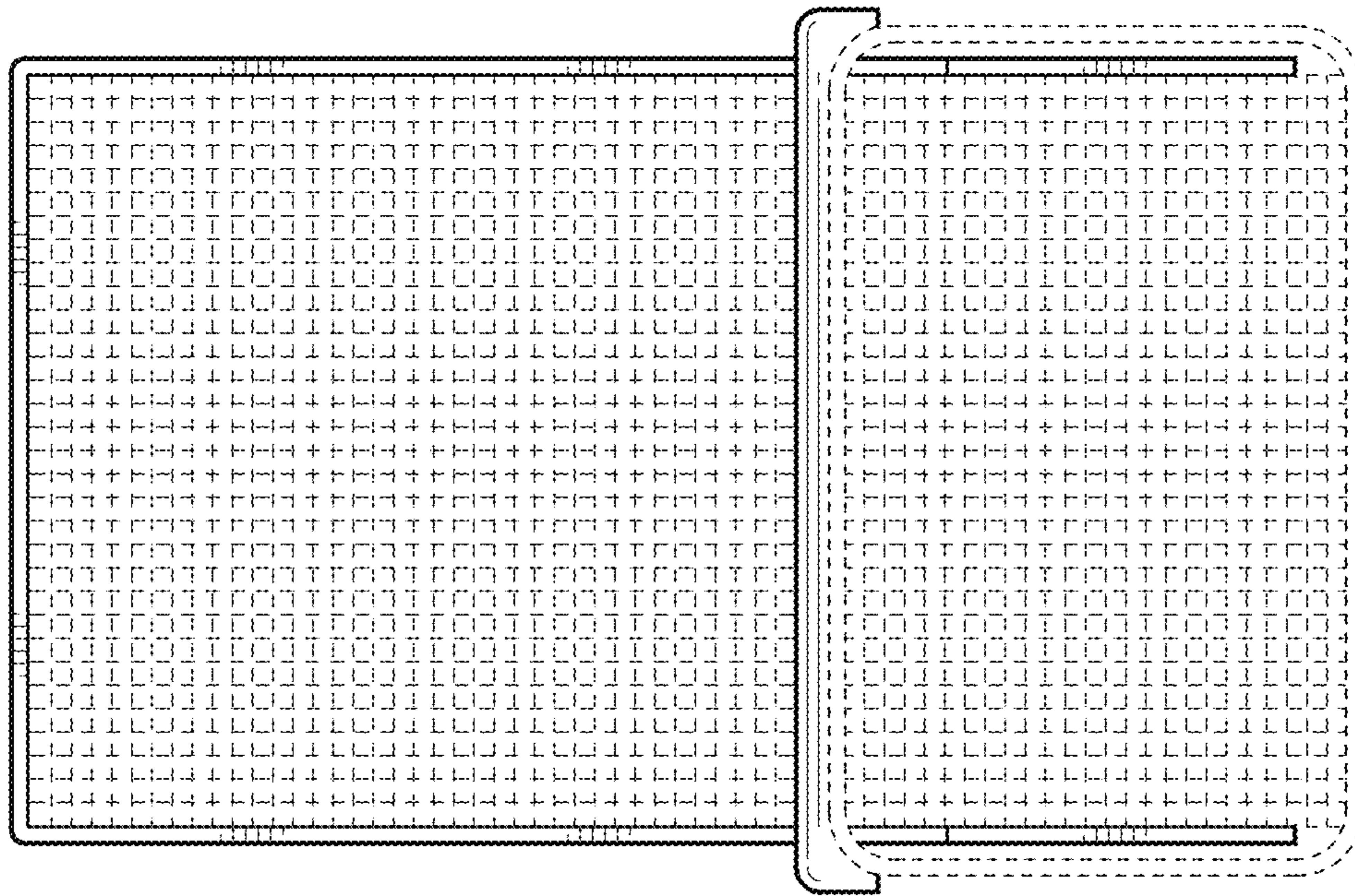

FIG. 5

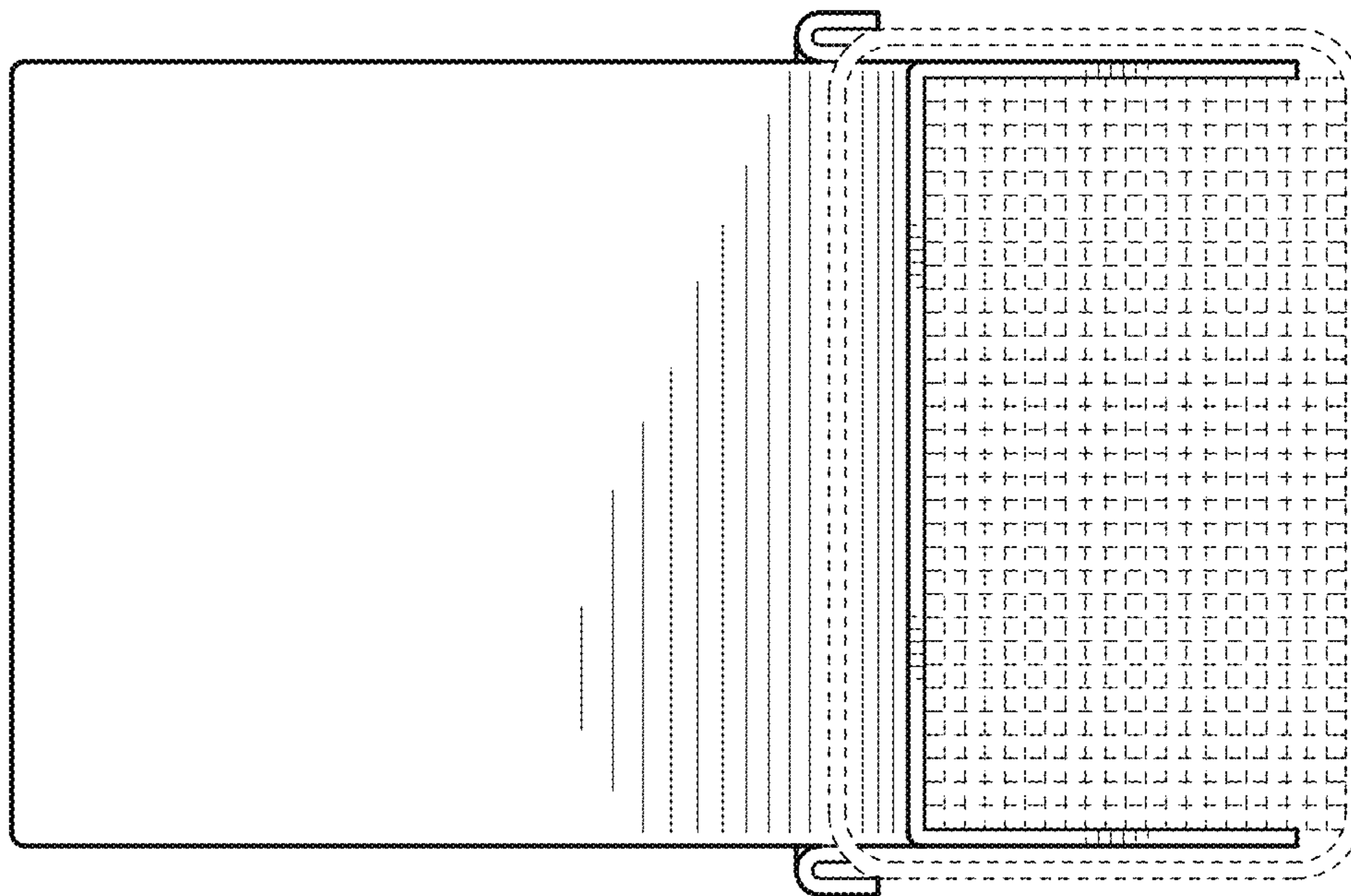

FIG. 6