



US00D780760S

(12) **United States Design Patent**
Ironmonger et al.

(10) **Patent No.:** **US D780,760 S**
(45) **Date of Patent:** **** Mar. 7, 2017**

(54) **GAMES CONTROLLER**
(71) Applicant: **Ironburg Inventions Ltd.**, Wincanton,
Somerset (GB)
(72) Inventors: **Duncan Ironmonger**, Brookhaven, GA
(US); **Carl S. Jeffrey**, Cheltenham
(GB)
(73) Assignee: **Ironburg Inventions Ltd.**, Wincanton
(GB)

6,342,009 B1 * 1/2002 Soma A63F 13/24
273/148 B
7,314,413 B2 * 1/2008 Ogata A63F 13/06
273/148 B
D572,254 S * 7/2008 Goto D14/401
7,510,477 B2 3/2009 Argentar
D608,784 S * 1/2010 Biheller D14/401
7,854,655 B2 * 12/2010 Mao G06F 3/017
273/148 B
7,859,514 B1 12/2010 Park
D712,408 S * 9/2014 Sumii D14/401
(Continued)

(**) Term: **15 Years**

FOREIGN PATENT DOCUMENTS

(21) Appl. No.: **29/556,673**

EP 2 479 636 7/2012
EP 2 698 185 2/2015

(22) Filed: **Mar. 2, 2016**

(Continued)

(51) **LOC (10) Cl.** **14-03**

OTHER PUBLICATIONS

(52) **U.S. Cl.**
USPC **D14/401**

Burns, "Review: Scut Xbox 360 Controller," Xboxer360.com
(2010).

(58) **Field of Classification Search**
USPC D14/496, 401, 435, 474, 483, 217, 137,
D14/138, 160, 168, 356, 203.1-203.8,
D14/507; 345/156, 169, 173-179, 905;
715/727-729, 864, 700, 706, 719; 710/1,
710/5, 8; 713/1, 600; 455/1.1, 1.7, 73,
455/344-347, 93, 95, 3.01-3.06, 550.1,
455/573.1; 370/342-344; 369/1, 2, 6-12;
463/51-57, 40-47, 1, 29-35; D21/324,
D21/328, 333; 273/148 B
CPC A63F 13/00; A63F 13/02; A63F 9/00;
G06F 17/00; G06F 19/00
See application file for complete search history.

(Continued)

Primary Examiner — Prabhakar Deshmukh
(74) *Attorney, Agent, or Firm* — Walters & Wasylyna
LLC

(57) **CLAIM**

The ornamental design for a games controller, as shown and
described.

DESCRIPTION

FIG. 1 is a perspective view of a games controller in
accordance with the present design;
FIG. 2 is a front view of the games controller of FIG. 1;
FIG. 3 is a rear view of the games controller of FIG. 1;
FIG. 4 is a bottom view of the games controller of FIG. 1;
FIG. 5 is a top view of the games controller of FIG. 1;
FIG. 6 is a left side view of the games controller of FIG. 1;
and,
FIG. 7 is a right side view of the games controller of FIG.
1.

(56) **References Cited**

U.S. PATENT DOCUMENTS

D424,047 S * 5/2000 Chan D14/401
6,171,191 B1 * 1/2001 Ogata A63F 13/06
273/148 B
6,231,444 B1 * 5/2001 Goto G05G 9/047
273/148 B
D443,617 S * 6/2001 Goto D14/413
6,251,015 B1 6/2001 Caprai

1 Claim, 7 Drawing Sheets

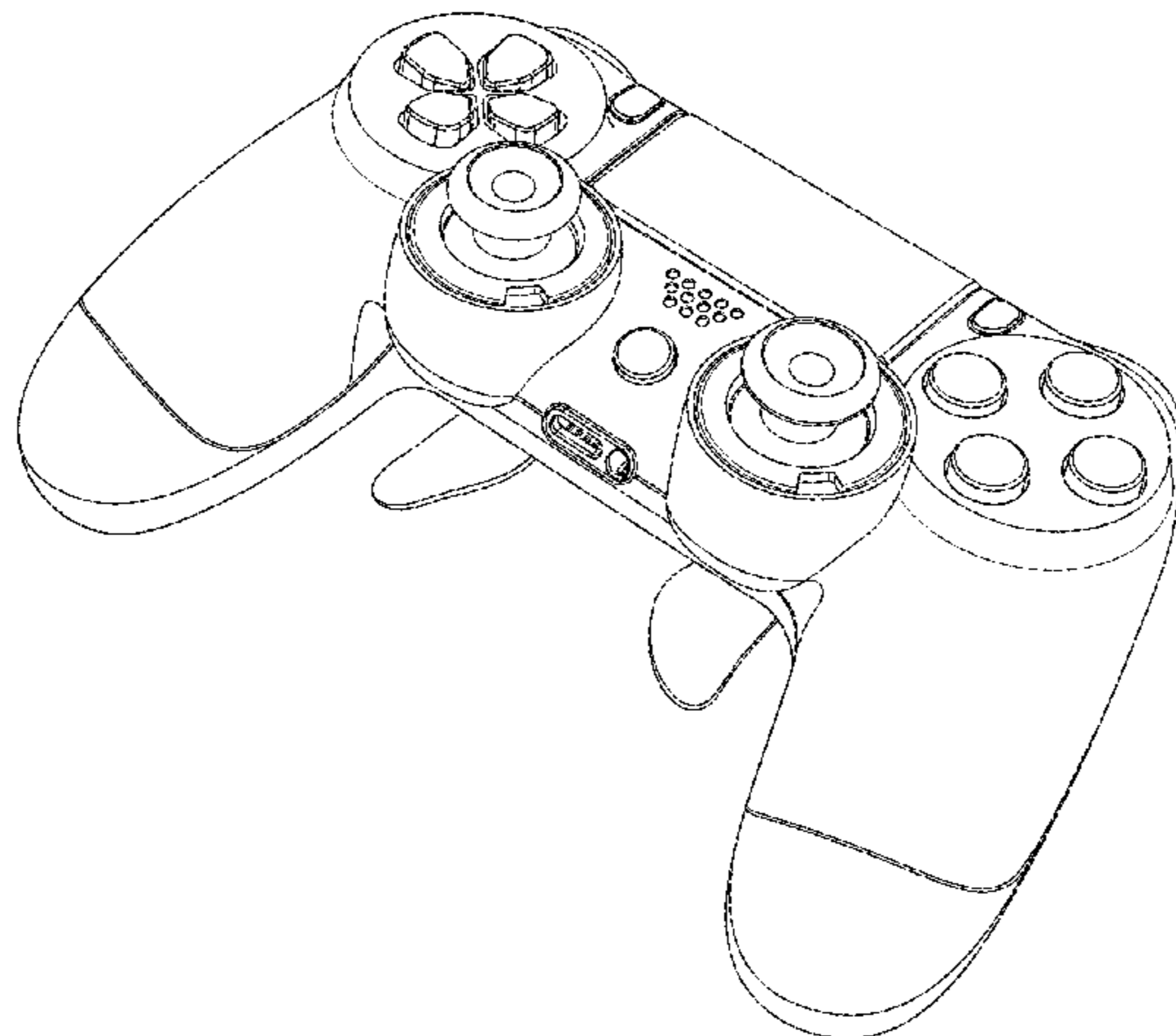

(56)

References Cited

U.S. PATENT DOCUMENTS

D715,296 S * 10/2014 Huang D14/401
D733,802 S * 7/2015 Burgess D14/401
D766,375 S * 9/2016 Kujawski D14/401
2001/0003713 A1 6/2001 Willner et al.
2002/0052237 A1 5/2002 Magill
2002/0128064 A1 9/2002 Sobota
2003/0067111 A1 4/2003 Swan
2004/0259059 A1 12/2004 Aoki
2005/0083297 A1 4/2005 Duncan
2005/0255918 A1 11/2005 Riggs et al.
2009/0088250 A1 4/2009 Carlson
2009/0258705 A1 10/2009 Guinchard
2010/0304865 A1 12/2010 Picunko
2011/0256930 A1 10/2011 Jaouen
2011/0281649 A1 11/2011 Jaouen
2012/0322553 A1 12/2012 Burgess et al.
2014/0274397 A1 9/2014 Sebastian
2015/0238855 A1 8/2015 Uy et al.

FOREIGN PATENT DOCUMENTS

GB 2 244 546 12/1991
GB 2 481 633 1/2012
WO WO 2008/131249 10/2008

OTHER PUBLICATIONS

“Rapid Fire Mod for Wireless Xbox 360 Controller,” forum on xbox-scene.com, (2008).
“Thrustmaster USB game controller roundup,” dansdata.com/tmsticks.htm (2002).
Coles, Olin, “Thrustmaster Run-N-Drive PC/PS3 Wireless Gamepad” BenchmarkReviews.com (2009).

* cited by examiner



FIG. 1

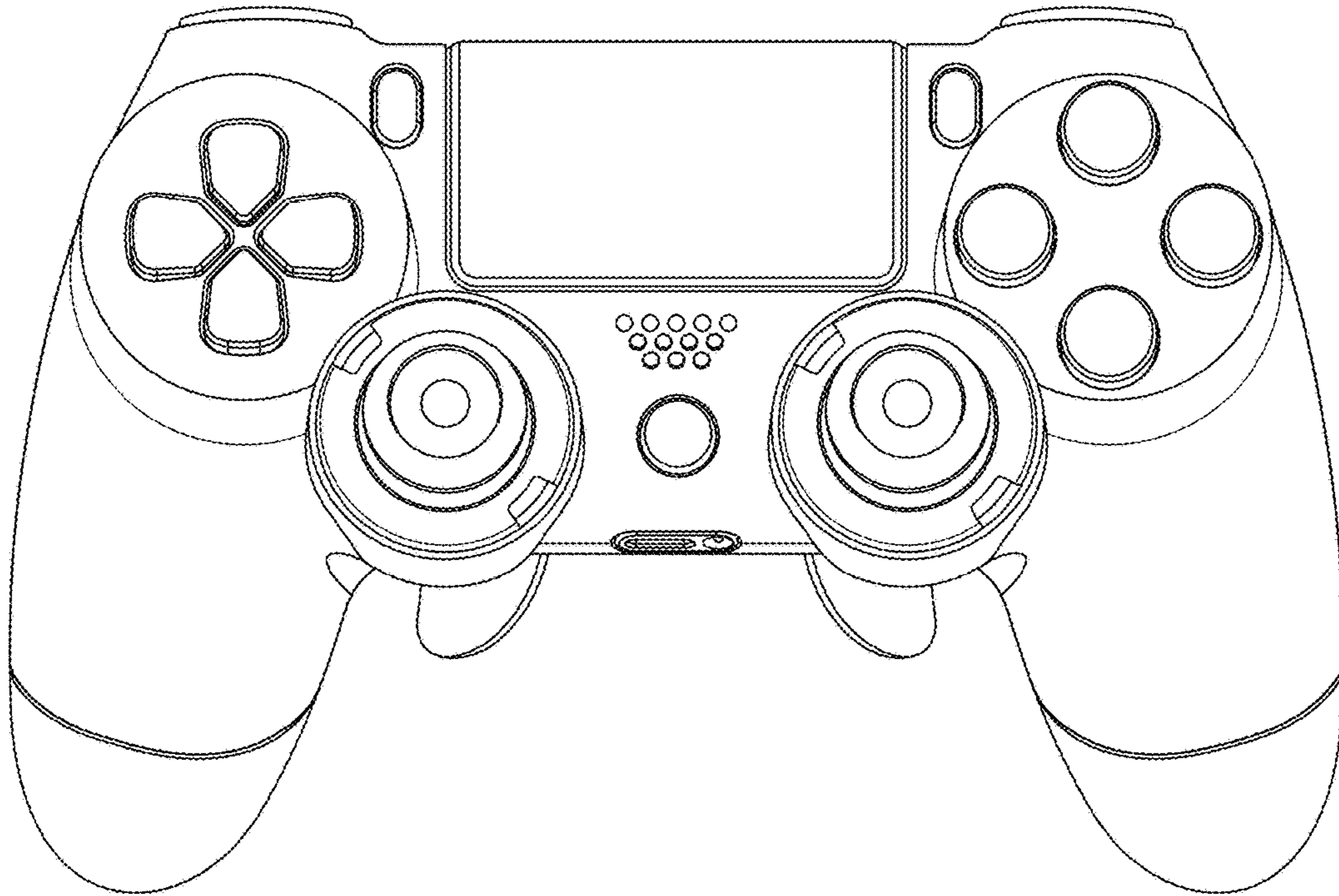

FIG. 2

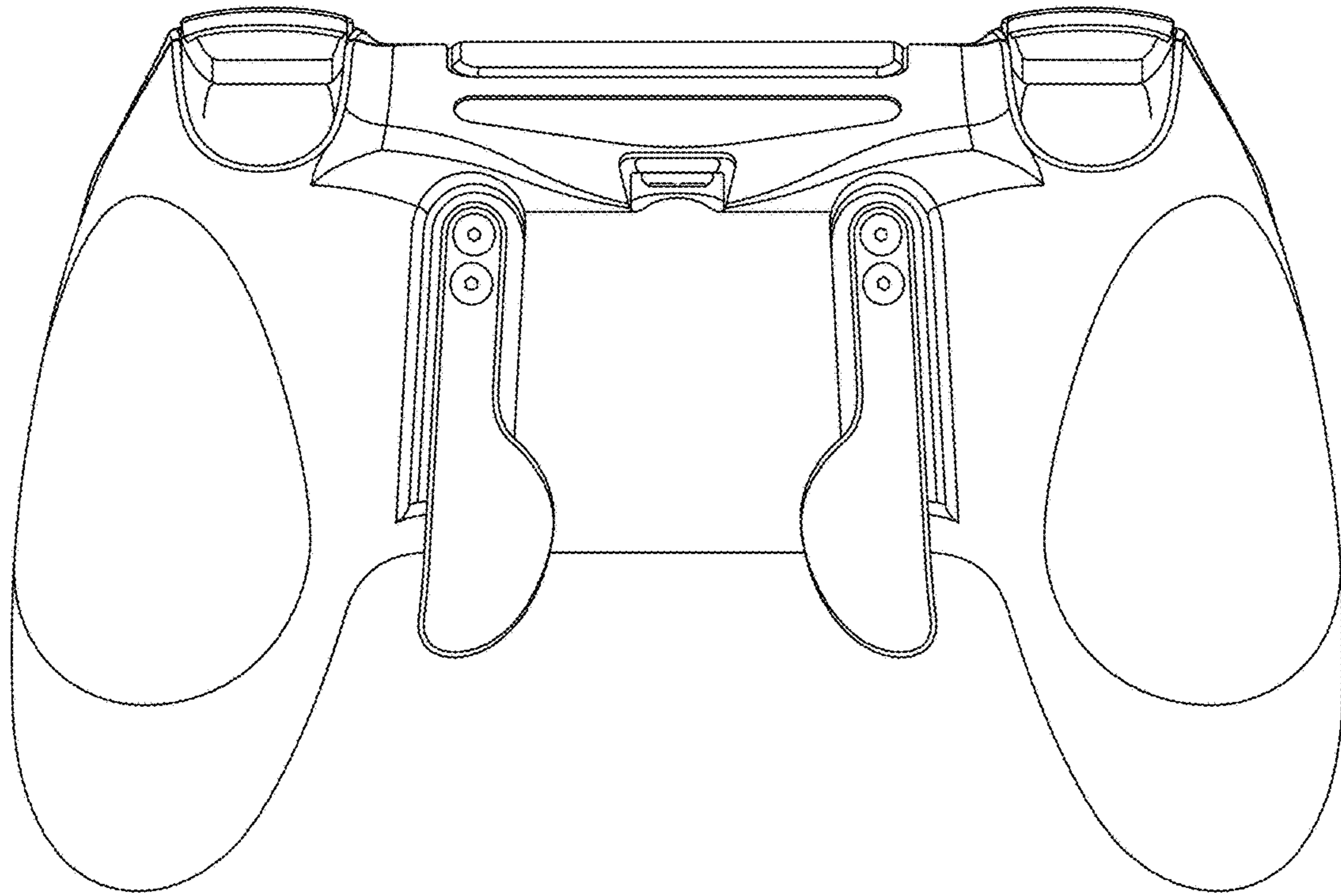

FIG. 3

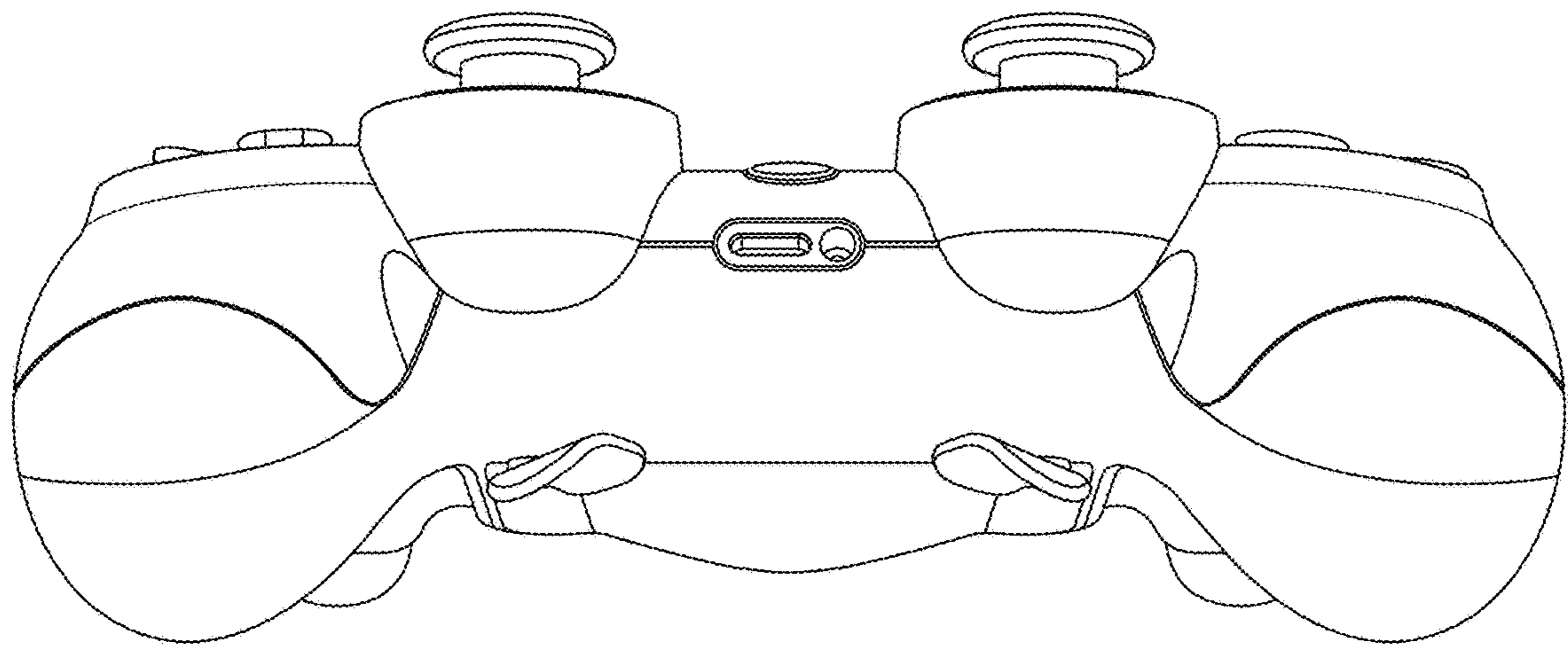

FIG. 4

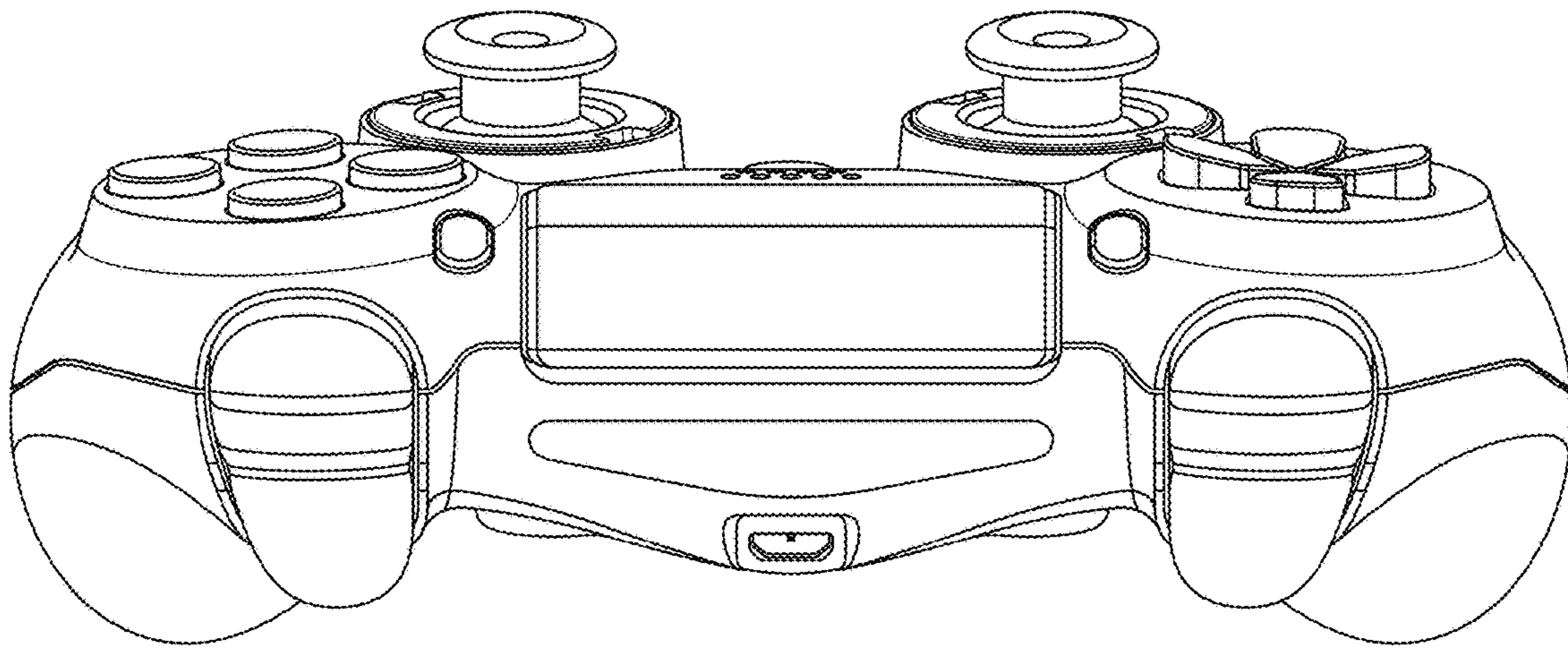

FIG. 5

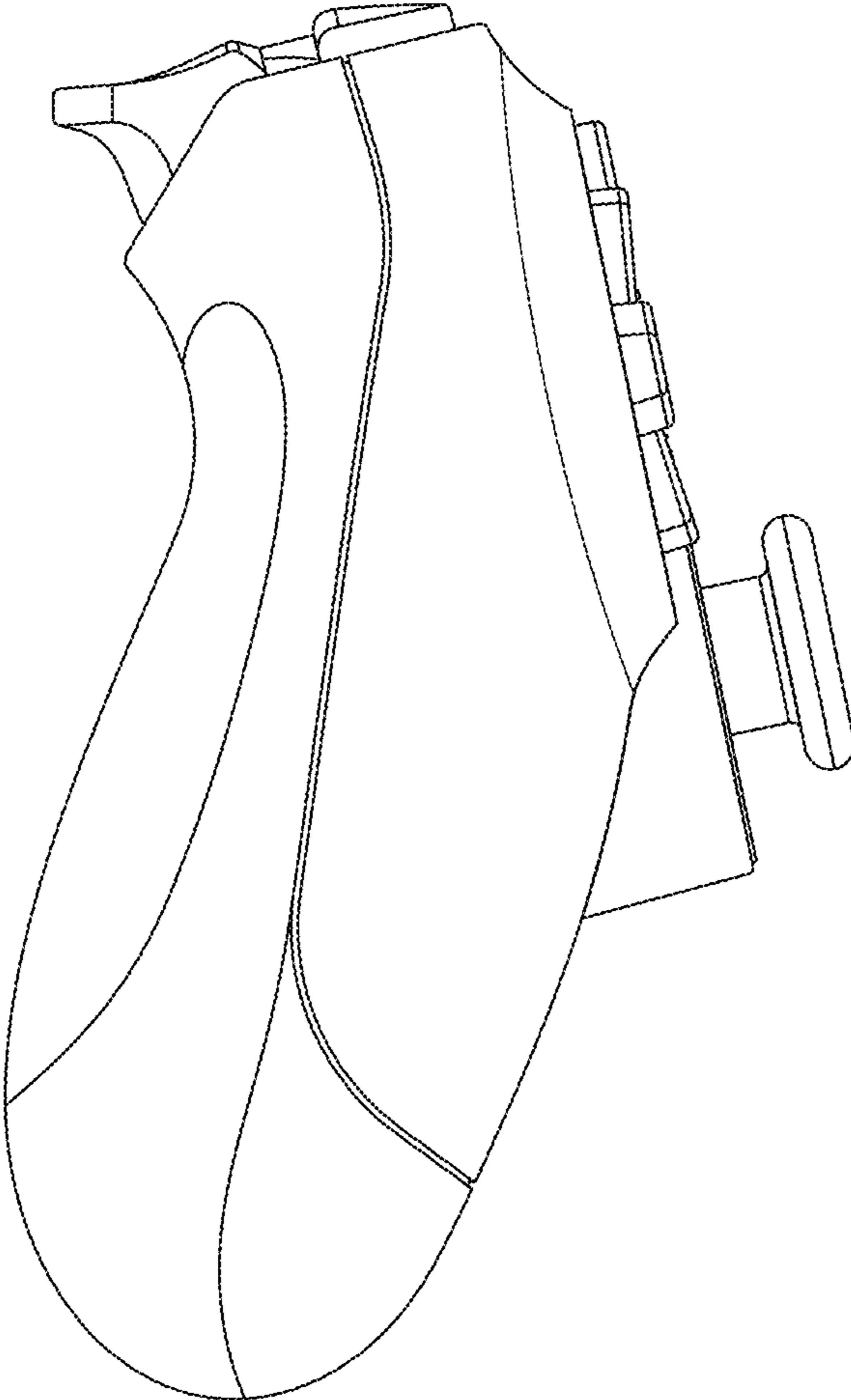

FIG. 6

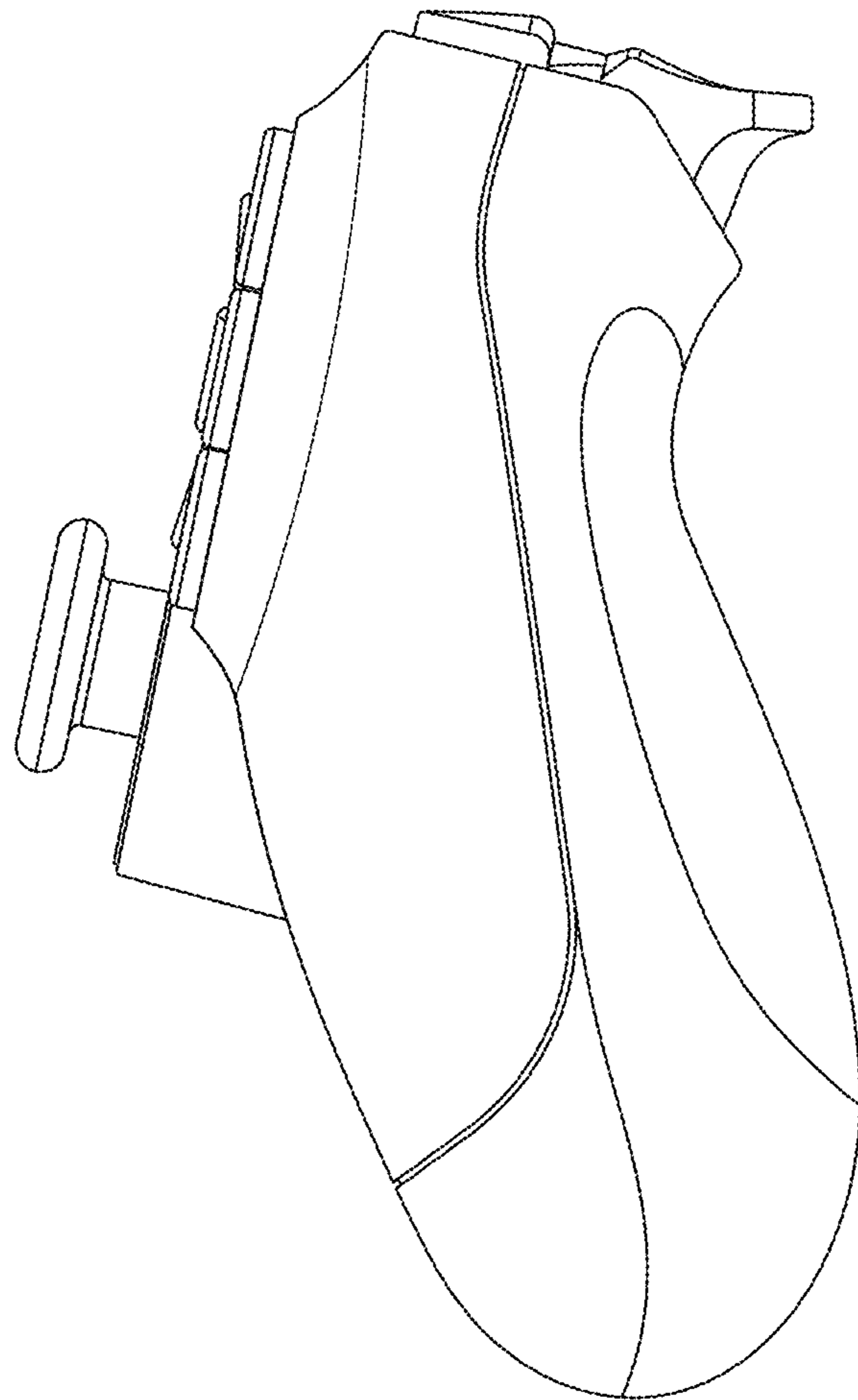

FIG. 7